



Catalog
LV 18

Edition
07/2022

SENTRON

Air Circuit Breakers and Molded Case Circuit Breakers with UL Certification

[siemens.com/lowvoltage](https://www.siemens.com/lowvoltage)

Innovative solutions for industrial controls and power distribution

In ensuring smooth operation of digital production environments and in the construction and operation of industrial or commercial buildings, the underlying power distribution and industrial controls are decisive:

SIRIUS, SENTRON, SIVACON and ALPHA provide a broad portfolio of systems and components for this purpose that can be used for standard-compliant, requirement-based electrification.

Efficient engineering tools and cloud-based solutions are part of the portfolio, which you can flexibly adapt to your specific requirements over the entire value-added process.

We are there when you need us

Your personal contact can be found at
www.siemens.com/lowvoltage/contact

Catalog LV 18 · 07/2022

You will find the latest edition and all future editions in the Siemens Industry Online Support at
www.siemens.com/lowvoltage/catalogs

Refer to the Industry Mall for current prices
www.siemens.com/industrymall



The products and systems described in this catalog are manufactured/distributed under application of a certified quality management system in accordance with EN ISO 9001 (for the Certified Registration Nos., see www.siemens.com/system-certificates/ep). The certificate is recognized by all IQNet countries.

Technical specifications

The technical specifications are for general information purposes only. Always heed the operating instructions and notices on individual products during assembly, operation and maintenance.

All illustrations are not binding.

© Siemens 2022

Air Circuit Breakers and Molded Case Circuit Breakers with UL Certification

	Introduction	I/2
Protecting	Air Circuit Breakers	1/1
	Molded Case Circuit Breakers	2/1
	Appendix	A/1

I

1

2

A

The fast route to the product

Overview of configurable products for better understanding

Molded Case Circuit Breakers | 3VA51 - 3VA47 | 3VA51 - 3VA47 | Molded Case Circuit Breakers

Structure of the article numbers

Basic configuration for line protection

The structure shown below is intended as an overview of each position and its meaning. For a complete and valid configuration of your molded case circuit breaker, please use our online configurator at www.siemens.com/lowvoltage/3va-47-configurator

		3VA	4	5	6	7	8	9	10	11	12	13	AA0
Trip units	Thermal-magnetic	1											
	Electronic	2											
Size	125 A												1
	150 A												2
	250 A												3
	400 A												4
	630 A												5
	800 A												6
	1000 A												7
	1200 A												8
	1600 A												9
	2000 A												0
Max. rated current L	15 A												1
	25 A												2
	30 A												3
	35 A												4
	40 A												5
	45 A												6
	50 A												7
	60 A												8
	70 A												9
	80 A												0
	90 A												1
	100 A												2
	110 A												3
	120 A												4
	130 A												5
Short circuit breaking capacity at 480 V 50/60 Hz	25 kA												4
	35 kA												5
	65 kA												6
	100 kA												7
	150 kA												8
	200 kA												9
	250 kA												0
	300 kA												1
	350 kA												2
	400 kA												3

		3VA	4	5	6	7	8	9	10	11	12	13	AA0
Protective function thermal-magnetic	Line protection												0
	100% neutral conductor protection												1
Protective function electronic	Line protection												2
	100% neutral conductor protection												3
Line protection, with delay	Line protection												4
	100% neutral conductor protection												5
	Line protection												6
	100% neutral conductor protection												7
Line protection, with delay, with measurement function	Line protection												8
	100% neutral conductor protection												9
	Line protection												0
	100% neutral conductor protection												1
Number of poles	1 pole												2
	2 poles												3
	3 poles												4
	4 poles												5
Connection technology	Without												6
	Nut keeper kit												7
Special specifications	Standard												8
	100% rated breaker												9

* Neutral conductor protection for 4-pole breakers
 ** Neutral conductor protection for 3-pole breakers with an external neutral conductor transformer or for 4-pole breakers
 † Only possible for 20kA
 ‡ Only possible for 40kA

† Available for breaking capacity classes M (25kA), H (35kA), C (100kA) and S (150kA) at 480 V
 ‡ Available for breaking capacity class S (200 kA) at 480 V

† Available - Not combination present

System overview, pages 248 and 212

System overview, pages 248 and 212

Siemens LV 18 - 07/2022

Configurable products

For products which are conveniently configurable online, the structure of the article numbers is clearly displayed. A link takes you directly to the configurator which permits complete and valid configuration.

Clickable article numbers

Direct forwarding to the individual products in the Industry Mall by clicking on the article number in the catalog

3VA9137-0EK11



or by entering this web address incl. article number
www.siemens.com/product?Article No.

new Search function

Search for new products by entering "new" in the text field of the search function



Overview of the key US standards

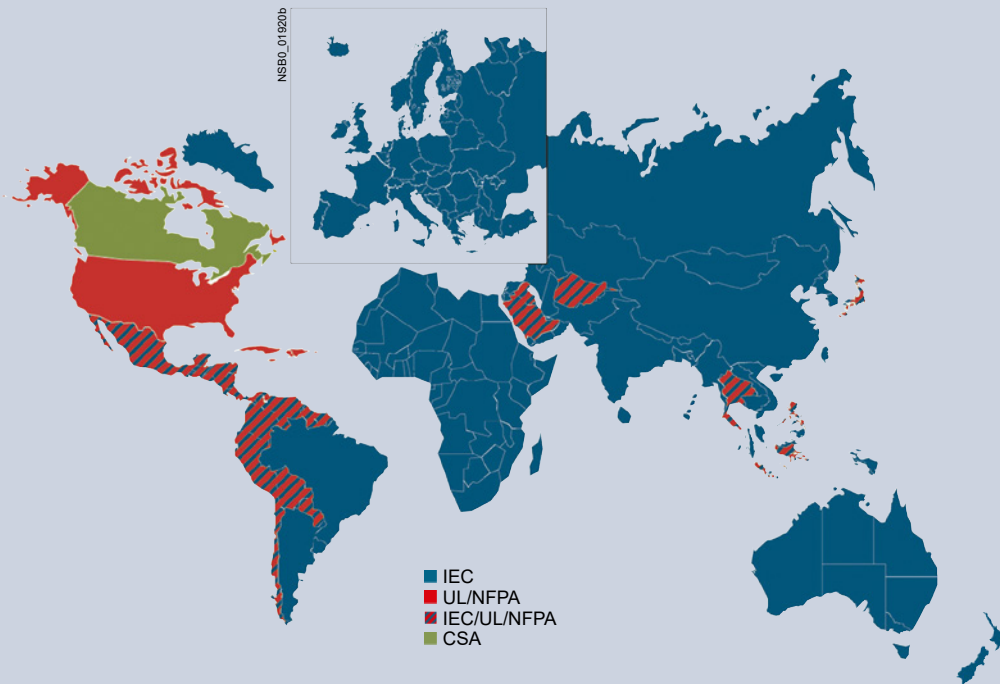





UL and IEC are fundamentally different. The IEC standards for the IEC market merely define the minimum safety requirements for a device or system. The technical details relating to how safety requirements are to be implemented are in practice a matter for the manufacturer. Every electrical machine or system in the USA is investigated by an inspector, the so-called Authority Having Jurisdiction (AHJ), prior to commissioning. The National Electrical Code (NEC), respective application-specific standards as well as local standards and specifications form the basis for acceptance.

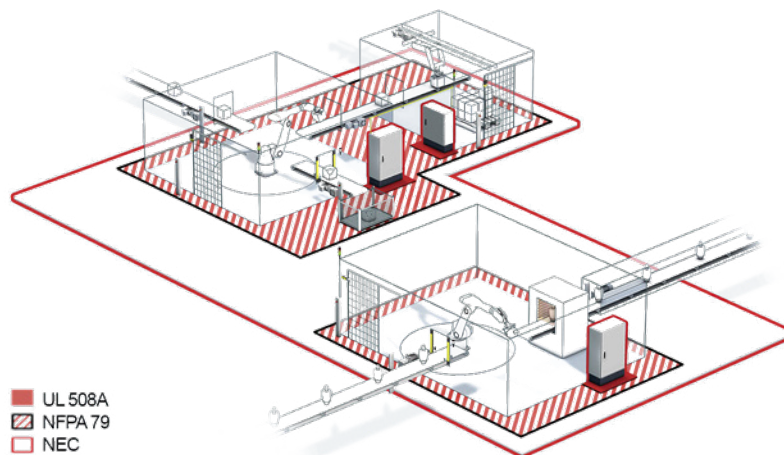

The following standards are of essential importance to mechanical engineers and panel builders:

- UL 508A for industrial control panels
- NFPA 79 (Electrical Standard for Industrial Machinery) for industrial machines
- NEC (National Electrical Code, NFPA 70) for electrical on-site installation



You will find further information at: www.siemens.com/controlpanel

Marks	Applications
	The UL Listing Mark is the most frequently used symbol. Products (e.g. washing machines, computers, electrical switchgear, fire extinguishers, personal flotation devices, etc.) which carry this mark meet all UL's safety requirements and are allowed to be installed universally and without further instruction or restriction of use. Our own portfolio, for example, offers contactors in accordance with UL 508 or circuit breakers in accordance with UL 489.
	C-UL Listing Mark: This mark is applied to products for the Canadian market. You will see this mark on appliances and computer equipment, vending machines, household burglar alarm systems, lighting fixtures, and many other types of products.
	C-UL US Listing Mark: Introduced in 1998, this mark indicates compliance of the products with both Canadian and U.S. requirements. The Canada/U.S. UL mark is optional. UL encourages those manufacturers with products certified for both countries to use this combined mark, but they may continue using separate UL marks for the United States and Canada.
	Recognized Component Mark: This mark is used on components and devices that are incorporated in machines, systems or products such as washing machines. These components may have restrictions on their performance or may be incomplete in construction. The Component Recognition Mark is found on a wide range of products, including some switches, power supplies, printed wiring boards, some kinds of industrial control equipment and many other products. They are allowed to be installed only by properly qualified personnel, as the "Conditions of Acceptability (CoA)" apply to these devices in all cases. Examples of our products that bear the UR mark include our miniature circuit breakers which meet UL 1077, our time switches which meet UL 917, and our SITOR fuses.
	Canadian Recognized Component Mark (similar to the Recognized Component Mark – see above): Components approved for the Canadian market carry this mark.
	Recognized Component Mark for Canada and the United States: Components carrying this mark, which became effective in 1998, meet the requirements of the US and Canadian markets for Recognized Components. Although UL had not originally planned to introduce a combined Recognized Component Mark, the popularity of Canada/U.S. listing marks among clients led to the new mark.

Certifications such as  and  are issued by the so-called NRTLs (Nationally Recognized Testing Laboratories) after successful testing. The OSHA (Occupational Safety and Health Administration) has accredited Underwriters Laboratories Inc. as an NRTL.

Overcurrent protection according to network standards

Overcurrent protection

The term "overcurrent" refers to the overload, short-circuit and ground-fault current when this exceeds the rated value of the protective device. Overcurrent protection is understood to be a device designed to open a circuit when the rated current is exceeded. The ampere rating of the device is selected for a circuit to terminate a condition where the current exceeds the rating of conductors and equipment due to overloads, short circuits and faults to ground.

UL 508A distinguishes between straight rating and slash rating. Which of these two ratings applies depends on the existing system type.

Slash rating

There are two voltages (phase – phase/phase – ground) in a solidly grounded wye network. These two voltages are also specified along with the rating, e.g. 480 Y/277 V. A device suitable for this network has a slash rating.

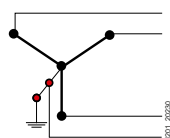

**3 phases,
4 conductors**

Solidly grounded wye, 3 phases, 4 conductors

Notice: The PE must not carry any current.
There is no PEN conductor --> N = grounded conductor (white or gray);
separate conductors must be used for PE and N.

Usable line voltages:

600Y/347 V ¹⁾
480Y/277 V ¹⁾
240Y/131 V ¹⁾
208Y/120 V ¹⁾

Straight rating

In the common industrial networks (see table) there is only one voltage. Such networks are called "straight networks". When choosing short-circuit protection devices, attention must be paid to whether devices are approved for straight or slash rating.

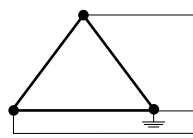

**3 phases,
3 conductors**

Corner grounded delta,
3 phases, 3 conductors

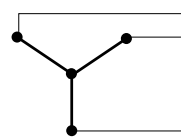

**3 phases,
3 conductors**

Ungrounded wye,
3 phases, 3 conductors

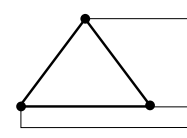

**3 phases,
3 conductors**

Ungrounded delta,
3 phases, 3 conductors

Usable line voltages:

600 V
480 V
240 V

¹⁾ Y describes the "Solidly grounded circuit". The value "Y" indicates the voltage between the phases (e.g. 480 V), and the value behind the slash indicates the voltage between the phase and the grounding or the neutral conductor (e.g. 277 V with 480 V voltage between the phases).

Brief code comparison of UL vs. IEC standards

Interaction of the most important US standards

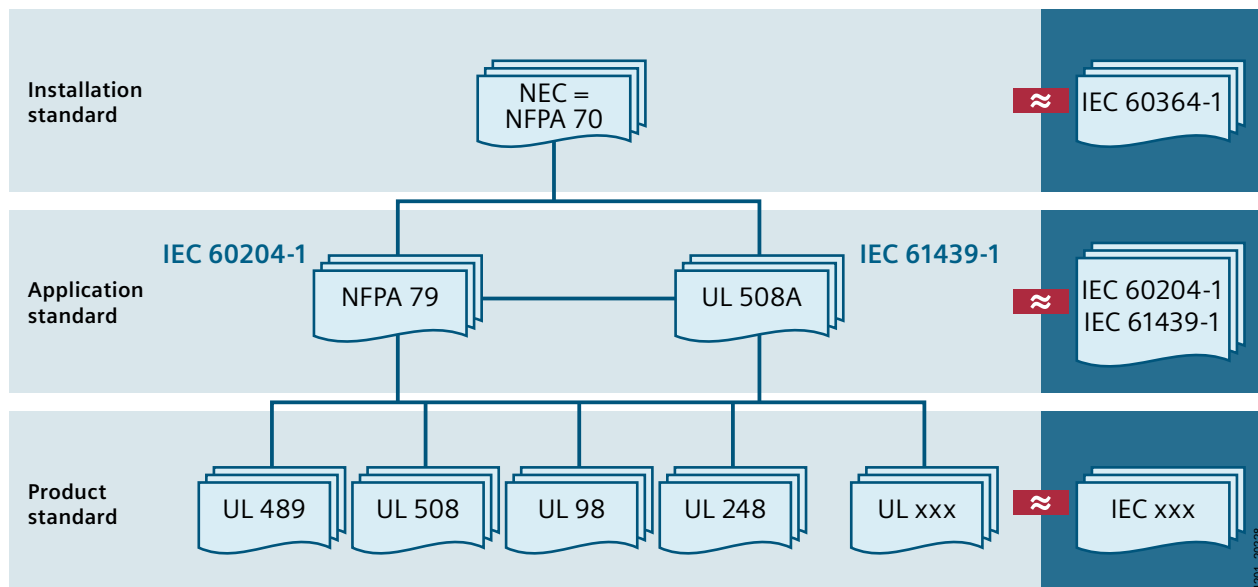

NEC = NFPA70 vs. IEC 60364-1: Electrical on-site installation

NFPA 79 vs. IEC 60204-1: Industrial machines

UL 508A vs. IEC 61439-1: Industrial control panels

Contact our Support at www.siemens.com/lowvoltage/certificates to find out which products (please specify the article number) are approved according to which standard.

The table below contains a summary of the available products and details of the UL, CSA and IEC standards with which the 3WL5 air circuit breaker and the 3VA5 and 3VA6 molded case circuit breakers comply. However, the table only contains product groups. The product groups mentioned might include individual products which are not approved according to UL or CSA. It is essential therefore to research each individual product via our Support.

	Size	UL Standard	CCN UL listed	UL recognized	UL File Nr.	CSA Standard	File Nr.	Class Nr.	IEC Standard
Air circuit breakers									
ACB	3WL5	≤5000 A	UL 489	DIVQ DIVQ7	–	E231263	cULus approved		IEC 60947-2
Molded case circuit breakers									
Circuit breaker (CB)	3VA51–3VA59	≤2000 A	UL 489	DIVQ DIVQ7	–	E364397	cULus approved		IEC 60947-2 ¹⁾
	3VA61–3VA69	≤2000 A	UL 489	DIVQ DIVQ7	–	E364397	cULus approved		IEC 60947-2 ¹⁾
Motor circuit protector (MCP)	3VA51–3VA55	≤800 A	UL 489	–	DKPU2 DKPU8	E482699	cULus approved		IEC 60947-2
	3VA61–3VA66	≤1000 A	UL 489	–	DKPU2 DKPU8	E482699	cULus approved		IEC 60947-2
Molded case switch (MCS)	3VA51–3VA59	≤2000 A	UL 489	WJAZ WJAZ7	–	E482701	cULus approved		IEC 60947-2 ¹⁾
	3VA61–3VA66	≤1000 A	UL 489	WJAZ WJAZ7	–	E482701	cULus approved		IEC 60947-2
Circuit breaker accessories	3VA9		UL 489	DIHS DIHS7	DIHS2 DIHS8	E354102	cULus approved		IEC 60947-2

¹⁾ No IEC approval for 3VA59 and 3VA69

Applications

Circuit breaker for line protection/ Inverse time circuit breaker for line protection (CB, CCN code: DIVQ)

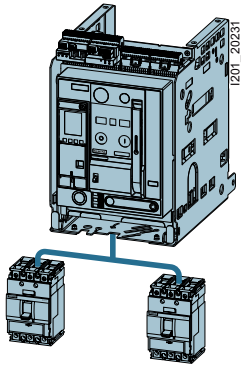

The trip units are designed to provide overload and short-circuit protection for:

- Cables
- Leads
- Non-motor loads

Non-automatic circuit breaker/ Switch disconnector/Molded case switch (MCS, CCN code: WJAZ)

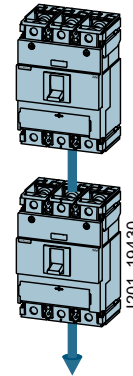

These molded case switches can be used as feeder switches, main switches or non-automatic circuit breakers without overload protection.

They incorporate an integrated short-circuit self-protection system.

Motor circuit protector/ Instantaneous trip circuit breaker/ Protective circuit breaker for motor starter combinations (MCP, CCN-Code: DKPU2)

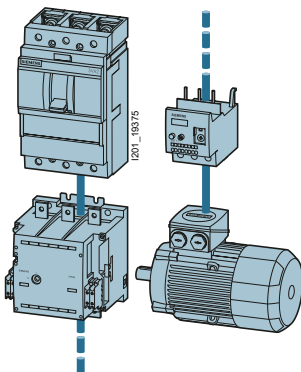

Starter combinations consist of:

Motor circuit protector + contactor + overload relay

The motor circuit protector handles short-circuit protection and the isolating function. The task of the contactor is the operational switching of the feeder. The overload relay handles overload protection that can be specially matched to the motor.

The motor circuit protector is therefore equipped with an adjustable and instantaneous short-circuit release.

Product approvals in control panel according to UL/NEC

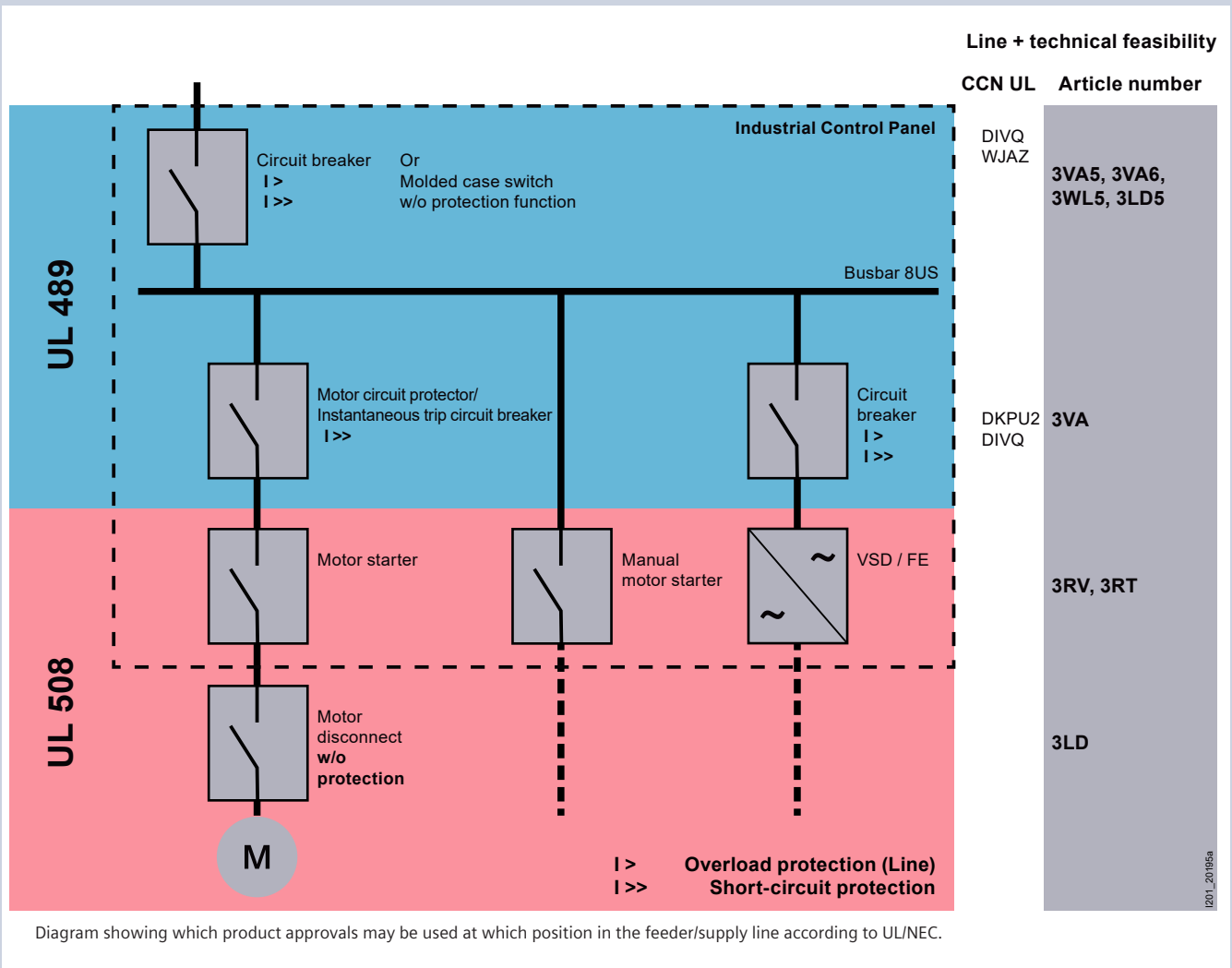

Reliable, versatile and perfectly integrated

All power distribution systems rely on a secure infeed of electrical energy. The 3WL air circuit breakers reliably protect electrical equipment from damage or fire resulting from short circuit, ground fault or overload failures.

The 3WL air circuit breakers are used as incoming-feeder, tie, and outgoing-feeder circuit breakers in electrical installations in industry, buildings and infrastructure applications. They have the ability to communicate and can easily be integrated into higher-level control and energy management systems.

The 3WL air circuit breakers switch and protect motors, capacitors, generators, transformers, busbars and cables. The modular design and standardized range of accessories enable the circuit breakers to be adapted flexibly to different applications. UL 489-compliant versions are available for international use.

The 3WL air circuit breakers can optionally be equipped with a communication module and integrated into higher-level energy management systems. Auxiliary, signaling and position switches report status and fault diagnostics remotely to higher-level control systems.



Air Circuit Breakers

1

All the information you need	1/2
Quick selection guide	1/4
Circuit breakers and non-automatic circuit breakers for AC and DC	1/4
Circuit breakers and non-automatic circuit breakers for AC	1/6
Non-automatic circuit breakers for DC	1/10
Electronic trip units ETU	1/12
Connection	1/14
Operating mechanism, auxiliary release, auxiliary switch	1/15
3WL5	1/16
System overview	1/16
Online configurator highlights	1/18
Structure of the article numbers	1/20
Accessory options	1/24
Guide frames for AC	1/34
Accessories and spare parts	1/35

A multitude of additional information ...

Information + ordering

All the important things at a glance

For information about air circuit breakers, please visit our website www.siemens.com/3WL

Siemens YouTube channel

- 3WL air circuit breakers (general) bit.ly/2ZH1rXH

Everything you need for your order

Refer to the Industry Mall for an overview of your products

- 3WL air circuit breakers/non-automatic air circuit breakers for AC up to 5000 A, UL sie.ag/2ScRZK7

Direct forwarding to the individual products in the Industry Mall by clicking on the article number in the catalog or by entering this web address incl. article number www.siemens.com/product?Article No.

Configurators

The configurator reduces the time and effort required in the planning and ordering process, and allows for individual adaptations. Configure your 3WL air circuit breaker at www.siemens.com/lowvoltage/3wl-configurator

The following are additionally available for your configured 3WL air circuit breaker:

- 3D views
- CAD data
- Unit wiring diagrams
- Dimension drawings

The fast track to the experts

Contact persons in your region

We offer a comprehensive portfolio of services. You can find your local contacts at www.siemens.com/lowvoltage/components/contact

You can find further information on services at www.siemens.com/service-catalog

Competent expert advice on technical questions with a wide range of demand-optimized services for all our products and systems.

Assistance with technical queries is provided at www.siemens.com/support-request

... can be found in our online services

Commissioning + operation

SENTRON powerconfig

The combined commissioning and service tool SENTRON powerconfig for communication-capable measuring devices, circuit protection devices and circuit breakers.

Free download SENTRON powerconfig via www.siemens.com/powerconfig

Free download SENTRON powerconfig mobile via [App Store](#) and [Play Store](#)

Your product in detail

The Siemens Industry Online Support (SIOS) provides detailed technical information

www.siemens.com/lowvoltage/product-support

- Operating instructions
- Characteristic curves
- Certificates

Comprehensive mobile support via the Siemens Industry Online Support app available for download from the [App Store](#) and [Play Store](#)

You will find further information under: www.siemens.com/support-app

Provision of 3D data (step and u3d data formats)

- Siemens Industry Mall www.siemens.com/lowvoltage/mall
- Image database www.siemens.com/lowvoltage/picturedb
- Engineering data for CAD or CAE systems are available in the CAx Download Manager at www.siemens.com/cax

Manuals

Manuals are available for downloading in Siemens Industry Online Support (SIOS) at www.siemens.com/lowvoltage/manuals

- Configuration manual
 - 3WL5 air circuit breakers/ non-automatic air circuit breakers **(109775570)**
- System manual
 - 3WL/3VL circuit breakers with communication capability – Modbus **(39850157)**
 - 3WL/3VL circuit breakers with communication capability – PROFIBUS **(12560390)**
- Communication manual
 - 3WL air circuit breakers via COM35 – PROFINET IO, Modbus TCP **(109757987)**

Face-to-face or online training

Our training courses can be found at www.siemens.com/sitrain-lowvoltage

- 3WL air circuit breakers, sizes 1-3 (WT-LVA3WL)
- Protection systems in low-voltage power distribution (WT-LVAPS)
- Maintenance and operation of 3WL circuit breakers (LV-CBMAIN) with subsequent certification option (LV-CBCERT)
- Communication with SENTRON components (LV-COM)
- Project planning and selection of SENTRON circuit breakers (LV-CBPROJ)

Video tutorial on the 3WL air circuit breaker

www.lowvoltage.siemens.com/wcms/3wl-tutorial

Technical overview – Air circuit breakers



The fast way to get you to our online services

This page provides you with comprehensive information and links on air circuit breakers

www.siemens.com/lowvoltage/product-support **(109766020)**

Circuit breakers and non-automatic circuit breakers for AC and DC

UL 489/IEC 60947-2

AC



3WL51

3WL52

Basic data		3WL51		3WL52	
Rated operational voltage U_e	V	600 Y/347		600	
Rated current I_n	A	630 ... 1600		2000 ... 3200	
Size		1		2	
Type of mounting		Withdrawable	Fixed-mounted	Withdrawable	Fixed-mounted
Number of poles		3/4-pole	3/4-pole	3/4-pole	3/4-pole
Dimensions					
Width (3-pole 4-pole)	mm	320 410	320 410	460 590	460 590
Height (standard A05, A15, A16, DC greater than 600 V)	mm	465.5	434	465.5	434
Depth	mm	471	291	471	291
Approvals					
General product approvals		VDE, UL/cULus, CE, CCC, EAC, C-Tick		VDE, UL/cULus, CE, CCC, EAC, C-Tick	
Breaking capacity		S		H	
Short-circuit breaking capacity acc. to UL 489					
Short-circuit breaking capacity up to 480 V AC $I_{cu} = I_{cs}$	kA	65		100	
Short-circuit breaking capacity up to 600 Y V/347 V AC $I_{cu} = I_{cs}$	kA	50		85 ¹⁾	
Short-circuit breaking capacity up to 600 V AC $I_{cu} = I_{cs}$	kA	–		85	
Short-circuit breaking capacity acc. to IEC 60947-2					
Short-circuit breaking capacity up to 500 V AC $I_{cu} = I_{cs}$	kA	65		100	
Short-circuit breaking capacity I_{cm} at 500 V AC $I_{cu} = I_{cs}$	kA	143		220	
Short-circuit breaking capacity up to 690 V AC $I_{cu} = I_{cs}$	kA	50		85	
Short-circuit breaking capacity I_{cm} at 690 V AC $I_{cu} = I_{cs}$	kA	105		187	
Rated short-time withstand current I_{cw} acc. to UL 489					
Rated short-time withstand current I_{cw} at max. delay time t_{sd}	0.4 s	kA	65	85	
Rated short-time withstand current I_{cw} acc. to IEC 60947-2					
Rated short-time withstand current I_{cw} at max. delay time t_{sd}	0.5 s	kA	65	85	
	1 s	kA	50	80	
Rated short-circuit current I_{cc} of the non-automatic air circuit breakers					
Rated short-circuit current I_{cc} at 600 V DC	kA	–		–	
Rated short-circuit current I_{cc} at 1000 V DC	kA	–		–	

¹⁾ Covered by 600 V AC (delta) test.

AC



DC

1

3WL53

3WL5232

≤600 Y/347		600
4000 ... 5000		3200
3		2
Withdrawable 3/4-pole	Fixed-mounted 3/4-pole	Fixed-mounted 3-pole
704 914	704 914	460
465.5	434	434
471	291	291
VDE, UL/cULus, CE, CCC, EAC, C-Tick		VDE, UL/cULus, CE, CCC, EAC, C-Tick
H		DC
100		–
85		–
–		–
100		–
220		–
85		–
187		–
85		–
85		–
80		–
–		25
–		–

Circuit breakers and non-automatic circuit breakers for AC

UL 489/IEC 60947-2

3WL51



Rated current I_n			≤ 1000 A	1600 A
General specifications				
Isolating function acc. to EN 60947-2			Yes	
Utilization category			B	
Permissible ambient temperature	Operation	°C	-25 ... +55	
	Storage	°C	-25 ... +70	
Mounting position				
Degree of protection	With cover		IP55	
	Without cover (with door sealing frame)		IP41	
Voltage				
Rated operational voltage U_e at 50/60 Hz			V AC	600 YI347
Permissible load at 50/60 Hz				
For main conductors	At 40 °C	A	≤ 1000	1600
	At 55 °C	A	≤ 1000	1600
	At 60 °C	A	≤ 1000	1600
Power loss at I_n				
With 3-phase symmetrical load	Fixed-mounted circuit breaker	W	100	150
	Withdrawable circuit breaker	W	195	350
Switching times				
Make time		ms	35	
Opening time		ms	38	
Electrical make time (through activation solenoid) ¹⁾		ms	80	
Electrical opening time (through shunt trip)		ms	73	
Electrical opening time (instantaneous undervoltage release)		ms	≤ 80	
Opening time due to ETU, instantaneous short-circuit release		ms	50	
Service life/endurance				
Mechanical	Without maintenance	Operating cycles	10000	
Electrical	Without maintenance	Operating cycles	4000	
Switching frequency				
Mechanical / electrical		1/h	60	
Minimum pauses				
Between tripping by the electronic trip unit and the next closure of the circuit breaker (only with automatic mechanical reset of the reclosing lockout)		ms	80	

¹⁾ Make time through closing coil for synchronization purposes (short-time excited) 50 ms.

3WL52



3WL53



2000 A	2500 A	3000 A	3200 A	4000 A	5000 A
--------	--------	--------	--------	--------	--------

Yes

Yes

B

B

-25 ... +55

-25 ... +55

-25 ... +70

-25 ... +70

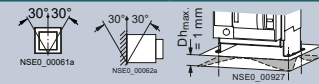
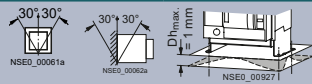

IP55

IP55

IP41

IP45

600

600

600

600

≤600 Y/347

2000

2500

3000

3200

4000

5000

2000

2500

3000

3200

4000

5000

2000

2500

3000

3200

4000

5000

180

270

410

410

520

630

320

520

710

710

810

1050

35

35

34

34

100

100

73

73

≤80

≤80

50

50

10000

10000

4000

1000

60

60

80

80

Circuit breakers and non-automatic circuit breakers for AC

UL 489/IEC 60947-2

3WL51



Rated current I_n		≤ 1000 A	1600 A
Connection			
Main conductor minimum cross-sections			
Copper bars, bare	Unit, mm ²	2 × 6.4 × 76.2	
Auxiliary conductor (Cu) max. number of auxiliary conductors × cross-section (solid/stranded)			
Standard connection = screw	Without end sleeve	2 × 0.5 ... 2 × 1.5 mm ² (AWG 20 ... 16); 1 × 2.5 mm ² (AWG 14)	
	With end sleeve acc. to DIN 46228 Part 2 ¹⁾	1 × 0.5 ... 1 × 1.5 mm ² (AWG 20 ... 16)	
	With twin end sleeve	2 × 0.5 ... 2 × 1.5 mm ² (AWG 20 ... 16)	
Screwless connection technology	Without end sleeve	2 × 0.5 ... 2 × 2.5 mm ² (AWG 20 ... 14)	
	With end sleeve acc. to DIN 46228 Part 2	2 × 0.5 ... 2 × 1.5 mm ² (AWG 20 ... 16)	
Minimum dimension of breaker compartment			
Width × height × depth	3-pole	mm	400 × 460 × 380
	3-pole with A17	mm	–
	4-pole	mm	500 × 460 × 380
Weights			
3-pole	Fixed-mounted circuit breaker	kg	43
	Withdrawable circuit breaker	kg	45
	Guide frames	kg	25
4-pole	Fixed-mounted circuit breaker	kg	50
	Withdrawable circuit breaker	kg	54
	Guide frames	kg	30

¹⁾ Notice: Approval of end sleeves.

3WL52



3WL53



2000 A	2500 A	3000 A	3200 A	4000 A	5000 A
2x 6.4 x 102	2x 6.4 x 127 or 4x 6.4 x 63.5	4x 6.4 x 102	4x 6.4 x 102	4x 10 x 120	
2x 0.5 ... 2x 1.5 mm ² (AWG 20 ... 16); 1x 2.5 mm ² (AWG 14)			2x 0.5 ... 2x 1.5 mm ² (AWG 20 ... 16); 1x 2.5 mm ² (AWG 14)		
1x 0.5 ... 1x 1.5 mm ² (AWG 20 ... 16)			1x 0.5 ... 1x 1.5 mm ² (AWG 20 ... 16)		
2x 0.5 ... 2x 1.5 mm ² (AWG 20 ... 16)			2x 0.5 ... 2x 1.5 mm ² (AWG 20 ... 16)		
2x 0.5 ... 2x 2.5 mm ² (AWG 20 ... 14)			2x 0.5 ... 2x 2.5 mm ² (AWG 20 ... 14)		
2x 0.5 ... 2x 1.5 mm ² (AWG 20 ... 16)			2x 0.5 ... 2x 1.5 mm ² (AWG 20 ... 16)		
500 x 460 x 380	500 x 460 x 380	500 x 460 x 380	500 x 460 x 380	800 x 460 x 380	800 x 460 x 380
–	560 x 570 x 500	–	560 x 570 x 500	810 x 570 x 500	–
600 x 460 x 380	600 x 460 x 380	–	560 x 570 x 500	1000 x 460 x 380	1000 x 460 x 380
56	59	64	64	82	
60	63	68	–	88	
31	39	45	–	60	
67	71	77	77	99	
72	76	82	–	106	
37	47	54	–	84	

Non-automatic circuit breakers for DC

UL 489/IEC 60947-2

3WL5232

3200 A

Rated current I_n				3200 A
General specifications				
Isolating function acc. to EN 60947-2			Yes	
Utilization category			B	
Permissible ambient temperature	Operation	°C	-25 ... +55	
	Storage	°C	-25 ... +70	
Mounting position				
Degree of protection	With cover		IP55	
	Without cover (with door sealing frame)		IP41	
Voltage				
Rated operational voltage U_e		V DC	600	
Permissible load				
For main conductors, acc. to IEC 60947-2	At 40 °C	A	3200	
	At 55 °C	A	3200	
	At 60 °C	A	3200	
For main conductors, acc. to UL 489B	At 40 °C	A	3200	
	At 55 °C	A	3200	
	At 60 °C	A	3200	
Power loss at I_n				
With 3-phase symmetrical load	Fixed-mounted circuit breaker	W	410	
	Withdrawable circuit breaker	W	-	
Switching times				
Make time		ms	35	
Opening time		ms	34	
Electrical make time (through activation solenoid) ¹⁾		ms	100	
Electrical opening time (through shunt trip)		ms	73	
Electrical opening time (instantaneous undervoltage release)		ms	≤80	
Opening time due to ETU, instantaneous short-circuit release		ms	50	
Service life/endurance				
Mechanical	Without maintenance	Operating cycles	10000	
Electrical	Without maintenance	Operating cycles	1000	
Switching frequency				
Mechanical / electrical		1/h	60	

¹⁾ Make time through activation solenoid for synchronization purposes (short-time excited) 50 ms.

3WL5232

3200 A

Rated current I_n

Connection			
Main conductor minimum cross-sections			
Copper bars, bare		Unit	4 × 6.4 × 102
Auxiliary conductor (Cu) max. number of auxiliary conductors × cross-section (solid/stranded)			
Standard connection = strain-relief clamp	Without end sleeve		2 × 0.5 ... 2 × 1.5 mm ² (AWG 20 ... 16); 1 × 2.5 mm ² (AWG 14)
	With end sleeve acc. to DIN 46228 Part 2 ²⁾		1 × 0.5 ... 1 × 1.5 mm ² (AWG 20 ... 16)
	With twin end sleeve		2 × 0.5 ... 2 × 1.5 mm ² (AWG 20 ... 16)
Optional connection = tension spring	Without end sleeve		2 × 0.5 ... 2 × 2.5 mm ² (AWG 20 ... 14)
	With end sleeve acc. to DIN 46228 Part 2		2 × 0.5 ... 2 × 1.5 mm ² (AWG 20 ... 16)
Weights			
3-pole	Fixed-mounted circuit breaker	kg	64
Dimensions 3/4-pole			
Fixed-mounted	Width	mm	460/590
	Height	mm	434
	Depth	mm	291
Withdrawable	Height	mm	465.5
	Depth	mm	471

²⁾ Notice: Approval of end sleeves.

1

Electronic trip units ETU

Available for air circuit breakers

1



Basic protective functions		ETU45B (LSI)	ETU45B (LSIG)
L Overload protection (L tripping)	Setting range of operating value $I_t = I_n \times \dots$	0.4 0.45 0.5 0.55 0.6 0.65 0.7 0.8 0.9 1	0.4 0.45 0.5 0.55 0.6 0.65 0.7 0.8 0.9 1
	Switchable overload protection (from I^2t - to I^4t -dependent function)	■	■
	Setting range of delay t_t at I^2t (Reference point $6 \times I_n$)	2 3,5 5,5 8 10 14 17 21 25 30 s	2 3,5 5,5 8 10 14 17 21 25 30 s
	Setting range of delay t_t at I^4t (Reference point $6 \times I_n$)	1 2 3 4 5 s	1 2 3 4 5 s
	Thermal memory can be switched on/off	■	■
	Phase failure sensitivity / asymmetry	At $t_{sd} = 20$ ms (M)	At $t_{sd} = 20$ ms (M)
S Short-time delayed short-circuit protection (ST tripping)	Setting range of operating value $I_{sd} = I_n \times \dots$	1.25 1.5 2 2.5 3 4 6 8 10 12	1.25 1.5 2 2.5 3 4 6 8 10 12 OFF
	Setting range of delay time t_{sd} at I^2t	100 200 300 400 ms	100 200 300 400 ms
	Setting range of delay time t_{sd} ($t = \text{const.}$)	M (0.02 ms) 100 200 300 400 ms	M (0.02 ms) 100 200 300 400 ms
	ZSI function	Via module of the CubicleBUS	Via module of the CubicleBUS
I Instantaneous short-circuit protection (INST tripping)	Setting range $2 = I_n \times \dots$	OFF 1,5 2,2 3 4 6 8 10 12 $0,8 \times I_{cs}$	OFF 1,5 2,2 3 4 6 8 10 12 $0,8 \times I_{cs}$
N Neutral conductor protection	Neutral conductor setting range $I_N = I_n \times \dots$	OFF 50 % 100 %	OFF 50 % 100 %
G Ground-fault tripping (GF tripping) Detection of ground-fault current through summation current formation with internal or external N conductor transformer	Tripping function can be switched on/off	–	■
	Alarm function can be switched on/off	–	–
	Detection of ground-fault current through external current transformer	–	■
	Setting range of the operating current $I_g = I_n \times \dots$	–	A ¹⁾ (100/400 A) B ¹⁾ (300/600 A); C ¹⁾ (600/800 A) D ¹⁾ (900/1000 A); E ¹⁾ (1200/1200 A)
	Setting range of the operating current I_g for alarm	–	A ¹⁾ (100/400 A); B ¹⁾ (300/600 A); C ¹⁾ (600/800 A); D ¹⁾ (900/1000 A); E ¹⁾ (1200/1200 A)
	Setting range of the delay time t_g	–	100 200 300 400 500 ms
	Switchable ground-fault protection characteristic (I^2t -dependent function)	–	■
	Setting range of delay time t_g at I^2t	–	100 200 300 400 500 ms
	ZSI-G function	–	Via module of the CubicleBUS

¹⁾ Sizes 1 and 2 / size 3



		ETU45B (LSI)	ETU45B (LSIG)
Parameter set changeover	Switchable between parameter set A and B	–	–
LCD		Optional	Optional
Voltage tap on top/bottom		Optional	Optional
Measurement function		Measurement function Plus	Measurement function Plus
Tripping as a result of extended protective function: (including: phase asymmetry current/voltage, harmonic distortion current/voltage, under/overvoltage, phase rotation direction, active power in/opposite to normal direction, under/over-frequency, protective functions dependent on direction of power flow)		■	■
Mode of communication			
Communication PROFIBUS PROFINET Modbus RTU Modbus TCP		■	■
Output modules			
Signals via relay: Overload warning, load shedding / load carrying, leading signal, overload tripping 200 ms, temperature alarm, phase asymmetry, instantaneous short-circuit release, short time-delayed short-circuit release, overload trip, neutral conductor trip, auxiliary relay, ETU faults, ground-fault protection tripping and ground-fault alarm (only with ground-fault protection module)		■	■

Connection

Main circuit connection

3WL5

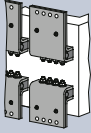
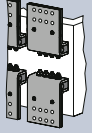
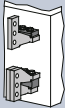
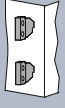
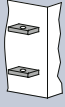
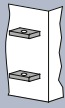
Connection	Fixed-mounted	Withdrawable
Front-mounted	 1-hole	 2-hole
Rear-mounted	 Vertical	 Vertical
	 Horizontal	 Horizontal

Auxiliary circuit connections

3WL5: Withdrawable version

- Connection of the internal auxiliary switches to the male connector on the switch side
- When fully inserted, connection with the sliding contact module in the guide frame

3WL5: Fixed-mounted version

- Engagement of the auxiliary supply connectors directly onto the circuit breaker

Coding pins on the connectors prevent them being inserted in the wrong slots

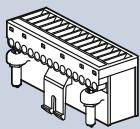

Screw connection (standard)

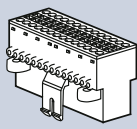

Screwless connection (tension spring) (optional)

Operating mechanism, auxiliary release, auxiliary switch

Operating mechanism

The circuit breakers are available with various optional operating mechanisms:

- Manual operating mechanism with mechanical closing (standard design)
- Manual operating mechanism with mechanical and electrical closing
- Motorized operating mechanism with mechanical and electrical closing

The operating mechanisms with electrical closing are suitable for synchronization tasks.

	Available for air circuit breakers 3WL5
Closing coils (CC)	■
Undervoltage releases (UVR)/ shunt trips (ST)	■
Shunt trips (ST)	■
Remote reset magnets (RR)	■
Motorized operating mechanism (MO)	■
Mechanical operating cycles counters	■

3WL5 system overview

UL 489 AC ..

For a complete and valid configuration of your air circuit breaker, please use our online configurator at www.siemens.com/lowvoltage/3wl-configurator

1

Circuit breakers and non-automatic circuit breakers



Sizes 1 to 3

Trip units



LSI



LSIG

Accessories



Communi-
cation
module



Rating plugs



Remote reset
magnets



Breaker status
sensors (BSS)



Ground-fault
modules

NSE0_01027a

Main conductor connections

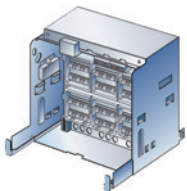

Fixed-mounted,
withdrawable versions



Main connection vertical,
horizontal, front, flange

Accessories



Auxiliary conductor plug-in system

Operating mechanisms and auxiliary releases

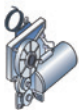

Motorized operating mechanisms

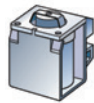

Auxiliary releases

Accessories



Closing coils

Note:

You will find a detailed range of accessories in the Accessories section.

Auxiliary switches

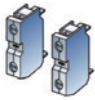

Auxiliary switches

Accessories

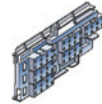

Position signaling switches

Further accessories



Door sealing frames

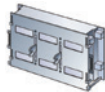

Shutters



EMERGENCY-OFF
pushbuttons



Operating cycle
counters



Support brackets



Grounding connections

Interlocking



Interlocking sets



Key operation

Note:

You will find a detailed range of accessories in the Accessories section.

Online configurator highlights

www.siemens.com/lowvoltage/configurators

Search function with global direct input

Searches for specific terms and jumps to MLFB based on input to the correct configurator

SIEMENS
Ingenuity for Life

Log in Additional actions Support Language

Configurators for Low-voltage

Search for (e.g. 3WL1110-4E836-6EQ8-Z A05+80...)

1 Select Type of Product

2 Select Category

Product list stores multiple configurations and can transfer them collectively to the shopping cart

List of products

Projectdata

Load product list

Actions

No.	Article	Quantity	Unit price:	Documents		
1	3WL5110-3FB32-1AA2-Z B02+M41 fixed-mounted circuit breaker approved to UL489 3-pole, BG I, In=1000A AC 50/60 Hz, IEC: to 690V, 65kA at 440V ul: to 600y... Further details	1 Piece	on request	> all documents for position	...	

Recall of completed configurations for modification or additional configuration

List of products

Projectdata

Load product list

Actions

No.	Article	Quantity	Unit price:	Documents		
1	3WL5110-3FB32-1AA2-Z B02+M41 fixed-mounted circuit breaker approved to UL489 3-pole, BG I, In=1000A AC 50/60 Hz, IEC: to 690V, 65kA at 440V ul: to 600y... Further details	1 Piece	on request	> all documents for position	...	

Responsive Design

SIEMENS
Ingenuity for Life

Log in Additional actions Support Language

Configurators for Low-voltage

Search for (e.g. 3WL1110-4E836-6EQ8-Z A05+80...)

1 Select Type of Prod...

2 Select Category



MCCB - molded case circuit breaker



ACB - air circuit breaker



Additional products

www.siemens.com/lowvoltage/3wl-configurator

Download an ePlan Selector for 3WL5

The configuration is complete. You can order this product.

Basic breaker | ETU | Connection | Motor and auxiliary releases | Auxiliary switches | Accessories | Locking | Result | CAD/CAE | 15.3

3WL5110-3FB32-1AA2-Z...

Wire frame view | Area Model

Documentation and reporting

Choose languages for the data sheet: deutsch

Project data for the datasheet

Download selection of document types

Data sheets (PDF)

Selection of download format

All in a ZIP file

Start generation

Component documentation

3WL5110-3FB32-1AA2 Z B02

Datasheet (PDF)

© Siemens AG | Application information

Download - quick links

3WL5110-3FB32-1AA2-Z...

Click2CAD

Download - all CAD formats

View: Wire frame view

View option: Isometric

File type: Joint Photography Experts Group (*.jpg)

Start generation

Download - all documents

open documents dialog

Mouseover display of characteristic curves to show the protection function

The configuration is not complete, please set all orange values.

Basic configuration | Trip units | Main connection | Motor | Auxiliary release | Closing coil | 2019_08.02

Choose value:

Trip units	Protective function	Communication capability	Metering capability	Display
Non-automatic breaker	-	-	-	-
ETU120	II	-	-	-
ETU250	III	-	-	-
ETU360	-	-	-	-
ETU450	-	yes	yes	yes
ETU460	-	yes	yes	yes

Graph showing characteristic curves (I, I_n, I_r) and time (t).

Direct entry of an already known MLFB or parts of an MLFB

3WL Air Circuit Breakers

Product Information

Configurators

Select a Configurator: 3WL10 Air Circuit-Breakers, FS0

3WL10 Air Circuit-Breakers, FS0

Selection - Tool for air circuit breakers (ACB) SENTRON 3WL10 from 630 A to 1250 A

- for selective line protection
- for motor protection
- non-automatic circuit breaker



Using this configurator, you can precisely select the optimum circuit breaker configuration for your application. Comprehensive CAX-data support of the device is provided after successful configuration.

Start

MLFB direct input (complete): 3WL1010-2CE41-0AA0

Start

Structure of the article numbers

Basic configuration for AC circuit breakers

The structure shown below is intended as an overview of each position and its meaning. For a complete and valid configuration of your air circuit breaker, please use our online configurator at www.siemens.com/lowvoltage/3wl-configurator

		5	6	7	8	9	10	11	12	13	14	15	16
		3WL5			-								
Circuit breaker and ETU													
Size (SZ)		1											
		2											
		3											
			SZ 1	SZ 2	SZ 3								
Max. rated current I_n	1000 A	■	-	-	1	0							
	1600 A	■	-	-	1	6							
	2000 A	-	■	-	2	0							
	2500 A	-	■	-	2	5							
	3000 A	-	■	-	3	0							
	3200 A	-	■ ¹⁾	-	3	2							
	4000 A	-	-	■	4	0							
5000 A	-	-	■	5	0								
Short-circuit breaking capacity I_{cu} at 480 V	S Standard	■	-	-	≤65 kA	3							
	H High	-	■	■	≤100 kA	4							
Trip units	Without electronic trip unit						A	A					
	Without ground-fault protection	ETU45B			LSIN		E	B					
		ETU45B (with display)			LSIN		F	B					
	With ground-fault protection	ETU45B			LSING		E	G					
ETU45B (with display)				LSING		F	G						
Number of poles	3-pole								3				
	4-pole								4				
Connection			SZ 1	SZ 2	SZ 3								
Type of mounting	Fixed-mounted	■	■	■	Vertical	1							
		■	■ ²⁾	■	Horizontal	2							
		■	■ ²⁾	■ ³⁾	Front single hole	3							
		■	■ ²⁾	■ ³⁾	Front double hole	4							
	Withdrawable	■	■ ²⁾	■	Without frame	5							
		■	■ ²⁾	■	Rear horizontal connection	6							
		■	■ ²⁾	■	Rear vertical connection	7							
		■	■ ²⁾	■ ³⁾	Connecting flange	8							

¹⁾ For fixed-mounted versions only

²⁾ Not available for 3200 A

³⁾ Not available for 5000 A

3WL5

5	6	7	8	9	10	11	12	13	14	15	16
---	---	---	---	---	----	----	----	----	----	----	----

Motor

Stored energy mechanism	Manual recharging of the stored energy mechanism	With mechanical operation		1	
		With mechanical and electrical operation, closing coil suitable for uninterrupted duty, 100% OP	110 V AC 50/60 Hz/110 ... 125 V DC 240 V AC 50/60 Hz/220 V DC	2 3	
		Motorized recharging	With mechanical and electrical operation, closing coil suitable for uninterrupted duty, 100% OP	208 ... 240 V AC 50/60 Hz/220 ... 250 V DC 110 ... 127 V AC 50/60 Hz/110 ... 125 V DC 24 V DC	4 5 6
	1st auxiliary release	Without 1st auxiliary release			A
		With shunt trip (ST) 100% OP	24 V DC		B
			30 V DC		C
48 V DC				D	
60 V DC				E	
110 ... 127 V AC, 110 ... 125 V DC				F	
208 ... 240 V AC, 220 ... 250 V DC				G	
2nd auxiliary release	Without 2nd auxiliary release			A	
	With shunt trip (ST) 100% OP	24 V DC		B	
		30 V DC		C	
		48 V DC		D	
		60 V DC		E	
		110 ... 127 V AC 50/60 Hz/110 ... 125 V DC		F	
		208 ... 240 V AC 50/60 Hz/220 ... 250 V DC		G	
		With undervoltage release (UVR), instantaneous	24 V DC		J
	30 V DC			K	
	48 V DC			L	
	60 V DC			U	
	110 ... 127 V AC 50/60 Hz/110 ... 125 V DC			M	
	208 ... 240 V AC 50/60 Hz/220 ... 250 V DC			N	
With undervoltage release (UVR), delay 0.2 ... 3.2 s	48 V DC		Q		
	110 ... 127 V AC 50/60 Hz/110 ... 125 V DC		R		
	208 ... 240 V AC 50/60 Hz/220 ... 250 V DC		S		

Auxiliary switches

1st auxiliary switch block	2 NO + 2 NC	2
1st + 2nd auxiliary switch block	4 NO + 4 NC	4
	6 NO + 2 NC	7
	5 NO + 3 NC	8

Structure of the article numbers

Basic configuration for DC non-automatic circuit breakers

The structure shown below is intended as an overview of each position and its meaning. For a complete and valid configuration of your air circuit breaker, please use our online configurator at www.siemens.com/lowvoltage/3wl-configurator

	5	6	7	8	9	10	11	12	13	14	15	16
3WL5				-					-			
Non-automatic circuit breaker and ETU												
Size (SZ)	2 ¹⁾											
Max. rated current I_n	3200 A	3	2									
Short-circuit breaking capacity I_{cu}	25 kA at 690 V			8								
Non-automatic air circuit breaker	Without electronic trip unit				A	A						
Number of poles	3-pole							3				
Connection												
Type of mounting	Fixed-mounted				Vertical				1			
					Horizontal				2			

¹⁾ Can also be used for variable frequencies of 0 ... 30 Hz. Z option A17 must always be ordered additionally.

3WL5

5	6	7	8	9	10	11	12	13	14	15	16
---	---	---	---	---	----	----	----	----	----	----	----

Motor

Stored energy mechanism	Manual recharging of the stored energy mechanism	With mechanical operation		1	
		With mechanical and electrical operation, closing coil suitable for uninterrupted duty, 100% OP	110 V AC 50/60 Hz/110 ... 125 V DC 240 V AC 50/60 Hz/220 V DC	2 3	
		Motorized recharging	With mechanical and electrical operation, closing coil suitable for uninterrupted duty, 100% OP	208 ... 240 V AC 50/60 Hz/220 ... 250 V DC 110 ... 127 V AC 50/60 Hz/110 ... 125 V DC 24 V DC	4 5 6
	1st auxiliary release	Without 1st auxiliary release			A
		With shunt trip (ST) 100% OP	24 V DC		B
			30 V DC		C
48 V DC				D	
60 V DC				E	
110 ... 127 V AC, 110 ... 125 V DC				F	
208 ... 240 V AC, 220 ... 250 V DC				G	
2nd auxiliary release	Without 2nd auxiliary release			A	
	With shunt trip (ST) 100% OP	24 V DC		B	
		30 V DC		C	
		48 V DC		D	
		60 V DC		E	
		110 ... 127 V AC 50/60 Hz/110 ... 125 V DC		F	
		208 ... 240 V AC 50/60 Hz/220 ... 250 V DC		G	
		With undervoltage release (UVR), instantaneous	24 V DC		J
	30 V DC			K	
	48 V DC			L	
	60 V DC			U	
	110 ... 127 V AC 50/60 Hz/110 ... 125 V DC			M	
	208 ... 240 V AC 50/60 Hz/220 ... 250 V DC			N	
	With undervoltage release (UVR), delay 0.2 ... 3.2 s		48 V DC		Q
110 ... 127 V AC 50/60 Hz/110 ... 125 V DC			R		
208 ... 240 V AC 50/60 Hz/220 ... 250 V DC			S		

Auxiliary switches

1st auxiliary switch block	2 NO + 2 NC	2
1st + 2nd auxiliary switch block	4 NO + 4 NC	4
	6 NO + 2 NC	7
	5 NO + 3 NC	8

Accessory options

For a complete and valid configuration of your air circuit breaker, please use our online configurator at www.siemens.com/lowvoltage/3wl-configurator

To specify the options, add "-Z" to the complete article number and indicate the appropriate order code(s).

3WL....-.....-.... -Z

Order code

Accessories for basic configuration

IT network capability at 690 V AC + 10% according to IEC 60947-2 Annex H

Rated operational voltage AC	Size	Article number	Order code
	Size 2	3WL5225-4..31-...	A17
		3WL5225-4..32-...	A17
		3WL5232-4..31-...	A17
	Size 3	3WL5340-4..31-...	A17
		3WL5340-4..32-...	A17
		3WL5350-4..31-...	A17
		3WL5350-4..32-...	A17
Rated operational voltage DC	Size 2	3WL5232-8AA31-...	A17
		3WL5232-8AA32-...	A17

Accessories for electronic trip units ETU

Rating plugs

- Only one module is possible per circuit breaker.
- As standard, the electronic trip units are equipped with a rating plug which is equal to the maximum rated circuit breaker current ($I_{n \max}$). The rated current of the selected rating plug must be less than $I_{n \max}$.

Module	Sizes	Rating (A)	Order code
	Sizes 1, 2	250 A	B02
		315 A	B03
		400 A	B04
		500 A	B05
		630 A	B06
		800 A	B08
		1000 A	B10
	Sizes 1, 2, 3	1250 A	B12
		1600 A	B16
	Sizes 2, 3	2000 A	B20
		2500 A	B25
		3000 A	B30
		3200 A	B32
	Size 3	4000 A	B40
		5000 A	B50

Communication and measurement function

Function	Description	Order code
Breaker status sensor (BSS)	For determining the statuses ON/OFF/Tripped	F01
PROFIBUS DP communication port ¹⁾	Including COM15 and breaker status sensor (BSS)	F02
Modbus RTU communication port ¹⁾	Including COM16 and breaker status sensor (BSS)	F12
PROFINET IO/Modbus TCP communication port ¹⁾	Including COM35 and breaker status sensor (BSS)	F35
Measurement function Plus ²⁾	Without communication module	F05

¹⁾ When ordering withdrawable circuit breaker and guide frame separately, specify order code "F02", "F12" or "F35" only for withdrawable circuit breaker.

²⁾ Additional voltage transformers are always required for connection of the measurement function Plus, e.g. GE Grid Solutions Model 468.

To specify the options, add "-Z" to the complete article number and indicate the appropriate order code(s).

3WL.....-.....-..... -Z

Order code

Accessories for electronic trip units ETU

EMC filter

- Common-mode interference suppressor filters (e.g. in IT networks, caused by frequency converters)
- Insertion loss (asymmetric) in the range 40 kHz to 10 MHz >40 dB.

EMC filter			F31
------------	--	--	-----

Overload and short-circuit protection for neutral conductors

- Only possible with 4-pole circuit breaker with ETU45B

Internal current transformer for N conductor	Size 1		F23
	Size 2		F23
	Size 3		F23

Remote resetting

Automatic reset of the reclosing lockout

- Remote reset for displays and reset buttons including automatic reset of the reclosing lockout

Remote reset magnets	24 ... 30 V DC		K10
	48 ... 60 V DC		K11
	120 V AC 50/60 Hz/125 V DC		K12
	208 ... 250 V AC 50/60 Hz/208 ... 250 V DC		K13

Connection

Connection technology for main connections (fixed-mounted versions)

Top: ¹⁾ horizontal Bottom: accessible from front, single hole	Size 1	≤1600 A	N11
	Size 2	≤2000 A	N11
		≤2500 A	N11
		≤3200 A	N11
	Size 3	≤4000 A	N11
Top: vertical Bottom: horizontal	Size 1	≤1600 A	N20
		≤2000 A	N20
		≤2500 A	N20
	Size 2	≤2000 A	N20
		≤2500 A	N20
		≤3200 A	N20
		≤4000 A	N20
Top: horizontal Bottom: vertical	Size 1	≤1600 A	N24
		≤2000 A	N24
		≤2500 A	N24
	Size 2	≤2000 A	N24
		≤2500 A	N24
Size 3	≤3200 A	N24	
	≤4000 A	N24	
	≤5000 A	N24	

¹⁾ Cannot be used for DC non-automatic air circuit breakers and circuit breakers with the Z option A17.

Accessory options

For a complete and valid configuration of your air circuit breaker, please use our online configurator at www.siemens.com/lowvoltage/3wl-configurator

To specify the options, add "-Z" to the complete article number and indicate the appropriate order code(s).

3WL....-.....-.... -Z

Order code

Connection

Connection technology for main connections (withdrawable versions)

Top and bottom: accessible from front, single hole	Size 1	≤1600 A	P00
	Size 2	≤3200 A	P00
	Size 3	≤4000 A	P00
Top and bottom: accessible from front, double hole	Size 1	≤1600 A	P01
	Size 2	≤3200 A	P01
	Size 3	≤4000 A	P01
Top: horizontal Bottom: accessible from front, single hole	Size 1	≤1600 A	P07
	Size 2	≤3200 A	P07
	Size 3	≤4000 A	P07

Connection technology for main connections (withdrawable versions)

Top: vertical Bottom: horizontal	Size 1	≤1600 A	P18
	Size 2	≤3200 A	P18
	Size 3	≤5000 A	P18
Top: connecting flange Bottom: horizontal	Size 1	≤1600 A	P19
	Size 2	≤3200 A	P19
	Size 3	≤4000 A	P19
Top: horizontal Bottom: vertical	Size 1	≤1600 A	P23
	Size 2	≤3200 A	P23
	Size 3	≤5000 A	P23
Top: horizontal Bottom: connecting flange	Size 1	≤1600 A	P28
	Size 2	≤3200 A	P28
	Size 3	≤4000 A	P28

Connection technology for auxiliary conductors (for fixed-mounted and withdrawable circuit breakers)

Connection technology for screwless terminals (tension spring)	Fixed-mounted	N61
	Withdrawable	P61

To specify the options, add "-Z" to the complete article number and indicate the appropriate order code(s).

3WL.....-.....-..... -Z

Order code

Operating mechanisms and auxiliary releases

Motorized operating mechanisms	Only possible if the 13th digit of the Article number = "1"	24 ... 30 V DC	M01
		48 ... 60 V DC	M03
		110 ... 127 V AC 50/60 Hz/110 ... 125 V DC	M05
		208 ... 240 V AC 50/60 Hz/220 ... 250 V DC	M06
Mechanical operating cycles counter, 5-digit¹⁾			C01
Closing coils	<ul style="list-style-type: none"> Suitable for uninterrupted duty, 100% OP Only possible if the 13th digit of the Article number = "1" 	24 V DC	M21
		30 V DC	M22
		48 V DC	M23
		60 V DC	M24
		110 ... 127 V AC 50/60 Hz/110 ... 125 V DC	M25
	208 ... 240 V AC 50/60 Hz/220 ... 250 V DC	M26	
	<ul style="list-style-type: none"> Not suitable for uninterrupted duty, 5% OP, synchronizable³⁾ Only possible if the 13th digit of the Article number = "1" 	24 V DC	M31
		48 V DC	M33
		110 ... 127 V AC 50/60 Hz/110 ... 125 V DC	M35
		208 ... 240 V AC 50/60 Hz/220 ... 250 V DC	M36
Opening coils (shunt trips)²⁾³⁾	Not suitable for uninterrupted duty, 5% OP, synchronizable	24 V DC	M41
		48 V DC	M43
		110 ... 127 V AC 50/60 Hz/110 ... 125 V DC	M45
		208 ... 240 V AC 50/60 Hz/220 ... 250 V DC	M46

Auxiliary switches and signaling switches

Position signaling switches for guide frames	1 CO 1 CO 1 CO (connected test disconnected position)	R15	
	3 CO 2 CO 1 CO (connected test disconnected position)	R16	
Signaling switches	Ready-to-close signaling switch (S20)	1 NO	C22
	Spring charge signaling switch ⁴⁾ (S21)	1 NO	C20
	For the first auxiliary release ⁵⁾ (S22)	1 CO	C26
	For the second auxiliary release ⁵⁾ (S23)	1 CO	C27
	1st tripped signaling switch ⁴⁾⁶⁾ (S24)	1 CO	K07
2nd tripped signaling switch ⁴⁾⁵⁾⁶⁾ (S25)	1 NO	K06	

¹⁾ Only possible with motorized operating mechanism.

²⁾ Only possible if the 14th digit of the Article number for the circuit breaker is "A", i.e. "without 1st auxiliary release".

³⁾ Overexcited, i.e. switching time 50 ms (standard >80 ms).

⁴⁾ Not possible with "communication port" option, order code "F02", "F12" or "F35".

⁵⁾ Only possible with option "K07".

⁶⁾ Not available for non-automatic air circuit breakers.

Accessory options

For a complete and valid configuration of your air circuit breaker, please use our online configurator at www.siemens.com/lowvoltage/3wl-configurator

To specify the options, add "-Z" to the complete article number and indicate the appropriate order code(s).

3WL.....-.....-..... -Z

Order code

Further accessories

Pushbuttons/shutdown switches/closing lockouts

EMERGENCY-OFF pushbuttons	Mushroom pushbutton instead of the mechanical OFF pushbutton		S24
Electrical ON button on operator panel ¹⁾(S10)	This prevents unauthorized electrical closing from the operator panel. Mechanical closing and remote closing remain possible. Possible only for circuit breakers with closing coil (CC)	With sealing cap	C11
		With CES lock	C12
Motor shutdown switch on operator panel ²⁾(S12)	This prevents automatic charging of the stored energy mechanism by motorized operating mechanism		S25

Special packaging for increased transport requirements (moisture protection)

Cardboard packaging with water-repellent coating on corrugated cardboard (moisture protection)	A61
--	-----

Shutters

Shutter: 2-part, lockable, with padlocks ³⁾ 3-pole/4-pole	Sizes 1, 2, 3	R21
--	---------------	-----

Interlocking

Mechanical interlocking mechanism

- Interlocking module with Bowden cable 2 m

Mechanical interlock	For fixed-mounted breakers	S55
	For withdrawable circuit breakers with guide frame	R55
	For guide frames (ordered separately)	R56
	For withdrawable circuit breakers (ordered separately)	R57

Locking provisions (for fixed-mounted and withdrawable circuit breakers)

- The disconnecter unit fulfills the requirements for main circuit breakers according to EN 60204-1

Locking provisions	Against unauthorized closing from the operator panel	Made by CES	S01
		Made by IKON	S03
		Assembly kit FORTRESS or CASTELL ⁴⁾	S05
		Assembly kit for padlocks ³⁾	S07
		Made by RONIS	S08
		Made by PROFALUX	S09

Locking provisions (for fixed-mounted and withdrawable versions)

Locking provisions	For charging handle with padlock ³⁾	S33
--------------------	--	-----

Locking provisions (for withdrawable circuit breaker)

- The disconnecter unit fulfills the requirements for main circuit breakers acc. to EN 60204-1, consisting of a lock in the guide frame, active in the connected position, function is retained when circuit breaker is replaced.
- Not possible in combination with order code "R81", "R85" or "R86".

Locking provisions	Against unauthorized closing from the operator panel	Made by CES	R61
		Made by RONIS	R68
		Made by PROFALUX	R60

¹⁾ Not possible with "communication port" option, order code "F02", "F12" or "F35".

²⁾ Only for breakers with motorized operating mechanism, not possible with order codes "C11", "C12".

³⁾ Padlock not included in the scope of supply.

⁴⁾ Locks must be ordered from the manufacturer.

To specify the options, add "-Z" to the complete article number and indicate the appropriate order code(s).

3WL.....-.....-..... -Z

Order code

Interlocking

Locking provisions (for withdrawable circuit breaker)

- Safety lock for mounting onto the circuit breaker

Locking provisions	To prevent movement of the withdrawable circuit breaker	Made by CES	S71
		Made by PROFALUX	S75
		Made by RONIS	S76

Locking mechanisms

- Not possible in combination with order code "R81", "R85" or "R86".
- R30 and R50 only possible on complete order for a circuit breaker with a guide frame or when ordering the guide frame separately

For fixed-mounted circuit breakers	To prevent opening of the cabinet door in ON position	S30
For withdrawable circuit breakers	To prevent opening of the cabinet door in connected position	R30
	To prevent movement when the cabinet door is open	R50

Locking mechanisms to prevent movement of the withdrawable circuit breakers in disconnected position

- Consisting of Bowden cable and lock in the control cabinet door
- Not possible in combination with order code "R30", "R50", "R61", "R68" or "R60".

Made by CES	R81
Made by PROFALUX	R85
Made by RONIS	R86

Seals

Door sealing frame for degree of protection IP41	T40
--	-----

Accessory options

Further technical specifications

Manual operating mechanism

3WL5

Switching on/charging energy store	
Maximum force required to operate the hand lever	≤230 N
Required number of strokes on the hand lever	9

Closing coils

3WL5

Primary operating range	
Version	For continuous command (100 % OP) 5 % OP
Primary operating range	0.85 ... 1.1 × U_s
Extended operating range for battery operation	0.85 ... 1.26 × U_s
24 ... 30 V DC, 48 ... 60 V DC 110 ... 125 V DC 220 ... 250 V DC	0.85 ... 1.26 × U_s
0.85 ... 1.1 × U_s	0.85 ... 1.1 × U_s
0.85 ... 1.26 × U_s	0.85 ... 1.26 × U_s
Rated voltage	
Rated control supply voltage U_s	50/60 Hz AC 110 ... 127 V, 208 ... 240 V DC 24 V, 30 V, 48 V, 60 V, 110 ... 125 V, 220 ... 250 V
Operation	
Closing power	40 W/40 VA ≤ 60 V: 200 W ≥ 110 V: 250 W
Continuous power	8 W/8 VA –
Minimum command duration at 100% U_s	60 ms 60 ms
Maximum command duration at 100% U_s	– 2000 ms
Make time of the circuit breaker at 100% U_s	100 ms 50 ms
Fuse protection of the control circuit at U_s for closing coil	
Smallest permissible DIAZED fuse, gL, slow-response	24 ... 30 V DC 2 A 10 A 48 ... 60 V DC 2 A 10 A 110 ... 125 V DC/110 ... 127 V AC 1 A 4 A 220 ... 250 V DC/208 ... 240 V AC 1 A 2 A
Miniature circuit breaker with C characteristic	24 ... 30 V DC 2 A 10 A 48 ... 60 V DC 2 A 10 A 110 ... 125 V DC/110 ... 127 V AC 1 A 4 A 220 ... 250 V DC/208 ... 240 V AC 1 A 2 A
Fuse protection of the control circuit at U_s for motorized operating mechanism + closing coil	
Smallest permissible DIAZED fuse, gL, slow-response	24 ... 30 V DC 6 A 10 A 48 ... 60 V DC 6 A 10 A 110 ... 125 V DC/110 ... 127 V AC 2 A 4 A 220 ... 250 V DC/208 ... 240 V AC 2 A 2 A
Miniature circuit breaker with C characteristic	24 ... 30 V DC 6 A 10 A 48 ... 60 V DC 6 A 10 A 110 ... 125 V DC/110 ... 127 V AC 2 A 4 A 220 ... 250 V DC/208 ... 240 V AC 2 A 2 A

Motor

3WL5

Primary operating range	
Primary operating range	0.85 ... 1.1 × U_s
Extended operating range for battery operation	0.85 ... 1.26 × U_s
At 24 V DC, 48 V DC 60 V DC, 110 V DC 220 V DC	
Operation	
Power consumption of motor	AC/DC 135 VA/135 W
Time required to charge the spring energy store at 1 × U_s	≤10 s
Short-circuit protection	
Smallest permissible DIAZED fuse (operational class gL)/ automatic circuit breaker with C characteristic (for different rated control supply voltages)	At U_s = 24 ... 30 V 6 A At U_s = 48 ... 60 V 6 A At U_s = 110 ... 125 V DC/ 110 ... 127 V AC 2 A At U_s = 220 ... 250 V DC/ 208 ... 240 V AC 2 A

Signals of the electronic trip unit

3WL5

Signals of the electronic trip unit

Measuring accuracy of the electronic trip unit

Protective functions acc. to EN 60947; current indication $\leq 10\%$; measurement function for base quantities $\leq 1\%$; measurement function for derived quantities $\leq 4\%$

Undervoltage releases UVR (F3) and UVR (F4)

3WL5

Primary operating range

Response values

Pickup

 $\geq 0.85 \times U_s$ (circuit breaker can be closed)

Dropout

 $0.35 \dots 0.7 \times U_s$ (circuit breaker is tripped)

Primary operating range

 $0.85 \dots 1.1 \times U_s$

Extended operating range for battery operation

At 24 V DC, 30 V DC,
48 V DC, 110 V DC,
220 V DC $0.85 \dots 1.26 \times U_s$

Rated voltage

Rated control supply voltage U_s

Instantaneous 50/60 Hz AC

110 ... 127 V, 208 ... 240 V, 380 ... 415 V

Instantaneous DC

24 V, 30 V, 48 V, 60 V, 110 ... 125 V, 220 ... 250 V

Delayed 50/60 Hz AC

110 ... 127 V, 208 ... 240 V, 380 ... 415 V

Delayed DC

48 V, 110 ... 125 V, 220 ... 250 V

Operation

Power consumption (pickup/uninterrupted duty)

AC

20/5 VA

DC

20/5 W

Opening time of the circuit breaker

Version UVR (F3)

Instantaneous

 ≤ 80 ms

With delay

200 ms

Version UVR- t_d (F8)With delay, $t_d = 0.2 \dots 3.2$ s

0.2 ... 3.2 s

Reset through additional NC
contact – direct tripping ≤ 100 ms

Short-circuit protection

Smallest permissible DIAZED fuse (operational class gL)/
miniature circuit breaker with C characteristic

1 A TDz (slow)/1 A

1

Accessory options

Further technical specifications

Shunt trip (ST) (F1, F2)

3WL5

Primary operating range		3WL5		
Version		For continuous command (100% OP), locks out on momentary -contact commands	5% OP	With spring energy store consisting of shunt trip and capacitor trip device
Primary operating range		$0.85 \dots 1.1 \times U_s$	$0.85 \dots 1.1 \times U_s$	$0.85 \dots 1.1 \times U_s$
Extended operating range for battery operation		$0.85 \dots 1.26 \times U_s$	$0.85 \dots 1.26 \times U_s$	–
Response values	Pickup	$>0.7 \times U_s$ (circuit breaker is tripped)	$>0.7 \times U_s$ (circuit breaker is tripped)	–
Rated operational voltage		3WL5		
Rated control supply voltage U_s	50/60 Hz AC	110 ... 127 V, 208 ... 240 V		230 V
	DC	24 ... 30 V, 48 ... 60 V, 110 ... 125 V, 220 ... 250 V		220 V
Operation		3WL5		
Closing power DC	AC/DC	40 W/40 VA	≤ 60 V: 200 W ≥ 110 V: 250 W	1 VA/1 W
Continuous power	AC/DC	8 W/8 VA	–	–
Minimum command duration at 100% U_s		60 ms	60 ms	–
Maximum command duration at 100% U_s		–	2000 ms	–
Opening time of the circuit breaker at 100% U_s		80 ms	50 ms	80 ms
Storage time at U_s /Recharging time at U_s		–	–	max. 5 min/min. 5 s
Fuse protection of the control circuit at U_s for shunt trip		3WL5		
Smallest permissible DIAZED fuse, gL, slow-response	24 ... 30 V DC	2 A	10 A	–
	48 ... 60 V DC	2 A	10 A	–
	110 ... 125 V DC/110 ... 127 V AC	1 A	4 A	–
	220 ... 250 V DC/208 ... 240 V AC	1 A	2 A	–
Miniature circuit breaker with C characteristic	24 ... 30 V DC	2 A	10 A	–
	48 ... 60 V DC	2 A	10 A	–
	110 ... 125 V DC/110 ... 127 V AC	1 A	4 A	–
	220 ... 250 V DC/208 ... 240 V AC	1 A	2 A	–

Remote reset magnet for mechanical tripped indicator (F7)

3WL5

Primary operating range		3WL5		
Primary operating range		$0.85 \dots 1.1 \times U_s$		
Extended operating range for battery operation	At 24 ... 30 V DC, 48 ... 60 V DC 110 ... 125 V DC, 220 ... 250 V DC	$0.7 \dots 1.26 \times U_s$		
Operation		3WL5		
Power consumption	AC/DC	60 VA/60 W		
Min. command duration at U_s for the remote reset magnet		60 ms		
Short-circuit protection		3WL5		
Smallest permissible DIAZED fuse (operational class gL)/ automatic circuit breaker with C characteristic		2 A TDz (slow)/2 A at $U_s = 24 \dots 60$ V DC, 1 A TDz (slow)/1 A at > 100 V DC and 100 V AC		

Contact position-driven auxiliary switches (S1, S2, S3, S4, S7, S8)

3WL5

Rated voltage		3WL5			
Rated insulation voltage U_i	AC/DC	500 V			
Rated operational voltage U_e	AC/DC	500 V			
Rated impulse withstand voltage U_{imp}		4 kV			
Contact reliability		From 1 mA at 5 V DC			
Breaking capacity		3WL5			
Alternating current 50/60 Hz	Rated operational voltage U_e	24 ... 230 V	380 V, 400 V		
	Rated operational current I_e /AC-12	10 A	10 A		
	Rated operational current I_e /AC-15	4 A	3 A		
Direct current	Rated operational voltage U_e	24 V	48 V	110 V	220 V
	Rated operational current I_e /DC-12	10 A	8 A	3.5 A	1 A
	Rated operational current I_e /DC-13	8 A	4 A	1.2 A	0.4 A
Short-circuit protection		3WL5			
Largest permissible DIAZED fuse (operational class gL)		10 A TDz, 10 A Dz			
Largest permissible miniature circuit breaker with C characteristic		10 A			

Ready-to-close signaling switches (S20) (acc. to DIN VDE 0630)

3WL5

Breaking capacity			
Alternating current 50/60 Hz	Rated operational voltage U_e	250 V	
	Rated operational current I_e	8 A	
Direct current	Rated operational voltage U_e	125 V	250 V
	Rated operational current I_e	0.4 A	0.2 A
	Contact reliability	From 1 mA at 5 V DC	

Short-circuit protection

Largest permissible DIAZED fuse (operational class gL) 2 A Dz (quick)

Tripped signaling switches (S24) and signaling switches for auxiliary releases (S22, S23) (acc. to DIN VDE 0630)

3WL5

Breaking capacity			
Alternating current 50/60 Hz	Rated operational voltage U_e	250 V	
	Rated operational current I_e /AC-12	8 A	
Direct current	Rated operational voltage U_e	24 V	125 V 250 V
	Rated operational current I_e /DC-12	6 A	0.4 A 0.2 A
	Contact reliability	From 1 mA at 5 V DC	

Short-circuit protection

Largest permissible DIAZED fuse (operational class gL) 6 A Dz (quick)

Tripped signaling switches

Signal duration after tripping Until manual or electrical remote reset (option)

Position signaling switches on guide frame

3WL5

Type of contacts			
Message	"Circuit breaker in connected position"	3 CO	or 1 CO
	"Circuit breaker in test position"	2 CO	or 1 CO
	"Circuit breaker in disconnected position"	1 CO	or 1 CO
Contact reliability	From 1 mA at 5 V DC		
Rated operational voltage			
Rated insulation voltage U_i	50/60 Hz AC	440 V	
	DC	250 V	
Rated operational voltage U_e	250 V		
Rated impulse withstand voltage U_{imp}	4 kV		
Breaking capacity			
Rated operational current I_e	I_e /AC-12	24 V 10 A, 110/127 V 10 A, 220/240 V 10 A, 320/440 V 10 A	
	I_e /AC-15	220/240 V 4 A, 320/440 V 3 A	
	I_e /DC-12	24 V 10 A, 48 V 2.5 A, 220/240 V 0.2 A	
	I_e /DC-13	24 V 3.0 A, 220/240 V 0.1 A	
	A 300 (AC)	120 V 6 A, 240 V 3 A	
	R 300 (DC)	125 V 0.22 A, 250 V 0.11 A	
Short-circuit protection			
Largest permissible DIAZED fuse (operational class gL)	8 A TDz (slow)		
Largest permissible automatic circuit breaker with C characteristic	8 A TDz (slow)		

Guide frames for AC

The structure shown below is intended as an overview of each position and its meaning. For a complete and valid configuration of your guide frame, please use our online configurator at www.siemens.com/lowvoltage/3wl-configurator

		5	6	7	8	9	10	11	12	13	14	15	16
3WL9		2	5		-					-		A	1
Size (SZ)	1			1									
	2			2									
	3			3									
		SZ 1	SZ 2	SZ 3									
Max. rated current I_n	1000 A	■	-	-	1								
	1600 A	■	-	-	2								
	2000 A	-	■	-	3								
	2500 A	-	■	-	4								
	3000 A	-	■	-	5								
	4000 A	-	-	■	6								
	5000 A	-	-	■	7								
Number of poles	3-pole	■	■	■								A	
	4-pole	■	■	■								B	
Main connection	Front, single hole	■	■	■ ¹⁾								A	
	Front, double hole	■	■	■ ¹⁾								B	
	Horizontal	■	■	■								C	
	Vertical	■	■	■								D	
	Connecting flange	■	■	■ ¹⁾								E	

¹⁾ Not available for rated circuit breaker current 5000 A

Options

		5	6	7	8	9	10	11	12	13	14	15	16
3WL9		2	5		-					-		A	1
Number of auxiliary supply connectors	Without							0					
	1 connector							1					
	2 connectors							2					
	3 connectors							3					
	4 connectors							4					
Type of auxiliary circuit connections	Without ²⁾								0				
	With screw terminals (SIGUT, standard)								1				
	With screwless terminals (tension spring)								2				
Position signaling switches	Without									0			
	1 CO 1 CO 1 CO (connected test isolated position)									1			
	3 CO 2 CO 1 CO (connected test isolated position)									2			
Shutters	Without										A		
	With shutter, 2-part, lockable										B		

²⁾ Can only be selected if the number of auxiliary supply connectors = without

Accessories and spare parts

Accessories for electronic trip units ETU

Electronic trip units ETU45B with device holder and optional measurement function



- For replacement in existing circuit breakers, please specify the circuit breaker ID No. when ordering.

Type	With protective function	Measurement function	Article No.
ETU45B (without display)	LSIN(G)	Without	3WL9354-5AA00-0AA1
		With measurement function Plus	3WL9354-5AA20-0AA1

Rating plugs

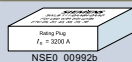

- With the rating plug selected, the maximum rated current $I_{n \max}$ of the circuit breaker must not be exceeded. The following applies: $I_n \leq I_{n \max}$.

Size	Rated current I_n	Article No.
1, 2	250 A	3WL9111-2AA51-0AA0
	315 A	3WL9111-2AA52-0AA0
	400 A	3WL9111-2AA53-0AA0
	500 A	3WL9111-2AA54-0AA0
	630 A	3WL9111-2AA55-0AA0
	800 A	3WL9111-2AA56-0AA0
1, 2, 3	1000 A	3WL9111-2AA57-0AA0
	1250 A	3WL9111-2AA58-0AA0
2, 3	1600 A	3WL9111-2AA61-0AA0
	2000 A	3WL9111-2AA62-0AA0
3	2500 A	3WL9111-2AA63-0AA0
	3000 A	3WL9111-2AA77-0AA0
	3200 A	3WL9111-2AA64-0AA0
3	4000 A	3WL9111-2AA65-0AA0
	5000 A	3WL9111-2AA66-0AA0

Ground-fault modules



- Alarm and tripping
- For direct metering of the ground-fault current, e.g. in the star point of the transformer, a 1200 A/1 A current transformer, class 1, is required. The internal load of the 3WL circuit breaker is 0.11 Ω . If the ground-fault current is to be determined using the vectorial sum of the phases, a transformer must be installed in the neutral conductor.

Type	Accessory for	Article No.
GFM AT 45B	ETU45B	3WL9111-2AT53-0AA0

Display



For ETU	Version	Article No.
ETU45B	4-line	3WL9111-1AT81-0AA0

External current transformers for N conductor



Version	Size	Article No.
For mounting on busbar	1	3WL9111-0AA21-0AA0
	2	3WL9111-0AA22-0AA0
	3	3WL9111-0AA23-0AA0



For busbar connection	1	3WL9111-0AA31-0AA0
	2	3WL9111-0AA32-0AA0
	3	3WL9111-0AA33-0AA0

EMC filter

- Common-mode interference suppressor filters (e.g. in IT networks, caused by frequency converters)
- Insertion loss (asymmetric) in the range 40 kHz to 10 MHz >40 dB.

Types	Article No.
Only for ETU release 2	3WL9111-0AK32-0AA0

Accessories and spare parts

Accessories for electronic trip units ETU

Sealable and lockable covers



Accessory for	Article No.
ETU45B	3WL9111-0AT45-0AA0

Automatic reset of the reclosing lockout

Version	Article No.
Spare part for option K01	3WL9111-0AK21-0AA0

Remote reset magnets

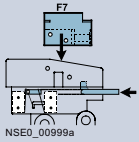

Use	Article No.
<ul style="list-style-type: none"> For mechanical tripped indicator Spare part for options K10 to K13 Note: Automatic reset of the reclosing lockout 3WL9111-0AK21-0AA0 is also required 	
Voltage	Article No.
24 ... 30 V DC	3WA9111-0EM42
48 ... 60 V DC	3WA9111-0EM44
120 V AC/125 V DC	3WA9111-0EM45
208 ... 250 V AC/208 ... 250 V DC	3WA9111-0EM46

Retrofittable internal wiring

Use	Male connector	Accessory for	Article No.
Internal wiring of CubicleBUS for connection to terminal X8	Without male connector for retrofitting the communication	ETU45B	3WL9111-0AK30-0AA0
For connection of the external N and G transformers to terminal X8	With male connector	Not for ETU Release 2	3WL9111-0AK31-0AA0

Locking provisions and interlocks

Interlocking sets for mechanical Open/Close

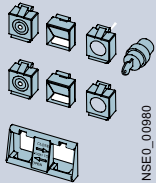

Use	Article No.
<ul style="list-style-type: none"> Consisting of two transparent covers each for sealing or for attaching padlocks (padlocks not included in scope of supply) Cover with 6.35 mm hole (for tool actuation) Lock mount for safety lock for key operation 	
Version	Article No.
Without safety lock	3WL9111-0BA21-0AA0
Made by CES	3WL9111-0BA22-0AA0
Made by IKON	3WL9111-0BA24-0AA0

Locking provision against unauthorized closing from the operator panel

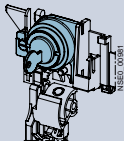

Type	Scope of supply	Article No.
Assembly kit FORTRESS or CASTELL	Without locks, cylinders or keys	3WL9111-0BA31-0AA0
Made by RONIS	Locks, cylinders and keys included	3WL9111-0BA33-0AA0
Made by KIRK-Key	Without locks, cylinders or keys	3WL9111-0BA34-0AA0
Made by PROFALUX	Locks, cylinders and keys included	3WL9111-0BA35-0AA0
Made by CES	Locks, cylinders and keys included	3WL9111-0BA36-0AA0
Made by IKON	Locks, cylinders and keys included	3WL9111-0BA38-0AA0
Assembly kit for padlocks	Without padlock	3WL9111-0BA41-0AA0

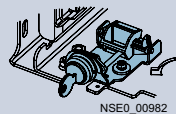

Locking provision against unauthorized closing, for withdrawable circuit breakers



Type	Scope of supply	Article No.
<ul style="list-style-type: none"> The disconnecter unit fulfills the requirements for main circuit breakers acc. to EN 60204-1 Consisting of lock in the cabinet door, active in connected position, function is retained when circuit breaker is replaced Spare part for option R60, R61, R68 		
Made by CES	Locks, cylinders and keys included	3WL9111-0BA51-0AA0
Made by IKON	Locks, cylinders and keys included	3WL9111-0BA53-0AA0
Made by KIRK-Key 1)	Without locks, cylinders or keys	3WL9111-0BA57-0AA0
Made by RONIS	Locks, cylinders and keys included	3WL9111-0BA58-0AA0
Made by PROFALUX	Locks, cylinders and keys included	3WL9111-0BA50-0AA0

¹⁾ Locks, cylinders and keys must be ordered from the manufacturer.

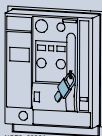
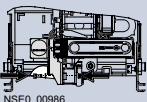
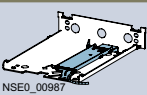
Locking provisions and interlocks

Locking provisions for charging handle with padlock		
	Version	Article No.
	Spare part for option S33	3WL9111-0BA71-0AA0
Locking provision to prevent movement of the withdrawable circuit breaker		
	<ul style="list-style-type: none"> Safety lock for mounting onto the circuit breaker Spare part for option S71, S75, S76 	
	Type	Article No.
	Made by CES	3WL9111-0BA73-0AA0
	Made by IKON	3WL9111-0BA75-0AA0
	Made by PROFALUX	3WL9111-0BA76-0AA0
	Made by RONIS	3WL9111-0BA77-0AA0
Made by KIRK-Key ¹⁾	3WL9111-0BA80-0AA0	
Interlocking systems		
	<ul style="list-style-type: none"> 2 of the same keys for 3 circuit breakers Locking provision in OFF position Lock in the operator panel A maximum of 2 circuit breakers can be switched on 	
	Type	Article No.
	Made by CES	3WL9111-0BA43-0AA0
Locking mechanisms to prevent movement of the withdrawable circuit breakers in disconnected position		
	<ul style="list-style-type: none"> Consisting of Bowden cable and lock in the cabinet door on the circuit breaker Spare part for option R81, R85, R86 Note: Not possible in combination with "Locking mechanism to prevent opening of the cabinet door" (order code "R30") or "Locking mechanism to prevent movement with the cabinet door open" (order code "R50"). 	
	Type	Article No.
	Made by CES	3WL9111-0BA81-0AA0
	Made by IKON	3WL9111-0BA83-0AA0
	Made by PROFALUX	3WL9111-0BA85-0AA0
	Made by RONIS	3WL9111-0BA86-0AA0
Locking mechanisms to prevent opening of the cabinet door in ON position		
	<ul style="list-style-type: none"> Fixed-mounted Defeatable Note: Not possible in combination with "Locking mechanism to prevent movement of the withdrawable circuit breakers in disconnected position" (order codes "R81", "R85" or "R86"). 	
	Version	Article No.
	Spare part for option S30	3WL9111-0BB12-0AA0
Locking mechanisms to prevent opening of the cabinet door		
	<ul style="list-style-type: none"> Guide frames Defeatable Note: Not possible in combination with "Locking mechanism to prevent movement of the withdrawable circuit breakers in disconnected position" (order codes "R81", "R85" or "R86"). 	
	Version	Article No.
	Spare part for option R30	3WL9111-0BB13-0AA0
Locking mechanisms to prevent movement with the cabinet door open		
	<ul style="list-style-type: none"> Guide frames Note: Not possible in combination with "Locking mechanism to prevent movement of the withdrawable circuit breakers in disconnected position" (order codes "R81", "R85" or "R86"). 	
	Version	Article No.
	Spare part for option R50	3WL9111-0BB15-0AA0

¹⁾ Locks, cylinders and keys must be ordered from the manufacturer

Accessories and spare parts

Locking provisions and interlocks

Mechanical interlocks

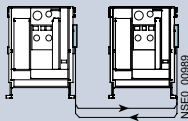

- With Bowden cable 2000 mm (one required for each circuit breaker)

Type	When ordered separately	Spare part for	Article No.
Fixed-mounted circuit breaker	–	Option S55	3WL9111-0BB21-0AA0
Module for withdrawable circuit breakers with guide frame	–	Option R55	3WL9111-0BB24-0AA0
Module for guide frame	✓	Option R56	3WL9111-0BB22-0AA0
Module for withdrawable circuit breaker	✓	Option R57	3WL9111-0BB23-0AA0
Adapter for size 3 withdrawable circuit breaker	✓	–	3WL9111-0BB30-0AA0

Couplings on the circuit breaker (with ring) for mutual interlocking



- Can be used in all circuit breakers

Article No.
3WL9112-8AH47-0AA0

Bowden cables

Length	Article No.
2000 mm	3WL9111-0BB45-0AA0
3000 mm	3WL9111-0BB46-0AA0
4500 mm	3WL9111-0BB47-0AA0

Test devices

Manual tester, Release 2 for electronic trip units ETU25B to ETU45B



- For testing the Electronic Trip Unit functions of all 3WL ETUs (Release 1 and Release 2)

Article No.
3WL9111-0AT32-0AA0

Function test unit

- For testing the tripping characteristics for electronic trip units ETU15B to ETU76B (Release 1 and Release 2)

Article No.
3WL9111-0AT44-0AA0

TD400 Kit IEC¹⁾

- Commissioning/Service Tool for UL 3WL5 (ETU release 1)
- With adapter, cable and case

Article No.
3VW9011-0AT41

TD400 adapter (spare part)

Version	Article No.
for 3VA	3VW9011-0AT43
for 3WL ETU release 1	3VW9011-0AT44

Storage devices

Capacitor trip device

- For shunt trips
- Storage time 5 min
- Also suitable for 3VL circuit breakers
- **Note:** Rated control supply voltage must match the rated control supply voltage of the shunt trips.

Rated control supply voltage/rated operational voltage	Article No.
50/60 Hz AC	DC
220 ... 240 V	220 ... 250 V
	3WL9111-0BA14-0AA0

¹⁾ A country-specific radio license is required to operate the Bluetooth interface. Before activating the Bluetooth function, ensure that the license is available: www.siemens.com/lowvoltage/certificates

Indicators and control elements

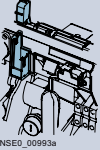
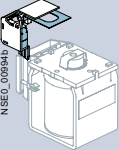
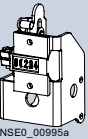
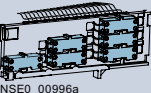
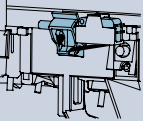
Ready-to-close signaling switches (S20)			
 NSE0_00993a	Version	Contacts	Article No.
	Spare part for option C22	1 NO	3WL9111-0AH01-0AA0
Signaling switch (S22 or S23)			
 NSE0_00994a	<ul style="list-style-type: none"> Not possible with communication port, order code "F02", "F12" or "F35" Auxiliary supply connector X7 required for circuit breakers or guide frames. If this is not already available, please order additionally 		
	Version	Contacts	Article No.
Spare part for options C26 to C27	1st or 2nd auxiliary release	3WL9111-0AH02-0AA0	
1st tripped signaling switch (S24)			
	<ul style="list-style-type: none"> Not possible with communication port, order code "F02", "F12" or "F35" Auxiliary supply connector X7 required for circuit breakers or guide frames. If this is not already available, please order additionally 		
	Version	Contacts	Article No.
Spare part for option K07	1 CO	3WL9111-0AH14-0AA0	
2nd tripped signaling switch (S25)			
	<ul style="list-style-type: none"> Not possible with communication port, order code "F02", "F12" or "F35" Auxiliary supply connector X7 required for circuit breakers or guide frames. If this is not already available, please order additionally Can only be used in combination with 1st tripped signaling switch 		
	Version	Contacts	Article No.
Spare part for option K06	1 NO	3WL9111-0AH17-0AA0	
Operating cycle counters			
 NSE0_00995a	<ul style="list-style-type: none"> Only in conjunction with motorized operating mechanism 		
	Type	Version	Article No.
Spare part for option C01	Mechanical	3WL9111-0AH07-0AA0	
Spring charge signaling switch			
	<ul style="list-style-type: none"> Not possible with communication port, order code "F02", "F12" or "F35". Auxiliary supply connector X7 required for circuit breakers or guide frames. If this is not already available, please order additionally 		
	Version	Contacts	Article No.
Spare part for option C20	1 NO	3WL9111-0AH08-0AA0	
Position signaling switches for guide frames			
 NSE0_00996a	Version	Contacts	Article No.
	Spare part for options R15 to R16	1st block (3 CO) 2nd block (6 CO)	3WL9111-0AH11-0AA0 3WL9111-0AH12-0AA0
Local electric close (S10) for operator panel			
 NSE0_00997a	<ul style="list-style-type: none"> Not possible with communication port, order code "F02", "F12" or "F35" Not possible with motor shutdown switch Button + wiring (Auxiliary supply connector X7 required for circuit breakers or guide frames. If this is not already available, please order additionally) Note: Possible only for circuit breakers with closing coil. 		
	Version	Type	Article No.
Spare part for options C11 to C12	With sealing cap C11	3WL9111-0AJ02-0AA0	
	With CES assembly kit C12	3WL9111-0AJ03-0AA0	
	With IKON assembly kit	3WL9111-0AJ05-0AA0	
Motor shutdown switch (S12)			
	<ul style="list-style-type: none"> Mounting onto operator panel Not possible with local electric close 		
	Version	Article No.	
Spare part for option S25	3WL9111-0AJ06-0AA0		

Accessories and spare parts

Indicators and control elements

EMERGENCY-OFF pushbuttons

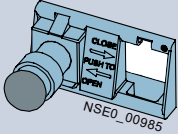

- Mushroom pushbutton instead of the mechanical OFF pushbutton

Type	Article No.
Spare part for option S24	3WL9111-0BA72-0AA0

Auxiliary conductor connections

Male connectors for circuit breakers ①

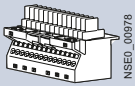

Article No.
3WA9111-0AB01

Extension for male connector

- Male connector must be ordered separately

Version	Article No.
1000 V	3WA9111-0AB02

Auxiliary supply connection for circuit breakers or guide frames ②

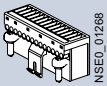

Version	Article No.
Screw connection (SIGUT)	3WA9111-0AB03

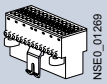

Screwless connection (tension spring)	3WL9111-0AB04-0AA0
---------------------------------------	--------------------

Coding kits ③



Version	Article No.
For fixed-mounted X5 to X8	3WA9111-0AB07

Sliding contact modules for guide frames ④

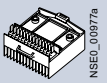

Article No.
3WA9111-0AB08

One-part sliding contact modules for guide frames ⑤

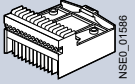

Version	Article No.
Screw connection (SIGUT)	3WL9111-0AB18-0AA0

Blanking blocks for circuit breakers

Article No.
3WA9111-0AB12

For a complete auxiliary current connection you must order:

Fixed-mounted version: ① + ② + ③

Withdrawable version: ① + ④ + ② or ① + ⑤

Auxiliary releases

Closing coils/shunt trips

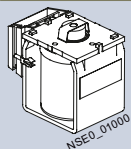

Version	Voltage	Article No.
100% OP	24 ... 30 V DC	3WA9111-0AD02
	48 ... 60 V DC	3WA9111-0AD04
	110 ... 125 V DC/110 ... 127 V AC	3WA9111-0AD05
	220 ... 250 V DC/208 ... 240 V AC	3WA9111-0AD06

Closing coil (CC)

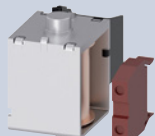

- For momentary duty, with cut-off switch S15

Version	Voltage	Article No.
5 % OP Switching time 50 ms	24 ... 30 V DC	3WA9111-0AD12
	48 ... 60 V DC	3WA9111-0AD14
	110 ... 125 V DC/110 ... 127 V AC	3WA9111-0AD15
	220 ... 250 V DC/208 ... 240 V AC	3WA9111-0AD16

Shunt trip (ST)

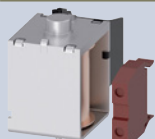

- For momentary duty, with cut-off switch S14

Version	Voltage	Article No.
5 % OP Switching time 50 ms	24 ... 30 V DC	3WA9111-0AD22
	48 ... 60 V DC	3WA9111-0AD24
	110 ... 125 V DC/110 ... 127 V AC	3WA9111-0AD25
	220 ... 250 V DC/208 ... 240 V AC	3WA9111-0AD26

Undervoltage release



Version	Voltage	Article No.
Instantaneous	24 V DC	3WA9111-0AE02
	30 V DC	3WL9111-0AE02-0AA0
	48 V DC	3WA9111-0AE04
	60 V DC	3WL9111-0AE07-0AA0
	110 ... 125 V DC/110 ... 127 V AC	3WA9111-0AE05
	220 ... 250 V DC/208 ... 240 V AC	3WA9111-0AE06



Delayed	48 V DC	3WA9111-0AE13
	110 ... 125 V DC/110 ... 127 V AC	3WA9111-0AE15
	220 ... 250 V DC/208 ... 240 V AC	3WA9111-0AE16

Operating mechanism

Motorized operating mechanisms

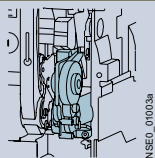

- Auxiliary supply connector X5 required for circuit breakers or guide frames.
If this is not already available, please order additionally

Voltage	Article No.
24 ... 30 V DC	3WA9111-0AF02
48 ... 60 V DC	3WA9111-0AF04
110 ... 125 V DC/110 ... 127 V AC	3WA9111-0AF05
220 ... 250 V DC/208 ... 240 V AC	3WA9111-0AF06

Auxiliary contacts

Auxiliary switch blocks

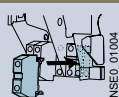

Contacts	Article No.
2 NO + 2 NC	3WL9111-0AG01-0AA0
2 NO	3WL9111-0AG02-0AA0
1 NO + 1 NC	3WL9111-0AG03-0AA0

Accessories and spare parts

Door sealing frames, hoods, shutters

Door sealing frames



Version	Article No.
Spare part for option T40	3WL9111-0AP01-0AA0

Protective covers IP55



- Cannot be used in conjunction with door sealing frames
- Hood removable and can be opened on both sides

Article No.
3WL9111-0AP03-0AA0

Shutters

Version	Number of poles	Size	Breaking capacity	Article No.
Spare part for option R21	3-pole	1	N, S, H	3WL9111-0AP04-0AA0
		2	N, S, H	3WL9111-0AP06-0AA0
		3	H, C	3WL9111-0AP07-0AA0
	4-pole	1	N, S, H	3WL9111-0AP08-0AA0
		2	N, S, H	3WL9111-0AP11-0AA0
		3	H, C	3WL9111-0AP12-0AA0

Coding for withdrawable version

Coding for withdrawable version

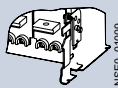

- By customer, for 36 coding variants

Size	Article No.
1 and 2	3WL9111-0AR12-0AA0
3	3WL9111-0AR13-0AA0

Support brackets

Support brackets



- For mounting fixed-mounted circuit breakers on vertical plane
- Only for sizes 1 and 2 (1 set = 2 units)

Article No.
3WL9111-0BB50-0AA0

CubicleBUS modules

- Each CubicleBUS module is supplied with a 0.2 m pre-assembled cable to connect the modules with each other. A longer pre-assembled cable is required for connection to the circuit breaker.
- All communication components, **CubicleBUS** modules and measurement functions are available for the electronic trip units ETU45B.

Modules of the CubicleBUS



Type	Article No.
Digital output module with rotary coding switch, relay outputs	3WL9111-1AT26-0AA0
Digital output module, configurable, relay outputs	3WL9111-1AT20-0AA0
Digital input module	3WL9111-1AT27-0AA0
Analog output module	3WL9111-1AT23-0AA0
ZSI module	3WL9111-1AT21-0AA0

Preassembled cables for CubicleBUS modules

For connection to 3WL	Length	Article No.
With COM15/COM16/COM35	0.2 m	3WL9111-0BC04-0AA0
	1 m	3WL9111-0BC02-0AA0
	2 m	3WL9111-0BC03-0AA0
Without COM15/COM16/COM35	2 m	3WL9111-0BC05-0AA0

Retrofitting and spare parts

- All communication components, **CubicleBUS** modules and measurement functions are available for the electronic trip units ETU45B.

COM35 PROFINET IO / Modbus TCP modules		
	Version	Article No.
	For electronic trip units ETU45B	3WL9111-1AT66-0AA0
COM15 PROFIBUS module		
	Version	Article No.
	For electronic trip units ETU45B	3WL9111-1AT65-0AA0
COM16 Modbus module		
	Version	Article No.
	For electronic trip units ETU45B	3WL9111-1AT15-0AA0
Breaker status sensor (BSS)		
	Version	Article No.
	For electronic trip units ETU45B	3WL9111-1AT16-0AA0
Measurement function Plus		
<ul style="list-style-type: none"> A measuring accuracy of 3% is achieved if retrofitted. 		
	Version	Article No.
	For electronic trip units ETU45B external voltage transformer required, e.g. GE Grid Solutions Model 468.	3WL9111-1AT03-0AA0

Main conductor connections, fixed-mounted versions (essential accessory)

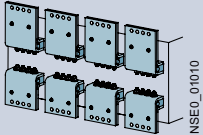
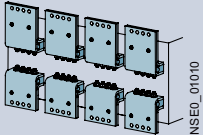
Front-accessible main connections, single hole at top				
	Size	Rated current I_n	Article No.	
	1	≤ 1000 A	3WL9111-0AL01-0AA0	
		1250 ... 1600 A	3WL9111-0AL02-0AA0	
	2	≤ 2000 A	3WL9111-0AL03-0AA0	
		≤ 2500 A	3WL9111-0AL04-0AA0	
		≤ 3200 A	3WL9111-0AL05-0AA0	
		≤ 4000 A	3WL9111-0AL06-0AA0	
	3	≤ 4000 A		
	Front-accessible main connections, single hole at bottom			
		Size	Rated current I_n	Article No.
		1	≤ 1000 A	3WL9111-0AL51-0AA0
			1250 ... 1600 A	3WL9111-0AL52-0AA0
2		≤ 2000 A	3WL9111-0AL53-0AA0	
		≤ 2500 A	3WL9111-0AL54-0AA0	
		≤ 3200 A	3WL9111-0AL55-0AA0	
		≤ 4000 A	3WL9111-0AL56-0AA0	
3		≤ 4000 A		
Front-accessible main connections according to DIN 43673, double hole at top				
		Size	Rated current I_n	Article No.
		1	≤ 1000 A	3WL9111-0AL07-0AA0
			1250 ... 1600 A	3WL9111-0AL08-0AA0
	2	≤ 2000 A	3WL9111-0AL11-0AA0	
		≤ 2500 A	3WL9111-0AL12-0AA0	
		≤ 3200 A	3WL9111-0AL13-0AA0	
		≤ 4000 A	3WL9111-0AL14-0AA0	
	3	≤ 4000 A		

Accessories and spare parts

Main conductor connections, fixed-mounted versions (essential accessory)

Front-accessible main connections according to DIN 43673, double hole at bottom

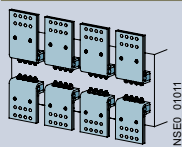

Size	Rated current I_n	Article No.
1	≤ 1000 A ¹⁾	3WL9111-0AL57-0AA0
	1250 ... 1600 A	3WL9111-0AL58-0AA0
2	≤ 2000 A	3WL9111-0AL61-0AA0
	≤ 2500 A	3WL9111-0AL62-0AA0
	≤ 3200 A	3WL9111-0AL63-0AA0
3	≤ 4000 A	3WL9111-0AL64-0AA0

Rear vertical main connections



Size	Rated current I_n	Article No.
1 ¹⁾	≤ 1600 A	3WL9111-0AM01-0AA0
2 ²⁾	≤ 3200 A	3WL9111-0AM02-0AA0
3	≤ 6300 A	3WL9111-0AM03-0AA0

¹⁾ In the case of vertical connection size 1 with breaking capacity N and S, up to 1000 A one 3WL9111-0AM01-0AA0 vertical connection is required up to 1600 A or with breaking capacity H two 3WL9111-0AM01-0AA0 vertical connections are required.

²⁾ In the case of vertical connection size 2, up to 2500 A one 3WL9111-0AM02-0AA0 vertical connection is required up to 3200 A two 3WL9111-0AM02-0AA0 vertical connections are required.

Main conductor connections, withdrawable versions (essential accessory)

Front-accessible main connections, single hole at top or at bottom ¹⁾

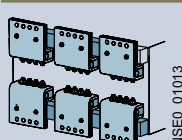

Size	Rated current I_n	Article No.
1	≤ 1000 A	3WL9111-0AN01-0AA0
	1250 ... 1600 A	3WL9111-0AN02-0AA0
2	≤ 2000 A	3WL9111-0AN03-0AA0
	≤ 2500 A	3WL9111-0AN04-0AA0
	≤ 3200 A	3WL9111-0AN05-0AA0
	≤ 4000 A	3WL9111-0AN06-0AA0

Front-accessible main connections according to DIN 43673, double hole at top or at bottom ¹⁾

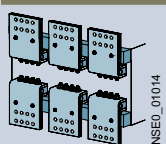

Size	Rated current I_n	Article No.
1	≤ 1000 A	3WL9111-0AN07-0AA0
	1250 ... 1600 A	3WL9111-0AN08-0AA0
2	≤ 2000 A	3WL9111-0AN11-0AA0
	≤ 2500 A	3WL9111-0AN12-0AA0
	≤ 3200 A	3WL9111-0AN13-0AA0
	≤ 4000 A	3WL9111-0AN14-0AA0

¹⁾ When using front-accessible main connections (withdrawable circuit breakers) supports are required

Main conductor connections, withdrawable versions (essential accessory)

Supports for front and DIN connecting bars

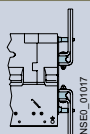

Number of poles	Size	Article No.
3-pole for 3 bars	1	3WL9111-0AN41-0AA0
	2	3WL9111-0AN42-0AA0
	3	3WL9111-0AN43-0AA0
4-pole for 4 bars	1	3WL9111-0AN44-0AA0
	2	3WL9111-0AN45-0AA0
	3	3WL9111-0AN46-0AA0

Rear vertical main connections



Size	Rated current I_n	Article No.
1	≤ 1000 A	3WL9111-0AN15-0AA0
	1250 ... 1600 A	3WL9111-0AN16-0AA0
2	≤ 2000 A	3WL9111-0AN17-0AA0
	≤ 2500 A	3WL9111-0AN18-0AA0
	≤ 3200 A	3WL9111-0AN21-0AA0
3	≤ 5000 A	3WL9111-0AN22-0AA0

Rear horizontal main connections

Size	Rated current I_n	Article No.
1	≤ 1000 A	3WL9111-0AN32-0AA0
	1250 ... 1600 A	3WL9111-0AN33-0AA0
1	≤ 2000 A	3WL9111-0AN34-0AA0
	≤ 2500 A	3WL9111-0AN35-0AA0
	≤ 3200 A	3WL9111-0AN36-0AA0
3	≤ 5000 A	3WL9111-0AN37-0AA0

Connecting flange

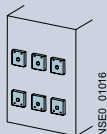

Size	Rated current I_n	Article No.
1	≤ 1000 A	3WL9111-0AN24-0AA0
	1250 ... 1600 A	3WL9111-0AN25-0AA0
2	≤ 2000 A	3WL9111-0AN26-0AA0
	≤ 2500 A	3WL9111-0AN27-0AA0
	≤ 3200 A	3WL9111-0AN28-0AA0
3	≤ 4000 A	3WL9111-0AN31-0AA0

Conversion kit

Conversion kit for converting fixed-mounted circuit breakers into withdrawable circuit breakers

- Only for AC circuit breakers/non-automatic air circuit breakers
- Guide frames and sliding contact modules must be ordered separately

Number of poles	Size	Article No.
3-pole	1	3WL9111-OBC11-0AA0
	2	3WL9111-OBC12-0AA0
	3	3WL9111-OBC13-0AA0
4-pole	1	3WL9111-OBC14-0AA0
	2	3WL9111-OBC15-0AA0
	3	3WL9111-OBC16-0AA0

One system. For all applications

Requirements for cost- and energy-efficient operation of electrical power distribution are on the increase. Whether in industrial plants, in infrastructure or in buildings: As a modular, highly adaptable system, the 3VA series of molded case circuit breakers ensures fully reliable protection of personnel and plant, and supports every process phase – from planning to operation of electrical power distribution.

Comprehensively certified. Deployable worldwide.

3VA molded case circuit breakers are available in various ranges with IEC approval; other ranges are available that comply with standard IEC 60947 and standard UL 489. The system is therefore ideally suited for mechanical engineering companies and switchgear manufacturers. The full range of functionalities of molded case circuit breakers can be used for plant and equipment operating in Europe and North America, with absolute standards compliance assured.



Molded Case Circuit Breakers

All the information you need	2/2
Molded case circuit breakers for all applications	2/4
Quick selection guide	2/6
Molded case circuit breakers and accessories	2/6
3VA5 molded case circuit breakers up to 2000 A	2/8
3VA6 molded case circuit breakers up to 2000 A	2/12
Trip units	2/16
Online configurator highlights	2/18
3VA51 – 3VA69 new	2/20
System overview	2/20
Structure of the article numbers	2/22
Internal accessories	2/26
Manual operators	2/28
Motor operators	2/40
Connection technology	2/42
Plug-in and withdrawable technology	2/70
Communication	2/73
Locking, blocking and interlocking	2/78
Cover frame and mounting	2/82
3VL	2/86
3VL up to 1600 A, according to UL 489	2/86

A multitude of additional information ...

Information + ordering

All the important things at a glance

For information about molded case circuit breakers, please visit our website www.siemens.com/3VA

Your product in detail

The Siemens Industry Online Support (SIOS) provides comprehensive information
www.siemens.com/lowvoltage/product-support

- Technical basic information
 - 3VA molded case circuit breakers (109766672)

The relevant tender specifications can be found at
www.siemens.com/lowvoltage/tenderspecifications

Use our conversion tool for quick and easy conversion to Siemens products
www.siemens.com/conversion-tool

Siemens YouTube channel

- 3VA molded case circuit breakers (general)
bit.ly/2xNxIFA

Everything you need for your order

Refer to the Industry Mall for an overview of your products

- 3VA molded case circuit breakers, UL/IEC
sie.ag/2yPsA2e

Direct forwarding to the individual products in the Industry Mall by clicking on the article number in the catalog or by entering this web address incl. article number
www.siemens.com/product?Article No.

Configurators

The configurator reduces the time and effort required in the planning and ordering process, and allows for individual adaptations. Configure your 3VA molded case circuit breaker at

www.siemens.com/lowvoltage/3va-ul-configurator

The following are additionally available for your 3VA molded case circuit breaker:

- 3D views
- CAD data
- Unit wiring diagrams
- Dimension drawings

The fast track to the experts

Contact persons in your region

We offer a comprehensive portfolio of services. You can find your local contacts at
www.siemens.com/lowvoltage/components/contact

You can find further information on services at
www.siemens.com/service-catalog

Competent expert advice on technical questions with a wide range of demand-optimized services for all our products and systems.

Assistance with technical queries is provided at
www.siemens.com/support-request

... can be found in our online services

Commissioning + operation

SENTRON powerconfig

The combined commissioning and service tool SENTRON powerconfig for communication-capable measuring devices, circuit protection devices and circuit breakers.

Free download SENTRON powerconfig via www.siemens.com/powerconfig

Free download SENTRON powerconfig mobile via [App Store](#) and [Play Store](#)

Your product in detail

The Siemens Industry Online Support (SIOS) provides detailed technical information www.siemens.com/lowvoltage/product-support

- Operating instructions
- Characteristic curves
- Certificates

Comprehensive mobile support via the Siemens Industry Online Support app available for download from the [App Store](#) and [Play Store](#)

You will find further information under: www.siemens.com/support-app

Provision of 3D data (step and u3d data formats)

- Siemens Industry Mall www.siemens.com/lowvoltage/mall
- Image database www.siemens.com/lowvoltage/picturedb

Engineering data for CAD or CAE systems are available in the CAX Download Manager at www.siemens.com/cax

Manuals

Manuals are available for downloading in Siemens Industry Online Support (SIOS) at www.siemens.com/lowvoltage/manuals

- Configuration manual
 - 3VA selectivity ([109743975](#))
- Communication manual
 - 3VA molded case circuit breakers with IEC and UL certification ([98746267](#))
- Equipment manual
 - 3VA molded case circuit breakers with UL and IEC certification ([109758561](#))

Face-to-face or online training

Our training courses can be found at www.siemens.com/sitrain-lowvoltage

- 3VA molded case circuit breakers (WT-LVA3VA)
- Protection systems in low-voltage power distribution (WT-LVAPS)
- Communication with SENTRON components (LV-COM)
- Project planning and selection of SENTRON circuit breakers (LV-CBPROJ)

Technical overview – Molded case circuit breakers



The fast way to get you to our online services

This page provides you with comprehensive information and links on molded case circuit breakers www.siemens.com/lowvoltage/product-support ([109767421](#))

Molded case circuit breakers for all applications

2

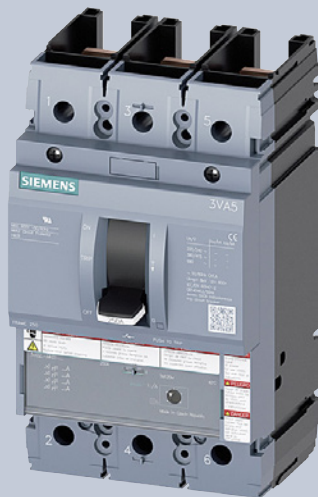

3VA51 ... 3VA59
molded case circuit breakers

Ideal for standard applications

The 3VA5 molded case circuit breaker is suitable for numerous applications in infrastructure and industrial plants – and this applies worldwide thanks to IEC and UL certification.

Its additional functionality is the perfect complement to the circuit breaker series – and it features a consistent design and wide range of accessories.

Special features

- Compact design
- AC/DC applications
- Universal platform of accessories
- 1, 2, 2 in 3, 3 and 4-pole version
- Also available as a molded case switch and motor circuit protector
- Available in different sizes with rated currents from 1 ... 2000 A

UL certificate

- 3VA5/6 molded case circuit breaker for line protection E364397 (CCN ¹⁾: DIVQ)
- 3VA5/6 motor circuit protector: E482699 (CCN: DKPU2)
- 3VA5/6 molded case switch: E482701 (CCN: WJAZ)
- Accessories: E354102

¹⁾ CCN = UL Category Code Number



3VA61 ... 3VA69
molded case circuit breakers

Perfect for advanced applications

Whether in industry or infrastructure – the 3VA6 molded case circuit breaker can handle all tasks with ease. It can be easily integrated into higher-level energy management or automation systems.

It reliably signals plant conditions and measured values, helping you to increase plant availability and identify any potential for savings.

Special features

- Very good selective protection response
- AC applications
- Integrated measurement function for current, voltage and energy values
- Connection to a communication system
- Various circuit breaker versions available as "100% rated" (uninterrupted current carrying) and as „current limiting“ breaker according to UL 489
- Integrated DAS+ (Dynamic Arc-Flash Sentry) function in accordance with American standard NEC 240.87 to reduce arc flash energy in the switchboard for frame sizes 1200, 1600 and 2000 A (3VA UL Large Frame)
- Available in different sizes with rated currents from 25 ... 2000 A

UL certificate

- 3VA5/6 molded case circuit breaker for line protection E364397 (CCN ¹⁾: DIVQ)
- 3VA5/6 motor circuit protector: E482699 (CCN: DKPU2)
- 3VA5/6 molded case switch: E482701 (CCN: WJAZ)
- Accessories: E354102

¹⁾ CCN = UL Category Code Number

Molded case circuit breakers and accessories

2

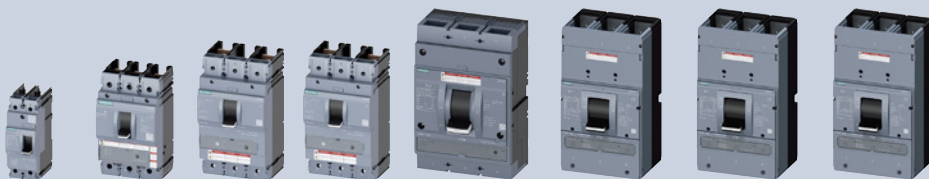

Protective functions

	3VA51	3VA52	3VA53	3VA54	3VA55	3VA57 new	3VA58 new	3VA59 new
Size	125 A	250 A	400 A	600 A	800 A	1200 A	1600 A	2000 A
Molded case switch (MCS)								
With short-circuit release for intrinsic device protection	■	■	■	■	■	■	■	■
Thermal-magnetic								
Line protection	■	■	■	■	■	■	■	■
Protective circuit breaker for motor starter combinations, motor circuit protector (MCP)	■	■	■	■	■	–	–	–
Electronic								
Line protection	–	–	–	–	–	–	–	–
Line protection, with display	–	–	–	–	–	–	–	–
Line protection, with display and measurement function	–	–	–	–	–	–	–	–
Protective circuit breaker for motor starter combinations, motor circuit protector (MCP)	–	–	–	–	–	–	–	–

Accessories

	125 A	250 A	400 A	600 A	800 A	1200 A	1600 A	2000 A
Size	125 A	250 A	400 A	600 A	800 A	1200 A	1600 A	2000 A
Accessories								
Auxiliary switches and signaling switches	■	■	■	■	■	■	■	■
Auxiliary releases	■	■	■	■	■	■	■	■
Connection technology	■	■	■	■	■	■	■	■
Plug-in version	–	–	–	–	–	–	–	–
Withdrawable version	–	–	–	–	–	–	–	–
Front mounted rotary operator	■	■	■	■	■	■	■	■
Door mounted rotary operator	■	■	■	■	■	■	■	■
Side wall mounted rotary operator	■	■	–	–	–	–	–	–
Operating unit with Bowden cable/linkage	■	■	■	■	–	–	–	–
Motor operator MO 320 (mounted on front)	■	■	■	■	–	–	–	–
Motor operator with SEO520 stored energy operator	–	■	–	–	–	–	–	–
Locking, blocking and interlocking	■	■	■	■	■	■	■	■
Communications interface	–	–	–	–	–	–	–	–
EFB300	–	–	–	–	–	–	–	–
MMB300	–	–	–	–	–	–	–	–
Testing and commissioning devices	–	–	–	–	–	–	–	–
Cover frame	■	■	■	■	■	■	■	■
Mounting plate for circuit breaker	–	–	–	–	–	–	●	●
Assembly kit for multiple feed-in terminals	–	–	–	–	–	■	■	–

● Must be used ■ Available – Not available/not present



3VA61 **3VA62** **3VA63** **3VA64** **3VA65** **3VA66** **3VA67** **new** **3VA68** **new** **3VA69** **new**

150 A 250 A 400 A 600 A 800 A 1000 A 1200 A 1600 A 2000 A

-	-	-	-	-	-	-	-	-
-	-	-	-	-	-	-	-	-
-	-	-	-	-	-	-	-	-
-	-	-	-	-	-	-	-	-
■	■	■	■	■	■	■	■	-
■	■	■	■	■	■	■	■	-
■	■	■	■	■	■	■	■	■
■	■	■	■	■	-	-	-	-

150 A 250 A 400 A 600 A 800 A 1000 A 1200 A 1600 A 2000 A

■	■	■	■	■	■	■	■	■
■	■	■	■	■	■	■	■	■
■	■	■	■	■	■	■	■	■
■	■	■	■	■	-	-	-	-
■	■	■	■	■	-	-	-	-
■	■	■	■	■	■	■	■	■
■	■	■	■	■	■	■	■	■
■	■	■	■	■	■	■	■	■
■	■	■	■	■	■	■	■	■
■	■	■	■	■	■	■	■	■
■	■	■	■	■	■	■	■	■
■	■	■	■	■	■	■	■	■
■	■	■	■	■	■	■	■	■
■	■	■	■	■	■	■	■	■
■	■	■	■	■	■	■	■	■
■	■	■	■	■	■	■	■	■
-	-	-	-	-	-	-	●	■
-	-	-	-	-	-	■	■	-

3VA5 molded case circuit breakers up to 2000 A

Technical data

2



			3VA51			3VA51			3VA51			3VA52		
Basic data														
Number of poles			1-pole			2-pole			3/4-pole			2 in 3-pole, 3/4-pole		
Size	A		125			125			125			250		
Rated current I_n	A		15 ... 125			15 ... 125			15 ... 125			40 ... 250		
Frequency	Hz		0 ... 400			0 ... 400			0 ... 400			0 ... 400		
Electrical characteristics according to UL 489														
Rated operational voltage U_e 50/60 Hz AC	V		347			600 Y/347 and 480			600 Y/347 and 480			600		
Electrical characteristics according to IEC 60947-2														
Rated operational voltage U_e 50/60 Hz AC	V		415			415			690			690		
Rated insulation voltage U_i	V		500			600			800			800		
Rated impulse withstand voltage U_{imp}	kV		8			8			8			8		
Breaking capacity (line protection)														
UL breaker type			S	M	H	S	M	H	S	M	H	M	H	C
Current Limiting according to UL489			SEAS	MEAS	HEAS	SEAS	MEAS	HEAS	SEAS	MEAS	HEAS	MFAS	HFAS	CFAS
Short-circuit breaking capacity acc. to UL 489														
50/60 Hz AC	120 V	kA	65	85	100	–	–	–	–	–	–	–	–	–
	240 V	kA	–	–	–	65	85	150	65	85	150	85	100	200
	277 V	kA	25	35	50	–	–	–	–	–	–	–	–	–
	347 V	kA	14	18	18	–	–	–	–	–	–	–	–	–
	480 Y/277 V	kA	–	–	–	25	35	65	25	35	65	35	65	100
	480 V	kA	–	–	–	25	35	65	25	35	65	35	65	100
	600 Y/347 V	kA	–	–	–	14	18	25	14	18	25	18	25	35
	600 V	kA	–	–	–	–	–	–	–	–	–	18	25	35
DC ¹⁾	125 V	kA	14	25	30	14	25	30	–	–	–	–	–	–
	250 V	kA	–	–	–	50	85	100	50	85	100	50	85	100
	500 V	kA	–	–	–	–	–	–	50	85	100	50	85	100
	600 V	kA	–	–	–	–	–	–	50	85	100	50	85	100
	750 V	kA	–	–	–	–	–	–	–	–	–	50	85	100
	1000 V	kA	–	–	–	–	–	–	–	–	–	50	85	100
Short-circuit breaking capacity acc. to IEC 60947-2														
Rated ultimate short-circuit breaking capacity I_{CU} 50/60 Hz AC ²⁾	240 V	kA	25	36	55	55	85	150	55	85	150	85	100	200
	415 V	kA	5	5	5	36	55	70	36	55	70	55	70	110 (3P) 85 (4P)
	690 V	kA	–	–	–	–	–	–	5	7	10	7	10	10
Rated service short-circuit breaking capacity I_{CS} 50/60 Hz AC ²⁾	240 V	kA	25	36	55	55	85	150	55	85	150	85	100	200
	415 V	kA	5	5	5	36	55	70	36	55	70	55	70	110 (3P) 85 (4P)
	690 V	kA	–	–	–	–	–	–	5	5	5	7	10	10
DC ¹⁾	125 V	kA	14	25	30	14	25	30	–	–	–	–	–	–
	250 V	kA	–	–	–	50	85	100	50	85	100	50	85	100
	500 V	kA	–	–	–	–	–	–	50	85	100	50	85	100
	600 V	kA	–	–	–	–	–	–	50	85	100	50	85	100
	750 V	kA	–	–	–	–	–	–	–	–	–	50	85	100
	1000 V	kA	–	–	–	–	–	–	–	–	–	25	36	50
Dimensions														
			A	mm		25.4	50.8	76.2				105		
			B	mm		140	140	140				185		
			C	mm		76.5	76.5	76.5				83		
			D	mm		93.4	93.4	93.4				107		

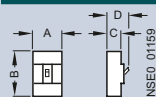

■ Available – Not available/not present

¹⁾ For detailed data on DC breaking capacity, number of interrupter poles and circuit diagrams, see FAQ www.siemens.com/lowvoltage/product-support (109775443)

**3VA53****3VA54****3VA55****3VA57** new**3VA58** new**3VA59** new

3VA53			3VA54			3VA55			3VA57			3VA58			3VA59		
2 in 3-pole, 3/4-pole			2 in 3-pole, 3/4-pole			2 in 3-pole, 3/4-pole			2 in 3-pole, 3-pole			3-pole			3-pole		
400			600			800			1200			1600			2000		
200 ... 400			450, 500, 600			600, 700, 800			800, 900, 1000, 1200			1400, 1600			1800, 2000		
0 ... 400			0 ... 400			0 ... 400			0 ... 400			0 ... 400			0 ... 400		
600			600			600			600			600			600		
690			690			690			690			690			-		
800			800			800			800			800			-		
8			8			8			8			8			-		
M	H	C	M	H	C	M	H	C	M	H	C	M	H	C	M	H	C
MJAS	HJAS	CJAS	MLAS	HLAS	CLAS	MMAS	HMAS	CMAS	MNAS	HNAS	CNAS	MPAS	HPAS	CPAS	MRAS	HRAS	CRAS
-	-	-	-	-	-	-	-	-	-	-	■	-	-	■	-	-	■
-	-	-	-	-	-	-	-	-	-	-	-	-	-	-	-	-	-
85	100	200	85	100	200	85	100	200	85	100	200	85	100	200	85	100	200
-	-	-	-	-	-	-	-	-	-	-	-	-	-	-	-	-	-
-	-	-	-	-	-	-	-	-	-	-	-	-	-	-	-	-	-
35	65	100	35	65	100	35	65	100	35	65	100	35	65	100	35	65	100
35	65	100	35	65	100	35	65	100	35	65	100	35	65	100	35	65	100
20	25	35	20	25	35	18	25	50	25	35	65	25	35	65	25	35	65
20	25	35	20	25	35	18	25	50	25	35	65	25	35	65	25	35	65
-	-	-	-	-	-	-	-	-	-	-	-	-	-	-	-	-	-
50	85	100	50	85	100	50	85	100	22	25	42	22	25	42	22	25	42
50	85	100	50	85	100	50	85	100	50	85	100	35	50	65	35	50	65
50	85	100	50	85	100	50	85	100	50	85	100	50	85	100	50	85	100
50	85	100	50	85	100	50	85	100	50	85	100	50	85	100	50	85	100
6	6	10	6	6	10	18	25	50	-	-	-	-	-	-	-	-	-
85	100	200	85	100	200	85	100	200	65	110	200	65	100	200	-	-	-
55	70	110	55	70	110	55	70	110	50	70	110	50	70	110	-	-	-
7	10	10	7	10	10	25	35	35	20	30	35	20	30	35	-	-	-
85	100	200	85	100	200	85	100	150	35	55	100	35	55	100	-	-	-
55	70	110	55	70	110	55	70	85	25	35	55	25	35	55	-	-	-
5	6	6	6	6	6	19	19	19	15	15	17	15	15	17	-	-	-
8	16	25	8	16	25	50	85	100	-	-	-	-	-	-	-	-	-
8	16	25	8	16	25	50	85	100	50	85	100	50	85	100	-	-	-
8	16	25	8	16	25	50	85	100	50	85	100	50	85	100	-	-	-
8	16	25	8	16	25	50	85	100	50	85	100	50	85	100	-	-	-
-	-	-	-	-	-	50	85	100	50	85	100	50	85	100	-	-	-
-	-	-	-	-	-	25	35	50	-	-	-	-	-	-	-	-	-
138			138			201			229			229			229		
210			210			328			406			406			406		
110			110			120			157			157			157		
137			137			253			208.9			208.9			208.9		

²⁾ I_{cu} = rated ultimate short-circuit breaking capacity, rms value, according to IEC 60947-2.
 I_{cs} = rated service short-circuit breaking capacity, rms value, according to IEC 60947-2.

3VA5 molded case circuit breakers up to 2000 A

Application

2



3VA51



3VA51



3VA51



3VA52

Basic data			3VA51	3VA51	3VA51	3VA52
Number of poles			1-pole	2-pole	3/4-pole	2 in 3-pole, 3/4-pole
Size	A		125	125	125	250
Rated current I_n	A		15 ... 125	15 ... 125	15 ... 125	40 ... 250
Frequency	Hz		0 ... 400	0 ... 400	0 ... 400	0 ... 400
3VA5 molded case circuit breakers for line protection						
Service life/endurance (operating cycles)						
Mechanical (OPEN-CLOSE cycles)			20000	20000	20000	20000
Electrical for U_e 480 V (UL 489)/415 V (IEC 60947)			8000	8000	8000	8000
Trip units						
FTFM	TM210		■	■	■	■
FTAM	TM230		–	–	■	■
ATAM	TM240		–	–	■	■
3VA5 motor circuit protector (protective circuit breaker for motor starter combinations)						
Rated current I_n	A		–	–	15 ... 125	150 ... 200
Breaking capacity acc. to UL 489 without contactor at 480 V ¹⁾	kA		–	–	65	65/100
Approval acc. to IEC 60947-2 Annex O ICB			–	–	■	■
Integrated, instantaneous short-circuit release for intrinsic device protection						
AM	TM120M		–	–	■	■
3VA5 molded case switch						
Electrical characteristics according to UL 489						
Rated uninterrupted current I_n at 40 °C ambient temperature for short-circuit current rating (SCCR) ²⁾	Up to 65 kA at 480 V	A	–	100	100	150, 250
	Up to 100 kA at 480 V	A	–	–	–	100, 150, 250
Approval acc. to IEC 60947-2 Annex L CBI-X			–	■	■	■
Integrated, instantaneous short-circuit release for intrinsic device protection						
FM	MCS110		–	■	■	■
Standards and specifications						
Standards and specifications			UL489/cULus, IEC 60947-2	UL489/cULus, IEC 60947-2	UL489/cULus, IEC 60947-2	UL489/cULus, IEC 60947-2
Direction of power flow and infeed			Top and bottom	Top and bottom	Top and bottom	Top and bottom
Standard connection technology			Without connection technology	Without connection technology	Without connection technology	Without connection technology

■ Available – Not available/not present

¹⁾ Breaking capacity in combinations with contactor (SCCR rating) may differ

²⁾ The breaking capacity (SCCR rating) is the maximum short-circuit current permissible at the location where the MCS is installed in conjunction with a suitable overload protection device

**3VA53****3VA54****3VA55****3VA57** new**3VA58** new**3VA59** new

3VA53	3VA54	3VA55	3VA57	3VA58	3VA59
2 in 3-pole, 3/4-pole	2 in 3-pole, 3/4-pole	2 in 3-pole, 3/4-pole	2 in 3-pole, 3-pole	3-pole	3-pole
400	600	800	1200	1600	2000
200 ... 400	450, 500, 600	600, 700, 800	800, 900, 1000, 1200	1400, 1600	1800, 2000
0 ... 400	0 ... 400	0 ... 400	0 ... 400	0 ... 400	0 ... 400
20000	20000	10000	3000	3000	3000
6000	3000	4800	1500	1500	500
–	–	–	–	–	–
■	■	■	■	■	■
■	■	–	–	–	–
250	400, 500, 600	600, 800	–	–	–
65/100	65/100	65/100	–	–	–
■	■	■	–	–	–
■	■	■	–	–	–
400	600	800	1000, 1200	1600	2000
400	600	800	1000, 1200	1600	2000
■	■	■	■	■	–
■	■	■	■	■	■
UL489/cULus, IEC 60947-2	UL489/cULus, IEC 60947-2	UL489/cULus, IEC 60947-2	UL489/cULus, IEC 60947-2	UL489/cULus, IEC 60947-2	UL 489/cULus
Top and bottom	Top and bottom	Top and bottom	Top and bottom	Top and bottom	Top and bottom
Without connection technology	Without connection technology	Nut keeper kit	Without connection technology	Without connection technology	Without connection technology

3VA6 molded case circuit breakers up to 2000 A

Technical data

2



3VA61



3VA62

Basic data			3VA61					3VA62				
Number of poles			3/4-pole					3/4-pole				
Size	A		150					250				
Rated current I_n	A		40 ... 150					100, 250				
Frequency	Hz		50 ... 60					50 ... 60				
Electrical characteristics according to UL 489												
Rated operational voltage U_e 50/60 Hz AC	V		600					600				
Electrical characteristics according to IEC 60947-2												
Rated operational voltage U_e 50/60 Hz AC	V		690					690				
Rated insulation voltage U_i	V		800					800				
Rated impulse withstand voltage U_{imp}	kV		8					8				
Breaking capacity (line protection)			M	H	C	L	E	M	H	C	L	E
UL breaker type			MDAE	HDAE	CDAE	LDAE	EDAE	MFAE	HFAE	CFAE	LFAE	EFAE
Current limiting according to UL 489			–	–	–	–	■	–	–	–	–	■
Short-circuit breaking capacity acc. to UL 489												
50/60 Hz AC												
	120 V	kA	–	–	–	–	–	–	–	–	–	–
	240 V	kA	100	100	200	200	–	100	100	200	200	–
	277 V	kA	–	–	–	–	–	–	–	–	–	–
	347 V	kA	–	–	–	–	–	–	–	–	–	–
	480 Y/277 V	kA	35	65	100	150	200	35	65	100	150	200
	480 V	kA	35	65	100	150	200	35	65	100	150	200
	600 Y/347 V	kA	18	22	35	50	100	18	22	35	50	100
	600 V	kA	18	22	35	50	100	18	22	35	50	100
Short-circuit breaking capacity acc. to IEC 60947-2												
Rated ultimate short-circuit breaking capacity I_{CU} 50/60 Hz AC ¹⁾	240 V	kA	85	110	150	200	–	85	110	150	200	–
	415 V	kA	55	85	110	150	150	55	85	110	150	150
	690 V	kA	2.5	2.5	2.5	2.5	3	3	3	3	3	3
Rated service short-circuit breaking capacity I_{CS} 50/60 Hz AC ¹⁾	240 V	kA	85	110	150	200	–	85	110	150	200	–
	415 V	kA	55	85	110	150	150	55	85	110	150	150
	690 V	kA	2.5	2.5	2.5	2.5	3	3	3	3	3	3
Dimensions												
	A	mm	105 (3P) 140 (4P)					105 (3P) 140 (4P)				
	B	mm	198					198				
	C	mm	86					86				
	D	mm	107					107				

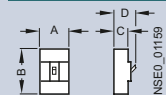

■ Available – Not available/not present

¹⁾ I_{CU} = rated ultimate short-circuit breaking capacity, rms value, according to IEC 60947-2.
 I_{CS} = rated service short-circuit breaking capacity, rms value, according to IEC 60947-2.



3VA63



3VA64



3VA65



3VA66

3VA67
new3VA68
new3VA69
new

3VA63				3VA64				3VA65				3VA66				3VA67 new				3VA68 new				3VA69 new							
3/4-pole				3/4-pole				3/4-pole				3/4-pole				3-pole				3-pole				3-pole							
400				600				800				1000				1200				1600				2000							
250, 400				400, 600				600, 800				1000				800, 1000, 1200				1600				2000							
50 ... 60				50 ... 60				50 ... 60				50 ... 60				50 ... 60				50 ... 60				50 ... 60							
600				600				600				600				600				600				600							
690				690				690				690				690				690				690				-			
800				800				800				800				800				800				800				-			
8				8				8				8				8				8				8				-			
M	H	C	L	E	M	H	C	L	E	M	H	C	M	H	C	M	H	C	M	H	C	M	H	C							
MJAE	HJAE	CJAE	LJAE	EJAE	MLAE	HLAE	CLAE	LLAE	ELAE	MMAE	HMAE	CMAE	MM-NAE	HM-NAE	CM-NAE	MNAE	HNAE	CNAE	MPAE	HPAE	CPAE	MRAE	HRAE	CRAE							
-	-	-	-	■	-	-	-	-	■	-	-	-	-	-	-	-	-	-	■	-	-	■	-	-	■						
-	-	-	-	-	-	-	-	-	-	-	-	-	-	-	-	-	-	-	-	-	-	-	-	-	-						
100	100	200	200	-	100	100	200	200	-	100	150	200	100	150	200	85	100	200	85	100	200	85	100	200							
-	-	-	-	-	-	-	-	-	-	-	-	-	-	-	-	-	-	-	-	-	-	-	-	-	-						
-	-	-	-	-	-	-	-	-	-	-	-	-	-	-	-	-	-	-	-	-	-	-	-	-	-						
35	65	100	150	200	35	65	100	150	200	35	65	100	35	65	100	35	65	100	35	65	100	35	65	100							
35	65	100	150	200	35	65	100	150	200	35	65	100	35	65	100	35	65	100	35	65	100	35	65	100							
18	22	35	50	100	18	22	35	50	100	25	35	50	25	35	50	25	35	65	25	35	65	25	35	65							
18	22	35	50	100	18	22	35	50	100	25	35	50	25	35	50	25	35	65	25	35	65	25	35	65							
-	-	-	-	-	-	-	-	-	-	-	-	-	-	-	-	-	-	-	-	-	-	-	-	-	-						
85	110	150	200	-	85	110	150	200	-	85	110	200	85	110	200	65	110	200	65	110	200	-	-	-							
55	85	110	150	150	55	85	110	150	150	55	85	110	55	85	110	50	70	110	50	70	110	-	-	-							
5	5	5	5	6	6	6	6	6	6	25	35	35	25	35	35	20	30	35	20	30	35	-	-	-							
85	110	150	200	-	85	110	150	200	-	85	110	150	85	110	150	35	55	100	35	55	100	-	-	-							
55	85	110	150	150	55	85	110	150	150	55	85	85	55	85	85	25	35	50	25	35	50	-	-	-							
5	5	5	5	6	6	6	6	6	6	19	19	19	19	19	19	15	15	17	15	15	17	-	-	-							
138 (3P) 184 (4P)				138 (3P) 184 (4P)				210				210				229				229				229							
248				248				328				328				406				406				406							
110				110				120				120				157				157				157							
137				137				253				253				208.9				208.9				208.9							

3VA6 molded case circuit breakers up to 2000 A

Application

2



		3VA61	3VA62
Basic data			
Number of poles		3/4-pole	3/4-pole
Size	A	150	250
Rated current I_n	A	40 ... 150	100, 250
Frequency	Hz	50 ... 60	50 ... 60
3VA6 molded case circuit breakers for line protection			
Service life/endurance (operating cycles)			
Mechanical (CLOSE-OPEN cycles)		25000	25000
Electrical for U_e 480 V (UL 489)/415 V (IEC 60947)		14000	12000
Trip units			
LI	ETU320	■	■
	ETU820	■	■
LIG	ETU330	■	■
	ETU830	■	■
LSI	ETU350	■	■
	ETU550	■	■
	ETU850	■	■
LSI (G alarm, no integrated G protection)	ETU556	■	■
	ETU856	■	■
LSIG	ETU360	–	–
	ETU560	■	■
	ETU860	■	■
Motor circuit protector (protective circuit breaker for motor starter combinations) 3VA6			
Rated current I_n	A	25 ... 100	110 ... 200
Breaking capacity acc. to UL 489 without contactor at 480 V ¹⁾	kA	100	100
Approval acc. to IEC 60947-2 Annex O ICB		■	■
Integrated, instantaneous short-circuit release for intrinsic device protection			
I	ETU310M	■	■
Standards and specifications			
Standards and specifications		UL489/cULus, IEC 60947-2	UL489/cULus, IEC 60947-2
Direction of power flow and infeed		Top and bottom	Top and bottom
Standard connection technology		Without connection technology	Without connection technology

■ Available – Not available/not present





















¹⁾ Breaking capacity in combinations with contactor (SCCR rating) may differ



3VA63	3VA64	3VA65	3VA66	3VA67 new	3VA68 new	3VA69 new
3/4-pole	3/4-pole	3/4-pole	3/4-pole	3-pole	3-pole	3-pole
400	600	800	1000	1200	1600	2000
250, 400	400, 600	600, 800	1000	800, 1000, 1200	1600	2000
50 ... 60	50 ... 60	50 ... 60	50 ... 60	50 ... 60	50 ... 60	50 ... 60
20000	20000	10000	10000	3000	3000	3000
6000	4000	5100	4900	1500	1500	500
■	■	■	■	■	■	-
■	■	■	■	■	■	-
■	■	■	■	■	■	-
■	■	■	■	■	■	-
■	■	■	■	-	-	-
■	■	-	-	■	■	■
■	■	■	■	-	-	-
■	■	■	■	■	■	■
■	■	■	■	■	■	■
200, 250	400, 500	800	-	-	-	-
100	100	100	-	-	-	-
■	■	■	-	-	-	-
■	■	■	-	-	-	-
UL489/cULus, IEC 60947-2	UL489/cULus, IEC 60947-2	UL489/cULus, IEC 60947-2	UL489/cULus, IEC 60947-2	UL 489/cULus, IEC 60947-2	UL 489/cULus, IEC 60947-2	UL 489/cULus
Top and bottom	Top and bottom	Top and bottom	Top and bottom	Top and bottom	Top and bottom	Top and bottom
Without connection technology	Without connection technology	Nut keeper kit	Nut keeper kit	Without connection technology	Without connection technology	Without connection technology

Trip units

Protection system for 3VA molded case circuit breakers up to 2000 A

Trip units	Thermal-magnetic	Electronic	Electronic with display	Electronic with display and measurement function
				
	TM 2-series	ETU 3-series	ETU 5-series	ETU 8-series
Protective function				
Line protection	TM210, TM230, TM240	ETU320, ETU330, ETU350, ETU360	ETU550, ETU556, ETU560	ETU820, ETU830, ETU850, ETU856, ETU860
Starter protection	TM120M	ETU310M	–	–
Integrated functions				
Parameterizing	Setting and reading the parameters <ul style="list-style-type: none"> In A 	Setting and reading the parameters <ul style="list-style-type: none"> In A and s 	Setting and reading the parameters <ul style="list-style-type: none"> Via display and communication Fine setting of the parameters Reading the measured values 	Setting and reading the parameters <ul style="list-style-type: none"> Via display and communication Fine setting of the parameters Reading the measured values
Status display	–	Indicating the ETU status via LEDs	Indicating the ETU status via LEDs	Indicating the ETU status via LEDs
Interface	–	Interface for test devices	Interface for test devices	Interface for test devices
Measurement function	–	–	–	Measurement function integrated
Optional expansions				
24 V module	–	–	 24 V module for continuous power supply (also without primary current through the molded case circuit breaker)	 24 V module for continuous power supply (also without primary current through the molded case circuit breaker)
External function box	–	 EFB300 external function box for connection to the ETU	 EFB300 external function box for connection to the ETU	 EFB300 external function box for connection to the ETU
Maintenance mode box	–	 MMB300 maintenance mode box for connection to the ETU ¹⁾	 MMB300 maintenance mode box for connection to the ETU	 MMB300 maintenance mode box for connection to the ETU ¹⁾
Communication module	–	–	 COM060 communication module	 COM060 communication module ¹⁾
Data concentrator	–	–	 COM800/COM100 breaker data server with interface to <ul style="list-style-type: none"> PROFIBUS PROFINET Modbus RTU Ethernet (Modbus TCP) 	 COM800/COM100 breaker data server with interface to <ul style="list-style-type: none"> PROFIBUS PROFINET Modbus RTU Ethernet (Modbus TCP)
External display	–	–	 DSP800 external display for installing in the cubicle door	 DSP800 external display for installing in the cubicle door
Test device	–	 TD300/TD400/TD500 test device	 TD300/TD400/TD500 test device	 TD300/TD400/TD500 test device

¹⁾ For 3VA67, 3VA68 and 3VA69 (3VA UL Large Frame), this function is already integrated in the ETU

Protective functions of the 3VA5 with thermal-magnetic trip unit

	TM120M AM	TM210 FTFM	TM230 FTAM	TM240 ATAM
Protection				
Motor circuit protector	■	–	–	–
Line protection	–	■	■	■
Version available with				
1-pole breaker	–	■	–	–
2-pole breaker in 3-pole enclosure	–	■	■	–
3-pole breaker	■	■	■	■
4-pole breaker	–	■	■	■
Available protection parameters				
I_r adjustable	–	–	–	■
I_i adjustable	■	–	■	■
I_r fixed	–	■	■	–
I_i fixed	–	■	–	–

2

Protective functions of the 3VA6 with electronic trip unit

	ETU310M I	ETU320 LI	ETU330 LIG	ETU350 LSI	ETU360 LSIG	ETU550 LSI	ETU556 LSI (G alarm)	ETU560 LSIG	ETU820 LI	ETU830 LIG	ETU850 LSI	ETU856 LSI (G alarm)	ETU860 LSIG
Protection													
Motor circuit protector	■	–	–	–	–	–	–	–	–	–	–	–	–
Line protection	–	■	■	■	■	■	■	■	■	■	■	■	■
Version available with													
3-pole without external neutral conductor transformer	■	■	■	■	–	–	–	–	–	–	–	–	–
3-pole with external neutral conductor transformer	–	–	–	–	■	■	■	■	–	–	■	■	■
4-pole with protected neutral conductor transformer	–	■	■	■	–	■	■	■	■	■	■	■	■
Available protection parameters													
Characteristic in L range	I^2t	I^2t	I^2t	I^2t	I^2t	I^2t	I^2t	I^2t	I^2t	I^2t	I^2t	I^2t	I^2t
I_r	–	■	■	■	■	■	■	■	■	■	■	■	■
t_{sd} at $6 \times I_r$	–	■	■	■	■	■	■	■	■	■	■	■	■
Thermal image	■	■	■	■	■	■	■	■	■	■	■	■	■
Thermal image can be switched on/off	–	–	–	–	–	■	■	■	–	–	■	■	■
I_{sd}	–	–	–	■	■	■	■	■	–	–	■	■	■
t_{sd} at $8 \times I_r$	–	–	–	■	■	■	■	■	–	–	■	■	■
Characteristic in S range: I^2t_{sd}	–	–	–	■	■	■	■	■	–	–	■	■	■
Characteristic in S range: selectable I^2t_{sd}/t_{sd}	–	–	–	–	–	■	■	■	–	–	■	■	■
I_i	■	■	■	■	■	■	■	■	■	■	■	■	■
I_N ¹⁾	–	■	■	■	■	■	■	■	■	■	■	■	■
I_g	–	–	■	–	■	–	–	■	–	■	–	–	■
t_g at $2 \times I_g$	–	–	■	–	■	–	–	■	–	■	–	–	■
Characteristic in G range: I^2t_g	–	–	–	–	–	–	–	■	–	■	–	–	■
Characteristic in G range: selectable I^2t_g/t_g	–	–	–	–	–	–	–	■	–	■	–	–	■
Ground-fault alarm function	–	–	–	–	–	–	■	■	–	–	–	■	■
ZSI	–	■	■	■	■	■	■	■	■	■	■	■	■
Arc fault mitigation mode	–	■	■	■	■	■	■	■	■	■	■	■	■

■ Available – Not available/not present

¹⁾ Available for circuit breakers with an external current transformer for the neutral conductor and for 4-pole circuit breakers

Online configurator highlights

www.siemens.com/lowvoltage/configurators

Search function with global direct input

Searches for specific terms and jumps to article number based on input to the correct configurator

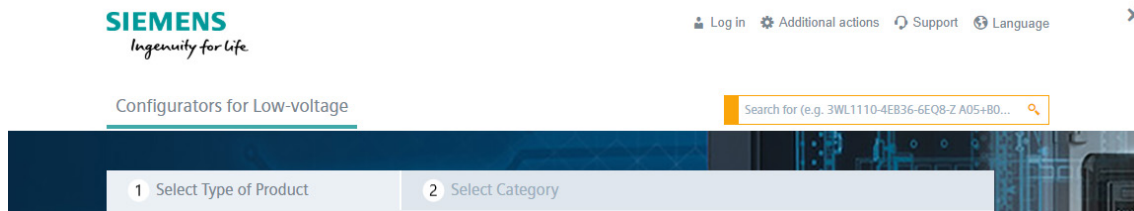

Product list stores multiple configurations and can transfer them collectively to the shopping cart

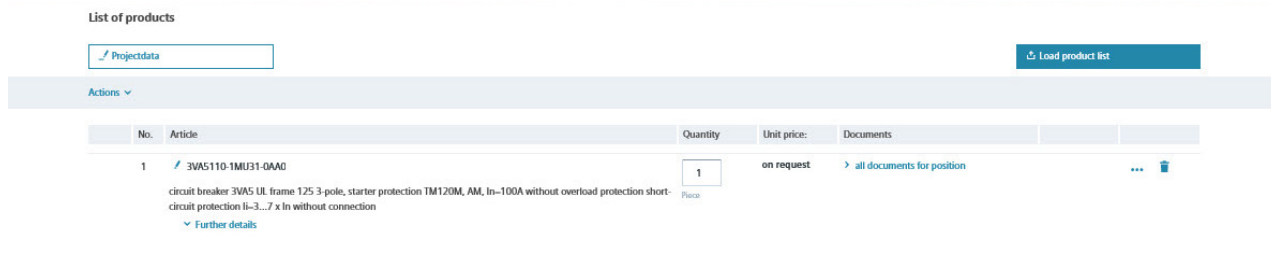

Recall of completed configurations for modification or additional configuration

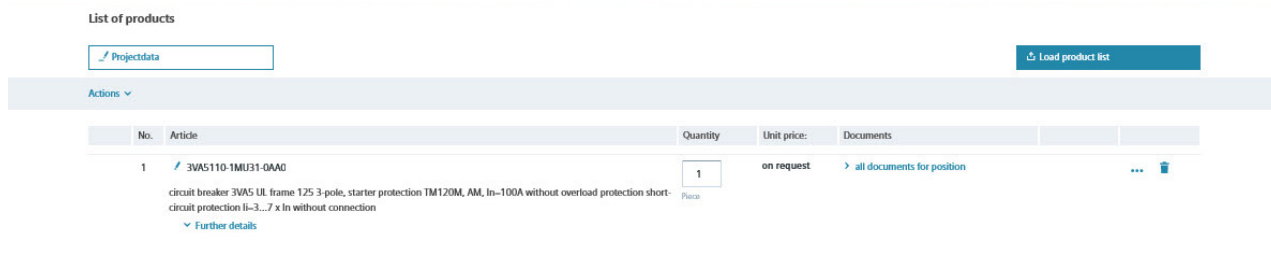

Responsive Design

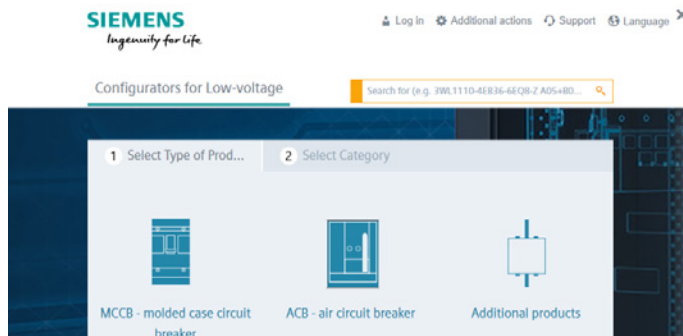

www.siemens.com/lowvoltage/3va-ul-configurator

Visualization of the internally mountable accessories (slot assignment)

✓ The configuration is complete. You can order this product. Filter (e.g. "power", ...)

Basic breaker | Trip Unit | Type of mounting | Aux Release & Aux Switch | **Mountable accessories** | Result | CAD/CAE 2020_05.13

Assembly option

Field Assembly

Auxiliary release

- Shunt trip left (STL) Without
- Shunt trip flexible (STF) Without
- Undervoltage release (UVR) Without
- Universal release (UNI) Without

Slot assignment

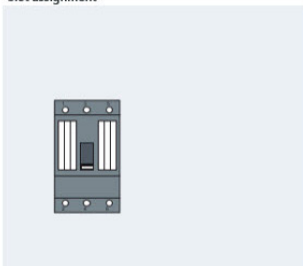

Auxiliary switch/alarm switch (changeover contacts - Form C)

Auxiliary switch type HP

- AUX auxiliary switch
- LCS leading auxiliary switch

Auxiliary switch type HQ

- AUX auxiliary switch
- AUX auxiliary switch, suitable for electronic circuits
- LCS leading auxiliary switch
- LCS leading auxiliary switch, suitable for electronic circuits

Alarm switch type HP

- TAS alarm switch

Alarm switch type HQ

- TAS alarm switch
- TAS alarm switch, suitable for electronic circuits

2

Download of the individual edz files for 3VA

SIEMENS *Ingenuity for life* Additional actions | List of products | Support | Language

✓ The configuration is complete. You can order this product. Filter (e.g. "power", ...)

Basic breaker | Trip Unit | Type of mounting | Aux Release & Aux Switch | **Mountable accessories** | Result | CAD/CAE 2020_05.13

Selection

- Assembly drawing
- 3VA-UL molded-case circuit breaker

Preview

Wire frame view | 3D view | Dimension drawing | Area Model View | Unit Wiring Diagram IEC

Documentation and reporting

Choose languages for the data sheet: deutsch

Project data for the datasheet

Download selection of document types

- Datasheets (PDF)

Selection of download format

- All in a ZIP file

Component documentation

- 3VA5110-1MU31-0AA0
- Datasheet (PDF)

© Siemens AG | Application Information

Download – all CAD formats

View: Area Model View

View option: Dimetric

File type: Bitmap (*.bmp)

Start generation

Download – all documents

open documents dialog

Automatic generation of the 3D model, the 2D dimension drawing and the internal circuit diagram according to IEC

✓ The configuration is complete. You can order this product. Filter (e.g. "power", ...)

Basic breaker | Trip Unit | Type of mounting | Aux Release & Aux Switch | **Mountable accessories** | Result | CAD/CAE 2020_05.13

Selection

- Assembly drawing
- 3VA-UL molded-case circuit breaker

Preview

Wire frame view | 3D view | Dimension drawing | Area Model View | Unit Wiring Diagram IEC

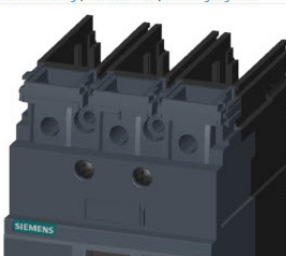

Download – all CAD formats

View: Area Model View

View option: Dimetric

File type: Bitmap (*.bmp)

Start generation

Download – all documents

open documents dialog

System overview

For a complete and valid configuration of your molded case circuit breaker, please use our online configurator at www.siemens.com/lowvoltage/3va-ul-configurator

2

Molded case circuit breakers



3VA5 for standard applications



3VA6 for applications with more stringent requirements

Trip unit



Thermal-magnetic trip unit (TMTU)

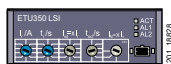

Electronic trip unit (ETU)



Electronic trip unit (ETU) with display, and optionally with measurement function

Trip unit accessories



24 V module



Communication module



Breaker data server



External display



Test device

Type of mounting



Fixed-mounted



Withdrawable unit, complete kit



Plug-in unit, complete kit

Supplementary accessories



Auxiliary circuit connector



Door feedthrough



Position signaling switch



Cylinder lock adapter



Crank

Main conductor connections



Bus connectors



Bus connectors broadened



Circular conductor terminal



Box terminal

Connection accessories



Insulation accessories

Note:

You will find a detailed range of accessories in the Accessories section.

Auxiliary releases/ auxiliary switches



Shunt trip STF/STL

Universal release
UNIUndervoltage
release UVRAuxiliary switch
AUXTrip alarm switch
TASLeading changeover
switch LCSElectrical alarm switch
EAS

Mountable accessories



Manual operator



Motor operator



Operating unit with Bowden cable



Operating unit with linkage

Additional circuit breaker accessories



Cover frame



Locking provision



Cylinder lock

Mechanical interlocking mechanisms

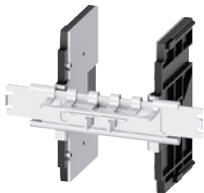

Sliding bar interlock



Interlocking with rod



Handle interlocking module with bowden cable

Note:

You will find a detailed range of accessories in the Accessories section.

Structure of the article numbers

Basic configuration for line protection

The structure shown below is intended as an overview of each position and its meaning. For a complete and valid configuration of your molded case circuit breaker, please use our online configurator at www.siemens.com/lowvoltage/3va-ul-configurator

2

3VA 4 5 6 7 8 9 10 11 12 13 AAO

Trip units															5	6				
	Thermal-magnetic														■	■				
	Electronic														■	■				
		3VA51	3VA52	3VA53	3VA54	3VA55	3VA57	3VA58	3VA59	3VA61	3VA62	3VA63	3VA64	3VA65	3VA66	3VA67	3VA68	3VA69		
Size	125 A	■	-	-	-	-	-	-	-	-	-	-	-	-	-	-	-	-	1	
	150 A	-	-	-	-	-	-	-	-	-	■	-	-	-	-	-	-	-	1	
	250 A	-	■	-	-	-	-	-	-	-	■	-	-	-	-	-	-	-	2	
	400 A	-	-	■	-	-	-	-	-	-	-	■	-	-	-	-	-	-	3	
	600 A	-	-	-	■	-	-	-	-	-	-	-	■	-	-	-	-	-	4	
	800 A	-	-	-	-	■	-	-	-	-	-	-	■	-	-	-	-	-	5	
	1000 A	-	-	-	-	-	-	-	-	-	-	-	-	■	-	-	-	-	6	
	1200 A	-	-	-	-	-	■	-	-	-	-	-	-	-	■	-	-	-	7	
	1600 A	-	-	-	-	-	-	■	-	-	-	-	-	-	-	■	-	-	8	
2000 A	-	-	-	-	-	-	-	■	-	-	-	-	-	-	-	■	-	9		
Max. rated current I_n	Line protection																			
	15 A	■	-	-	-	-	-	-	-	-	-	-	-	-	-	-	-	-	9	5
	20 A	■	-	-	-	-	-	-	-	-	-	-	-	-	-	-	-	-	2	0
	25 A	■	-	-	-	-	-	-	-	-	-	-	-	-	-	-	-	-	2	5
	30 A	■	-	-	-	-	-	-	-	-	-	-	-	-	-	-	-	-	3	0
	35 A	■	-	-	-	-	-	-	-	-	-	-	-	-	-	-	-	-	3	5
	40 A	■	■	-	-	-	-	-	-	■ ¹⁾	-	-	-	-	-	-	-	-	4	0
	45 A	■	■	-	-	-	-	-	-	-	-	-	-	-	-	-	-	-	4	5
	50 A	■	■	-	-	-	-	-	-	-	-	-	-	-	-	-	-	-	5	0
	60 A	■	■	-	-	-	-	-	-	■ ²⁾	-	-	-	-	-	-	-	-	6	0
	70 A	■	■	-	-	-	-	-	-	-	-	-	-	-	-	-	-	-	7	0
	80 A	■	■	-	-	-	-	-	-	-	-	-	-	-	-	-	-	-	8	0
	90 A	■	■	-	-	-	-	-	-	-	-	-	-	-	-	-	-	-	9	0
	100 A	■	■	-	-	-	-	-	-	■	■	-	-	-	-	-	-	-	1	0
	110 A	■	■	-	-	-	-	-	-	-	-	-	-	-	-	-	-	-	1	1
	125 A	■	■	-	-	-	-	-	-	-	-	-	-	-	-	-	-	-	1	2
	150 A	-	■	■	-	-	-	-	-	■	-	-	-	-	-	-	-	-	1	5
	175 A	-	■	■	-	-	-	-	-	-	-	-	-	-	-	-	-	-	1	7
	200 A	-	■	■	■	-	-	-	-	-	-	-	-	-	-	-	-	-	2	0
	225 A	-	■	■	■	■	-	-	-	-	-	-	-	-	-	-	-	-	2	2
250 A	-	■	■	■	■	-	-	-	■	■	-	-	-	-	-	-	-	2	5	
300 A	-	-	■	■	■	-	-	-	-	-	-	-	-	-	-	-	-	3	0	
350 A	-	-	■	■	■	-	-	-	-	-	-	-	-	-	-	-	-	3	5	
400 A	-	-	■	■	■	-	-	-	-	■	■	-	-	-	-	-	-	4	0	
450 A	-	-	■	■	■	-	-	-	-	-	-	-	-	-	-	-	-	4	5	
500 A	-	-	-	■	■	-	-	-	-	-	-	-	-	-	-	-	-	5	0	
600 A	-	-	-	■	■	■	-	-	-	-	■	■	-	-	-	-	-	6	0	
700 A	-	-	-	■	■	■	-	-	-	-	-	■	■	-	-	-	-	7	0	
800 A	-	-	-	■	■	■	■	-	-	-	-	■	■	■	-	-	-	8	0	
900 A	-	-	-	■	■	■	■	-	-	-	-	■	■	■	■	-	-	9	0	
1000 A	-	-	-	■	■	■	■	-	-	-	-	■	■	■	■	-	-	1	0	
1200 A	-	-	-	■	■	■	■	-	-	-	-	■	■	■	■	-	-	1	2	
1400 A	-	-	-	■	■	■	■	■	-	-	-	■	■	■	■	-	-	1	4	
1600 A	-	-	-	■	■	■	■	■	-	-	-	■	■	■	■	-	-	1	6	
1800 A	-	-	-	■	■	■	■	■	■	-	-	■	■	■	■	-	-	1	8	
2000 A	-	-	-	■	■	■	■	■	■	■	-	■	■	■	■	■	-	2	0	
Short-circuit breaking capacity at 480 V 50/60 Hz	25 kA	■	-	-	-	-	-	-	-	-	-	-	-	-	-	-	-		4	
	35 kA	■	■	■	■	■	■	■	■	■	■	■	■	■	■	■	■		5	
	65 kA	■	■	■	■	■	■	■	■	■	■	■	■	■	■	■	■		6	
	100 kA	-	■	■	■	■	■	■	■	■	■	■	■	■	■	■	■		7	
	150 kA	-	-	■	■	■	■	■	■	■	■	■	■	■	■	■	■		8	
	200 kA	-	-	-	■	■	■	■	■	■	■	■	■	■	■	■	■		0	

¹⁾ Available for breaking capacity classes M (35 kA), H (65 kA), C (100 kA) and L (150 kA) at 480 V
²⁾ Available for breaking capacity class E (200 kA) at 480 V
 ■ Available - Not available/not present

		3VA	4	5	6	7	8	9	10	11	12	13	AA0										
Protective function thermal-magnetic	Line protection	<input checked="" type="checkbox"/>	<input checked="" type="checkbox"/>	<input checked="" type="checkbox"/>	<input checked="" type="checkbox"/>	<input checked="" type="checkbox"/>	<input checked="" type="checkbox"/>	<input checked="" type="checkbox"/>	<input checked="" type="checkbox"/>	<input checked="" type="checkbox"/>	<input checked="" type="checkbox"/>	<input checked="" type="checkbox"/>	<input checked="" type="checkbox"/>	TM210	FTFM		D						
		<input checked="" type="checkbox"/>	<input checked="" type="checkbox"/>	<input checked="" type="checkbox"/>	<input checked="" type="checkbox"/>	<input checked="" type="checkbox"/>	<input checked="" type="checkbox"/>	<input checked="" type="checkbox"/>	<input checked="" type="checkbox"/>	<input checked="" type="checkbox"/>	<input checked="" type="checkbox"/>	<input checked="" type="checkbox"/>	<input checked="" type="checkbox"/>	<input checked="" type="checkbox"/>	TM230	FTAM		C					
		<input checked="" type="checkbox"/>	<input checked="" type="checkbox"/>	<input checked="" type="checkbox"/>	<input checked="" type="checkbox"/>	<input checked="" type="checkbox"/>	<input checked="" type="checkbox"/>	<input checked="" type="checkbox"/>	<input checked="" type="checkbox"/>	<input checked="" type="checkbox"/>	<input checked="" type="checkbox"/>	<input checked="" type="checkbox"/>	<input checked="" type="checkbox"/>	<input checked="" type="checkbox"/>	TM240	ATAM		F					
	Line protection	Without neutral conductor protection											E										
100% neutral conductor protection											G												
Protective function electronic	Line protection	<input type="checkbox"/>	<input type="checkbox"/>	<input type="checkbox"/>	<input type="checkbox"/>	<input type="checkbox"/>	<input type="checkbox"/>	<input type="checkbox"/>	<input type="checkbox"/>	<input type="checkbox"/>	<input type="checkbox"/>	<input type="checkbox"/>	<input type="checkbox"/>	<input type="checkbox"/>	<input type="checkbox"/>	<input type="checkbox"/>	<input type="checkbox"/>	ETU320	LI	(N) ¹⁾	H	L	
		<input type="checkbox"/>	<input type="checkbox"/>	<input type="checkbox"/>	<input type="checkbox"/>	<input type="checkbox"/>	<input type="checkbox"/>	<input type="checkbox"/>	<input type="checkbox"/>	<input type="checkbox"/>	<input type="checkbox"/>	<input type="checkbox"/>	<input type="checkbox"/>	<input type="checkbox"/>	<input type="checkbox"/>	<input type="checkbox"/>	<input type="checkbox"/>	<input type="checkbox"/>	ETU330	LIG	(N) ¹⁾	H	M
		<input type="checkbox"/>	<input type="checkbox"/>	<input type="checkbox"/>	<input type="checkbox"/>	<input type="checkbox"/>	<input type="checkbox"/>	<input type="checkbox"/>	<input type="checkbox"/>	<input type="checkbox"/>	<input type="checkbox"/>	<input type="checkbox"/>	<input type="checkbox"/>	<input type="checkbox"/>	<input type="checkbox"/>	<input type="checkbox"/>	<input type="checkbox"/>	<input type="checkbox"/>	ETU350	LSI	(N) ¹⁾	H	N
		<input type="checkbox"/>	<input type="checkbox"/>	<input type="checkbox"/>	<input type="checkbox"/>	<input type="checkbox"/>	<input type="checkbox"/>	<input type="checkbox"/>	<input type="checkbox"/>	<input type="checkbox"/>	<input type="checkbox"/>	<input type="checkbox"/>	<input type="checkbox"/>	<input type="checkbox"/>	<input type="checkbox"/>	<input type="checkbox"/>	<input type="checkbox"/>	<input checked="" type="checkbox"/>	ETU360	LSIG	(N) ¹⁾	H	Q
	Line protection, with display	<input type="checkbox"/>	<input type="checkbox"/>	<input type="checkbox"/>	<input type="checkbox"/>	<input type="checkbox"/>	<input type="checkbox"/>	<input type="checkbox"/>	<input type="checkbox"/>	<input type="checkbox"/>	<input type="checkbox"/>	<input type="checkbox"/>	<input type="checkbox"/>	<input type="checkbox"/>	<input type="checkbox"/>	<input type="checkbox"/>	<input type="checkbox"/>	<input type="checkbox"/>	ETU550	LSI	(N) ²⁾	J	P
		<input type="checkbox"/>	<input type="checkbox"/>	<input type="checkbox"/>	<input type="checkbox"/>	<input type="checkbox"/>	<input type="checkbox"/>	<input type="checkbox"/>	<input type="checkbox"/>	<input type="checkbox"/>	<input type="checkbox"/>	<input type="checkbox"/>	<input type="checkbox"/>	<input type="checkbox"/>	<input type="checkbox"/>	<input type="checkbox"/>	<input type="checkbox"/>	<input type="checkbox"/>	ETU556	LSI(G)	(N) ²⁾	J	T
		<input type="checkbox"/>	<input type="checkbox"/>	<input type="checkbox"/>	<input type="checkbox"/>	<input type="checkbox"/>	<input type="checkbox"/>	<input type="checkbox"/>	<input type="checkbox"/>	<input type="checkbox"/>	<input type="checkbox"/>	<input type="checkbox"/>	<input type="checkbox"/>	<input type="checkbox"/>	<input type="checkbox"/>	<input type="checkbox"/>	<input type="checkbox"/>	<input type="checkbox"/>	ETU560	LSIG	(N) ²⁾	J	Q
	Line protection, with display, with measurement function	<input type="checkbox"/>	<input type="checkbox"/>	<input type="checkbox"/>	<input type="checkbox"/>	<input type="checkbox"/>	<input type="checkbox"/>	<input type="checkbox"/>	<input type="checkbox"/>	<input type="checkbox"/>	<input type="checkbox"/>	<input type="checkbox"/>	<input type="checkbox"/>	<input type="checkbox"/>	<input type="checkbox"/>	<input type="checkbox"/>	<input type="checkbox"/>	<input type="checkbox"/>	ETU820	LI	(N) ²⁾	K	L
		<input type="checkbox"/>	<input type="checkbox"/>	<input type="checkbox"/>	<input type="checkbox"/>	<input type="checkbox"/>	<input type="checkbox"/>	<input type="checkbox"/>	<input type="checkbox"/>	<input type="checkbox"/>	<input type="checkbox"/>	<input type="checkbox"/>	<input type="checkbox"/>	<input type="checkbox"/>	<input type="checkbox"/>	<input type="checkbox"/>	<input type="checkbox"/>	<input type="checkbox"/>	ETU830	LIG	(N) ²⁾	K	M
		<input type="checkbox"/>	<input type="checkbox"/>	<input type="checkbox"/>	<input type="checkbox"/>	<input type="checkbox"/>	<input type="checkbox"/>	<input type="checkbox"/>	<input type="checkbox"/>	<input type="checkbox"/>	<input type="checkbox"/>	<input type="checkbox"/>	<input type="checkbox"/>	<input type="checkbox"/>	<input type="checkbox"/>	<input type="checkbox"/>	<input checked="" type="checkbox"/>	<input checked="" type="checkbox"/>	ETU850	LSI	(N) ²⁾	K	P
		<input type="checkbox"/>	<input type="checkbox"/>	<input type="checkbox"/>	<input type="checkbox"/>	<input type="checkbox"/>	<input type="checkbox"/>	<input type="checkbox"/>	<input type="checkbox"/>	<input type="checkbox"/>	<input type="checkbox"/>	<input type="checkbox"/>	<input type="checkbox"/>	<input type="checkbox"/>	<input type="checkbox"/>	<input type="checkbox"/>	<input checked="" type="checkbox"/>	<input checked="" type="checkbox"/>	ETU856	LSI(G)	(N) ²⁾	K	T
		<input type="checkbox"/>	<input type="checkbox"/>	<input type="checkbox"/>	<input type="checkbox"/>	<input type="checkbox"/>	<input type="checkbox"/>	<input type="checkbox"/>	<input type="checkbox"/>	<input type="checkbox"/>	<input type="checkbox"/>	<input type="checkbox"/>	<input type="checkbox"/>	<input type="checkbox"/>	<input type="checkbox"/>	<input type="checkbox"/>	<input checked="" type="checkbox"/>	<input checked="" type="checkbox"/>	ETU860	LSIG	(N) ²⁾	K	Q
Number of poles	1-pole	<input checked="" type="checkbox"/>	<input type="checkbox"/>	<input type="checkbox"/>	<input type="checkbox"/>	<input type="checkbox"/>	<input type="checkbox"/>	<input type="checkbox"/>	<input type="checkbox"/>	<input type="checkbox"/>	<input type="checkbox"/>	<input type="checkbox"/>	<input type="checkbox"/>	<input type="checkbox"/>	<input type="checkbox"/>	<input type="checkbox"/>	<input type="checkbox"/>	<input type="checkbox"/>	<input type="checkbox"/>	<input type="checkbox"/>	<input type="checkbox"/>	<input type="checkbox"/>	1
	2-pole	<input checked="" type="checkbox"/>	<input type="checkbox"/>	<input type="checkbox"/>	<input type="checkbox"/>	<input type="checkbox"/>	<input type="checkbox"/>	<input type="checkbox"/>	<input type="checkbox"/>	<input type="checkbox"/>	<input type="checkbox"/>	<input type="checkbox"/>	<input type="checkbox"/>	<input type="checkbox"/>	<input type="checkbox"/>	<input type="checkbox"/>	<input type="checkbox"/>	<input type="checkbox"/>	<input type="checkbox"/>	<input type="checkbox"/>	<input type="checkbox"/>	<input type="checkbox"/>	2
	2-pole in 3-pole enclosure	<input type="checkbox"/>	<input checked="" type="checkbox"/>	<input checked="" type="checkbox"/>	<input checked="" type="checkbox"/>	<input checked="" type="checkbox"/>	<input type="checkbox"/>	<input type="checkbox"/>	<input type="checkbox"/>	<input type="checkbox"/>	<input type="checkbox"/>	<input type="checkbox"/>	<input type="checkbox"/>	<input type="checkbox"/>	<input type="checkbox"/>	<input type="checkbox"/>	<input type="checkbox"/>	<input type="checkbox"/>	<input type="checkbox"/>	<input type="checkbox"/>	<input type="checkbox"/>	<input type="checkbox"/>	6
	3-pole	<input checked="" type="checkbox"/>	<input checked="" type="checkbox"/>	<input checked="" type="checkbox"/>	<input checked="" type="checkbox"/>	<input checked="" type="checkbox"/>	<input checked="" type="checkbox"/>	<input checked="" type="checkbox"/>	<input checked="" type="checkbox"/>	<input checked="" type="checkbox"/>	<input checked="" type="checkbox"/>	<input checked="" type="checkbox"/>	<input checked="" type="checkbox"/>	<input checked="" type="checkbox"/>	<input checked="" type="checkbox"/>	<input checked="" type="checkbox"/>	<input checked="" type="checkbox"/>	<input checked="" type="checkbox"/>	<input checked="" type="checkbox"/>	<input checked="" type="checkbox"/>	<input checked="" type="checkbox"/>	<input checked="" type="checkbox"/>	3
	4-pole	<input checked="" type="checkbox"/>	<input checked="" type="checkbox"/>	<input checked="" type="checkbox"/>	<input checked="" type="checkbox"/>	<input checked="" type="checkbox"/>	<input checked="" type="checkbox"/>	<input checked="" type="checkbox"/>	<input checked="" type="checkbox"/>	<input checked="" type="checkbox"/>	<input checked="" type="checkbox"/>	<input checked="" type="checkbox"/>	<input checked="" type="checkbox"/>	<input checked="" type="checkbox"/>	<input checked="" type="checkbox"/>	<input checked="" type="checkbox"/>	<input checked="" type="checkbox"/>	<input checked="" type="checkbox"/>	<input checked="" type="checkbox"/>	<input checked="" type="checkbox"/>	<input checked="" type="checkbox"/>	<input checked="" type="checkbox"/>	4
Connection technology	Without	<input checked="" type="checkbox"/>	<input checked="" type="checkbox"/>	<input checked="" type="checkbox"/>	<input type="checkbox"/>	<input checked="" type="checkbox"/>	<input checked="" type="checkbox"/>	<input checked="" type="checkbox"/>	<input checked="" type="checkbox"/>	<input type="checkbox"/>	<input type="checkbox"/>	<input type="checkbox"/>	<input type="checkbox"/>	<input type="checkbox"/>	<input checked="" type="checkbox"/>	<input checked="" type="checkbox"/>	<input checked="" type="checkbox"/>	<input type="checkbox"/>	<input type="checkbox"/>	<input type="checkbox"/>	<input type="checkbox"/>	<input type="checkbox"/>	1
	Nut keeper kit	<input type="checkbox"/>	<input type="checkbox"/>	<input type="checkbox"/>	<input checked="" type="checkbox"/>	<input type="checkbox"/>	<input type="checkbox"/>	<input type="checkbox"/>	<input type="checkbox"/>	<input type="checkbox"/>	<input type="checkbox"/>	<input type="checkbox"/>	<input type="checkbox"/>	<input type="checkbox"/>	<input type="checkbox"/>	<input type="checkbox"/>	<input type="checkbox"/>	<input type="checkbox"/>	<input type="checkbox"/>	<input type="checkbox"/>	<input type="checkbox"/>	<input type="checkbox"/>	2
Special applications	Standard	<input checked="" type="checkbox"/>	<input checked="" type="checkbox"/>	<input checked="" type="checkbox"/>	<input checked="" type="checkbox"/>	<input checked="" type="checkbox"/>	<input checked="" type="checkbox"/>	<input checked="" type="checkbox"/>	<input checked="" type="checkbox"/>	<input checked="" type="checkbox"/>	<input checked="" type="checkbox"/>	<input checked="" type="checkbox"/>	<input checked="" type="checkbox"/>	<input checked="" type="checkbox"/>	<input checked="" type="checkbox"/>	<input checked="" type="checkbox"/>	<input checked="" type="checkbox"/>	<input checked="" type="checkbox"/>	<input checked="" type="checkbox"/>	<input checked="" type="checkbox"/>	<input checked="" type="checkbox"/>	<input checked="" type="checkbox"/>	0
	100% rated breaker	<input type="checkbox"/>	<input type="checkbox"/>	<input type="checkbox"/>	<input type="checkbox"/>	<input checked="" type="checkbox"/>	<input checked="" type="checkbox"/>	<input type="checkbox"/>	<input checked="" type="checkbox"/>	<input checked="" type="checkbox"/>	<input checked="" type="checkbox"/>	<input checked="" type="checkbox"/>	<input checked="" type="checkbox"/>	<input checked="" type="checkbox"/>	<input checked="" type="checkbox"/>	<input checked="" type="checkbox"/>	<input checked="" type="checkbox"/>	<input checked="" type="checkbox"/>	<input checked="" type="checkbox"/>	<input checked="" type="checkbox"/>	<input checked="" type="checkbox"/>	<input checked="" type="checkbox"/>	2

¹⁾ Only possible for 250 A

²⁾ Only possible for 400 A

Structure of the article numbers

Basic configuration for motor circuit protectors and molded case switches

The structure shown below is intended as an overview of each position and its meaning. For a complete and valid configuration of your molded case circuit breaker, please use our online configurator at www.siemens.com/lowvoltage/3va-ul-configurator

2

		3VA		4	5	6	7	8	9	10	11	12	- 0AA0				
Trip units		Thermal-magnetic		5													
		Electronic		6													
			3VA51	3VA52	3VA53	3VA54	3VA55	3VA57	3VA58	3VA59	3VA61	3VA62	3VA63	3VA64	3VA65		
Size	125 A	■	-	-	-	-	-	-	-	-	-	-	-	-	-	1	
	150 A	-	-	-	-	-	-	-	-	-	■	-	-	-	-	1	
	250 A	-	■	-	-	-	-	-	-	-	■	-	-	-	-	2	
	400 A	-	-	■	-	-	-	-	-	-	-	■	-	-	-	3	
	600 A	-	-	-	■	-	-	-	-	-	-	-	■	-	-	4	
	800 A	-	-	-	-	■	-	-	-	-	-	-	-	■	-	5	
	1200 A	-	-	-	-	-	■	-	-	-	-	-	-	-	-	7	
	1600 A	-	-	-	-	-	-	■	-	-	-	-	-	-	-	8	
	2000 A	-	-	-	-	-	-	-	■	-	-	-	-	-	-	9	
Max. rated current I_n	Motor circuit protector	1 A	■	-	-	-	-	-	-	-	-	-	-	-	-	8	1
		2 A	■	-	-	-	-	-	-	-	-	-	-	-	-	-	0
		3 A	■	-	-	-	-	-	-	-	-	-	-	-	-	0	3
		5 A	■	-	-	-	-	-	-	-	-	-	-	-	-	0	5
		7 A	■	-	-	-	-	-	-	-	-	-	-	-	-	0	7
		10 A	■	-	-	-	-	-	-	-	-	-	-	-	-	9	1
		15 A	■	-	-	-	-	-	-	-	-	-	-	-	-	9	5
		25 A	■	-	-	-	-	-	-	-	-	-	-	-	-	2	5
		30 A	■	-	-	-	-	-	-	■	-	-	-	-	-	3	0
		40 A	■	-	-	-	-	-	-	-	■	-	-	-	-	4	0
		50 A	■	-	-	-	-	-	-	-	■	-	-	-	-	5	0
		70 A	■	-	-	-	-	-	-	-	■	-	-	-	-	7	0
		80 A	■	-	-	-	-	-	-	-	■	-	-	-	-	8	0
		90 A	■	-	-	-	-	-	-	-	■	-	-	-	-	9	0
		100 A	■	-	-	-	-	-	-	-	-	■	-	-	-	1	0
		110 A	■	-	-	-	-	-	-	-	-	■	-	-	-	1	1
		125 A	■	-	-	-	-	-	-	-	-	■	-	-	-	1	2
		150 A	-	■	-	-	-	-	-	-	-	■	-	-	-	1	5
		200 A	-	■	-	-	-	-	-	-	-	■	-	-	-	2	0
		250 A	-	■	■	-	-	-	-	-	-	■	-	-	-	2	5
		400 A	-	-	■	-	-	-	-	-	-	■	■	-	-	4	0
		500 A	-	-	-	■	-	-	-	-	-	■	-	-	-	5	0
		600 A	-	-	-	■	■	-	-	-	-	■	-	-	-	6	0
		800 A	-	-	-	-	■	-	-	-	-	■	-	■	-	8	0
	Molded case switch	100 A	■	■	-	-	-	-	-	-	-	-	-	-	-	1	0
		150 A	-	■	-	-	-	-	-	-	-	-	-	-	-	1	5
		250 A	-	■	-	-	-	-	-	-	-	-	-	-	-	2	5
		400 A	-	-	■	-	-	-	-	-	-	-	-	-	-	4	0
		600 A	-	-	-	■	-	-	-	-	-	-	-	-	-	6	0
		800 A	-	-	-	-	■	-	-	-	-	-	-	-	-	8	0
		1000 A	-	-	-	-	-	■	-	-	-	-	-	-	-	1	0
		1200 A	-	-	-	-	-	-	■	-	-	-	-	-	-	1	2
		1600 A	-	-	-	-	-	■	-	-	-	-	-	-	1	6	
		2000 A	-	-	-	-	-	-	■	-	-	-	-	-	2	0	
Short-circuit breaking capacity at 480 V 50/60 Hz	Without, with SCCR rating as a combined device	65 kA	-	■	■	■	■	-	-	-	-	-	-	-	-	0	1
		100 kA	-	■	■	■	■	■	■	-	-	-	-	-	-	6	1
			-	■	■	■	■	■	■	■	■	■	■	■	■	1	7

■ Available - Not available/not present

		3VA 4 5 6 7 8 9 10 11 12 - 0AA0																
		3VA51	3VA52	3VA53	3VA54	3VA55	3VA57	3VA58	3VA59	3VA61	3VA62	3VA63	3VA64	3VA65				
Protective function thermal-magnetic	Motor circuit protector	Setting range I _n high	■	■	■	■	-	-	-	-	-	-	-	-	TM120M	AM	M	H
		Setting range I _n low	■	■	■	-	-	-	-	-	-	-	-	-	TM120M	AM	M	U
Protective function only intrinsic device protection	Molded case switch		■	■	■	■	■	■	-	-	-	-	-	MCS110	-	B	B	
Protective function electronic	Motor circuit protector		-	-	-	-	-	-	-	■	■	■	■	ETU310M I		M	S	
Number of poles	Motor circuit protector		■	■	■	■	-	-	-	■	■	■	■	3-pole				3
	Molded case switch		■	-	-	-	-	-	-	-	-	-	-	2-pole				2
			-	■	■	■	■	■	-	-	-	-	-	2-pole in 3-pole enclosure				6
			■	■	■	■	■	■	-	-	-	-	-	3-pole				3
			-	■	-	-	-	-	-	-	-	-	-	4-pole				4
Connection technology	Without		■	■	■	-	■	■	■	■	■	■	-					1
	Nut keeper kit		-	-	-	■	-	-	-	-	-	-	■					2

Internal accessories

Auxiliary and alarm switches (changeover contacts)

For a complete and valid configuration of your molded case circuit breaker, please use our online configurator at www.siemens.com/lowvoltage/3va-ul-configurator

2

				3VA61		
3VA51				3VA62		
3VA52				3VA63		
3VA53				3VA64	3VA57	3VA67
3VA54				3VA65	3VA58	3VA68
3VA55				3VA66	3VA59	3VA69

Auxiliary switches AUX

- Used to signal the position of the main contacts of the molded case circuit breaker
- The contacts of the auxiliary switch and the molded case circuit breaker close in unison



Type	Width	I_e	U_e AC/DC	Version		
HQ	7 mm (1 slot)	6 A	240 V/250 V	Standard	3VA9978-0AA12	
		0.3 A	24 V/24 V	Electronic-compatible	3VA9978-0AA13	
HP	14 mm (2 slots)	10 A	600 V/250 V	Standard	3VA9978-0AA11	

Leading changeover switches LCS

- Used for load shedding, for example
- Signal the opening of the main contacts with a lead time of 20 ms in advance of circuit breaker trips



Type	Width	I_e	U_e AC/DC	Version		
HQ	7 mm (1 slot)	6 A	240 V/250 V	Standard	3VA9978-0AA22	–
		0.3 A	24 V/24 V	Electronic-compatible	3VA9978-0AA23	–
HP	14 mm (2 slots)	10 A	600 V/250 V	Standard	3VA9978-0AA21	–

Trip alarm switches TAS

- Signal every circuit breaker tripping operation
- Are actuated whenever the molded case circuit breaker switches to the TRIP position



Type	Width	I_e	U_e AC/DC	Version		
HQ	7 mm (1 slot)	6 A	240 V/250 V	Standard	3VA9978-0AB12	
		0.3 A	24 V/24 V	Electronic-compatible	3VA9978-0AB13	
HP	14 mm (2 slots)	10 A	600 V/250 V	Standard	3VA9978-0AB11	

Electrical alarm switches EAS

- Are actuated as soon as the main contacts of the molded case circuit breaker open in the event that the breaker is tripped by the ETU



Type	Width	I_e	U_e AC/DC	Version				
HQ	7 mm (1 slot)	6 A	240 V/250 V	Standard	–	3VA9978-0AB22	–	Already integrated
		0.3 A	24 V/24 V	Electronic-compatible	–	3VA9978-0AB23	–	Already integrated

Auxiliary releases

For a complete and valid configuration of your molded case circuit breaker, please use our online configurator at www.siemens.com/lowvoltage/3va-ul-configurator

			3VA57
			3VA58
			3VA59
			3VA65
	3VA51		3VA66
	3VA52	3VA61	3VA67
	3VA53	3VA62	3VA68
	3VA54	3VA63	3VA69
	3VA55	3VA64	

2

Shunt trips left STL



- Used for remote-controlled tripping of the molded case circuit breaker
- Have particularly low power consumption

Version	U_e 50/60 Hz AC	U_e DC	
Standard	–	12 V	3VA9978-OBL10
	24 V	24 ... 30 V	3VA9978-OBL30
	48 ... 60 V	48 ... 60 V	3VA9978-OBL31
	110 ... 127 V	110 ... 127 V	3VA9978-OBL32
	208 ... 277 V	220 ... 250 V	3VA9978-OBL33
	380 ... 600 V	–	3VA9978-OBL20

Shunt trips flexible STF



- Used for remote-controlled tripping of the molded case circuit breaker
- Can be flexibly installed in left-hand and right-hand accessories compartment of molded case circuit breaker

Version	U_e 50/60 Hz AC	U_e DC		
	24 V	–	–	3VA9978-OBA20
	48 ... 60 V	–	–	3VA9978-OBA21
	110 ... 127 V	–	–	3VA9978-OBA22
	208 ... 277 V	–	–	3VA9978-OBA23
	380 ... 500 V	–	–	3VA9978-OBA24
	600 V	–	–	3VA9978-OBA25

Universal releases UNI



- Combination of shunt trip and undervoltage release

Version	U_e 50/60 Hz AC	U_e DC	
	–	12 V	3VA9978-OBD11
	–	24 V	3VA9978-OBD12
	–	48 V	3VA9978-OBD13

Undervoltage releases UVR



- Trip the molded case circuit breaker in the event that the rated operational voltage of a monitored circuit drops below a minimum permissible limit or fails altogether

Version	U_e 50/60 Hz AC	U_e DC	
	–	12 V	3VA9978-0BB10
	–	24 V	3VA9978-0BB11
	24 V	–	3VA9978-0BB20
	–	48 V	3VA9978-0BB12
	120 ... 127 V	–	3VA9978-0BB24
	–	125 ... 127 V	3VA9978-0BB14
	208 ... 230 V	–	3VA9978-0BB25
	–	250 V	3VA9978-0BB16
	440 ... 480 V	–	3VA9978-0BB27

Time-delay devices for undervoltage releases



Version	U_e 50/60 Hz AC	U_e DC	
	230 V	230 V	3VA9978-0BF22
	–	24 V	3VA9978-0BF23

Manual operators

For a complete and valid configuration of your molded case circuit breaker, please use our online configurator at www.siemens.com/lowvoltage/3va-ul-configurator

2

						3VA53
						3VA52
						3VA54
					3VA61	3VA63
				3VA51	3VA62	3VA64

Front mounted rotary operators

- Handle
- Degree of protection IP30
- For 3-pole and 4-pole breakers

Version	Door open function	Illumination kit	Door interlock			
Standard (gray)	Without	Without	Without	3VA9137-0EK11	3VA9277-0EK11	3VA9447-0EK11
			With	3VA9137-0EK21	3VA9277-0EK21	3VA9447-0EK21
		With	Without	3VA9137-0EK13	3VA9277-0EK13	3VA9447-0EK13
			With	3VA9137-0EK23	3VA9277-0EK23	3VA9447-0EK23
	With	Without	With	3VA9137-0EK31	3VA9277-0EK31	3VA9447-0EK31
			With	3VA9137-0EK33	3VA9277-0EK33	3VA9447-0EK33
		Without	Without	3VA9137-0EK15	3VA9277-0EK15	3VA9447-0EK15
			With	3VA9137-0EK25	3VA9277-0EK25	3VA9447-0EK25
EMERGENCY-OFF (red/yellow)	Without	With	Without	3VA9137-0EK17	3VA9277-0EK17	3VA9447-0EK17
			With	3VA9137-0EK27	3VA9277-0EK27	3VA9447-0EK27
	With	Without	3VA9137-0EK35	3VA9277-0EK35	3VA9447-0EK35	
		With	3VA9137-0EK37	3VA9277-0EK37	3VA9447-0EK37	

Door mounted rotary operator

- Shaft 300 mm (325 mm for 1000 A)
- With mounting tolerance compensation
- Handle with masking plate 75 x 75 mm
- Degree of protection IP65
- For 3-pole and 4-pole breakers
- Enclosure types 1, 3R, 12, 4/4X







Version	Door open function	Illumination kit	Door interlock			
Standard (gray)	Without	Without	With	3VA9137-0FK21	3VA9277-0FK21	3VA9447-0FK21
			With	3VA9137-0FK23	3VA9277-0FK23	3VA9447-0FK23
	With	Without	3VA9137-0FK31	3VA9277-0FK31	3VA9447-0FK31	
		With	3VA9137-0FK33	3VA9277-0FK33	3VA9447-0FK33	
EMERGENCY-OFF (red/yellow)	Without	With	With	3VA9137-0FK25	3VA9277-0FK25	3VA9447-0FK25
			With	3VA9137-0FK27	3VA9277-0FK27	3VA9447-0FK27
	With	Without	3VA9137-0FK35	3VA9277-0FK35	3VA9447-0FK35	
		With	3VA9137-0FK37	3VA9277-0FK37	3VA9447-0FK37	

	3VA57
	3VA58
	3VA59
3VA55	3VA67
3VA65	3VA68
3VA66	3VA69
3VA9677-0EK11	3VA9877-0EK11 new
3VA9677-0EK21	–
–	–
–	–
3VA9677-0EK31	–
–	–
3VA9677-0EK15	3VA9877-0EK15 new
3VA9677-0EK25	–
–	–
–	–
3VA9677-0EK35	–
–	–
3VA9677-0FK21	3VA9877-0FK21 new
3VA9677-0FK23	–
3VA9677-0FK31	–
3VA9677-0FK33	–
3VA9677-0FK25	3VA9877-0FK25 new
3VA9677-0FK27	–
3VA9677-0FK35	–
3VA9677-0FK37	–

Manual operators

For a complete and valid configuration of your molded case circuit breaker, please use our online configurator at www.siemens.com/lowvoltage/3va-ul-configurator

2

					3VA51	3VA62	3VA61	3VA52	3VA53	3VA54
Door mounted rotary operators without handle										
<ul style="list-style-type: none"> Degree of protection IP30 For 3-pole and 4-pole breakers 										
	Version	Door open function	Illumination kit	Door interlock						
	With shaft stub (gray)	Without	Without	Without	3VA9137-0GK00	3VA9277-0GK00	3VA9447-0GK00			
	With shaft stub (gray)	Without	Without	Without	–	–	–			
Side wall mounted rotary operators without mounting plates										
<ul style="list-style-type: none"> Rotary operator with shaft 300 mm Handle with masking plate 75 × 75 mm Degree of protection IP65 For 3-pole and 4-pole breakers 										
	Version	Illumination kit								
	Standard (gray)	Without	With		3VA9137-0PK11	3VA9277-0PK11	–			
					3VA9137-0PK13	3VA9277-0PK13	–			
	EMERGENCY-OFF (red/yellow)	Without	With		3VA9137-0PK15	3VA9277-0PK15	–			
					3VA9137-0PK17	3VA9277-0PK17	–			
Side wall mounted rotary operators with mounting plates										
<ul style="list-style-type: none"> Rotary operator with short shaft and mounting plate for mounting directly on the side wall Handle with masking plate 75 × 75 mm Degree of protection IP65 For 3-pole and 4-pole breakers 										
	Version	Illumination kit								
	Standard (gray)	Without	With		3VA9137-0PK51	3VA9277-0PK51	–			
					3VA9137-0PK53	3VA9277-0PK53	–			
	EMERGENCY-OFF (red/yellow)	Without	With		3VA9137-0PK55	3VA9277-0PK55	–			
					3VA9137-0PK57	3VA9277-0PK57	–			
Door interlock for side wall mounted rotary operators										
					3VA9177-0VF40	3VA9277-0VF40	–			
Extended DIN rails for N/PE terminals										
	Version	Rated current I_n								
	For mounting plate				≤250 A			3VA9987-OGL30		

	3VA57
	3VA58
	3VA59
3VA55	3VA67
3VA65	3VA68
3VA66	3VA69
3VA9677-0GK00	
-	3VA9877-0GK00 new
-	-
-	-
-	-
-	-
-	-
-	-
-	-
-	-
-	-
-	-

Manual operators

For a complete and valid configuration of your molded case circuit breaker, please use our online configurator at www.siemens.com/lowvoltage/3va-ul-configurator

2

			3VA53
		3VA52	3VA54
		3VA61	3VA63
	3VA51	3VA62	3VA64

Supplementary handles for door mounted rotary operators (NFPA79)

- Mandatory according to NFPA79
- For operation when cabinet door is open

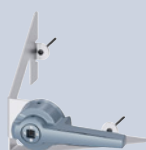

Version	3VA51	3VA62	3VA63
Standard (gray)	3VA9137-0GC01	3VA9477-0GC01	3VA9477-0GC11
EMERGENCY-OFF (red/yellow)	3VA9137-0GC05	3VA9477-0GC05	3VA9477-0GC15
Standard (gray)	-	-	-
EMERGENCY-OFF (red/yellow)	-	-	-

Handles

- With masking plate



Version	Door open function	Tolerance compensation	3VA51	3VA62	3VA63
Standard (gray)	Without	Without	8UD1721-0AB11	8UD1731-0AB11	8UD1731-0AB11
		With	8UD1721-0AB21	8UD1731-0AB21	8UD1731-0AB21
	With	Without	8UD1721-0AC11	8UD1731-0AC11	8UD1731-0AC11
		With	8UD1721-0AC21	8UD1731-0AC21	8UD1731-0AC21
EMERGENCY-OFF (red/yellow)	Without	Without	8UD1721-0AB15	8UD1731-0AB15	8UD1731-0AB15
		With	8UD1721-0AB25	8UD1731-0AB25	8UD1731-0AB25
	With	Without	8UD1721-0AC15	8UD1731-0AC15	8UD1731-0AC15
		With	8UD1721-0AC25	8UD1731-0AC25	8UD1731-0AC25

Handle lever extensions

- **Note:** The handle lever extension is already included in the scope of supply of the breakers.



					3VA9487-0SC10
--	--	--	--	--	---------------

Shafts



Type	Length	3VA51	3VA62	3VA63
8 × 8 mm	300 mm		8UD1900-2WA00	
	600 mm		8UD1900-2WB00	
12 × 12 mm	305 mm		-	
	325 mm		-	
	600 mm		-	
	610 mm		-	

Adapters for shafts



Type	Use	3VA51	3VA62	3VA63
8 × 8 mm	With door mounted rotary operator and side wall mounted rotary operator		8UD1900-2DA00	
12 × 12 mm	With door mounted rotary operator and side wall mounted rotary operator		-	

Door couplings



Type	3VA51	3VA62	3VA63
8 × 8 mm			8UD1900-2HA00
12 × 12 mm			-

Mounting tolerance compensations











Type	3VA51	3VA62	3VA63
8 × 8 mm			8UD1900-2GA00
12 × 12 mm			-

	3VA57
	3VA58
	3VA59
3VA55	3VA67
3VA65	3VA68
3VA66	3VA69
3VA9677-0GC01	–
3VA9677-0GC05	–
–	3VA9877-0GC01 new
–	3VA9877-0GC05 new
8UD1741-0AB11	
8UD1741-0AB21	
8UD1741-0AC11	
8UD1741-0AC21	
8UD1741-0AB15	
8UD1741-0AB25	
8UD1741-0AC15	
8UD1741-0AC25	
3VA9987-0SC10	3VA9877-0SC10 new
–	–
–	–
–	–
8UD1900-4WA00	–
8UD1900-4WB00	–
–	–
–	–
8UD1900-4DA00	
–	–
8UD1900-4HA00	
–	–
8UD1900-4GA00	

Manual operators

For a complete and valid configuration of your molded case circuit breaker, please use our online configurator at www.siemens.com/lowvoltage/3va-ul-configurator

2







		3VA51	3VA52	3VA53	3VA54	3VA61	3VA62	3VA63	3VA64
Fixing brackets for shafts									
		3VA9137-0GA80	3VA9477-0GA80						
		-	-	-					
Variable depth adapters									
	Type								
	8 × 8 mm	3VA9487-0GB10							
Interlocking module UL 508A									
	<ul style="list-style-type: none"> Used when the handle is to remain on the circuit breaker when the door is open 								
		8UC9400							
Labeling plates for manual operators									
		3VA9087-0SX10							
Illumination kits for manual operators									
	<ul style="list-style-type: none"> 24 V DC voltage 								
	Version	Rated current I_n							
	Front mounted rotary operator	125 ... 250 A	8UD1900-0KA10		-		8UD1900-0KA20		
		150 ... 600 A	-						
	Door mounted rotary operator and side wall mounted rotary operator	125 ... 600 A	8UD1900-0KA20						
		600 ... 1000A	-		-		-		
Cylinder locks (type Kaba), standard masking plates									
	Use	Door open function	Key						
	For door mounted rotary operator and side wall mounted rotary operator (in the masking plate), only for locking, not for interlocking	Without	1	8UD1900-0MB01					
			2	8UD1900-0NB01					
			3	8UD1900-0PB01					
			4	8UD1900-0QB01					
		With	1	8UD1900-0MC01					
			2	8UD1900-0NC01					
			3	8UD1900-0PC01					
			4	8UD1900-0QC01					
Cylinder locks (type KABA), EMERGENCY-OFF masking plates									
	Use	Door open function	Key						
	For door mounted rotary operator and side wall mounted rotary operator (in the masking plate), only for locking, not for interlocking	Without	1	8UD1900-0MB05					
			2	8UD1900-0NB05					
			3	8UD1900-0PB05					
			4	8UD1900-0QB05					
		With	1	8UD1900-0MC05					
			2	8UD1900-0NC05					
			3	8UD1900-0PC05					
			4	8UD1900-0QC05					

	3VA57
	3VA58
	3VA59
3VA55	3VA67
3VA65	3VA68
3VA66	3VA69
–	–
3VA9677-0GA80	3VA9877-0GA80 new
–	–
–	–
–	–
–	–
–	–
–	–
–	–
–	–
8UD1900-0KA30	–
–	–
–	–
–	–
–	–
–	–
–	–
–	–
–	–
–	–
–	–
–	–
–	–
–	–

Manual operators

For a complete and valid configuration of your molded case circuit breaker, please use our online configurator at www.siemens.com/lowvoltage/3va-ul-configurator

2

	3VA51	3VA62	3VA63	3VA64	3VA52	3VA53	3VA54
Cylinder locks (type RONIS)							
	<ul style="list-style-type: none"> Includes a lock with 2 keys For locking or interlocking For installation on the circuit breaker side in all rotary operators For mounting in the adapter kit for the accessories compartment Note: The cylinder lock adapter for rotary operators is also needed for locking or interlocking circuit breakers via rotary operators 						
Key							
1							3VA9980-0VL10
3							3VA9980-0VL30
4							3VA9980-0VL40
Cylinder locks (type RONIS), for 3VA9877-0EK1. front mounted rotary operators and 3VA877-0FK2. door mounted rotary operators							
	<ul style="list-style-type: none"> Includes a lock with 2 keys For locking For installation on the circuit breaker side in all rotary operators 						
							-
Cylinder lock adapters for rotary operators							
	<ul style="list-style-type: none"> To mount the cylinder lock in the rotary operator (also possible with door mounted rotary operator and side wall mounted rotary operator), on circuit breaker side, NOT in masking plate 						
							3VA9980-0LF20
Auxiliary switch modules for rotary operators							
	Version						
1× leading to „ON“		-			-		-
2× leading to „ON“	3VA9137-0GX10					3VA9477-0GX10	
1× leading to „OFF“		-			-		-
2× leading to „OFF“		-			-		-
2× leading to „ON“ and 1× leading to „OFF“		-				3VA9477-0GX20	
Mounting adapters for side wall mounted rotary operators							
	Version						
Necessary accessories for 3VA side wall mounted rotary operators, if 3VA9...-0GX.0 auxiliary switch modules are used	3VA9137-0GX01					3VA9477-0GX01	
Auxiliary switches for 3VA9877-0EK1. front mounted rotary operators and 3VA9877-0FK2. door mounted rotary operators							
	Version						
1× leading to „ON“		-			-		-
2× leading to „ON“		-			-		-
1× leading to „OFF“		-			-		-
2× leading to „OFF“		-			-		-
Operating units with Bowden cable (MaxFlex operator), plastic							
	<ul style="list-style-type: none"> Complete set, comprising: <ul style="list-style-type: none"> Switching mechanism Handle, plastic Enclosure types 1, 3, 3R, 4, 12, 12K, black = OFF, red = ON Bowden cable, length 36 inch (0.9 m) 						
		3VA9137-0CK12			3VA9277-0CK12		3VA9477-0CK12

	3VA57
	3VA58
	3VA59
3VA55	3VA67
3VA65	3VA68
3VA66	3VA69
3VA9980-0VL10	–
3VA9980-0VL30	–
3VA9980-0VL40	–
–	3VA9870-0VL10 new
3VA9670-0LF20	–
–	–
–	–
–	–
–	–
–	–
–	–
–	3VA9877-0GX31 new
–	3VA9877-0GX32 new
–	3VA9877-0GX41 new
–	3VA9877-0GX42 new
–	–

Manual operators

For a complete and valid configuration of your molded case circuit breaker, please use our online configurator at www.siemens.com/lowvoltage/3va-ul-configurator

2

			3VA53
		3VA52	3VA54
		3VA61	3VA63
	3VA51	3VA62	3VA64

Operating units with Bowden cable (MaxFlex operator), steel



- Complete set, comprising:
 - Switching mechanism
 - Handle, steel, epoxy-coated
 - Enclosure types 1, 3, 3R, 4, 12, 12K, black = OFF, red = ON
 - Bowden cable, length 36 inch (0.9 m)

	3VA9137-0CK72	3VA9277-0CK72	3VA9477-0CK72
--	---------------	---------------	---------------

Switching mechanisms for operating unit with Bowden cable



	3VA9137-0CB10	3VA9277-0CB10	3VA9477-0CB10
--	---------------	---------------	---------------

Handles for operating unit with Bowden cable



Handle	Enclosure types	OFF	ON	
Plastic	1, 3, 3R, 4, 12, 12K	Black	Red	3VA9977-0CH12
Steel, epoxy-coated	1, 3, 3R, 4, 12, 12K	Black	Red	3VA9977-0CH72
		Black	Black	3VA9977-0CH74
Stainless steel, chrome-plated	1, 2, 3, 3R, 4, 4X, 12, 12K, 13	Black	Red	3VA9977-0CH82
		Black	Black	3VA9977-0CH84

Bowden cables for operating unit with Bowden cable



Length		
36 inch (0.9 m)	3VA9278-0CC10	3VA9578-0CC10
48 inch (1.2 m)	3VA9278-0CC20	3VA9578-0CC20
60 inch (1.5 m)	3VA9278-0CC30	3VA9578-0CC30
72 inch (1.8 m)	3VA9278-0CC40	3VA9578-0CC40
84 inch (2.1 m)	3VA9278-0CC50	3VA9578-0CC50
96 inch (2.4 m)	3VA9278-0CC60	3VA9578-0CC60
120 inch (3.0 m)	3VA9278-0CC70	3VA9578-0CC70
144 inch (3.6 m)	3VA9278-0CC80	3VA9578-0CC80

Auxiliary switches for operating unit with Bowden cable



- Leading from On to Off

Types	
1 CO	3VA9478-0CX10
2 CO	3VA9478-0CX20

Operating units with linkage



- Complete set, comprising:
 - Switching mechanism
 - Handle
- For mounting depths 200 ... 400 mm

Handle	ON			
Steel, epoxy-coated	Red	3VA9138-ODK72	3VA9278-ODK72	3VA9478-ODK72
Steel, chrome-plated	Red	3VA9138-ODK82	3VA9278-ODK82	3VA9478-ODK82
	Black	3VA9138-ODK84	3VA9278-ODK84	3VA9478-ODK84

	3VA57
	3VA58
	3VA59
3VA55	3VA67
3VA65	3VA68
3VA66	3VA69
3VA9677-0CK72	–
3VA9677-0CB10	–
–	–
3VA9877-0CH72	–
3VA9877-0CH74	–
3VA9877-0CH82	–
–	–
–	–
3VA9877-0CC20	–
3VA9877-0CC30	–
3VA9877-0CC40	–
–	–
3VA9877-0CC60	–
3VA9877-0CC70	–
3VA9877-0CC80	–
–	–
–	–
–	–
–	–
–	–

Motor operators

For a complete and valid configuration of your molded case circuit breaker, please use our online configurator at www.siemens.com/lowvoltage/3va-ul-configurator

2

Motor operators without stored energy operators (MO320)

	Addressable via control signals	Isolating features in accordance with IEC/EN 60947-1	Make time, typically		Break time, typically		Rated operational power
			for 3VA5	for 3VA6	for 3VA5	for 3VA6	
	■	■	800 ... 1700 ms	1000 ... 1700 ms	800 ... 1400 ms	800 ... 1400 ms	250 W, max. 500 W (60 ms)

Motor operators with stored energy operators (SEO520)

	Addressable via control signals	Isolating features in accordance with IEC/EN 60947-1	Make time, typically		Break time, typically		Rated operational power
			for 3VA5	for 3VA6	for 3VA5	for 3VA6	
	■	■	< 80 ms	< 80 ms	< 80 ms	< 80 ms	300 W, max. 500 W (60 ms)

Mechanical operating cycles counters (for installation in the SEO520)

	Mounting		Article No.
		For installation in the SEO520	

Cylinder lock adapters for SEO520

	Mounting		Article No.
		For installation of cylinder locks in the SEO520	

Cylinder locks (type RONIS)

	Key		Article No.
		<ul style="list-style-type: none"> Includes a lock with 2 keys For locking the operating mode (Manual/Auto/Lock) 	
	1		3VA9980-0VL10
	3		3VA9980-0VL30
	4		3VA9980-0VL40

		3VA51	3VA52 3VA61 3VA62	3VA53 3VA54	3VA63 3VA64
Rated control supply voltage	With communication				
24 ... 60 V DC	–	3VA9137-0HA10	3VA9277-0HA10	3VA9447-0HA10	
110 ... 230 V AC/ 110 ... 250 V DC	–	3VA9137-0HA20	3VA9277-0HA20	3VA9447-0HA20	
Rated control supply voltage	With communication				
24 V DC	–	–	3VA9277-0HC10	3VA9447-0HC10 ¹⁾ new	
42 ... 60 V AC/DC	–	–	3VA9277-0HC20	3VA9447-0HC20 ¹⁾ new	
110 ... 230 V AC/ 110 ... 250 V DC	–	–	3VA9277-0HC30	3VA9447-0HC30 ¹⁾ new	
24 V DC	Yes	–	3VA9277-0HC15	–	3VA9447-0HC15 ¹⁾ new
110 ... 230 V AC/ 110 ... 250 V DC	Yes	–	3VA9277-0HC35	–	3VA9447-0HC35 ¹⁾ new

¹⁾ For 3VA53 and 3VA54 (UL/IEC) product versions < *E04* as well as for 3VA63 and 3VA64 (UL/IEC) product versions < *E03*, the SE0520 cannot be used. It may be necessary to upgrade to a circuit breaker with a higher product version.



Reset mode

All motor operators have the following reset modes:

- Reset mode 1: Automatic reset
- Reset mode 2: Reset via OFF-signal

The motor operator with SE0520 stored energy operator additionally has:

- Reset mode 3: Reset via OFF-signal with additional acknowledge signal

Connection technology



1 For mounting onto the circuit breaker



2 For mounting on plug-in and withdrawable units





3 Mounting base

For a complete and valid configuration of your molded case circuit breaker, please use our online configurator at www.siemens.com/lowvoltage/3va-ul-configurator

2



Box terminals

	Number of poles	Connection options	Scope of supply	Cable cross-section, Cu stranded, class B	
				Min.	Max.
	3P	1 2 –	3 single terminals	AWG 14	3/0
				AWG 10	3/0
				AWG 4	350 kcmil
				1/0	500 kcmil
	4P	1 2 –	4 single terminals	AWG 14	3/0
				AWG 10	3/0
				AWG 4	350 kcmil
				1/0	500 kcmil

Box terminal with control wire tap

	Number of poles	Connection options	Scope of supply	Cable cross-section, Cu stranded, class B	
				Min.	Max.
	3P	1 2 –	3 single terminals	AWG 10	3/0
				AWG 4	350 kcmil
				1/0	500 kcmil
	4P	1 2 –	4 single terminals	AWG 10	3/0
				AWG 4	350 kcmil
				1/0	500 kcmil

Nut keeper kits

	Number of poles	Connection options	Scope of supply	Max. tap width		Max. tap thickness
	3P	1 2 –	3 terminals	17 mm	0.66 inch	6.5 mm
				25 mm	0.98 inch	8 mm
				35 mm	1.37 inch	10 mm
				50 mm	1.96 inch	28 mm
	4P	1 2 –	4 terminals	17 mm	0.66 inch	6.5 mm
				25 mm	0.98 inch	8 mm
				35 mm	1.37 inch	10 mm
				50 mm	1.96 inch	28 mm

Nut keeper kits, with inch thread

	Number of poles	Connection options	Scope of supply	Max. tap width	Max. tap thickness
	3P	1 2 –	3 terminals	50.8 mm 2.0 inch	0.6" ... 0.8"/15 ... 20 mm

Nut keeper kits, with metric thread

	Number of poles	Connection options	Scope of supply	Max. tap width	Max. tap thickness
	3P	1 2 –	3 terminals	50 mm 1.96 inch	0.6" ... 0.8"/15 ... 20 mm

¹⁾ Maximum current-carrying capacity of cable connection 400 A
Flexible copper bar: No restrictions

			3VA53					
			3VA54	3VA55				
	3VA51	3VA52	3VA61	3VA63	3VA65	3VA57	3VA58	3VA59
			3VA62	3VA64	3VA66	3VA67	3VA68	3VA69
3VA9133-0JA11	–	–	–	–	–	–	–	–
–	3VA9233-0JA11	3VA9143-0JA12	–	–	–	–	–	–
–	3VA9233-0JA12	3VA9243-0JA12	–	–	–	–	–	–
–	–	–	3VA9473-0JA13 ¹⁾	–	–	–	–	–
3VA9134-0JA11	–	–	–	–	–	–	–	–
–	3VA9234-0JA11	3VA9144-0JA12	–	–	–	–	–	–
–	3VA9234-0JA12	3VA9244-0JA12	–	–	–	–	–	–
–	–	–	3VA9474-0JA13 ¹⁾	–	–	–	–	–
–	3VA9233-0JH11	3VA9143-0JH12	–	–	–	–	–	–
–	3VA9233-0JH12	3VA9243-0JH12	–	–	–	–	–	–
–	–	–	3VA9473-0JH13	–	–	–	–	–
–	3VA9234-0JH11	3VA9144-0JH12	–	–	–	–	–	–
–	3VA9234-0JH12	3VA9244-0JH12	–	–	–	–	–	–
–	–	–	3VA9474-0JH13	–	–	–	–	–
3VA9133-0QA00	–	–	–	–	–	–	–	–
–	3VA9233-0QA00	3VA9243-0QA00	–	–	–	–	–	–
–	–	–	3VA9473-0QA00	–	–	–	–	–
–	–	–	–	3VA9673-0QA00	–	–	–	–
3VA9134-0QA00	–	–	–	–	–	–	–	–
–	3VA9234-0QA00	3VA9244-0QA00	–	–	–	–	–	–
–	–	–	3VA9474-0QA00	–	–	–	–	–
–	–	–	–	3VA9674-0QA00	–	–	–	–
–	–	–	–	–	3VA9873-0QA00 new	–	–	–
–	–	–	–	–	3VA9803-0QA00 new	–	–	–

Connection technology



1 For mounting onto the circuit breaker



2 For mounting on plug-in and withdrawable units

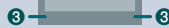

3 Mounting base

For a complete and valid configuration of your molded case circuit breaker, please use our online configurator at www.siemens.com/lowvoltage/3va-ul-configurator

Circular conductor terminals, 1 cable



Number of poles	Connection options	Scope of supply	Cable cross-section		Cu/AL stranded, class B ¹⁾	
			Min.	Max.	Cu	Al
3P	1 2 –	3 single terminals	AWG 14	AWG 8	■	–
			AWG 14	1/0	■	■
					■	–
			AWG 8	3/0	■	■
			AWG 6	350 kcmil	■	■
			AWG 1	600 kcmil	■	■



4P	1 2 –	4 single terminals	AWG 14	AWG 8	■	–
			AWG 14	1/0	■	■
					■	–
			AWG 8	3/0	■	■
			AWG 6	350 kcmil	■	■
			AWG 1	600 kcmil	■	■

Circular conductor terminals with control wire taps, 1 cable



Number of poles	Connection options	Scope of supply	Cable cross-section		Cu/AL stranded, class B ¹⁾	
			Min.	Max.	Cu	Al
3P	1 2 –	3 single terminals	AWG 14	AWG 8	■	–
			AWG 14	1/0	■	■
					■	–
			AWG 8	3/0	■	■
			AWG 6	350 kcmil	■	■
			AWG 1	600 kcmil	■	■



4P	1 2 –	4 single terminals	AWG 14	AWG 8	■	–
			AWG 14	1/0	■	■
					■	–
			AWG 8	3/0	■	■
			AWG 6	350 kcmil	■	■
			AWG 1	600 kcmil	■	■

¹⁾ Al cable only tested according to UL 486 A/B

²⁾ Maximum current-carrying capacity of copper cables 380 A
Maximum current-carrying capacity of aluminum cables 310 A

	3VA51	3VA52	3VA61	3VA53	3VA54	3VA55	3VA65	3VA57	3VA58	3VA59
	3VA51	3VA52	3VA62	3VA63	3VA64	3VA66	3VA67	3VA68	3VA69	
3VA9133-OJB10	–	–	–	–	–	–	–	–	–	–
–	3VA9233-OJB11	–	–	–	–	–	–	–	–	–
–	–	3VA9143-OJB11	–	–	–	–	–	–	–	–
3VA9133-OJB11	–	–	–	–	–	–	–	–	–	–
–	3VA9233-OJB12	3VA9243-OJB12	–	–	–	–	–	–	–	–
–	–	–	3VA9373-OJB13 ²⁾	–	–	–	–	–	–	–
3VA9134-OJB10	–	–	–	–	–	–	–	–	–	–
–	3VA9234-OJB11	–	–	–	–	–	–	–	–	–
–	–	3VA9144-OJB11	–	–	–	–	–	–	–	–
3VA9134-OJB11	–	–	–	–	–	–	–	–	–	–
–	3VA9234-OJB12	3VA9244-OJB12	–	–	–	–	–	–	–	–
–	–	–	3VA9374-OJB13 ²⁾	–	–	–	–	–	–	–
3VA9133-OJG10	–	–	–	–	–	–	–	–	–	–
–	3VA9233-OJG11 new	–	–	–	–	–	–	–	–	–
–	–	3VA9143-OJG11	–	–	–	–	–	–	–	–
3VA9133-OJG11	–	–	–	–	–	–	–	–	–	–
–	3VA9233-OJG12	3VA9243-OJG12	–	–	–	–	–	–	–	–
–	–	–	3VA9373-OJG13	–	–	–	–	–	–	–
3VA9134-OJG10	–	–	–	–	–	–	–	–	–	–
–	3VA9234-OJG11 new	–	–	–	–	–	–	–	–	–
–	–	3VA9144-OJG11	–	–	–	–	–	–	–	–
3VA9134-OJG11	–	–	–	–	–	–	–	–	–	–
–	3VA9234-OJG12	3VA9244-OJG12	–	–	–	–	–	–	–	–
–	–	–	3VA9374-OJG13	–	–	–	–	–	–	–

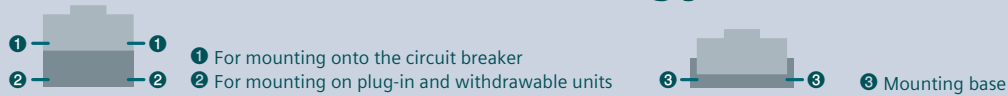

Connection technology





For a complete and valid configuration of your molded case circuit breaker, please use our online configurator at www.siemens.com/lowvoltage/3va-ul-configurator

2

Copper circular conductor terminals, 1 cable

	Number of poles	Connection options			Scope of supply	Cable cross-section, Cu stranded, class B	
		①	②	–		Min.	Max.
	3P	①	②	–	3 single terminals	AWG 14	AWG 8
						AWG 14	2/0
						AWG 14	1/0
						AWG 6	350 kcmil
						AWG 1	600 kcmil
	4P	①	②	–	4 single terminals	AWG 14	AWG 8
						AWG 14	2/0
						AWG 14	1/0
						AWG 6	350 kcmil
						AWG 1	600 kcmil

Copper circular conductor terminals with control wire taps, 1 cable

	Number of poles	Connection options			Scope of supply	Cable cross-section, Cu stranded, class B	
		①	②	–		Min.	Max.
	3P	①	②	–	3 single terminals	AWG 14	AWG 8
						AWG 14	2/0
						AWG 14	1/0
						AWG 6	350 kcmil
						AWG 1	600 kcmil
	4P	①	②	–	4 single terminals	AWG 14	AWG 8
						AWG 14	2/0
						AWG 14	1/0
						AWG 6	350 kcmil
						AWG 1	600 kcmil

Copper circular conductor terminals, 4 cables

	Number of poles	Connection options			Scope of supply	Cable cross-section, Cu stranded, class B	
		①	②	–		Min.	Max.
	3P	①	②	–	3 single terminals long terminal cover	1/0 50	500 kcmil 240 mm ²

Control wire taps for busbars

	Connection options		
	①	–	–

3VA51	3VA52	3VA61	3VA62	3VA53	3VA54	3VA55	3VA57	3VA58	3VA59	
				3VA63	3VA64	3VA65	3VA66	3VA67	3VA68	3VA69
3VA9133-OJD10	–	–	–	–	–	–	–	–	–	–
3VA9133-OJD11	–	–	–	–	–	–	–	–	–	–
–	3VA9233-OJD11 new	3VA9143-OJD11	–	–	–	–	–	–	–	–
–	3VA9233-OJD12	3VA9243-OJD12	–	–	–	–	–	–	–	–
–	–	–	3VA9373-OJD13	–	–	–	–	–	–	–
3VA9134-OJD10	–	–	–	–	–	–	–	–	–	–
3VA9134-OJD11	–	–	–	–	–	–	–	–	–	–
–	3VA9234-OJD11 new	3VA9144-OJD11	–	–	–	–	–	–	–	–
–	3VA9234-OJD12	3VA9244-OJD12	–	–	–	–	–	–	–	–
–	–	–	3VA9374-OJD13	–	–	–	–	–	–	–
3VA9133-OJK10	–	–	–	–	–	–	–	–	–	–
3VA9133-OJK11	–	–	–	–	–	–	–	–	–	–
–	3VA9233-OJK11 new	3VA9143-OJK11	–	–	–	–	–	–	–	–
–	3VA9233-OJK12	3VA9243-OJK12	–	–	–	–	–	–	–	–
–	–	–	3VA9373-OJK13	–	–	–	–	–	–	–
3VA9134-OJK10	–	–	–	–	–	–	–	–	–	–
3VA9134-OJK11	–	–	–	–	–	–	–	–	–	–
–	3VA9234-OJK11	3VA9144-OJK11	–	–	–	–	–	–	–	–
–	3VA9234-OJK12	3VA9244-OJK12	–	–	–	–	–	–	–	–
–	–	–	3VA9374-OJK13	–	–	–	–	–	–	–
–	–	–	–	–	–	3VA9773-OJE43 new	–	–	–	–
–	3VA9270-0WC00	3VA9470-0WC00	–	–	–	–	–	–	–	–

Connection technology



1 For mounting onto the circuit breaker



2 For mounting on plug-in and withdrawable units



3 Mounting base

For a complete and valid configuration of your molded case circuit breaker, please use our online configurator at www.siemens.com/lowvoltage/3va-ul-configurator

Note:

All bus connectors, bus connectors broadened and rear connections are Cu/Sn 6 r plated according to ISO 2093

2

Front bus connectors, with insulating plate, with phase barriers

- 3-pole and 4-pole bus connectors only permitted if used with phase barriers and insulating plate!
- Insulating plate is included in the connection technology scope of supply or can be ordered as a spare part (3VA9...-0W..0).
- Phase barriers are included in the connection technology scope of supply or can be ordered as a spare part (3VA9...-WA00).



Number of poles	Connection options			Scope of supply	Max. tap width		Max. tap thickness	
3P	1	2	–	3 terminals, 2 phase barriers, 1 insulating plate	22 mm	0.9 inch	8 mm	0.3 inch
4P	1	2	–	4 terminals, 3 phase barriers, 1 insulating plate	22 mm	0.9 inch	8 mm	0.3 inch

Front bus connectors, with insulating plate

- 3-pole and 4-pole bus connectors only permitted if used with phase barriers!
- Insulating plate is included in the connection technology scope of supply or can be ordered as a spare part (3VA9...-0W..0).



Number of poles	Connection options			Scope of supply	Max. tap width		Max. tap thickness	
1P	1	–	–	1 terminal	22 mm	0.9 inch	8 mm	0.3 inch
3P	1	2	–	3 terminals, 1 insulating plate	32 mm 40 mm	1.3 inch 1.6 inch	10 mm 12.5 mm	0.4 inch 0.5 inch
4P	1	2	–	4 terminals, 1 insulating plate	32 mm 40 mm	1.3 inch 1.6 inch	10 mm 12.5 mm	0.4 inch 0.5 inch

Front bus connectors, with phase barriers

- 3-pole and 4-pole bus connectors only permitted if used with phase barriers!
- Phase barriers are included in the connection technology scope of supply or can be ordered as a spare part (3VA9...-WA00).

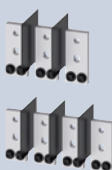

Number of poles	Connection options			Scope of supply	Max. tap width		Max. tap thickness	
3P	1	2	–	3 terminals, 2 phase barriers	50.8 mm	2.0 inch	15.9 mm	0.63 inch
4P	1	2	–	4 terminals, 3 phase barriers	50.8 mm	2.0 inch	15.9 mm	0.63 inch

Front bus connectors



Number of poles	Connection options			Scope of supply
3P	1	–	–	3 terminals, 1 terminal cover Note: The bent connection brackets shown in the picture must be provided by the customer

	3VA51	3VA52	3VA53	3VA61	3VA63	3VA55	3VA57	3VA58	3VA59	
	3VA51	3VA52	3VA54	3VA62	3VA64	3VA65	3VA66	3VA67	3VA68	3VA69
3VA9133-0QB00	-	-	-	-	-	-	-	-	-	
3VA9134-0QB00	-	-	-	-	-	-	-	-	-	
3VA9131-0QB00	-	-	-	-	-	-	-	-	-	
-	3VA9273-0QB00	-	3VA9273-0QB00	-	-	-	-	-	-	
-	-	3VA9473-0QB00	-	3VA9473-0QB00	-	-	-	-	-	
-	-	-	3VA9274-0QB00	-	-	-	-	-	-	
-	-	3VA9474-0QB00	-	3VA9474-0QB00	-	-	-	-	-	
-	-	-	-	-	-	3VA9673-0QB00	-	-	-	
-	-	-	-	-	-	3VA9674-0QB00	-	-	-	
-	-	-	-	-	-	-	3VA9873-0QB00 new	-	-	

Connection technology



1 For mounting onto the circuit breaker



2 For mounting on plug-in and withdrawable units



3 Mounting base

For a complete and valid configuration of your molded case circuit breaker, please use our online configurator at www.siemens.com/lowvoltage/3va-ul-configurator

Note:

All bus connectors, bus connectors broadened and rear connections are Cu/Sn 6 r plated according to ISO 2093

Front bus connectors, for 100% rated MCCB



Number of poles	Connection options	Scope of supply
3P	1 – –	3 terminals, 1 terminal cover Note: The bent connection brackets shown in the picture must be provided by the customer

Front bus connectors broadened, with insulating plate

- 3-pole and 4-pole bus connectors broadened only permitted if used with insulating plate!
- Phase barriers are included in the connection technology scope of supply or can be ordered as a spare part (3VA9...-0W..0).

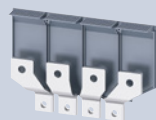

Number of poles	Connection options	Scope of supply	Max. tap width		Max. tap thickness	
3P	1 2 –	3 terminals, 1 insulating plate	60 mm	2.4 inch	12.5 mm	0.5 inch
4P	1 2 –	4 terminals, 1 insulating plate	60 mm	2.4 inch	12.5 mm	0.5 inch

Front bus connectors broadened, with phase barriers

- 3-pole and 4-pole bus connectors broadened only permitted if used with phase barriers!
- Phase barriers are included in the connection technology scope of supply or can be ordered as a spare part (3VA9...-WA00).

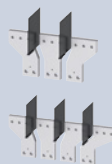

Number of poles	Connection options	Scope of supply	Max. tap width		Max. tap thickness	
3P	1 2 –	3 terminals, 2 phase barriers	60 mm	2.4 inch	12.5 mm	0.5 inch
4P	1 2 –	4 terminals, 3 phase barriers	60 mm	2.4 inch	12.5 mm	0.5 inch

¹⁾ For IEC applications up to 1000 A only. In addition, 3VA9872-0WA00 phase barriers and 3VA9803-0QA00 nut keeper kits are required.

3VA51	3VA52	3VA53 3VA54	3VA61 3VA62	3VA63 3VA64	3VA55 3VA65 3VA66	3VA57 3VA67	3VA58 3VA68	3VA59 3VA69
-	-	-	-	-	-	3VA9873-0QH00 new	-	-
-	-	3VA9473-0QC00	-	3VA9473-0QC00	-	-	-	-
-	-	3VA9474-0QC00	-	3VA9474-0QC00	-	-	-	-
-	-	-	-	-	3VA9673-0QC00	3VA9603-0QC00 ¹⁾ new	-	-
-	-	-	-	-	3VA9674-0QC00	-	-	-

Connection technology



1 For mounting onto the circuit breaker

2 For mounting on plug-in and withdrawable units



3 Mounting base



For a complete and valid configuration of your molded case circuit breaker, please use our online configurator at www.siemens.com/lowvoltage/3va-ul-configurator

Note:



All bus connectors, bus connectors broadened and rear connections are Cu/Sn 6 r plated according to ISO 2093

2



Rear connection studs flat

	Number of poles	Connection options	Scope of supply
	1P	1 2 –	1 short connection stud flat 1 long connection stud flat
	3P	1 2 –	2 short connection studs flat, 1 long connection stud flat
	4P	1 2 –	2 short connection studs flat, 2 long connection studs flat



Rear connectors vertical

	Number of poles	Connection options	Scope of supply
	1P	1 – –	1 rear connector
	3P	1 – –	3 rear connectors
	4P	1 – –	4 rear connectors

Rear connectors horizontal

	Number of poles	Connection options	Scope of supply
	3P	1 – –	3 rear connectors
	4P	1 – –	4 rear connectors

Rear connection studs round

	Number of poles	Connection options	Scope of supply
	1P	1 2 –	1 short connection stud round 1 long connection stud round
	3P	1 2 –	1 long connection stud round, 2 short connection studs round
	4P	1 2 –	2 long connection studs round, 2 short connection studs round

					3VA55					
		3VA53	3VA61	3VA63	3VA65	3VA57	3VA58	3VA59		
3VA51	3VA52	3VA54	3VA62	3VA64	3VA66	3VA67	3VA68	3VA69		
3VA9131-0QE10	3VA9231-0QE10	3VA9471-0QE10	3VA9241-0QE10	3VA9471-0QE10	–	–	–	–		
3VA9131-0QE20	3VA9231-0QE20	3VA9471-0QE20	3VA9241-0QE20	3VA9471-0QE20	–	–	–	–		
3VA9133-0QE00	3VA9233-0QE00	3VA9473-0QE00	3VA9243-0QE00	3VA9473-0QE00	–	–	–	–		
3VA9134-0QE00	3VA9234-0QE00	3VA9474-0QE00	3VA9244-0QE00	3VA9474-0QE00	–	–	–	–		
–	–	–	–	–	–	3VA9773-0QE10 new	–	–		
–	–	–	–	–	3VA9673-0QE00 new	3VA9773-0QE00 new	–	–		
–	–	–	–	–	3VA9674-0QE00 new	–	–	–		
–	–	–	–	–	3VA9673-0QE60 new	–	–	–		
–	–	–	–	–	3VA9674-0QE60 new	–	–	–		
3VA9131-0QF10	3VA9231-0QF10	3VA9471-0QF10	3VA9241-0QF10	3VA9471-0QF10	–	–	–	–		
3VA9131-0QF20	3VA9231-0QF20	3VA9471-0QF20	3VA9241-0QF20	3VA9471-0QF20	–	–	–	–		
3VA9133-0QF00	3VA9233-0QF00	3VA9473-0QF00	3VA9243-0QF00	3VA9473-0QF00	–	–	–	–		
3VA9134-0QF00	3VA9234-0QF00	3VA9474-0QF00	3VA9244-0QF00	3VA9474-0QF00	–	–	–	–		

Connection technology



① For mounting onto the circuit breaker





② For mounting on plug-in and withdrawable units





③ Mounting base

For a complete and valid configuration of your molded case circuit breaker, please use our online configurator at www.siemens.com/lowvoltage/3va-ul-configurator

Circular conductor terminals, large, 1 cable

	Number of poles	Connection options	Scope of supply	Cable cross-section		Cu/AL stranded, class B ¹⁾	
				Min.	Max.	Cu	Al
	2P	① - -	2 single terminals, 1 extended terminal cover	AWG 4	300 kcmil	■	■
	3P	① - -	3 single terminals, 1 extended terminal cover	AWG 4	300 kcmil	■	■
	4P	① - -	4 single terminals, 1 extended terminal cover	AWG 4	300 kcmil	■	■

Circular conductor terminals, large with control wire taps, 1 cable

	Number of poles	Connection options	Scope of supply	Cable cross-section		Cu/AL stranded, class B ¹⁾	
				Min.	Max.	Cu	Al
	2P	① - -	2 single terminals, 1 extended terminal cover	AWG 4	300 kcmil	■	■
	3P	① - -	3 single terminals, 1 extended terminal cover	AWG 4	300 kcmil	■	■
	4P	① - -	4 single terminals, 1 extended terminal cover	AWG 4	300 kcmil	■	■

¹⁾ Al cable only tested according to UL 486 A/B

	3VA51	3VA52	3VA53	3VA54	3VA61	3VA62	3VA63	3VA64	3VA55	3VA65	3VA66	3VA57	3VA67	3VA58	3VA68	3VA59	3VA69
3VA9132-0JJ12	–	–	–	–	–	–	–	–	–	–	–	–	–	–	–	–	–
3VA9133-0JJ12	–	–	–	–	–	–	–	–	–	–	–	–	–	–	–	–	–
–	3VA9233-0JJ13	–	–	–	3VA9243-0JJ13	–	–	–	–	–	–	–	–	–	–	–	–
3VA9134-0JJ12	–	–	–	–	–	–	–	–	–	–	–	–	–	–	–	–	–
–	3VA9234-0JJ13	–	–	–	3VA9244-0JJ13	–	–	–	–	–	–	–	–	–	–	–	–
3VA9132-0JC12	–	–	–	–	–	–	–	–	–	–	–	–	–	–	–	–	–
3VA9133-0JC12	–	–	–	–	–	–	–	–	–	–	–	–	–	–	–	–	–
–	3VA9233-0JC13	–	–	–	3VA9243-0JC13	–	–	–	–	–	–	–	–	–	–	–	–
3VA9134-0JC12	–	–	–	–	–	–	–	–	–	–	–	–	–	–	–	–	–
–	3VA9234-0JC13	–	–	–	3VA9244-0JC13	–	–	–	–	–	–	–	–	–	–	–	–

Connection technology

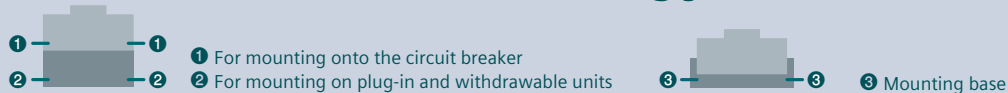

For a complete and valid configuration of your molded case circuit breaker, please use our online configurator at www.siemens.com/lowvoltage/3va-ul-configurator

2

Circular conductor terminals with control wire taps, 2 cables

	Number of poles	Connection options	Scope of supply	Cable cross-section		Cu/AL stranded, class B ¹⁾	
				Min.	Max.	Cu	Al
	3P	1 - -	3 single terminals, 1 extended terminal cover	AWG 4	300 kcmil	■	■
				2/0	600 kcmil	■	■
			3 single terminals, 1 intermediate terminal cover	400 kcmil	750 kcmil	■	-
	3P	1 - -	3 single terminals, 1 short terminal cover	4/0	600 kcmil	■	■
	4P	1 - -	4 single terminals, 1 extended terminal cover	AWG 4	300 kcmil	■	■
				2/0	600 kcmil	■	■
			4 single terminals, 1 intermediate terminal cover	400 kcmil	750 kcmil	■	-
				250 kcmil or 2x 250 kcmil	750 kcmil	■	■
	4P	1 - -	4 single terminals, 1 short terminal cover	4/0	600 kcmil	■	■

Circular conductor terminals with control wire taps, 2 cables

	Number of poles	Connection options	Scope of supply	Cable cross-section		Cu/AL stranded, class B ¹⁾	
				Min.	Max.	Cu	Al
	3P	1 - -	3 single terminals, 1 extended terminal cover	AWG 4	300 kcmil	■	■
				2/0	600 kcmil	■	■
			3 single terminals, 1 intermediate terminal cover	400 kcmil	750 kcmil	■	-
				250 kcmil or 2x 250 kcmil	750 kcmil	■	■
	3P	1 - -	3 single terminals, 1 short terminal cover	4/0	600 kcmil	■	■
	4P	1 - -	4 single terminals, 1 extended terminal cover	AWG 4	300 kcmil	■	■
				2/0	600 kcmil	■	■
			4 single terminals, 1 intermediate terminal cover	400 kcmil	750 kcmil	■	-
				250 kcmil or 2x 250 kcmil	750 kcmil	■	■
	4P	1 - -	4 single terminals, 1 short terminal cover	4/0	600 kcmil	■	■

¹⁾ Al cable only tested according to UL 486 A/B

²⁾ Up to rated current 400 A

3VA51		3VA52		3VA53		3VA54		3VA55		3VA56		3VA57		3VA58		3VA59	
3VA51		3VA52		3VA53		3VA54		3VA55		3VA56		3VA57		3VA58		3VA59	
3VA51		3VA52		3VA53		3VA54		3VA55		3VA56		3VA57		3VA58		3VA59	
–	3VA9233-0JJ22	–	3VA9243-0JJ22	–	–	–	–	–	–	–	–	–	–	–	–	–	–
–	–	3VA9473-0JJ23	–	3VA9473-0JJ23	–	–	–	–	–	–	–	–	–	–	–	–	–
–	–	–	–	–	–	–	–	3VA9673-0JJ24	–	–	–	–	–	–	–	–	–
–	–	3VA9373-0JJ24 ²⁾ new	–	3VA9373-0JJ24 ²⁾ new	–	–	–	–	–	–	–	–	–	–	–	–	–
–	–	–	–	–	–	–	–	3VA9573-0JB23	–	–	–	–	–	–	–	–	–
–	3VA9234-0JJ22	–	3VA9244-0JJ22	–	–	–	–	–	–	–	–	–	–	–	–	–	–
–	–	3VA9474-0JJ23	–	3VA9474-0JJ23	–	–	–	–	–	–	–	–	–	–	–	–	–
–	–	–	–	–	–	–	–	3VA9674-0JJ24	–	–	–	–	–	–	–	–	–
–	–	3VA9374-0JJ24 ²⁾ new	–	3VA9374-0JJ24 ²⁾ new	–	–	–	–	–	–	–	–	–	–	–	–	–
–	–	–	–	–	–	–	–	3VA9574-0JB23	–	–	–	–	–	–	–	–	–
–	3VA9233-0JC22	–	3VA9243-0JC22	–	–	–	–	–	–	–	–	–	–	–	–	–	–
–	–	3VA9473-0JC23	–	3VA9473-0JC23	–	–	–	–	–	–	–	–	–	–	–	–	–
–	–	–	–	–	–	–	–	3VA9673-0JC24	–	–	–	–	–	–	–	–	–
–	–	3VA9373-0JC24 ²⁾ new	–	3VA9373-0JC24 ²⁾ new	–	–	–	–	–	–	–	–	–	–	–	–	–
–	–	–	–	–	–	–	–	3VA9573-0JG23	–	–	–	–	–	–	–	–	–
–	3VA9234-0JC22	–	3VA9244-0JC22	–	–	–	–	–	–	–	–	–	–	–	–	–	–
–	–	3VA9474-0JC23	–	3VA9474-0JC23	–	–	–	–	–	–	–	–	–	–	–	–	–
–	–	–	–	–	–	–	–	3VA9674-0JC24	–	–	–	–	–	–	–	–	–
–	–	3VA9374-0JC24 ²⁾ new	–	3VA9374-0JC24 ²⁾ new	–	–	–	–	–	–	–	–	–	–	–	–	–
–	–	–	–	–	–	–	–	3VA9574-0JG23	–	–	–	–	–	–	–	–	–

Connection technology



1 For mounting onto the circuit breaker

2 For mounting on plug-in and withdrawable units



3 Mounting base

For a complete and valid configuration of your molded case circuit breaker, please use our online configurator at www.siemens.com/lowvoltage/3va-ul-configurator

2

Circular conductor terminals with control wire taps, 3 cables

	Number of poles	Connection options		Scope of supply	Cable cross-section		Cu/AL stranded, class B ¹⁾	
		1	2		Min.	Max.	Cu	Al
	2P	1	-	3 single terminals, 1 long terminal cover	Min.	750 kcmil	■	■
					Max.	300 mm ²		
	3P	1	-	3 single terminals, 1 short terminal cover	4/0	400 kcmil	■	■
				3 single terminals, 1 extended terminal cover	500 kcmil	750 kcmil	■	■
				3 single terminals, 1 long terminal cover	500 kcmil	750 kcmil	■	■
	4P	1	-	4 single terminals, 1 short terminal cover	4/0	400 kcmil	■	■
				4 single terminals, 1 extended terminal cover	500 kcmil	750 kcmil	■	■

Circular conductor terminals with control wire taps, 3 cables

	Number of poles	Connection options		Scope of supply	Cable cross-section		Cu/AL stranded, class B ¹⁾	
		1	2		Min.	Max.	Cu	Al
	3P	1	-	3 single terminals, 1 short terminal cover	Min.	400 kcmil	■	■
					Max.			
	3P	1	-	3 single terminals, 1 extended terminal cover	500 kcmil	750 kcmil	■	■
	4P	1	-	4 single terminals, 1 short terminal cover	4/0	400 kcmil	■	■
	4P	1	-	4 single terminals, 1 extended terminal cover	500 kcmil	750 kcmil	■	■

¹⁾ Al cable only tested according to UL 486 A/B

3VA51	3VA52	3VA53	3VA61	3VA63	3VA55	3VA57	3VA58	3VA59
3VA54	3VA62	3VA64	3VA65	3VA66	3VA67	3VA68	3VA69	
-	-	-	-	-	-	3VA9772-0JJ34 new	-	-
-	-	-	-	-	3VA9673-0JB32	-	-	-
-	-	-	-	-	3VA9673-0JJ34	-	-	-
-	-	-	-	-	-	3VA9773-0JJ34 new	-	-
-	-	-	-	-	3VA9674-0JB32	-	-	-
-	-	-	-	-	3VA9674-0JJ34	-	-	-
-	-	-	-	-	3VA9673-0JG32	-	-	-
-	-	-	-	-	3VA9673-0JC34	-	-	-
-	-	-	-	-	3VA9674-0JG32	-	-	-
-	-	-	-	-	3VA9674-0JC34	-	-	-

Connection technology



1 For mounting onto the circuit breaker



2 For mounting on plug-in and withdrawable units



3 Mounting base

For a complete and valid configuration of your molded case circuit breaker, please use our online configurator at www.siemens.com/lowvoltage/3va-ul-configurator

2

Circular conductor terminals, 4 cables

	Number of poles	Connection options	Scope of supply	Cable cross-section		Cu/AL stranded, class B ¹⁾	
				Min.	Max.	Cu	Al
	2P	1 – –	2 single terminals, 1 long terminal cover	1/0 50 mm ²	500 kcmil 240 mm ²	■	■
			3 single terminals, 1 intermediate terminal cover	4/0	500 kcmil	■	■
			3 single terminals, 1 extended terminal cover	4/0	600 kcmil	■	■
	3P	1 – –	3 single terminals, 1 intermediate terminal cover	4/0	500 kcmil	■	■
			3 single terminals, 1 extended terminal cover	4/0	600 kcmil	■	■
			3 single terminals, 1 long terminal cover	1/0 50 mm ²	500 kcmil 240 mm ²	■	■
			4 single terminals, 1 intermediate terminal cover	4/0	500 kcmil	■	■
	4P	1 – –	4 single terminals, 1 intermediate terminal cover	4/0	500 kcmil	■	■
			4 single terminals, 1 extended terminal cover	4/0	600 kcmil	■	■
			4 single terminals, 1 long terminal cover	1/0 50 mm ²	500 kcmil 240 mm ²	■	■

Circular conductor terminals with control wire taps, 4 cables

	Number of poles	Connection options	Scope of supply	Cable cross-section		Cu/AL stranded, class B ¹⁾	
				Min.	Max.	Cu	Al
	3P	1 – –	3 single terminals, 1 intermediate terminal cover	4/0	500 kcmil	■	■
			3 single terminals, 1 extended terminal cover	4/0	600 kcmil	■	■
			3 single terminals, 1 long terminal cover	1/0 50 mm ²	500 kcmil 240 mm ²	■	■
	4P	1 – –	4 single terminals, 1 intermediate terminal cover	4/0	500 kcmil	■	■
			4 single terminals, 1 extended terminal cover	4/0	600 kcmil	■	■
			4 single terminals, 1 long terminal cover	1/0 50 mm ²	500 kcmil 240 mm ²	■	■

Circular conductor terminals with control wire taps, 4 cables

	Number of poles	Connection options	Scope of supply	Cable cross-section		Cu/AL stranded, class B ¹⁾	
				Min.	Max.	Cu	Al
	3P	1 – –	3 single terminals, 1 long terminal cover	1/0 50 mm ²	500 kcmil 240 mm ²	■	■

¹⁾ Al cable only tested according to UL 486 A/B

3VA51	3VA52	3VA53	3VA61	3VA63	3VA55	3VA57	3VA58	3VA59
3VA54	3VA62	3VA64	3VA65	3VA66	3VA67	3VA68	3VA69	
-	-	-	-	-	-	3VA9772-0JJ43 new	-	-
-	-	-	-	-	3VA9673-0JJ43	-	-	-
-	-	-	-	-	3VA9673-0JJ44 new	-	-	-
-	-	-	-	-	-	3VA9773-0JJ43 new	-	-
-	-	-	-	-	3VA9674-0JJ43	-	-	-
-	-	-	-	-	3VA9674-0JJ44 new	-	-	-
-	-	-	-	-	3VA9673-0JC43	-	-	-
-	-	-	-	-	3VA9673-0JC44 new	-	-	-
-	-	-	-	-	-	3VA9773-0JC43 new	-	-
-	-	-	-	-	3VA9674-0JC43	-	-	-
-	-	-	-	-	3VA9674-0JC44 new	-	-	-
-	-	-	-	-	-	3VA9773-0JM43 new	-	-

Connection technology



1 For mounting onto the circuit breaker



2 For mounting on plug-in and withdrawable units



3 Mounting base

For a complete and valid configuration of your molded case circuit breaker, please use our online configurator at www.siemens.com/lowvoltage/3va-ul-configurator

2

Circular conductor terminals for mounting base, for UL applications only

- Note:**

For more information, see operating instructions L1V30821788001 at www.siemens.com/lowvoltage/manuals

- Scope of supply:

- 1 single terminal
- 1 mounting screw kit
- Individually packed

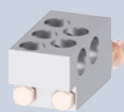

Connection	Connection options	Cable cross-section		Cu/AL stranded, class B ¹⁾	
		Min.	Max.	Cu	Al
4 cables	– – 3	600 kcmil	750 kcmil	■	■
5 cables	– – 3	300 kcmil	600 kcmil	■	■
6 cables	– – 3	300 kcmil	600 kcmil	■	■

Circular conductor terminals for assembly kit



Number of poles	Connection options	Scope of supply	Cable cross-section		Cu/AL stranded, class B ¹⁾	
			Min.	Max.	Cu	Al
3P	1 – –	3 single terminals 3 mounting screws	1/0 50 mm ²	750 kcmil 300 mm ²	■	■

3VA51	3VA52	3VA53	3VA61	3VA63	3VA55	3VA57	3VA58	3VA59
3VA54	3VA62	3VA64	3VA65	3VA66	3VA67	3VA68	3VA69	
-	-	-	-	-	-	-	3VA9771-0JJ44 new	-
-	-	-	-	-	-	-	3VA9771-0JJ53 new	-
-	-	-	-	-	-	-	3VA9871-0JJ63 new	-
-	-	-	-	-	-	-	3VA9773-0JJ64 new	-

Connection technology



① For mounting onto the circuit breaker

② For mounting on plug-in and withdrawable units





③ Mounting base



For a complete and valid configuration of your molded case circuit breaker, please use our online configurator at www.siemens.com/lowvoltage/3va-ul-configurator

2



Circular conductor terminals, 6 cables

	Number of poles	Connection options	Scope of supply	Cable cross-section		Cu/AL stranded, class B ¹⁾	
				Min.	Max.	Cu	Al
	2P	① – –	2 single terminals, 1 extended terminal cover	AWG 14	AWG 2	■	■
	3P	① – –	3 single terminals, 1 extended terminal cover	AWG 14	AWG 2	■	■
	4P	① – –	4 single terminals, 1 extended terminal cover	AWG 14	AWG 2	■	■

Copper circular conductor terminals, 2 cables

	Number of poles	Connection options	Scope of supply	Cable cross-section, Cu stranded, class B	
				Min.	Max.
	3P	① – –	3 single terminals, 1 extended terminal cover	2/0	600 kcmil
	4P	① – –	4 single terminals, 1 extended terminal cover	2/0	600 kcmil

Copper circular conductor terminals with control wire taps, 2 cables

	Number of poles	Connection options	Scope of supply	Cable cross-section, Cu stranded, class B	
				Min.	Max.
	3P	① – –	3 single terminals, 1 extended terminal cover	2/0	600 kcmil
	4P	① – –	4 single terminals, 1 extended terminal cover	2/0	600 kcmil

¹⁾ Al cable only tested according to UL 486 A/B

	3VA51	3VA52	3VA53 3VA54	3VA61 3VA62	3VA63 3VA64	3VA55 3VA65 3VA66	3VA57 3VA67	3VA58 3VA68	3VA59 3VA69
3VA9132-0JF60	–	–	–	–	–	–	–	–	–
3VA9133-0JF60	3VA9233-0JF60	–	3VA9243-0JF60	3VA9373-0JF60	–	–	–	–	–
3VA9134-0JF60	3VA9234-0JF60	–	3VA9244-0JF60	3VA9374-0JF60	–	–	–	–	–
–	–	3VA9473-0JE23	–	3VA9473-0JE23	–	–	–	–	–
–	–	3VA9474-0JE23	–	3VA9474-0JE23	–	–	–	–	–
–	–	3VA9473-0JL23	–	3VA9473-0JL23	–	–	–	–	–
–	–	3VA9474-0JL23	–	3VA9474-0JL23	–	–	–	–	–

Connection technology

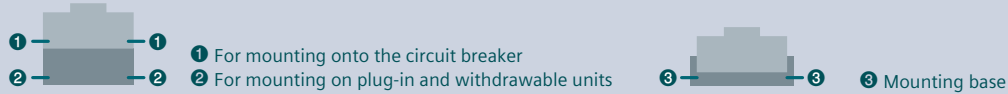



For a complete and valid configuration of your molded case circuit breaker, please use our online configurator at www.siemens.com/lowvoltage/3va-ul-configurator



2

3VA51

Copper circular conductor terminals with auxiliary conductor connection, 3 cables

	Number of poles	Connection options	Scope of supply	Cable cross-section, Cu stranded, class B		
				Min.	Max.	
	3P	① - -	3 single terminals 1 short terminal cover	4/0	400 kcmil	-
	4P	① - -	4 single terminals 1 short terminal cover	4/0	400 kcmil	-





Copper circular conductor terminals with auxiliary conductor connection, 4 cables

	Number of poles	Connection options	Scope of supply	Cable cross-section, Cu stranded, class B		
				Min.	Max.	
	3P	① - -	3 single terminals 1 intermediate terminal cover	4/0	500 kcmil	-
	4P	① - -	4 single terminals 1 intermediate terminal cover	4/0	500 kcmil	-

Copper circular conductor terminals for mounting base, for UL only

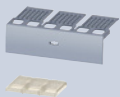
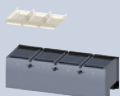
	Connection	Connection options	Scope of supply	Cable cross-section, Cu stranded, class B		
				Min.	Max.	
	5 cables	- - ③	1 single terminal 1 mounting screw kit	300 kcmil	600 kcmil	-

Terminal covers for fixed-mounted, plug-in and withdrawable units

	Version	Number of poles	Mounting location			
			①	-	-	
	Short	1P	①	-	-	3VA9131-0WD10
		3P	①	-	-	3VA9131-0WD30
		4P	①	-	-	3VA9131-0WD40
	Intermediate ¹⁾	3P	①	-	-	-
		4P	①	-	-	-
	Extended	2P	①	-	-	3VA9131-0WF20
		3P	①	-	-	3VA9131-0WF30
		4P	①	-	-	3VA9131-0WF40
	Broadened	3P	①	-	-	-
		4P	①	-	-	-
	Long	3P	①	-	-	-

¹⁾ Suitable for circular conductor terminals 2/3/4 cables

3VA52	3VA61 3VA62	3VA53 3VA54	3VA63 3VA64	3VA55 3VA65 3VA66	3VA57 3VA67	3VA58 3VA68	3VA59 3VA69
-	-	-	-	3VA9673-0JK32 new	-	-	-
-	-	-	-	3VA9674-0JK32 new	-	-	-
-	-	-	-	3VA9673-0JL43 new	3VA9773-0JE43 new	-	-
-	-	-	-	3VA9674-0JL43 new	-	-	-
-	-	-	-	-	-	3VA9871-0JE53 new	-
3VA9271-0WD30	-	3VA9471-0WD30	-	3VA9671-0WD30	-	3VA9871-0WD30 new	-
3VA9271-0WD40	-	3VA9471-0WD40	-	3VA9671-0WD40	-	-	-
-	-	-	-	3VA9671-0WE30	-	-	-
-	-	-	-	3VA9671-0WE40	-	-	-
-	-	-	-	-	-	-	-
3VA9271-0WF30	-	3VA9471-0WF30	-	3VA9671-0WF30 new	-	-	-
3VA9271-0WF40	-	3VA9471-0WF40	-	3VA9671-0WF40 new	-	-	-
-	-	3VA9471-0WG30	-	-	-	-	-
-	-	3VA9471-0WG40	-	-	-	-	-
-	-	-	-	-	3VA9771-0WP30 new	-	-
-	-	-	-	-	3VA9871-0WP30 new	-	-
-	-	-	-	-	3VA9871-0WF30 new	-	-

Connection technology



1 For mounting onto the circuit breaker

2 For mounting on plug-in and withdrawable units

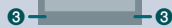

3 Mounting base

For a complete and valid configuration of your molded case circuit breaker, please use our online configurator at www.siemens.com/lowvoltage/3va-ul-configurator

2

3VA51

Terminal covers for plug-in and withdrawable units (spare part)

- To provide circuit breaker touch protection
- For mounting to the molded case circuit breaker

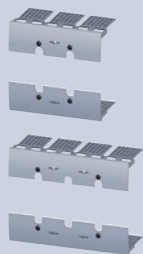

Number of poles	Mounting location
3P	1 – –
4P	1 – –

Insulating plates specially for fixed-mounted versions



Version	Number of poles	Mounting location	
Standard	2P	1 – –	3VA9131-0WJ20
	3P	1 – –	3VA9131-0WJ30
	4P	1 – –	3VA9131-0WJ40
Broadened	3P	1 – –	–
	4P	1 – –	–

Phase barriers



Scope of supply	Mounting location	
2 phase barriers	1 2 –	3VA9132-0WA00

	3VA61	3VA53	3VA63	3VA55	3VA65	3VA57	3VA58	3VA59
3VA52	3VA62	3VA54	3VA64	3VA66	3VA67	3VA68	3VA69	
–	3VA9143-OKB01	–	3VA9343-OKB01	–	–	–	–	–
–	3VA9144-OKB01	–	3VA9344-OKB01	–	–	–	–	–
–	–	–	–	–	–	–	–	–
3VA9271-0WJ30		3VA9471-0WJ30		–	–	–	–	–
3VA9271-0WJ40		3VA9471-0WJ40		–	–	–	–	–
–	–	3VA9471-0WK30		–	–	–	–	–
–	–	3VA9471-0WK40		–	–	–	–	–
3VA9272-0WA00		3VA9472-0WA00		3VA9672-0WA00		3VA9872-0WA00 new		

2

Plug-in and withdrawable technology

The main differences between plug-in units and withdrawable units are convenience of operation and the potential for functional expansion.

Thanks to plug-in and withdrawable technology:

- Molded case circuit breakers can be replaced quickly and easily for overhauls or servicing
- Electrical isolation and clearly visible isolating distance
- The socket can be interlocked to prevent the 3VA molded case circuit breaker from being plugged in or moved in
- Identical connection technology for all molded case circuit breakers, whether they are plug-in, withdrawable or fixed-mounted units

In addition, withdrawable technology offers:



- Transmission of the position of the molded case circuit breaker via communication (CONNECT, TEST, DISCONNECT)
- The ability to test the auxiliary and control circuit connections in the test position of the withdrawable unit, without contacted main conducting paths
- Transmission of the state of the molded case circuit breaker (ON, OFF, TRIP) via the COM060 communication module



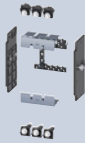

Note:

Plug-in and withdrawable technology are only available for the 3VA6 molded case circuit breaker with electronic trip units. The plug-in and draw-out sockets of circuit breaker sizes 250 A to 400 A (3VA61, 3VA62 and 3VA63) can be equipped with all available terminal types.

For circuit breaker size 600 A (3VA64), special plug-in and withdrawable bases are available. Broadened connecting bars are supplied for this purpose. For temperature reasons, only this connection technology can be used for this size of circuit breaker. 100% rated breakers can never be used with plug-in or withdrawable technology for temperature reasons.





For a complete and valid configuration of your molded case circuit breaker, please use our online configurator at www.siemens.com/lowvoltage/3va-ul-configurator

	3VA61	3VA62	3VA63	3VA64
Withdrawable unit, complete kits				
 <ul style="list-style-type: none"> • Scope of supply: <ul style="list-style-type: none"> – Draw-out socket – Withdrawable unit, conversion kit – Mounting screw kit • Note: The crank for the withdrawable unit must be ordered separately. 				
	Number of poles			
	3P	3VA9143-OKD00	3VA9343-OKD00	3VA9443-OKD00
4P	3VA9144-OKD00	3VA9344-OKD00	3VA9444-OKD00	
Withdrawable units, conversion kits				
 <ul style="list-style-type: none"> • Scope of supply: <ul style="list-style-type: none"> – Screw-fastened terminal covers for molded case circuit breakers – Side panels – Plug-in contacts – Cable cages – Autotrip plunger 				
	Number of poles			
	3P	3VA9143-OKD10	3VA9343-OKD10	
4P	3VA9144-OKD10	3VA9344-OKD10		
Plug-in units, complete kits				
 <ul style="list-style-type: none"> • Scope of supply: <ul style="list-style-type: none"> – Plug-in base – Plug-in unit, conversion kit – Mounting screw kit 				
	Number of poles			
	3P	3VA9143-OKP00	3VA9343-OKP00	3VA9443-OKP00
4P	3VA9144-OKP00	3VA9344-OKP00	3VA9444-OKP00	

		3VA61	3VA62	3VA63	3VA64
Plug-in units, conversion kits					
	<ul style="list-style-type: none"> • Scope of supply: <ul style="list-style-type: none"> – Screw-fastened terminal covers for molded case circuit breakers – Plug-in contacts – Cable cages – Autotrip plunger 				
	Number of poles				
	3P	3VA9143-OKP10		3VA9343-OKP10	
4P	3VA9144-OKP10		3VA9344-OKP10		
Cable cages for plug-in/withdrawable units					
	<ul style="list-style-type: none"> • Cable duct for routing of the required cables from the internal accessories on the back of the circuit breaker 				
	Number of poles				
3P/4P	3VA9167-OKB02		–	–	
Door feedthroughs					
	Number of poles				
	3P/4P	3VA9147-OKT00		3VA9347-OKT00	
Spare part autotrip plunger					
	Version				
	Plug-in unit	3VA9267-OKP81		3VA9457-OKP81	
	Withdrawable unit	3VA9267-OKD81		3VA9457-OKD81	

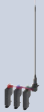
2

Accessories

Communication links for withdrawable unit					
	Scope of supply			Article No.	
	Set of cables with three special position signaling switches, 3VA9987-OKC10 connecting cables			3VA9977-OKC00	
Position signaling switches for withdrawable unit and plug-in unit					
				Article No.	
				3VA9977-OKB00	
Connecting cables					
	Use			Article No.	
	Connection of position signaling switches for communication with COM060			3VA9987-OKC10	
Cranks for withdrawable units					
	Version	Scope of supply		Article No.	
	Insulated	Including crank holder		3VA9987-OKD81	
Auxiliary circuit connectors					
	<ul style="list-style-type: none"> • Each auxiliary circuit connector is designed for 4 cables. 			Article No.	
	Version			3VA9977-OKD80	
	For all withdrawable units			3VA9977-OKP80	
	For all plug-in units				

Plug-in and withdrawable technology

For a complete and valid configuration of your molded case circuit breaker, please use our online configurator at www.siemens.com/lowvoltage/3va-ul-configurator

Cylinder locks



- **Scope of supply:** 1 lock with 2 keys
- For locking or interlocking
- For installation in all rotary operators with a shaft stub
- For mounting in the adapter kit for the accessories compartment

Key	Lock number	Article No.
1	1	3VA9980-OVL10
3	3	3VA9980-OVL30
4	4	3VA9980-OVL40

Cylinder lock adapters for withdrawable units



- To prevent unauthorized withdrawal or insertion of the circuit breaker into the withdrawable unit
- Circuit breaker can be locked in the CONNECT, TEST and DISCONNECT positions

Use	Article No.
For fitting a cylinder lock in the right-hand side wall of the withdrawable unit	3VA9970-OLF40

2

Communication

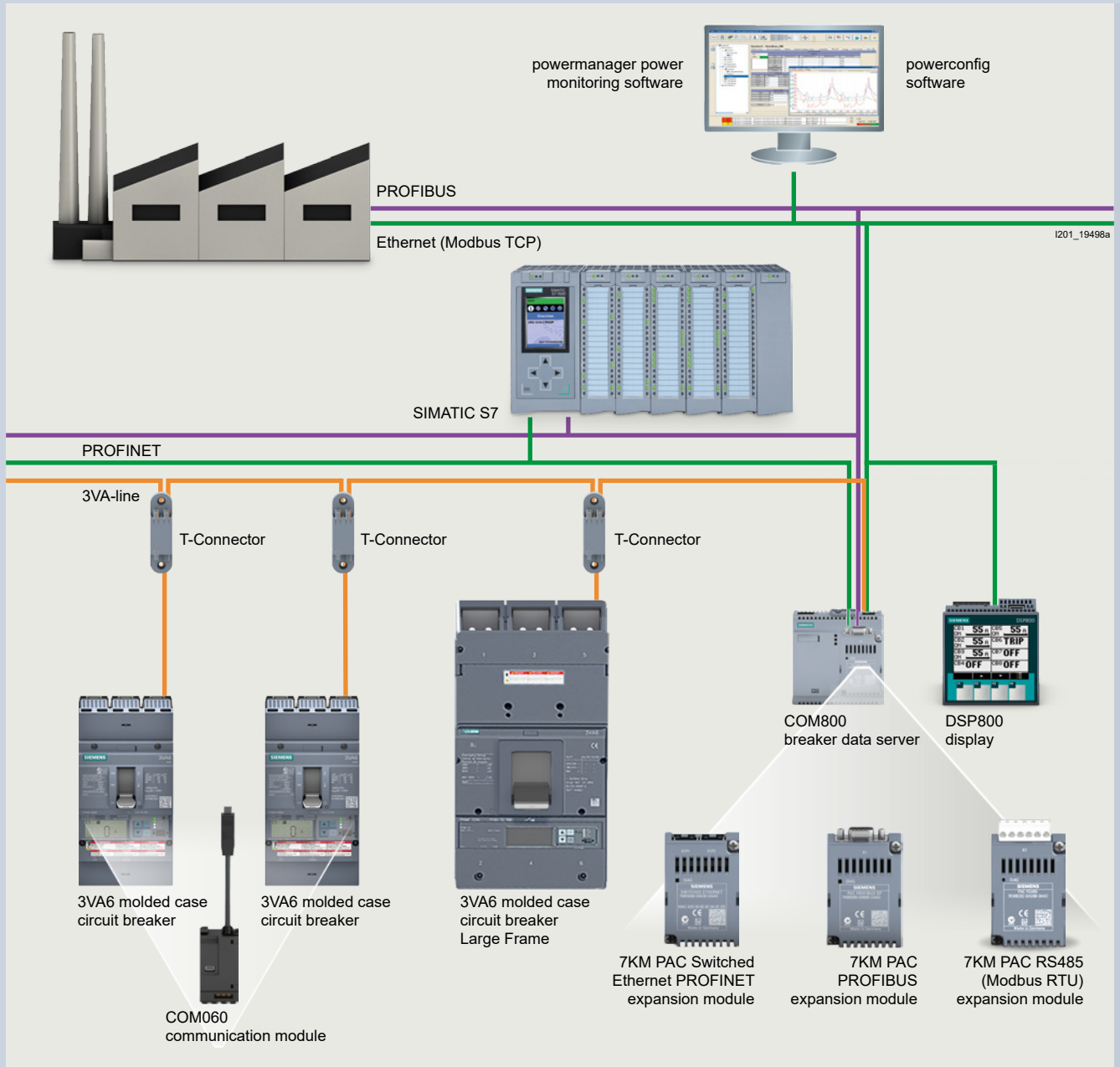

Communication

2

Measurement function ¹⁾			ETU 5-series	ETU 8-series	Display in ETU	Display DSP800	Communication COM800/ COM100
Current							
Phase and neutral conductor currents	I_1, I_2, I_3, I_N	A	■	■	□	□	■
Residual current to ground	I_g	A	■	■	□	□	■
Phase with highest load		A	■	■	□	□	■
Average value over the three phase currents	$I_{\text{leading axis}} = (I_1 + I_2 + I_3)/3$	A	–	■	–	□	■
Asymmetry of the phase currents	I_{nba}	%	–	■	–	□	■
THD of the 3 phases	$THDI_1, THDI_2, THDI_3$	%	–	■	–	□	■
Voltage							
Phase voltages incl. average value	$U_{12}, U_{23}, U_{31}, U_{\text{phavg}}$	V	–	■	□	□	■
Voltages to N conductor incl. average value	$U_{1N}, U_{2N}, U_{3N}, U_{\text{Navg}}$	V	–	■	–	□	■
Voltage unbalance		%	–	■	–	□	■
THD phase/phase and phase/N	$THDI_1, THDI_2, THDI_3$	%	–	■	–	□	■
Power							
Active power, total and per phase	$P_1, P_2, P_3, P_{\text{tot}}$	kW	–	■	□ (P_{tot})	□	■
Apparent power, total and per phase	$S_1, S_2, S_3, S_{\text{tot}}$	kVA	–	■	–	□	■
Reactive power, total and per phase	$Q_1, Q_2, Q_3, Q_{\text{tot}}$	kVAr	–	■	□	□	■
Power factor of the fundamental	$P_{F1}, P_{F2}, P_{F3}, P_{\text{Favg}}$		–	■	□ (P_{Favg})	□	■
Energy							
Active energy, infeed and feedback	E_p	kWh	–	■	□	□	■
Reactive energy, infeed and feedback	E_q	kVArh	–	■	–	□	■
Apparent energy	E_s	kVAh	–	■	–	□	■
Frequency							
Present frequency	f	Hz	–	■	□	□	■
Maximum pointer function							
Min./max. current, voltage, power	With time stamp	–	–	–	–	–	■
Condition monitoring ²⁾							
Operating cycles counter	ON/OFF cycle		■	■	–	–	■
Operating hours		h	■	■	–	–	■
Trip counter	Differentiated in trip reasons		■	■	–	–	■
Health indicator ³⁾	Incl. contact state	%	■	■	■	–	■
Remaining life time ³⁾		Time	■	■	–	–	■

■ Available □ Displayable – Not available

¹⁾ Depending on ETU version

²⁾ Only available with continuous external power supply and COM060 and COM800/100 communication interfaces

³⁾ Firmware 4.4 or higher of ETU, COM060 and COM800/100 required. Not for the 3VA57, 3VA58, 3VA59, 3VA67, 3VA68 and 3VA69

		3VA63	
		3VA64	3VA67
3VA61	3VA65	3VA68	
3VA62	3VA66	3VA69	

COM060 communication modules



- For mounting in the right-hand accessories compartment of the 3VA6 molded case circuit breaker (including ETU power supply)
- Including a T-connector

Use

Communication to the COM800/COM100 breaker data server via 3VA line	3VA9177-0TB10	3VA9377-0TB10	Already integrated
---	---------------	---------------	--------------------

24 V modules







- 24 V DC
- For mounting in the right-hand accessories compartment of the 3VA6

Use









Optional energy supply for the ETU, also includes continuous operation of the ETU display and the measurement function of the ETU 8-series	3VA9177-0TB50	3VA9377-0TB50	Already integrated
--	---------------	---------------	--------------------

Breaker data server

COM800 breaker data servers		
	Version Central communication module for connection of up to eight 3VA6 molded case circuit breakers via the 3VA line, Ethernet 10/100 Mbps interface, module socket for inserting an optional PROFIBUS DP, PROFINET or RS485 module, 2 terminating resistors	Article No. 3VA9977-0TA10
COM100 breaker data servers		
	Version Central communication module for connection of a 3VA6 molded case circuit breaker via the 3VA line, Ethernet 10/100 Mbps interface, module socket for inserting an optional PROFIBUS DP, PROFINET or RS485 module, 2 terminating resistors	Article No. 3VA9977-0TA20
7KM PAC PROFIBUS DP expansion modules		
	Use Used for connecting the COM800/COM100 breaker data server, and the 3VA molded case circuit breakers connected to it, to PROFIBUS DPV1. Supplies the state and measured variables of the 3VA molded case circuit breaker for the PROFIBUS DP master. Receives information (e.g. commands) from the PROFIBUS DP master and transmits them to the 3VA molded case circuit breaker.	Article No. 7KM9300-0AB01-0AA0
7KM PAC Switched Ethernet PROFINET expansion modules		
	Use Used for connecting the COM800/COM100 breaker data server, and the connected 3VA molded case circuit breakers, to PROFINET via two Ethernet interfaces. Supplies the state and measured variables of the 3VA molded case circuit breakers to PROFINET via the PROFINET IO, PROFINET energy and Modbus TCP protocols.	Article No. 7KM9300-0AE02-0AA0
7KM PAC RS485 Modbus RTU expansion modules		
	Use Used for connecting the COM800/COM100 breaker data server, and the 3VA molded case circuit breakers connected to it, to Modbus RTU. Supplies the state and measured variables of the 3VA molded case circuit breaker for the Modbus RTU master. Receives information (e.g. commands) from the Modbus RTU master and transmits them to the 3VA molded case circuit breaker.	Article No. 7KM9300-0AM00-0AA0

Communication

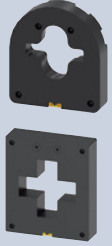
Accessories for communication

T-connectors (spare part)			
	Use		Article No.
		Provides a stub connection to the COM060 and loops through to the next circuit breaker. Including connection adapter for mounting on the 3VA6 circuit breaker enclosure	3VA9987-0TG10
DIN-rail adapters			
	Use		Article No.
		For snapping the T-connector onto a DIN rail	3VA9987-0TG11
Prefabricated connecting cables, T-connector – T-connector or T-connector – COM800/COM100			
	Length		Article No.
		0.4 m	3VA9987-0TC10
		1 m	3VA9987-0TC20
		2 m	3VA9987-0TC30
		4 m	3VA9987-0TC40
Prefabricated connecting cables for extending the COM060 – T-connector stub connection			
	Length		Article No.
		0.4 m	3VA9987-0TF20
		0.8 m	3VA9987-0TF10
Additional bus terminating resistors			
			Article No.
			3VA9987-0TE10
Voltage tap to external N conductors			
	Use		Article No.
		Cable for connection of the star point for the measurement function of the 8-series ETU, length 1.5 m	3VA9987-0UC10
External current transformers as straight-through transformers			
	Use		Article No.
		Connection of an external current transformer for the neutral conductor for 3-pole 3VA6 molded case circuit breakers for 5-series and 8-series ETUs (ETU850, ETU856, ETU860), including connecting cables	
		Rated current I_n	
		25 ... 150 A	3VA9077-0NA10
		160 ... 350 A	3VA9177-0NA10
		400 ... 600 A	3VA9377-0NA10
	600 ... 1200 A	3VA9677-0NA10	
	1600/2000 A	3VA9877-0NA10 new	
Display			
Display DSP800 for connection to COM800/COM100			
	Use		Article No.
		For displaying status, measured values and parameters of up to 8 3VA6 molded case circuit breakers. Connection to the COM800/COM100 via Ethernet for displaying the information of the COM800/COM100 and the connected 3VA6 molded case circuit breakers.	3VA9977-0TD10

External function box

EFB300 external function boxes



- 4 digital outputs for information output
- 1 digital input
- ZSI functionality
- S0 interface
- Including cable 1.5 m in length

Use	Article No.
For connection to the ETU of 3VA6 molded case circuit breakers	3VA9977-0UA10

Connecting cables for EFB300



Length	Use	Article No.
1.5 m		3VA9987-0UB10
3.0 m		3VA9987-0UB20

Maintenance mode box

MMB300 maintenance mode boxes



- 2 digital outputs
- 1 digital input
- 1 3VA-line interface
- Including cable 1.5 m in length

Use	Article No.
Series connection of up to eight 3VA6 molded case circuit breakers to one MMB300 maintenance mode box for activating the Dynamic Arc Sentry Mode (DAS Mode) of the molded case circuit breaker	3VA9977-0UF10

Test devices

TD300 test devices



Use	Connection	Article No.
For activation of the ETU and initiation of a test tripping operation	On the front interface of the ETU	3VA9977-0MA10

TD400 test devices ¹⁾



- Energy supply via batteries or the USB-C interface
- USB-C interface for connecting a PC with powerconfig
- Bluetooth interface for connection to a PC, smartphone or tablet
- ETU parameterization
- Including adapter and connecting cable to 3VA2 molded case circuit breaker and IEC 3WL (ETU Release 2)
- Including case

Use	Connection	Article No.
Initiation of a test tripping operation	On the front interface of the ETU (3VA and IEC 3WL ETU Release 2)	3VW9011-0AT40

TD500 test devices



- USB interface for connecting a PC with powerconfig
- Including external power supply
- Including connecting cable to 3VA2 molded case circuit breaker

Use	Connection	Article No.
Initiation of various test tripping operations (LSING), ETU parameterization	On the front interface of the ETU	3VA9977-0MB10

External power supplies for TD500 (spare part)



Voltage	Article No.
110 ... 240 V AC	3VA9987-0MX10

Connecting cables for connecting TD500 to 3VA6 molded case circuit breakers (spare part)



Article No.
3VA9977-0MY10

¹⁾ A country-specific radio license is required to operate the Bluetooth interface. Before activating the Bluetooth function, ensure that the license is available: www.siemens.com/lowvoltage/certificates

Locking, blocking and interlocking

2

					3VA53
					3VA54
			3VA61		3VA63
	3VA51	3VA52	3VA62	3VA64	3VA64

Locking

- The locking provisions make it possible to lock the 3VA molded case circuit breakers in either the OFF or the ON operating position.

Version



Cylinder lock	Key 1 (lock number 1)	3VA9980-0VL10			
	Key 3 (lock number 3)	3VA9980-0VL30			
	Key 4 (lock number 4)	3VA9980-0VL40			



Adapter kit for mounting the cylinder lock (type RONIS) in the accessories compartment of the molded case circuit breaker	3VA9137-0LF10	3VA9237-0LF10	3VA9147-0LF10	3VA9347-0LF10
---	---------------	---------------	---------------	---------------



Blocking device for handle	3VA9038-0LB10	3VA9378-0LB10		
----------------------------	---------------	---------------	--	--



Locking provision for handle	–	–	–	
------------------------------	---	---	---	--

	3VA57
	3VA58
	3VA59
3VA55	3VA67
3VA65	3VA68
3VA66	3VA69



Locking

2

Use in	Locking in OFF position	Locking in ON position	Front mounting	Rear mounting	Interlocked breakers
3VA9980-0VL10	–	–	–	–	–
3VA9980-0VL30	–	–	–	–	–
3VA9980-0VL40	–	–	–	–	–
3VA9577-0LF10	–	–	–	–	–
3VA9578-0LB10	3VA9877-0LB10 new	–	–	–	–
–	3VA9877-0LB11 new	–	–	–	–

Locking, blocking and interlocking

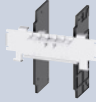
2

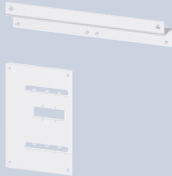
		3VA51	3VA52	3VA61	3VA62	3VA63	3VA64	
Interlocking								
<ul style="list-style-type: none"> Using interlocking technology, it is possible to mutually interlock two or more molded case circuit breakers. The interlock system is designed to ensure that no more than one molded case circuit breaker can be operated at a time. The following methods of interlocking can be used on 3VA molded case circuit breakers: <ul style="list-style-type: none"> Front interlock Rear interlock 								
Version								
	Cylinder lock	Key 1 (lock number 1)					3VA9980-0VL10	
		Key 3 (lock number 3)					3VA9980-0VL30	
		Key 4 (lock number 4)					3VA9980-0VL40	
	Sliding bar interlock for interlocking 2 circuit breakers		3VA9138-0VF30	3VA9238-0VF30	3VA9148-0VF30	3VA9348-0VF30		
	Module for handle interlock with Bowden cable	One module for handle interlock is required for each circuit breaker. A Bowden cable must be ordered separately.	3VA9137-0VF10	3VA9237-0VF10	3VA9147-0VF10	3VA9347-0VF10		
	Bowden cable	Length 0.6 m					3VA9980-0VC10	
		Length 1.0 m					3VA9980-0VC20	
		Length 1.5 m					3VA9980-0VC30	
	Rear interlock with rod	Circuit breaker, fixed-mounted					3VA9078-0VM10	
		Plug-in/withdrawable technology					3VA9078-0VM30	
		Circuit breaker, fixed-mounted	–	–	–			–
	Mounting frame for rear interlock with rod for fixed-mounted version	Profile rails (2 units)					3VA9078-0VK10	
		Mounting plate	3VA9138-0VK20	3VA9238-0VK20	3VA9248-0VK20	3VA9448-0VK20		

¹⁾ Contains mounting plate and profile rails

	3VA57
	3VA58
	3VA59
3VA55	3VA67
3VA65	3VA68
3VA66	3VA69

Interlocking

2

		Use in	Locking in OFF position	Locking in ON position	Front mounting	Rear mounting	Interlocked breakers
3VA9980-OVL10	–	Breakers, motor operators, manual operators, withdrawable technology	■	■	■	–	Unlimited
3VA9980-OVL30	–						
3VA9980-OVL40	–						
–	–	Circuit breaker	–	–	■	–	3
3VA9577-0VF10	3VA9877-0VF10 new	Circuit breaker	–	–	■	–	3
3VA9980-0VC10	–						
3VA9980-0VC20							
3VA9980-0VC30							
3VA9578-0VM10 ¹⁾	–	Circuit breaker, fixed-mounted, Plug-in/withdrawable technology	–	–	–	■	2
–	–						
–	3VA9873-0VM10 new	Circuit breaker, fixed-mounted	–	–	–	■	2
–	–						
–	–	Fixed-mounted	–	–	–	■	
–	–						

Cover frames and mounting

3VA51

Cover frames for door cut-outs for molded case circuit breakers, with access to TMTU/ETU



Number of poles

3P

3VA9033-OSB20

4P

3VA9034-OSB20

Cover frames for door cut-outs for molded case circuit breakers, with access to TMTU/ETU and connection area



Number of poles

3P

-

Cover frames for door cut-outs for molded case circuit breakers, without access to TMTU/ETU



Number of poles

3P

3VA9033-OSB10

4P

3VA9034-OSB10

Cover frames for door cutout for circuit breaker handle only, without access to TMTU/ETU



Number of poles

3P

-

Cover frames for MO320 motor operators



Use

MO320 motor operator

3VA9033-OSB10

Motor operator with SEO520 stored energy operator

-

Cover frames for front mounted rotary operators



3VA9033-OSB10



-

Cover frames for door feedthroughs



-

2

		3VA53 3VA54	3VA55	3VA57	3VA67
	3VA61	3VA63	3VA65	3VA58	3AV68
3VA52	3VA62	3AV64	3VA66	3VA59	3VA69
3VA9233-0SB20	3VA9143-0SB20	3VA9343-0SB20	3VA9583-0SB20	3VA9877-0SB20 new	
3VA9234-0SB20	3VA9144-0SB20	3VA9344-0SB20	3VA9584-0SB20	–	–
–	–	–	–	3VA9877-0SB60 new	
3VA9143-0SB10		3VA9373-0SB10	3VA9583-0SB10	–	–
3VA9144-0SB10		3VA9374-0SB10	3VA9584-0SB10	–	–
–	–	–	–	3VA9877-0SB10 new	
3VA9237-0SB30		3VA9377-0SB30	–	–	–
3VA9147-0SB30		–	–	–	–
3VA9143-0SB10		3VA9373-0SB10	3VA9583-0SB50	–	–
–	–	–	–	3VA9877-0SB30 new	
3VA9233-0SB20		3VA9333-0SB20	–	–	–

Cover frames and mounting

3VA51

Labeling plates for cover frame, not for 3VA9877-0SB10 and 3VA9877-0SB30



3VA9087-0SX10

Adapters for 60 mm busbar system (8US)



- Busbar adapter systems with 60-mm spacing between busbars
- For mounting on the busbar adapter, box terminals for the line side must be ordered separately.
- The connection technology for the outgoing side can be chosen freely

Number of poles

3P	8US1211-4SS00
4P	–

Mounting screw kits with metric thread



Use	Number of poles	
For fixed-mounted breakers	1P	3VA9151-0SS10
	3P	3VA9126-0SS10
	4P	3VA9124-0SS10
	3P and 4P	–
For plug-in and withdrawable technology	–	–

Mounting screw kits with inch thread



Version	Scope of supply	
1/4-20 UNC × 4.0	4 screws and 4 nuts, inch thread	–

Mounting base



Use	
For front connection	–
For rear connection	–

Assembly kit for multiple feed-in terminals and busbars



Use	Number of poles	
For busbars and multiple feed-in terminals	3P	–

		3VA53				
		3VA54	3VA55			
	3VA61	3VA63	3VA65	3VA57	3VA58	3VA59
3VA52	3VA62	3VA64	3VA66	3VA67	3VA68	3VA69
3VA9087-0SX10						
	8US1213-4AP03	8US1213-4AH04	–	–		–
	8US1313-4AH03 new	8US1313-4AM04 new	–	–		–
	–	–	–	–		–
	3VA9126-0SS10	–	–		3VA9874-0SS10 new	
	3VA9124-0SS10	–	–	–		–
	–	–	3VA9328-0SS10	–	–	–
	–	3VA9124-0SS10	3VA9328-0SS10	–	–	–
	–	–	–	–		3VA9874-0SS00 new
	–	–	–	–		3VA9873-0WM00 new
	–	–	–	–		3VA9873-0WN00 new
	–	–	–	–		3VA9873-0WL00 new

2

3VL up to 1600 A, according to UL 489

2



3VL molded case circuit breakers



Product Discontinuation

The 3VL molded case circuit breaker up to 1600 A UL can only be ordered as a spare part since 10/2021 and will be removed from the order portfolio from 10/2025 onwards.

Documents available for downloading:

You can find comprehensive information on the 3VL molded case circuit breaker in the catalog extract

3VL molded case circuit breakers according to UL 489

www.siemens.com/lowvoltage/catalogs (109778213)

VL150X UL,
CG frameVL150 UL,
DG frameVL250 UL,
FG frame

		VL150X UL, CG frame			VL150 UL, DG frame			VL250 UL, FG frame			
Number of poles		3-pole			3-pole			3-pole			
Rated current $I_n^{1)}$		20 A ... 150 A			50 A ... 150 A			100 A ... 250 A			
Frequency		50/60 Hz			50/60 Hz			50/60 Hz			
Electrical characteristics according to UL 489											
Rated operational voltage U_e	50/60 Hz AC	480 V, 600 V/347 V			480 V, 600 V/347 V			480 V, 600 V/347 V			
	DC ²⁾	250 V			500 V			500 V			
Breaking capacity		N	H	L	N	H	L	N	H	L	
Breaking capacity	Up to 240 V AC	kA	65	100	–	65	100	200	65	100	200
	Up to 480 V AC	kA	35	65	–	35	65	100	35	65	100
	Up to 600 V AC	kA	–	–	–	–	–	–	–	–	–
	Up to 600 Y/347 V AC	kA	10	10	–	18	18	18	18	18	18
	Up to 250 V DC ³⁾	kA	30	30	–	30	30	30	30	30	30
	Up to 500 V DC ³⁾⁴⁾	kA	–	–	–	18	18	18	18	25	30
Breaking capacity I_{cu}/I_{cs} rms value according to IEC 60947-2	Up to 240 V AC	kA	65/65	10/75	–	65/65	100/75	200/150	65/65	100/75	200/150
	Up to 415 V AC	kA	40/40	70/70	–	40/40	70/70	100/75	40/40	70/70	100/75
	Up to 690 V AC	kA	8/4 ⁵⁾	10/5 ⁵⁾	–	12/6	12/6	12/6	12/6	12/6	12/6
	Up to 250 V DC ³⁾	kA	30/30	30/30	–	30/30	30/30	30/30	30/30	30/30	30/30
Dimensions											
	A	mm	105			105			105		
	B	mm	157			175			175		
	C	mm	81			81			81		
	D	mm	107			107			107		

¹⁾ 80% rated current applications acc. to UL 489, 100% rated current applications acc. to IEC 60947-2.

²⁾ Rated operational DC voltage applies only to molded case circuit breakers with a thermal-magnetic trip unit.

³⁾ For switching DC, the maximum permissible direct voltage per conducting path must be considered.

⁴⁾ 500 V DC nominal/600 V DC max. for use in ungrounded UPS DC applications (acc. to UL 489, Supplement SC)

⁵⁾ Rated current $I_n \geq 25$ A.



**VL400 UL,
JG frame**



**VL400X UL,
LG frame**



**VL800 UL,
MG frame**



**VL1200 UL,
NG frame**



**VL1600 UL,
PG frame**

VL400 UL, JG frame			VL400X UL, LG frame			VL800 UL, MG frame			VL1200 UL, NG frame			VL1600 UL, PG frame		
3-pole			3-pole			3-pole			3-pole			3-pole		
250 A ... 400 A			400 A ... 600 A			600 A ... 800 A			800 A ... 1200 A			1200 A ... 1600 A		
50/60 Hz			50/60 Hz			50/60 Hz			50/60 Hz			50/60 Hz		
600 V			600 V			600 V			600 V			600 V		
500 V			500 V			500 V			500 V			500 V		
N	H	L	N	H	L	N	H	L	N	H	L	N	H	L
65	100	200	65	100	200	65	100	200	65	100	200	65	100	200
35	65	100	35	65	100	35	65	100	35	65	100	35	65	100
25	25	25	18	18	18	25	35	50	25	35	65	25	35	65
–	–	–	–	–	–	–	–	–	–	–	–	–	–	–
30	30	30	30	30	30	22	25	42	22	25	42	22	25	42
25	35	35	25	35	35	35	50	65	35	50	65	35	50	65
65/65	100/75	200/150	65/65	100/75	200/150	65/65	100/75	200/150	65/35	100/50	200/100	65/35	100/50	200/100
45/45	70/70	100/75	45/45	70/70	100/75	50/50	70/70	100/75	50/25	70/35	100/50	50/25	70/35	100/50
12/6	15/8	15/8	12/6	15/8	15/8	20/10	20/10	20/10	20/10	30/15	35/17	20/10	30/15	35/17
30/30	30/30	30/30	30/30	30/30	30/30	30/30	30/30	30/30	30/30	30/30	30/30	30/30	30/30	30/30
139			139			190			229			229		
279			279			406			406			406		
102			102			118			157			157		
138			138			151			209			209		



Appendix



Link directory	A/2
Conditions of sale and delivery	A/4
Article number index	A/6
Index	A/7
Notes	A/8

Link directory

Catalog LV 18

General information

Information on low-voltage power distribution and electrical installation technology	www.siemens.com/lowvoltage
Tender specifications	www.siemens.com/lowvoltage/tenderspecifications
Conversion tool	www.siemens.com/conversion-tool
Image database	www.siemens.com/lowvoltage/picturedb
CAX download manager	www.siemens.com/cax
Newsletter system	www.siemens.com/lowvoltage/newsletter
Siemens YouTube channel	www.youtube.com/Siemens
Catalog LV 10	www.siemens.com/lv10
Catalog LV 18	www.siemens.com/lv18
Brochures/catalogs	www.siemens.com/lowvoltage/catalogs
Operating instructions/manuals	www.siemens.com/lowvoltage/manuals
Siemens Industry Online Support (SIOS)	www.siemens.com/lowvoltage/product-support
Siemens Industry Online Support app	www.siemens.com/support-app
My Documentation Manager (MDM)	www.siemens.com/lowvoltage/mdm
Configurators	www.siemens.com/lowvoltage/configurators
Siemens Industry Mall – product catalog and online ordering system	www.siemens.com/lowvoltage/mall
Direct forwarding to the Industry Mall	www.siemens.com/product?Article No.
Training	www.siemens.com/sitrain-lowvoltage
Local contacts	www.siemens.com/lowvoltage/contact www.siemens.com/lowvoltage/components/contact www.siemens.com/lowvoltage/systems/contact www.siemens.com/lowvoltage/software/contact
Technical Support	www.siemens.com/support-request
Information on services	www.siemens.com/service-catalog
Control panels for the North American market	www.siemens.com/northamerican-standards
Control panel building	www.siemens.com/controlpanel
Energy savings and amortization	www.automation.siemens.com/sinasave
SIMATIC Energy Suite	www.siemens.com/energysuite
SITOP power supplies	www.siemens.com/sitop
Power distribution with Totally Integrated Power	www.siemens.com/tip

Information + ordering

Technical overviews	
Air circuit breakers	www.siemens.com/lowvoltage/product-support (109766020)
Molded case circuit breakers	www.siemens.com/lowvoltage/product-support (109767421)
All the important things at a glance	
Air circuit breakers	www.siemens.com/3WL
Molded case circuit breakers	www.siemens.com/3VA
Your product in detail	
Technical basic information – 3VA molded case circuit breakers	www.siemens.com/lowvoltage/product-support (109766672)
Siemens YouTube channel	
3WL air circuit breakers (general)	bit.ly/2ZH1rXH
3VA molded case circuit breakers (general)	bit.ly/2xNxIFA
Everything you need for your order	
3WL air circuit breakers/non-automatic air circuit breakers for AC up to 5000 A, UL	sie.ag/2ScRZK7
3VA molded case circuit breakers, UL/IEC	sie.ag/2yPsA2e
Configurators	
3WL air circuit breakers	www.siemens.com/lowvoltage/3wl-configurator
3VA molded case circuit breakers	www.siemens.com/lowvoltage/3va-ul-configurator

Commissioning + operation

Tools/software	
SENTRON powerconfig	www.siemens.com/powerconfig
Manuals	
Communication manual – 3VA molded case circuit breakers with IEC and UL certification	www.siemens.com/lowvoltage/manuals (98746267)
Communication manual – 3WL air circuit breakers via COM35 – PROFINET IO, Modbus TCP	www.siemens.com/lowvoltage/manuals (109757987)
Configuration manual – 3VA selectivity	www.siemens.com/lowvoltage/manuals (109743975)
Configuration manual – 3WL5 air circuit breakers/non-automatic air circuit breakers	www.siemens.com/lowvoltage/manuals (109775570)
Equipment manual – 3VA molded case circuit breakers with UL and IEC certification	www.siemens.com/lowvoltage/manuals (109758561)
System manual – 3WL/3VL circuit breakers with communication capability – Modbus	www.siemens.com/lowvoltage/manuals (39850157)
System manual – 3WL/3VL circuit breakers with communication capability – PROFIBUS	www.siemens.com/lowvoltage/manuals (12560390)
Face-to-face or online training	
Video tutorial on the 3WL air circuit breaker	www.lowvoltage.siemens.com/wcms/3wl-tutorial
Protection systems in low-voltage power distribution	www.siemens.com/sitrain-lowvoltage (WT-LVAPS)
3WL air circuit breakers, sizes 1-3	www.siemens.com/sitrain-lowvoltage (WT-LVA3WL)
3VA molded case circuit breakers	www.siemens.com/sitrain-lowvoltage (WT-LVA3VA)
Communication with SENTRON components	www.siemens.com/sitrain-lowvoltage (LV-COM)
Maintenance and operation of 3WL circuit breakers with subsequent certification option	www.siemens.com/sitrain-lowvoltage (LV-CBMAIN) www.siemens.com/sitrain-lowvoltage (LV-CBCERT)
Project planning and selection of SENTRON circuit breakers	www.siemens.com/sitrain-lowvoltage (LV-CBPROJ)

Conditions of sale and delivery

1. General Provisions

By using this catalog you can purchase products (hardware, software and services) described therein from Siemens Aktiengesellschaft subject to the following Terms and Conditions of Sale and Delivery (hereinafter referred to as „T&C“). Please note that the scope, the quality and the conditions for supplies and services, including software products, by any Siemens entity having a registered office outside Germany, shall be subject exclusively to the General Terms and Conditions of the respective Siemens entity. The following T&C apply exclusively for orders placed with Siemens Aktiengesellschaft, Germany.

1.1 For customers with a seat or registered office in European Union

For customers with a seat or registered office in European Union, the following terms and conditions apply subordinate to T&C:

- for products, which include specific terms and conditions in the description text, these specific terms and conditions shall apply and subordinate thereto,
- for stand-alone software products and software products forming a part of a product or project, the „General License Conditions for Software Products for Automation and Drives for Customers with a Seat or registered Office in Germany“¹⁾ and/or
- for consulting services the „Allgemeine Geschäftsbedingungen für Beratungsleistungen der Division DF – Deutschland“ (available only in German) and/or
- for other services, the „Supplementary Terms and Conditions for Services (‘BL’)¹⁾ and/or
- for other supplies the „General Conditions for the Supply of Products and Services of the Electrical and Electronics Industry“¹⁾.

In case such supplies should contain Open Source Software, the conditions of which shall prevail over the „General Conditions for the Supply of Products and Services of the Electrical and Electronics Industry“¹⁾, a notice will be contained in the scope of delivery in which the applicable conditions for Open Source Software are specified. This shall apply mutatis mutandis for notices referring to other third party software components.

1.2 For customers with a seat or registered office outside European Union

For customers with a seat or registered office outside European Union, the following terms and conditions apply subordinate to T&C:

- for products, which include specific terms and conditions in the description text, these specific terms and conditions shall apply and subordinate thereto,
- for consulting services the „Standard Terms and Conditions for Consulting Services of the Division DF for Customers with a Seat or Registered Office Outside of Germany“¹⁾ and/or
- for other services the „International Terms & Conditions for Services“¹⁾ supplemented by „Software Licensing Conditions“¹⁾ and/or
- for other supplies of hard- and software the „International Terms & Conditions for Products“¹⁾ supplemented by „Software Licensing Conditions“¹⁾

1.3 For customers with master or framework agreement

To the extent our supplies and/or services offered are covered by an existing master or framework agreement, the terms and conditions of that agreement shall apply instead of T&C.

2. Additional Terms and Conditions

The dimensions are in mm. In Germany, according to the German law on units in measuring technology, data in inches apply only to devices for export.

Illustrations are not binding.

Insofar as there are no remarks on the individual pages of this catalog – especially with regard to data, dimensions and weights given – these are subject to change without prior notice.

¹⁾ The text of the Terms and Conditions of Siemens AG can be downloaded at https://mall.industry.siemens.com/legal/ww/en/terms_of_trade_en.pdf

3. Export Regulations

We shall not be obligated to fulfill any agreement if such fulfillment is prevented by any impediments arising out of national or international foreign trade or customs requirements or any embargoes and/or other sanctions.

Export may be subject to license. We shall indicate in the delivery details whether licenses are required under German, European and US export lists.

Our products are controlled by the U.S. Government (when labeled with „ECCN“ unequal „N“) and authorized for export only to the country of ultimate destination for use by the ultimate consignee or end-user(s) herein identified. They may not be resold, transferred, or otherwise disposed of, to any other country or to any person other than the authorized ultimate consignee or end-user(s), either in their original form or after being incorporated into other items, without first obtaining approval from the U.S. Government or as otherwise authorized by U.S. law and regulations. Products labeled with „AL“ unequal „N“ are subject to European/national export authorization.

The export indications can be viewed in advance in the description of the respective goods on the Industry Mall, our online catalog system. Only the export labels „AL“ and „ECCN“ indicated on order confirmations, delivery notes and invoices are authoritative.

Products without label, with label „AL:N“/„ECCN:N“, or label „AL:9X9999“/„ECCN: 9X9999“ may require authorization from responsible authorities depending on the final end-use, or the destination.

If you transfer goods (hardware and/or software and/or technology as well as corresponding documentation, regardless of the mode of provision) delivered by us or works and services (including all kinds of technical support) performed by us to a third party worldwide, you shall comply with all applicable national and international (re-)export control regulations. In any event of such transfer of goods, works and services you shall comply with the (re-) export control regulations of the Federal Republic of Germany, of the European Union and of the United States of America.

Prior to any transfer of goods, works and services provided by us to a third party you shall in particular check and guarantee by appropriate measures that

- there will be no infringement of an embargo imposed by the European Union, by the United States of America and/or by the United Nations by such transfer, by brokering of contracts concerning those goods, works and services or by provision of other economic resources in connection with those goods, works and services, also considering the limitations of domestic business and prohibitions of by-passing those embargos;
- such goods, works and services are not intended for use in connection with armaments, nuclear technology or weapons, if and to the extent such use is subject to prohibition or authorization, unless required authorization is provided;
- the regulations of all applicable Sanctioned Party Lists of the European Union and the United States of America concerning the trading with entities, persons and organizations listed therein are considered.

If required to enable authorities or us to conduct export control checks, you, upon request by us, shall promptly provide us with all information pertaining to the particular end customer, the particular destination and the particular intended use of goods, works and services provided by us, as well as any export control restrictions existing.

You acknowledge that under the EU embargo regulations against Iran, Syria and Russia respectively the sale of certain listed goods and related services is subject to authorization by the competent export control authorities of the European Union. If (1) the goods or services ordered by you are destined for Iran, Syria or Russia, and (2) the contract for our supplies and/or services is subject to prior authorization of the competent export control authorities of the European Union, the contract between you and us shall come into force in this respect only upon granting of such authorization.

The products listed in this catalog may be subject to European/ German and/or US export regulations. Any export requiring approval is therefore subject to authorization by the relevant authorities. Errors excepted and subject to change without prior notice.

Article number index

Article No.	Page
3V	
3VA90	2/34, 2/76, 2/78, 2/80, 2/82, 2/84–2/85
3VA91	1/3, 2/28, 2/30, 2/32, 2/34, 2/36, 2/38, 2/41, 2/43, 2/45, 2/47, 2/49, 2/53, 2/55, 2/65–2/66, 2/68–2/71, 2/74, 2/76, 2/78, 2/80, 2/83–2/85
3VA92	2/28, 2/30, 2/36, 2/38, 2/41, 2/43, 2/45, 2/47, 2/49, 2/53, 2/55, 2/57, 2/65, 2/67, 2/69, 2/71, 2/78, 2/80, 2/83
3VA93	2/45, 2/47, 2/57, 2/65, 2/69–2/71, 2/74, 2/76, 2/78, 2/80, 2/83, 2/85
3VA94	2/28, 2/30, 2/32, 2/34, 2/36, 2/38, 2/41, 2/43, 2/47, 2/49, 2/51, 2/53, 2/57, 2/65, 2/67, 2/69–2/71, 2/80
3VA95	2/38, 2/57, 2/79, 2/81, 2/83
3VA96	2/29, 2/31, 2/33, 2/35, 2/37, 2/39, 2/43, 2/49, 2/51, 2/53, 2/57, 2/59, 2/61, 2/67, 2/69, 2/76
3VA97	2/47, 2/53, 2/59, 2/61, 2/63, 2/67
3VA98	2/29, 2/31, 2/33, 2/35–2/37, 2/39, 2/43, 2/49–2/51, 2/63, 2/67, 2/69, 2/76, 2/79, 2/81, 2/83–2/85
3VA99	2/26–2/27, 2/30, 2/33, 2/36–2/38, 2/40, 2/71–2/72, 2/75–2/81
3VW90	1/38, 2/77
3W	
3WA91	1/36, 1/40–1/41
3WL52	1/5, 1/10–1/11, 1/24
3WL53	1/24
3WL91	1/35–1/45
3WL93	1/35
7K	
7KM93	2/75
8U	
8UC94	2/34
8UD17	2/32–2/33
8UD19	2/32–2/35
8US12	2/84–2/85
8US13	2/85

Index

Keyword	Page
0–9	
3VA5 molded case circuit breakers	2/8–2/11
3VA51–3VA69	2/20–2/41, 2/48–2/85
3VA6 molded case circuit breakers	2/12–2/15
3VL up to 1600 A, according to UL 489	2/86–2/87
3WL5	1/16–1/45
A	
Accessories and spare parts	1/35–1/45
Accessory options	1/24–1/33
Air Circuit Breakers	1/1–1/45
All the information you need	1/2–1/3, 2/2–2/3
Appendix	A/1–A/8
Applications	I/8
Article number index	A/6
B	
Brief code comparison of UL vs. IEC standards	I/7
C	
Circuit breakers and non-automatic circuit	1/4–1/9
Communication	2/73–2/77
Conditions of sale and delivery	A/4–A/5
Connection	1/14
Connection technology	2/42–2/69
Cover frames and mounting	2/82–2/85
E	
Electronic trip units ETU	1/12
G	
Guide frames for AC	1/34
I	
Index	A/7
Internal accessories	2/26
Introduction	I/2–I/9
L	
Link directory	A/2–A/3
Locking, blocking and interlocking	2/78–2/81
M	
Manual operators	2/28–2/39
Molded Case Circuit Breakers	2/1–2/87
Molded case circuit breakers for all applications	2/4–2/5
Motor operators	2/40
N	
Non-automatic circuit breakers for DC	1/10
Notes	A/8
O	
Online configurator highlights	1/18, 2/18

Keyword	Page
Operating mechanism, auxiliary release, auxiliary switch	1/15
Overcurrent protection according to network standards	I/6
Overview of the key US standards	I/4–I/5
P	
Plug-in and withdrawable technology	2/7–2/72
Product approvals in control panel according to UL/NEC	I/9
Q	
Quick selection guide	1/4–1/15, 2/6–2/19
S	
Structure of the article numbers	1/20–1/23, 2/22–2/25
System overview	2/20
T	
The fast route to the product	I/2–I/3
Trip units	2/16

Catalogs and further information



LV 10 Low-Voltage Power Distribution and Electrical Installation Technology

SENTRON • SIVACON • ALPHA

Protection, Switching, Measuring and
Monitoring Devices, Switchboards and
Distribution Systems

PDF (E86060-K8280-A101-B5-7600)



ET D1 Switches and Socket Outlets

DELTA

PDF

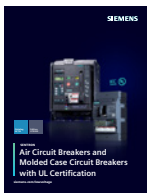

LV 18 Air Circuit Breakers and Molded Case Circuit Breakers with UL Certification

SENTRON

PDF (E86060-K8280-E347-A9-7600)



Industry Mall

Information and Ordering Platform
on the Internet:

www.siemens.com/industrymall



IC 10 Industrial Controls

SIRIUS

PDF (E86060-K1010-A101-B3-7600)

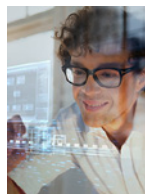

SITRAIN

Digital Industry Academy

www.siemens.com/sitrain



Siemens TIA Selection Tool

for the selection, configuration and
ordering of TIA products and devices

www.siemens.com/tst

The catalogs listed above and additional catalogs are available in PDF format at Siemens Industry Online Support www.siemens.com/lowvoltage/catalogs

Further information on low-voltage power distribution and electrical installation technology is available on the Internet at www.siemens.com/lowvoltage

Get more information

www.siemens.com/lowvoltage

Published by
Siemens AG

Smart Infrastructure
Electrical Products
Siemensstraße 10
93055 Regensburg, Germany

For the U.S. published by
Siemens Industry Inc.

100 Technology Drive
Alpharetta, GA 30005
United States

PDF (E86060-K8280-E347-A9-7600)
KG 0722 152 En
Produced in Germany
© Siemens 2022

Security information

Siemens provides products and solutions with industrial security functions that support the secure operation of plants, systems, machines and networks.

In order to protect plants, systems, machines and networks against cyber threats, it is necessary to implement – and continuously maintain – a holistic, state-of-the-art industrial security concept. Siemens' products and solutions constitute one element of such a concept.

Customers are responsible for preventing unauthorized access to their plants, systems, machines and networks. Such systems, machines and components should only be connected to an enterprise network or the Internet if and to the extent such a connection is necessary and only when appropriate security measures (e.g. firewalls and/or network segmentation) are in place.

For additional information on industrial security measures that may be implemented, please visit <https://www.siemens.com/industrialsecurity>.

Siemens' products and solutions undergo continuous development to make them more secure. Siemens strongly recommends that product updates are applied as soon as they are available and that the latest product versions are used. Use of product versions that are no longer supported, and failure to apply the latest updates may increase customer's exposure to cyber threats.

To stay informed about product updates, subscribe to the Siemens Industrial Security RSS Feed under <https://www.siemens.com/cert>.

Subject to changes and errors. The information given in this document only contains general descriptions and/or performance features which may not always specifically reflect those described, or which may undergo modification in the course of further development of the products. The requested performance features are binding only when they are expressly agreed upon in the concluded contract.

All product designations may be trademarks or other rights of Siemens AG, its affiliated companies or other companies whose use by third parties for their own purposes could violate the rights of the respective owner.