



SIEMENS

SIMATIC PCS 7

SIMATIC PCS 7 Process Control System

Volume 1: System components

Catalog
ST PCS 7

Update
Sept.
2021

[siemens.com/simatic-pcs7](https://www.siemens.com/simatic-pcs7)

Related catalogs

Catalogs for Process Automation

www.siemens.com/pa-catalogs



Process Automation FI 01
 Products for Process Instrumentation

PDF (E86060-K6201-A101-C4-7600)



SIMATIC ST PCS 7 T
 SIMATIC PCS 7 Process Control System
 Vol. 2: Technology components

PDF (E86060-K4678-A141-A5-7600)



Process Automation AP 01
 Process Analytical Instruments

PDF (E86060-K3501-A101-B4-7600)



SIMATIC ST PCS 7 AO
 SIMATIC PCS 7
 Process Control System
 Vol. 3: Add-ons for SIMATIC PCS 7

PDF (E86060-K4678-A121-B5-7600)



Process Automation WT 10
 Products for Weighing Technology

PDF (E86060-K6410-A101-A7-7600)



SIMATIC ST 70
 Products for Totally Integrated Automation

PDF (E86060-K4670-A101-B8-7600)



SITRAIN
 Digital Industry Academy

www.siemens.com/sitrain



SIMATIC HMI / PC-based Automation ST 80/ST PC
 Human Machine Interface Systems
 PC-based Automation

PDF (E86060-K4680-A101-C9-7600)



Industry Mall
 Information and Ordering Platform on the Internet:

www.siemens.com/industrymall



SITOP KT 10.1
 SITOP
 Power Supply

E86060-D4001-A510-E0



Contact
 Your personal contact can be found in our Contacts Database at:

www.siemens.com/automation-contact



SIMATIC PCS 7 V9.1 Process Control System

System components

SIMATIC PCS 7



Catalog ST PCS 7 · May 2021
PDF Update September 2021

Supersedes:

Catalog ST PCS 7 · 2016

Catalog ST PCS 7 · 2017

Refer to the Industry Mall for current updates of this catalog:

www.siemens.com/industrymall

and as PDF at the following address:

www.siemens.com/stpcs7

© Siemens AG 2021

Software Media and Logistics	1
System Administration	2
Engineering System	3
SIMATIC PCS 7 Plant Automation Accelerator	4
Operator System	5
Process data archiving and reporting	6
Plant Device Management	7
Batch automation	8
Route Control	9
Safety Integrated for Process Automation	10
Industrial Security	11
Process Control System IPC	12
Automation systems	13
Industrial communication	14
Process I/O	15
Update/upgrade packages	16
Services for SIMATIC PCS 7	17
Appendix	18



The products and systems described in this catalog are manufactured/distributed under application of a certified quality management system in accordance with DIN EN ISO 9001 (Certified Registration No. 000656 QM08). The certificate is recognized by all IQNet countries.

Digital Enterprise

The building blocks that ensure everything works together perfectly in the digital enterprise

Digitalization is already changing all areas of life and existing business models. It is placing greater pressure on industry while at the same time creating new business opportunities. Today, thanks to scalable solutions from Siemens, companies can already become a digital enterprise and ensure their competitiveness.



Industry faces tremendous challenges



Reduce time-to-market

Today manufacturers have to bring products to market at an ever-increasing pace despite the growing complexity of these products. In the past, a major manufacturer would push aside a small one, but now it is a fast manufacturer that overtakes a slow one.



Boost flexibility

Consumers want customized products, but at a price they would pay for a mass-produced item. That only works if production is more flexible than ever before.



Improve quality

To ensure a high level of quality while meeting legal requirements, companies have to establish closed quality loops and enable the traceability of products.

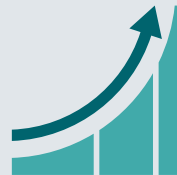

Boost efficiency

Today the product itself needs to be sustainable and environmentally friendly, while energy efficiency in production has become a competitive advantage.



Increase security

Increasing networking escalates the threat to production facilities of cyberattacks. Today more than ever, companies need suitable security measures.



The digital enterprise has already become a reality

To fully benefit from all the advantages of digitalization, companies first have to achieve complete consistency of their data. Fully digitally integrated business processes, including those of suppliers, can help to create a digital representation of the entire value chain. This requires

- the integration of industrial software and automation,
- expansion of the communication networks,
- security in automation,
- and the use of business-specific industrial services.

MindSphere

The cloud-based open IoT operating system from Siemens

With MindSphere, Siemens offers a cost-effective and scalable cloud platform as a service (PaaS) for the development of applications. The platform, designed as an open operating system for the Internet of Things, makes it possible to improve the efficiency of plants by collecting and analyzing large volumes of production data.

Totally Integrated Automation (TIA) Where digitalization becomes reality

Totally Integrated Automation (TIA) ensures the seamless transition from the virtual to the real world. It already encompasses all the necessary conditions for transforming the benefits of digitalization into true added value. The data that will form the digital twin for actual production is generated from a common base.

Digital Plant

Learn more about the digital enterprise for the process industry
www.siemens.com/digitalplant

Digital Enterprise Suite

Learn more about the digital enterprise for the discrete industry
www.siemens.com/digital-enterprise-suite

SIMATIC PCS 7

Room for new perspectives

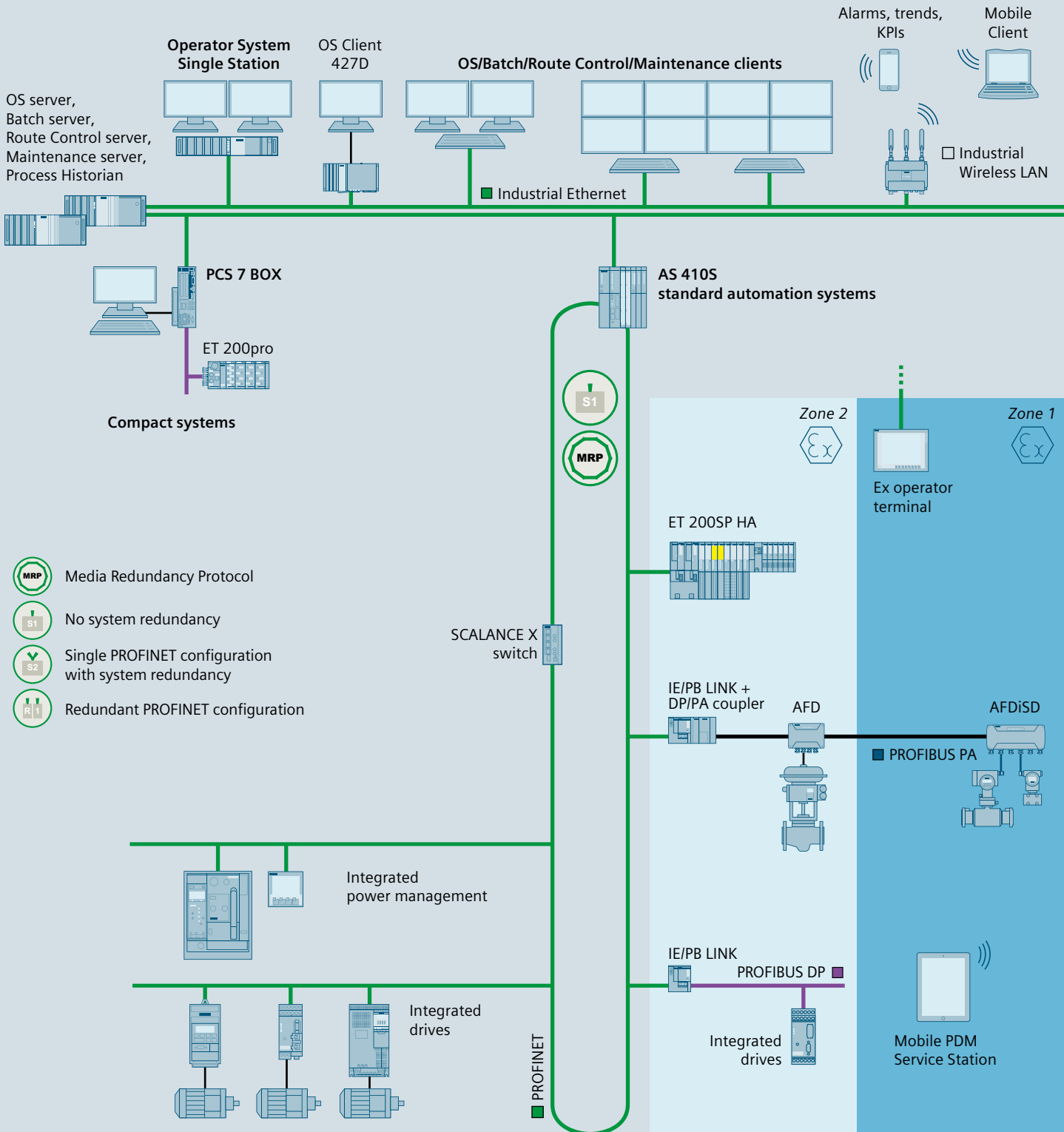

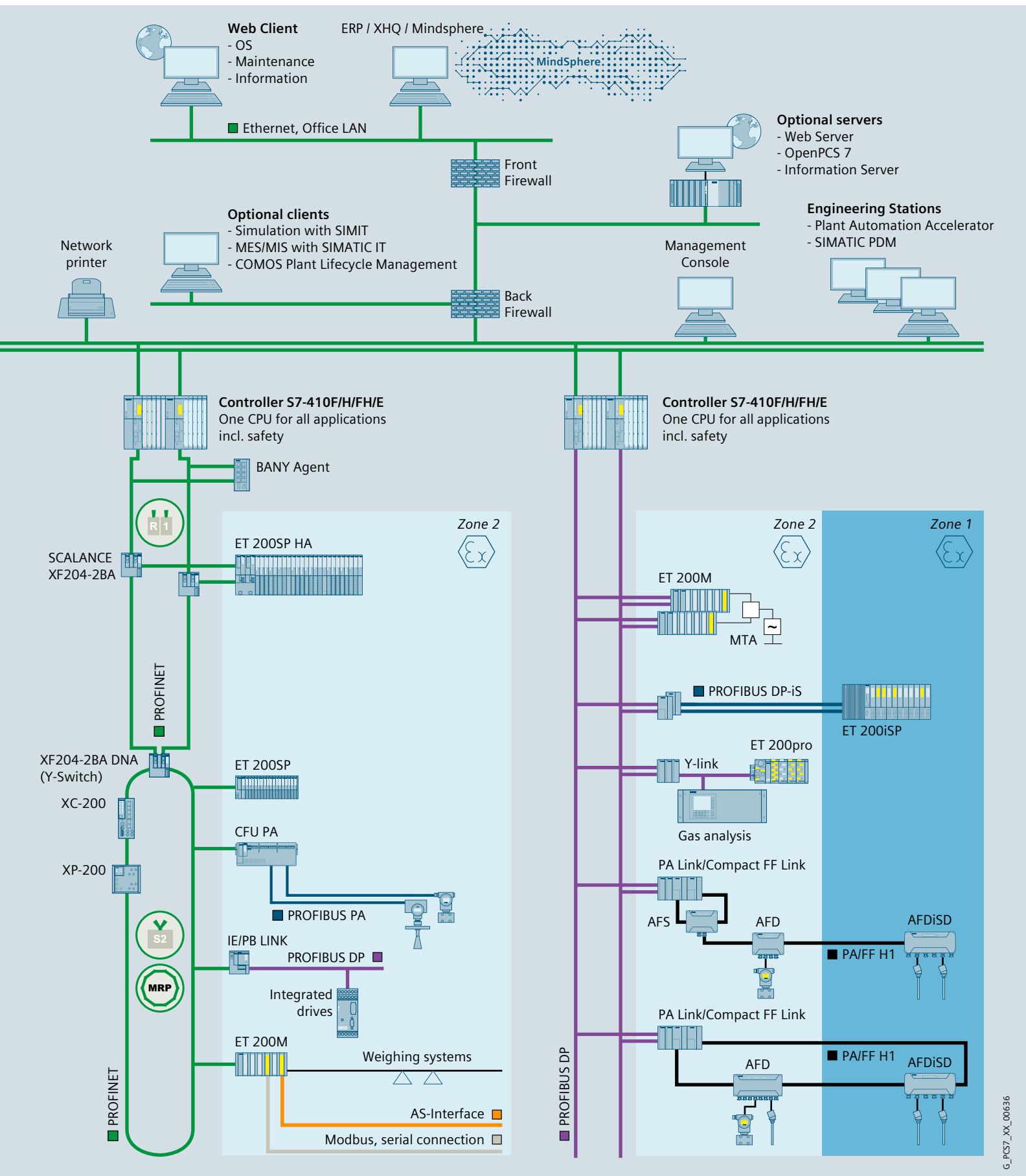

G_PCS7_XX_00636

Room for new perspectives with SIMATIC PCS 7

SIMATIC PCS 7 is one of the international leaders in process control systems, and has the potential to implement innovative solutions for the special challenges associated with the process industry. The functional diversity, flexibility, and performance of the SIMATIC PCS 7 pushes the limits of a typical process control system, and its technological enhancements offer many additional possibilities and new perspectives.

SIMATIC PCS 7 benefits from its seamless integration in Siemens Totally Integrated Automation (TIA), a complete range of matched products, systems, and solutions for all hierarchy levels of industrial automation - from the enterprise management level, to the control level, all the way down to the field level. This enables integrate, customized automation in all sectors of the process and hybrid industry.

An essential advantage of the consistency of the product and system spectrum and the solutions based upon this spectrum is that faster and more precise control sequences, as well as integrated security functions of shared hardware, engineering, and engineering tools can be used for automation of continuous and discontinuous processes.





More flexibility in process automation

In process plants, the process control system is the starting point for optimal value added: All procedures and processes can be operated, monitored and influenced with the process control system.

The higher the performance of the process control system, the more effectively this potential can be used. For this reason, performance is in the foreground with SIMATIC PCS 7, alongside scalability, flexibility and integration. Starting with planning and engineering, SIMATIC PCS 7 offers powerful tools, functions and features for cost-effective and efficient plant operation through all phases of the plant life cycle.

Flexibility through integration

Integration is one of the special strengths of SIMATIC PCS 7. It has numerous aspects:

- Horizontal integration into TIA
- Vertical integration into hierarchical communication
- System-integrated tools for engineering tasks
- Integration of the field level, including drives, switchgear, etc.
- Integrated functions, e.g. for batch process automation, route control, process safety, energy management, telecontrol tasks, etc.

Horizontal integration

A system for integrated automation of the entire process chain, from incoming raw materials to outgoing goods – this is one of the decisive advantages resulting from the seamless integration of SIMATIC PCS 7 into Totally Integrated Automation.

The process control system is mainly responsible for automating the primary processes here, but it can do very much more: All ancillary facilities such as the electrical infrastructure in the form of low-voltage or medium-voltage switchgear or the building management system, can also be integrated into the system.

Integration of selected SIMATIC standard components – automation systems, industrial PCs, network components, or distributed process I/O – into the process control system ensures optimum interaction, and secures economic benefits such as ease of selection, reduced stock keeping, and global support.

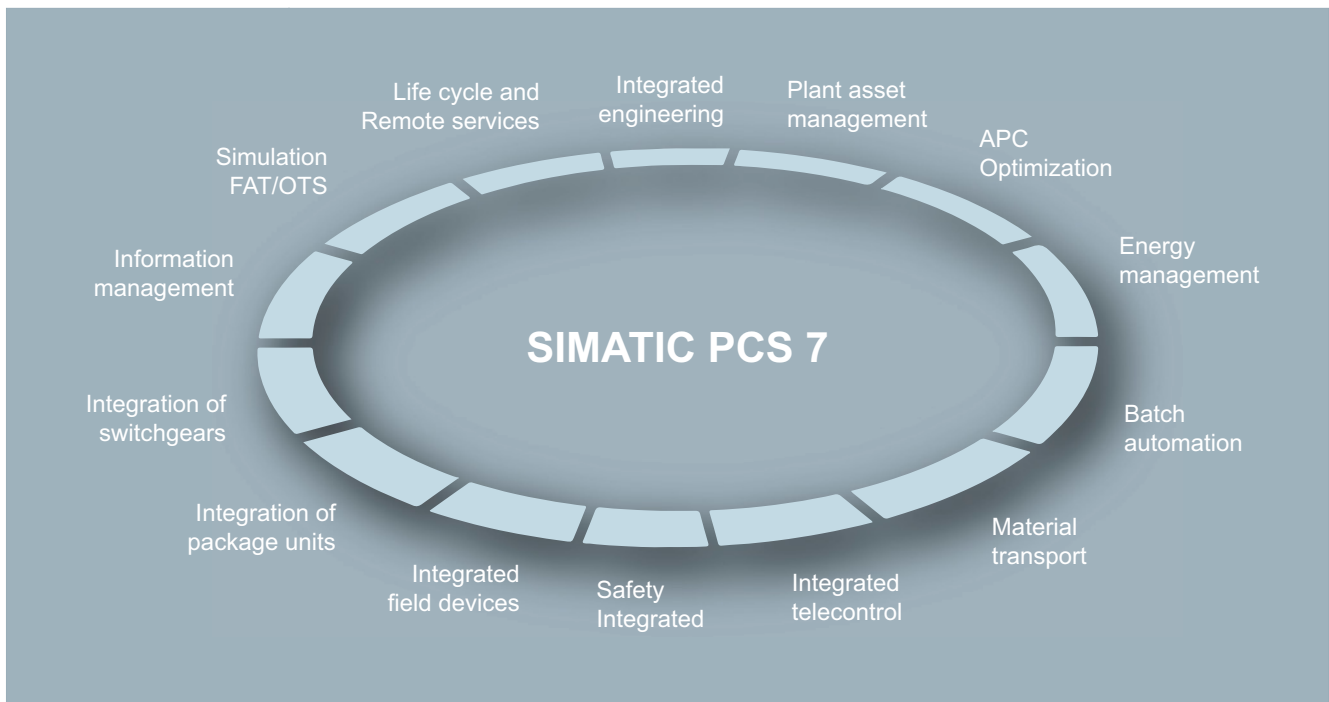

Vertical integration

The hierarchical communication of a company encompasses the field level, the control level and the process level, up to management and enterprise resource planning (ERP). Thanks to standardized interfaces – based on international industry standards as well as internal interfaces – SIMATIC PCS 7 is able to provide process data for analysis, planning, coordination, and optimization of plant sequences or production and business processes – in real time, and at any location in the company.

Central engineering

Impressive features of SIMATIC PCS 7 include graded functional diversity, consistent operator control philosophy and uniformly structured engineering and management tools. A central engineering system with a coordinated range of tools for integrated system engineering and configuring of batch automation, safety functions, material transport or telecontrol systems creates value added over the entire life cycle. Reductions in configuring and training costs minimize the total cost of ownership (TCO) over the entire plant life cycle.

Functional diversity

Depending on the typical process automation or customized requirements, the SIMATIC PCS 7 functions can be expanded by the following, for example:

- Batch process automation (SIMATIC BATCH)
- Functional safety and protection functions (Safety Integrated for Process Automation)
- Route control for material transport (SIMATIC Route Control)
- Telecontrol of remote units (SIMATIC PCS 7 TeleControl)
- Automation of electrical switchgear (SIMATIC PCS 7 PowerControl)

Further additional functions that are also integrated or can be integrated, seamlessly into the control system make optimization of processes and reductions in operating costs possible. SIMATIC PCS 7 features, for example, tools for energy and asset management and it offers higher quality closed-loop control functions, as well as industry-specific automation solutions and libraries.



Custom automation

Thanks to its unique scalable system architecture, SIMATIC PCS 7 provides the ideal basis for cost-effective implementation of individual automation solutions and economic operation of processes.

SIMATIC PCS 7 users derive sustained profit from a modular system platform based on standard SIMATIC components. Its uniformity enables flexible scaling of hardware and software, as well as perfect interaction both within the system and beyond system limits. The architecture of the SIMATIC PCS 7 Process Control System is designed in such a manner that instrumentation and control can be configured in accordance with customer requirements and optimally matched to the dimensions of the plant. The control system can be subsequently expanded or reconfigured at any time if there is an increase in capacity or a technological modification.

When the plant grows, SIMATIC PCS 7 simply grows along with it – without the provision of expensive reserve capacities!

Use the opportunities offered by the object-oriented type and instance concept of SIMATIC PCS 7. The technological connections, variant formation and bidirectional comparison of the types with the instances make the control module types (CMT) even more powerful compared to the original function block templates. The technological connections of a Control Module such as parameters, signals or messages can be provided with attributes and used via drag and drop, e.g. on an SFC plan. In turn, options and variants can be used to extend the core function of the CMT with specific modules or functions, which can be activated individually for each instance. This minimizes the number of types required and thus reduces the effort for maintenance and service. For the technological content of the CM types, the future-oriented Advanced Process Library (APL) is included in the standard of SIMATIC PCS 7. Another major advantage resulting from the comprehensive type and instance concept is the seamless integration into other tools like SIMATIC PCS 7 Plant Automation Accelerator or SIMATIC.

Flexibility and performance in engineering

The workflow in engineering for process plants is and remains a challenge: Multiple participants, many different data formats and multiple interfaces frequently result in transmission errors and system discontinuity and thus to greater time input and costs. Information generally gets lost or needs to be corrected manually when data exchanged between multiple disciplines.

For the first time, a fully integrated solution is now available for planning and documenting plant projects: the SIMATIC PCS 7 Plant Automation Accelerator. Customers benefit in particular from consistent engineering without system discontinuities between automation planning and the control system.

The object-based approach of the SIMATIC PCS 7 Plant Automation Accelerator allows you to work on a central data platform, ensuring fully integrated planning – from plant engineering through to automation – based on an electronic workflow.

This workflow ranges from planning to issuing offers, including bills of materials, the automatic generation of process control data for the SIMATIC PCS 7 process control system from electrical engineering, to controlled mass data engineering and direct as-in documentation of the plant. This modular engineering approach increases overall project efficiency and minimizes risks. High standardization and simple configuration also save time and costs in engineering during the implementation phase. Simple synchronization between planning and engineering avoids duplicate input and interface losses and reduces project runtimes.

Flexibility in operation

Process control is also becoming increasingly complex due to the multi-layer nature of automation engineering and increased merging with information technology. Intuitive and fault free operation is therefore more important than ever with regard to efficient working and the minimization of downtimes and servicing requirements. Using effective Advanced Process Control (APC) functions and an excellent operator system, SIMATIC PCS 7 supports both optimization and user-friendly, safe control of the process. Monitoring of product quality and performance indicators additionally allows the process to be operated more economically. SIMATIC PCS 7 excels with its flexibility, plant availability, and investment security.

Process control and maintenance

The SIMATIC PCS 7 operator system is used to monitor process operation using various views, and permits interventions when necessary. Its architecture is flexible and scalable – from single-user systems up to multi-user systems with a redundant client/server architecture. The operator interface takes account of the current specifications of NAMUR (user association of automation technology in the process industries) and PI (Profibus International) and offers a high level of user-friendliness for simple, intuitive interaction with the plant.



Ergonomic symbols, task-oriented faceplates, uniform representation of status information, and optimized alarm functions allow safe process control. The alarm management function integrated in SIMATIC PCS 7 is able to focus on essential alarms and to specifically guide the operator in exceptional circumstances. In this way, it systematically reduces the workload of operating staff.

Preventive and predictive maintenance strategies reduce total cost of ownership. With the SIMATIC PCS 7 Maintenance Station, maintenance personnel always have a watchful eye on critical production equipment such as pumps, valves, distillation columns or motors, and can carry out the relevant maintenance measures in good time before servicing is required – independent of the maintenance plan and without the risk of an unscheduled plant standstill.

Process optimization

SIMATIC PCS 7 supports process optimization in many different ways, including:

- Control Performance Monitoring
- Advanced Process Control
- Process Historian

The Control Performance Monitoring function monitors and signals the control quality of the closed-loop control block. If the performance declines, the controller can be optimized in good time or specific maintenance measures can be initiated.

The integrated I&C libraries of SIMATIC PCS 7 also provide higher quality closed-loop control functions with which cost-effective Advanced Process Control applications can be implemented: Multi-variable control, predictive control, or override control. It is thus possible to effectively improve profitability, product quality, safety, and environmental protection in small and medium-sized plants.

Current and historic process data form the basis of all optimization. Secure and user-friendly real-time data storage and analysis is handled using the Process Historian. The process values, messages, and batch data managed in the database of the Process Historian can be called extremely rapidly. User-specific processing and visualization of this historic data are supported by the information server, which is a reporting system based on the Microsoft Reporting Services.



SIMATIC PCS 7 V9.1

The new version of our established SIMATIC PCS 7 process control system is another building block for the digital enterprise.

SIMATIC PCS 7 V9.1 facilitates the route to digital transformation for the process industry – step by step. With its hardware and software innovations, the new version of our established process control system makes the step into digitalization even more secure and easier to plan.

SIMATIC PCS 7 is based wholly on PROFINET. The leading international Industrial Ethernet standard represents the high-performance real-time communication required in the era of big data, right into the field. Rapid, reliable, redundant and high-performance, PROFINET gives our customers new options for integrated diagnostics, monitoring and evaluation of their data. It also enables flexible and easily scalable network structures and enormous costs savings throughout the life cycle thanks to a huge reduction in cabling required.

These benefits are also reflected in the hardware innovations with SIMATIC PCS 7 V9.1:

The ultra-compact and high available new SIMATIC ET 200SP HA and SIMATIC CFU device lines support PROFINET – thus ensuring far greater freedom in plant planning and operation.

Of course, we all use digitization in our SIMATIC PCS 7 software innovations: our digital software portfolio and digital services for process automation therefore have and continue to be part an ongoing strategic development process, not least in the light of cloud applications.

The result: SIMATIC PCS 7 V9.1 offers our customers room for new perspectives – for greater flexibility in process automation.



SIMATIC PCS 7 system and technology components

With the rugged, high-performance **SIMATIC PCS 7 system components** from Catalog ST PCS 7, you already have a versatile platform for cost-effective implementation and economical operation of your process control systems. Perfect interplay of these system components makes it possible for you to sustain high-quality production and to establish new products significantly faster on the market.

With **SIMATIC PCS 7 technology components** from Catalog ST PCS 7 T that can be seamlessly integrated into the process control system, you can expand the functional scope of the system components in a carefully targeted manner for specific automation tasks.

This covers a wide spectrum, for example:

- Telecontrol for monitoring and controlling remote plant units
- Automation technology for electrical low-voltage or medium-voltage switchgear

- Industry-specific automation systems for the cement and mining industries, as well as for laboratory and training facilities
- Graphical objects for task-oriented optimization of process visualization
- Block libraries for technological functions, package unit and panel integration, monitoring and analyzing mechanical assets, as well as for building automation systems (heating, ventilation, air-conditioning – FMCS/HVAC)
- Editors and function blocks for the efficient configuration of small or medium-sized automation systems with simple parameter control and materials management
- Process analytical technology for quality assurance through optimization of development and production processes based on up-to-date measurements, and critical quality and performance attributes
- Simulation system for testing and commissioning of plant-specific application software

- Flexible, high-performance Manufacturing Execution System (MES)
- System expansion for operator systems for the integration of third-party controllers, programmable logic controllers and package units
- Products for migration of the process control systems APACS+/QUADLOG or Bailey INFI 90/NET 90 with SIMATIC PCS 7

SIMATIC PCS 7 technology components have been released for all versions and service packs of SIMATIC PCS 7 system components. The development and testing of SIMATIC PCS 7 technology components are dependent on the corresponding SIMATIC PCS 7 system components, so versioning and release is normally offset by approximately 3 to 6 months.

Additional functionality can be integrated using add-on products

Modularity, flexibility, scalability, and the openness of SIMATIC PCS 7 offer optimal prerequisites for integrating supplementary components and solutions in the process control system in an applicative manner and thus extend and round off its functionality.

Many supplementary add-on products for SIMATIC PCS 7 have been developed by Siemens as well as by external partners (see Catalog ST PCS 7, Add-ons for the SIMATIC PCS 7 Process Control System). These software packages and hardware components authorized by the system manufacturer enable cost-effective implementation of SIMATIC PCS 7 for special automation tasks.

Software Media and Logistics



1/2	PCS 7 software packages
1/4	Software Update Service
1/7	System documentation

SIMATIC PCS 7 system software

Software Media and Logistics

PCS 7 software packages

1

Design

Product categories for SIMATIC PCS 7 software

Generally, the SIMATIC PCS 7 and TIA software products offered in Catalog ST PCS 7 can be categorized as follows:

- **Core products** (single, floating or rental license) with
 - Installation Software (software media package)
 - License key for software licensing
- **Secondary products** (single, floating or rental license) with
 - License key for licensing of installation software is delivered with a core product or supplied separately
- **Cumulative volume licenses (quantity options)** with
 - License keys for a specific license volume in the form of process objects (POs), archive tags, TAGs, agents, clients, sources or units

All software products categorized in this way are available as packages. As an alternative to this physical form of delivery, the installation software and the software and volume licenses are often available online as well.

The available forms of delivery for each product are explicitly specified in the ordering data and identified by different article numbers.

Goods delivery

The products are delivered in a form and package suitable for parcel shipping by conventional means of transportation (e.g. shipped by truck, rail or air) to the shipping address of the customer.

The installation software (software media packages) and product-specific software licenses for the following products are separate packages, which are not merged into a single delivery unit when supplied in package form:

- SIMATIC PCS 7 core products (installation software provided as SIMATIC PCS 7 Software Media Package or SIMATIC PCS 7 Software Media Package ASIA)
- SIMATIC PDM, SIMATIC S7 F Systems and SIMATIC S7 Safety Matrix (installation software provided as product-specific software media package)

The installation software (software media package) is provided once for each ordered item for these products. When ordering more than one item, you can influence the number of software media packages using the order item. For example, if you order three SIMATIC PCS 7 OS Software Single Station software products as a single ordered item, you will receive only one software media package. However, if your order is divided into three ordered items, you will receive a software media package for each of the three software licenses.

Additional software media packages and volume licenses specified for the corresponding product can be ordered separately depending on the requirement.

The following table illustrates these ordering and delivery logistics:

Order				Product package	
Item No.	Quantity	Product name	Article No.	Quantity	Components
Ordering of 3 units with one order item					
010	3	SIMATIC PCS 7 OS Software Single Station V9.1 incl. 100 OS Runtime PO	6ES7658-2AA68-0YA0	3	License key USB flash drive, Certificate of License
				1	SIMATIC PCS 7 Software Media Package
Ordering of 3 units with three order items					
010	1	SIMATIC PCS 7 OS Software Single Station V9.1 incl. 100 OS Runtime PO	6ES7658-2AA68-0YA0	1	License key USB flash drive, Certificate of License
				1	SIMATIC PCS 7 Software Media Package
020	1	SIMATIC PCS 7 OS Software Single Station V9.1 incl. 100 OS Runtime PO	6ES7658-2AA68-0YA0	1	License key USB flash drive, Certificate of License
				1	SIMATIC PCS 7 Software Media Package
030	1	SIMATIC PCS 7 OS Software Single Station V9.1 incl. 100 OS Runtime PO	6ES7658-2AA68-0YA0	1	License key USB flash drive, Certificate of License
				1	SIMATIC PCS 7 Software Media Package

These ordering and delivery logistics are not relevant for products that are typically supplied without a software media package. They include:

- Secondary products
- Core products with rental license
- Client software

Design (continued)

Online delivery

We offer online delivery for SIMATIC PCS 7 software and license keys via the Internet as an innovative alternative to the delivery of goods. The decisive advantage over the delivery of goods lies in the fact that the software and licenses are available immediately and are easier to manage.

The software products and licenses that can be downloaded have different article numbers. They are ordered through the normal channels, e.g. the Industry Mall.

When ordering via the Industry Mall, you can filter out the ordering data of those products that can be delivered online with reference to the selected branch of the product and offering tree. This can be done by selecting "Online delivery" from a drop-down list on the right of the screen. This way you will achieve a better overview of the online offering.

When ordering a product that can be delivered online, the email address of the ship-to party must be provided. The recipient of the goods is informed by email as soon as the ordered products are available for downloading. The email message with the availability information also contains the login data. Parallel delivery on a data storage medium does not take place.

The software, license key and associated documents, e.g. the online Certificate of License (eCoL), are downloaded in the Automation License Manager (ALM). A license key can be downloaded once only. To log in, the login data received in the email is required. As an alternative, the access data to the Industry Mall account can be used for logging in.

Apart from the download, ALM also supports license management. You can, for example, get an overview of the available licenses or those obtained online, allocate licenses, and run a hardware-specific license analysis.

Ordering data

Article No.

SIMATIC PCS 7 Software Media Packages

Runs with the following operating systems (see SIMATIC PCS 7 Readme and the product licenses for more details):

- Windows 10 Enterprise 2019 LTS
- Windows Server 2019 Standard Edition

SIMATIC PCS 7 Software Media Package V9.1¹⁾

Installation software and electronic documentation on USB flash drive, incl. Trial License for 14 days

5 languages (English, German, French, Italian, Spanish), software class A

- Goods delivery
USB flash drive, Certificate of License
- Online delivery
Software download, online Certificate of License
Note: Email address required!

6ES7658-4XX68-0YT8

6ES7658-4XX68-0YG8

SIMATIC PCS 7 Software Media Package ASIA V9.1¹⁾

Installation software and electronic documentation on USB flash drive, incl. Trial License for 14 days

2 languages (English, Chinese), software class A

- Goods delivery
USB flash drive, Certificate of License

6ES7658-4XX68-0CT8

¹⁾ Permanent use of SIMATIC PCS 7 software requires valid software licenses.

More information

Regional product versions

All SIMATIC PCS 7 software products are designed for international use, in other words there is only one product version for worldwide use and this is offered in up to 6 languages: English, German, French, Italian, Spanish and Chinese. However, the number of supported languages is not standard; it can vary from product to product.

In addition, a regional "ASIA" product version will also be offered for the SIMATIC PCS 7 Software Media Package and specific SIMATIC PCS 7 software products of the "Engineering System" and "Operator System" system components. The ASIA products are available in two languages: English and Chinese (simplified). They are explicitly identified in the name by the suffix "ASIA".

If a product listed in this catalog does not have the suffix "ASIA" in its name, it can always be used globally. However, the following restriction applies: If a regional ASIA product is offered, the pendant for international use does not support the Asian languages (currently Chinese simplified) present in the ASIA product.

The products for international use, i.e. products without the suffix "ASIA", are not intended as the basis for runtime systems with fonts in Asian languages.

The following special points must be observed as a result of the definition of separate products for installation software and licenses. The SIMATIC PCS 7 installation software is available in the form of two data medium packages:

- SIMATIC PCS 7 Software Media Package
- SIMATIC PCS 7 Software Media Package ASIA

The specific ASIA software licenses harmonize exclusively with the SIMATIC PCS 7 Software Media Package ASIA. SIMATIC PCS 7 software licenses for which there is no ASIA pendant can be used with both SIMATIC PCS 7 Software Media Packages.

SIMATIC PCS 7 system software

Software Media and Logistics

Software Update Service

1

Overview

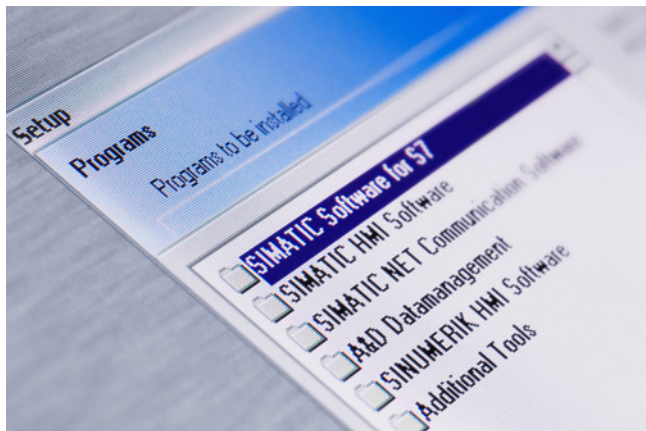

Software Update Service for SIMATIC PCS 7

Siemens offers a cost-effective Software Update Service (SUS) for international SIMATIC PCS 7 software products (except for specially marked regional versions, such as products with the "ASIA" label). If you utilize this service, you participate in the further development of the SIMATIC PCS 7 software you are using, and are always in possession of the latest release versions. You can join the Software Update Service for SIMATIC PCS 7 by purchasing SUS packages, and this is only possible on the basis of the current software versions at the time of purchase.

The SUS packages represent a structural division of the SIMATIC PCS 7 software product range using functional and system-specific aspects. The number and composition of the package components identified as **list elements** depend mainly on license aspects. A list element can represent a single software product or be a synonym for several products of the same type, [see page 1/5](#)

When purchasing **one** SUS package, you automatically receive all upgrades and ServicePacks for the software referred to in this package for one year. Within this period of one year, you are therefore authorized to update **one** corresponding license from your stock for **each** list element in this package. The total number of SUS packages of one type which you require is therefore determined by the list element which includes most of the software licenses you use.

An example of the SUS OS Server package should make this clear once again based on a fictitious license inventory:

Software products in inventory	License inventory	License inventory per list item	Number of SUS packages
• 3 × PCS 7 AS/OS Engineering Software	3	4	4
1 × PCS 7 AS Engineering Software	1		
• 1 × Version Cross Manager	1	1	
• 3 × PCS 7 SFC Visualization	3	3	

For a list item that represents several products, existing licenses of these products are to be added in the inventory first. In the example, these are the licenses of the "PCS 7 AS/OS? Engineering Software" and "PCS 7 AS Engineering Software" for the first list element of the SUS Engineering AS/OS.

The license inventory is defined by a single product for the other list items. The list item that combines the most licenses is ultimately decisive in determining the number of required SUS packages. Based on the example, you would therefore need to order 4 SUS Engineering AS/OS packages.

Duration of subscription, cancellation

Delivery is to the address entered in the order. An SUS is automatically extended for a further year unless canceled no later than 3 months prior to expiration. Cancellation must be made in writing, and must be sent to the dispatch center with reference to the contract number or can be made using the SUS Manager (<http://www.siemens.com/susmanager>).

SUS editions

SUS packages are available as:

- SUS package
- SUS Compact
- SUS Download

SUS package is the most comprehensive package form. If you order this package n times, you will receive n number of packing units.

Each of these packing units contains

- Initial delivery: 1 Certificate of Contract
- Upgrade delivery: 1 data storage medium set, 1 license key USB flash drive with **one** license

SUS Compact reduces the scope of the package for the Software Update Service for multiple workstations and simplifies the central management of licenses.

If you order SUS Compact n times, you will receive only one packing unit. This packing unit contains

- Initial delivery: n Certificates of Contract
- Upgrade delivery: 1 data storage medium set, 1 license key USB flash drive with **n** licenses

SUS Compact is offered for the following SIMATIC PCS 7 SUS packages:

- SUS OS Single Station
- SUS OS Server
- SUS OS Client, SFC Visualization
- SUS SIMATIC BATCH Server/Single Station
- SUS SIMATIC BATCH Client

SUS Download, which is delivered over the Internet, has the advantage that software and licenses are available more rapidly than with goods delivery, and can also be managed more easily.

A recipient email address is required for delivery of SUS Download. An order item can only be assigned to a single email address. The consignee is informed by email as soon as the Certificates of Contract or the software and licenses are available for downloading.

Downloading of software, license keys, and associated documents is carried out in the Automation License Manager (ALM).

SUS Manager

It is easy to manage SUS contracts, e.g. change the delivery form, with the SUS Manager:

<http://www.siemens.com/susmanager>

Overview (continued)

The following table uses an example to clarify the differences between the SUS editions:

Edition	SUS package	SUS Compact	SUS Download
Type of delivery	Goods delivery	Goods delivery	Online delivery
Order	25 × SUS package in one order item	25 × SUS Compact in one order item	25 × SUS Download in one order item
First delivery	25 packing units with: • 1 × Certificate of Contract (CoC)	1 packing unit with: • 25 × Certificate of Contract (CoC)	1 email message for • 25 × Online Certificate of Contract (ECoC)
Subsequent delivery of Service Packs	25 × Service Pack (data storage medium set)	1 × Service Pack (data storage medium set)	1 × Service Pack (download)
Subsequent delivery of upgrades	25 packing units with: • 1 × data storage medium set • 1 × license key USB flash drive with 1 license • 1 × Certificate of License (CoL)	1 packing unit with: • 1 × data storage medium set • 1 × license key USB flash drive with 25 licenses • 25 × Certificate of License (CoL)	1 email message for • Software download • 1 × license key download for 25 licenses • 1 × online Certificate of License for 25 CoL (zip file)
Billing	1 bill	1 bill	1 bill

If a comparable product exists in a different edition for an existing SUS package, the existing SUS contract can be modified accordingly if required.

Software Update Service for TIA products

In addition to the SUS for the SIMATIC PCS 7 process control system, there is also the SUS for SIMATIC PCS 7 products used

in a different context (CFC, SIMATIC PDM) within the scope of Totally Integrated Automation (TIA). The SIMATIC PDM packages SUS PDM Basic und SUS PDM Complete are identical for both cases.

The SUS for SIMATIC S7 products that are used in the context of SIMATIC PCS 7, e.g. SUS S7-PLCSIM, round out the SUS offer.

Design**Structure and content of the SUS packages for the SIMATIC PCS 7 Software Update Service**

Note:

Each item of an SUS package (element in list) represents a software license.

SUS Engineering AS/OS	<ul style="list-style-type: none"> PCS 7 AS/OS Engineering Software, PCS 7 AS Engineering Software PCS 7 ES Single Station (AS/OS: 250 POs) PCS 7 Management Console PCS 7 Import-Export Assistant Version Cross Manager Version Trail PCS 7 SFC Visualization PCS 7 BCE IE S7 license for communication via CP 1623/CP 1628 	SUS Process Historian, Information Server	<ul style="list-style-type: none"> PCS 7 Process Historian Basic Package, PCS 7 Process Historian Redundancy (for one server) PCS 7 Process Historian and Information Server Basic Package PCS 7 Process Historian Archive BATCH PCS 7 Process Historian OPC UA Server PCS 7 Information Server Basic Package
SUS OS Client, SFC Visualization	<ul style="list-style-type: none"> PCS 7 OS Software Client PCS 7 SFC Visualization 	SUS OS Client, SFC Visualization	<ul style="list-style-type: none"> PCS 7 OS Software Client PCS 7 SFC Visualization
SUS Web Server	<ul style="list-style-type: none"> PCS 7 Web Server PCS 7 Web Diagnostics Server PCS 7 Web Diagnostics Client 	SUS Web Server	<ul style="list-style-type: none"> PCS 7 Web Server PCS 7 Web Diagnostics Server PCS 7 Web Diagnostics Client
SUS Logic Matrix	<ul style="list-style-type: none"> PCS 7 Logic Matrix Viewer 	SUS Maintenance Station	<ul style="list-style-type: none"> PCS 7 Maintenance Station Engineering PCS 7 Maintenance Station Runtime Basic Package PCS 7 OS Software Client
SUS PDM Basic¹⁾	<ul style="list-style-type: none"> PDM Basic PDM Service PDM S7 PDM PCS 7 PDM HART Server 	SUS SIMATIC BATCH Server/Single Station	<ul style="list-style-type: none"> PCS 7 SIMATIC BATCH Server PCS 7 SIMATIC BATCH Single Station Package PCS 7 SIMATIC BATCH Basic PCS 7 SIMATIC BATCH API PCS 7 BCE IE S7 license for communication via CP 1623/CP 1628
SUS PDM Complete¹⁾	<ul style="list-style-type: none"> PDM stand-alone server PDM PCS 7 server PDM PCS 7-FF PDM HART Server 	SUS SIMATIC BATCH Client	<ul style="list-style-type: none"> PCS 7 SIMATIC BATCH Client PCS 7 SIMATIC BATCH Recipe System
SUS OS single station (2 SUS packages are required for a redundant pair)	<ul style="list-style-type: none"> PCS 7 OS Software Single Station, PCS 7 OS Software Single Station Redundancy (for one single station) PCS 7 OpenPCS 7/OS Client PCS 7 OpenPCS 7 PCS 7 SFC Visualization PCS 7 BCE IE S7 license for communication via CP 1623/CP 1628 	SUS SIMATIC Route Control	<ul style="list-style-type: none"> PCS 7 SIMATIC Route Control Engineering PCS 7 SIMATIC Route Control Center PCS 7 SIMATIC Route Control Server PCS 7 BCE IE S7 license for communication via CP 1623/CP 1628
SUS OS server (2 SUS packages are required for a redundant pair)	<ul style="list-style-type: none"> PCS 7 OS Software Server, PCS 7 OS Software Server Redundancy (for one server) PCS 7 OpenPCS 7/OS Client PCS 7 OpenPCS 7 PCS 7 SFC Visualization PCS 7 BCE IE S7 license for communication via CP 1623/CP 1628 		

¹⁾ Optional product components for SIMATIC PDM such as PDM Extended, PDM Integration in STEP 7/PCS 7, PDM Routing, PDM Server and PDM Communication FOUNDATION Fieldbus are each included in a product package listed in the SUS PDM Basic or SUS PDM Complete and are implicitly authorized to be updated via the corresponding license. You need to change from SUS PDM Basic to SUS PDM Complete to use the PDM Server or PDM Communication FOUNDATION Fieldbus product components.

SIMATIC PCS 7 system software

Software Media and Logistics

Software Update Service

1

Ordering data

Article No.

SUS package

SIMATIC PCS 7 Software Update Service, package

Subscription for 1 year with automatic extension; requirement: Current software version; goods delivery

- PCS 7 Software Update Service for Engineering AS/OS
- PCS 7 Software Update Service Logic Matrix
- PCS 7 Software Update Service for OS Single Station
- PCS 7 Software Update Service for OS Server
- PCS 7 Software Update Service Process Historian, Information Server
- PCS 7 Software Update Service for OS Client, SFC Visualization
- PCS 7 Software Update Service for Web Server
- PCS 7 Software Update Service for Maintenance Station
- PCS 7 Software Update Service for SIMATIC BATCH Server/Single Station
- PCS 7 Software Update Service for SIMATIC BATCH Client
- PCS 7 Software Update Service for SIMATIC Route Control

6ES7658-1XX00-0YL8

6ES7658-1JX00-0YL8

6ES7658-2AX00-0YL8

6ES7658-2BX00-0YL8

6ES7652-7XX00-0YL8

6ES7658-2CX00-0YL8

6ES7658-2GX00-2YL8

6ES7658-7GX00-0YL8

6ES7657-0SA00-0YL8

6ES7657-0XX00-2YL8

6ES7658-7DX00-0YL8

Software Update Service for TIA products, package

(SIMATIC PCS 7 products used in a different context, as well as SIMATIC S7 products used with SIMATIC PCS 7)

Subscription for 1 year with automatic extension; requirement: current software version

- SIMATIC PDM Basic Software Update Service
- SIMATIC PDM Complete Software Update Service
- S7-PLCSIM Software Update Service

6ES7658-3XX01-0YL8

6ES7658-3XX02-0YL8

6ES7841-0CA01-0YX2

Article No.

SUS Compact

SIMATIC PCS 7 Software Update Service, Compact

Subscription for 1 year with automatic extension; requirement: Current software version; goods delivery

- PCS 7 Software Update Service for OS Single Station
- PCS 7 Software Update Service for OS Server
- PCS 7 Software Update Service for OS Client, SFC Visualization
- PCS 7 Software Update Service for SIMATIC BATCH Server/Single Station
- PCS 7 Software Update Service for SIMATIC BATCH Client

6ES7658-2AX00-0YM8

6ES7658-2BX00-0YM8

6ES7658-2CX00-0YM8

6ES7657-0SA00-0YM8

6ES7657-0XX00-2YM8

SUS Download

SIMATIC PCS 7 Software Update Service, Download

Subscription for 1 year with automatic extension; requirement: current software version; delivery form: online

Note: Email address required!

- PCS 7 Software Update Service for Engineering AS/OS
- PCS 7 Software Update Service for OS Single Station
- PCS 7 Software Update Service for OS Server
- PCS 7 Software Update Service Process Historian, Information Server
- PCS 7 Software Update Service for OS Client, SFC Visualization
- PCS 7 Software Update Service for Web Server
- PCS 7 Software Update Service for Maintenance Station
- PCS 7 Software Update Service for SIMATIC BATCH Server/Single Station
- PCS 7 Software Update Service for SIMATIC BATCH Client
- PCS 7 Software Update Service for SIMATIC Route Control
- SIMATIC PDM Basic Software Update Service
- SIMATIC PDM Complete Software Update Service

6ES7658-1XX00-0YV8

6ES7658-2AX00-0YV8

6ES7658-2BX00-0YV8

6ES7652-7XX00-0YV8

6ES7658-2CX00-0YV8

6ES7658-2GX00-2YV8

6ES7658-7GX00-0YV8

6ES7657-0SA00-0YV8

6ES7657-0XX00-2YV8

6ES7658-7DX00-0YV8

6ES7658-3XX01-0YV8

6ES7658-3XX02-0YV8

Overview

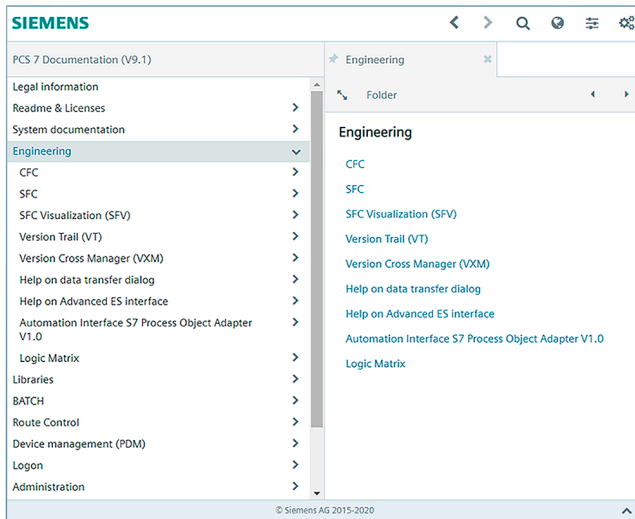

PCS 7 online help is supplied with SIMATIC PCS 7. This is made available in the Plant and User Documentation Manager, a modern content delivery portal. It can be accessed via the Desktop as well as via the SIMATIC Manager. It is possible to add additional SIMATIC PCS 7 documents to the provided documentation specific to the user.

The SIMATIC PCS 7 documentation is provided free of charge and in multilingual form on the Internet via the **My Documentation Manager**.

My Documentation Manager not only enables you to view documents, you can also collect them in your own library and generate your own documents. Information about using these functions as well as FAQs are available in My Documentation Manager.

The SIMATIC PCS 7 system documentation provides both beginners and experienced users with valuable information on all aspects of the process control system. The range extends from the system introduction, covers initial steps and cross-system topics, up to a description of individual system components. With the "Getting Started" documentation you can gain initial practical experience using example projects.

In order to use this, select the manuals for your SIMATIC PCS 7 version on the website for SIMATIC PCS 7 technical documentation:

<http://www.siemens.com/pcs7-documentation>

You can open the available SIMATIC PCS 7 manuals directly in the My Documentation Manager, or first start the My Documentation Manager and then select the desired documentation in the integrated Siemens library.

In addition to the SIMATIC PCS 7 system documentation, the Siemens library in the My Documentation Manager provides access to the technical documentation of other products and systems from the SIMATIC range of products.

Latest information on SIMATIC PCS 7 in the Readme file

The PCS 7 online Readme files can also be opened at the Internet address provided above. There you will find information on the approved operating systems for PCS 7 software, for example. On the "Technical Documentation SIMATIC PCS 7" page, select "Software Manuals SIMATIC PCS 7 V9.1". All PCS 7 Readme files in Siemens Industry Online Support can be opened on the following page.

More information

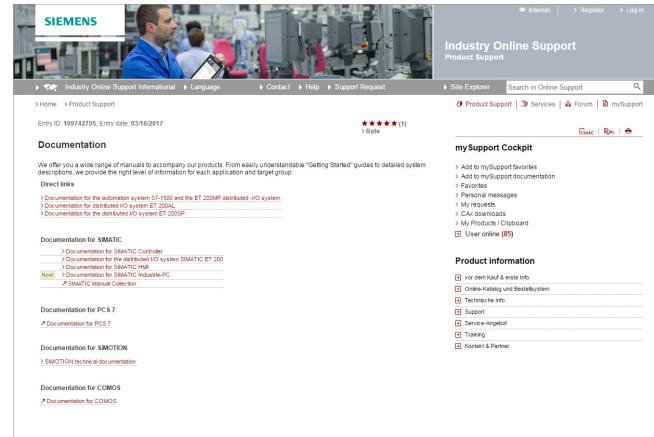

The "SIMATIC documentation" page site in Siemens Industry Online Support directs you straight to the complete range of technical documentation available for SIMATIC products and systems. You can select individual documents from this range for viewing or downloading.

Additional information is available on the Internet at:

<http://www.siemens.com/simatic-docu>

SIMATIC PCS 7 system software

Notes

1

System administration

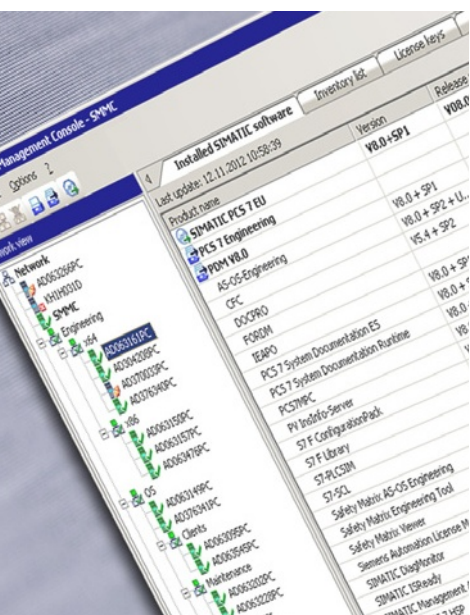

2/2

Management Console

SIMATIC PCS 7 system software

System administration

Management Console

Overview

2

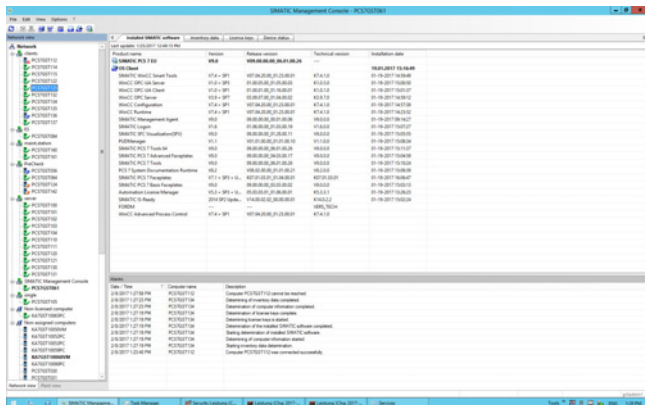

SIMATIC Management Console: Overview of installed software status

A process control system includes numerous heterogeneous components with specific parameters and settings. It is also subject to a dynamic change process due to updates, upgrades as well as modernization measures and expansion. As the plant gets older, it becomes more difficult for you to keep track of the current state of hardware and software. What is more, establishing and maintaining transparency without system support is very time-consuming.

The SIMATIC PCS 7 Management Console enables you to reduce the work for managing your SIMATIC PCS 7 plant to a minimum. You also have the latest status of the installed hardware and software components immediately at hand.

SIMATIC PCS 7 Management Console enables:

- Centralized, standardized administration of SIMATIC PCS 7 software
- Inventory of all installed hardware and software components of the SIMATIC PCS 7 plant

Design

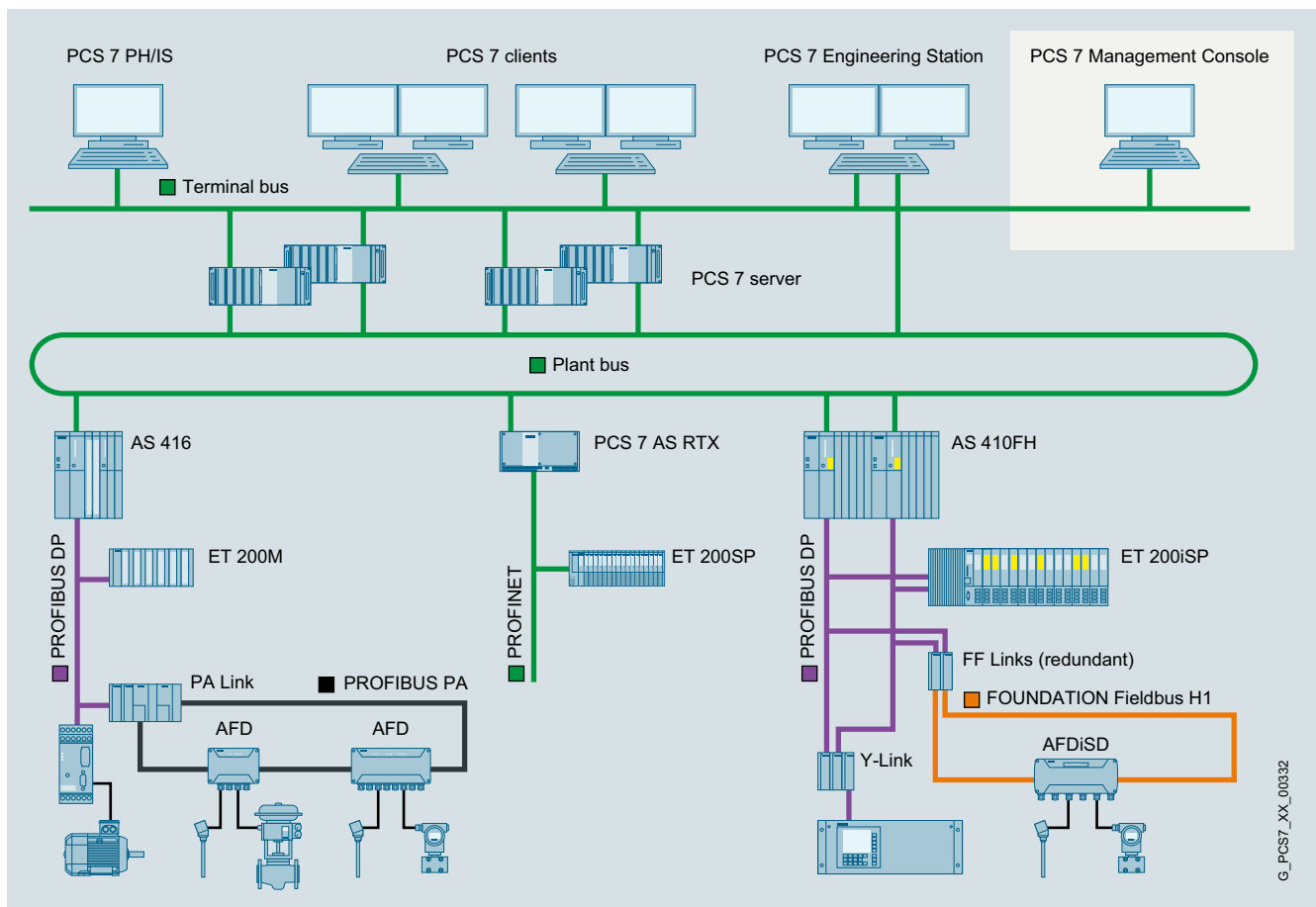

Example of a SIMATIC PCS 7 plant with a stand-alone SIMATIC PCS 7 Management Console

G_PCS7_XX_00332

Design (continued)

The SIMATIC PCS 7 Management Console enables you to manage either individual SIMATIC PCS 7 plants or multiple plants of a SIMATIC PCS 7 plant network.

For small and medium-sized SIMATIC PCS 7 plants with up to 25 workstations, the SIMATIC PCS 7 Management Console can be installed and operated on a SIMATIC PCS 7 engineering station.

For medium-sized and large SIMATIC PCS 7 plants and SIMATIC PCS 7 plant networks with a total of more than 25 workstations, however, we recommend a stand-alone SIMATIC PCS 7 Management Console. For the single-station or server versions of SIMATIC PCS 7 Industrial Workstation that are suitable as the basic hardware for such an exclusive SIMATIC PCS 7 Management Console, see "Industrial Workstation/IPC".

The central SIMATIC PCS 7 Management Console communicates with "agents" on the relevant SIMATIC PCS 7 Industrial Workstations in a SIMATIC PCS 7 plant. These Management Console agents run local SIMATIC PCS 7 Management Console jobs and return the results.

Secure authentication of communication between the SIMATIC PCS 7 Management Console and the Management Console agents is ensured by the Kerberos protocol.

Note:

A reduced range of services of the Management Console, which enables inventory, can be used without licenses. To make use of the full scope of performance of the Management Console, in addition to a "SIMATIC PCS 7 Management Console" license an additional "Management Console Agent" license is required for each SIMATIC PCS 7 Industrial Workstation managed using Management Console. The Management Console Agents are available in cumulative sets with 10, 50 and 100 licenses. Unlimited use of the system inventory function is possible even without licenses.

Function

Central administration of SIMATIC PCS 7 software

The central administration of the software versions of all stations of a SIMATIC PCS 7 system significantly reduces the administrative effort. SIMATIC PCS 7 installations, updates and Service Packs are subject to administration. In addition to the current SIMATIC PCS 7 software version, upgrades to the current software version are supported. The software can be installed on an individual target station or on multiple target stations in parallel using setup packages. The installation on the target station does not require active participation of the user. Thanks to the upstream security mechanisms, unintended adverse effects on runtime operation can be prevented.

Setup management

- Provision of SIMATIC PCS 7 installation files on a dedicated file server or combined on the SIMATIC PCS 7 Management Console
- Addition/removal of SIMATIC PCS 7 setups in the central setup management of the SIMATIC PCS 7 Management Console
- Creation of pre-configured setup packages based on plant/user-specific aspects (e.g. OS Client package)
- Display and editing of SIMATIC PCS 7 setups and setup packages for preparing for installation
- Rollout of pre-configured setup packages to target stations
 - Addition of software packages during installation
 - Editing of setups or setup packages

Status monitoring of the target stations

- Check of target stations for installation readiness by determining and displaying the operating state or role (e.g. OS runtime active/inactive, redundancy mode)
- Implicit, remote disabling of a station in preparation for the start of a SIMATIC PCS 7 update installation
- Status monitoring of the entire SIMATIC PCS 7 installation (e.g. resumption of the installation after restart or network interruption)
- Implicit, remote enabling of a station after completion of a SIMATIC PCS 7 update installation

Installation of Microsoft software updates

Provided there is an existing connection to a Microsoft WSUS that provides Microsoft software updates, the Management Console supports the central installation of Microsoft software updates on all administered computers. Comparable to the rollout of SIMATIC PCS 7 software, the updates can be installed on individual computers or on several computers simultaneously in parallel.

SIMATIC PCS 7 system software

System administration

Management Console

Function (continued)

SIMATIC PCS 7 system inventory

General inventory taking of installed hardware and software components from a central location offers the following advantages, for example:

- Quick analysis of the installed components as preparation for replacement actions or upgrades
- Simple creation of a detailed inventory report

The SIMATIC PCS 7 system inventory spans all levels of a SIMATIC PCS 7 system (management level, control level, field level). It covers SIMATIC PCS 7 system components in the named levels, e.g. SIMATIC PCS 7 workstations, Industrial Ethernet switches, automation systems (controllers), remote I/Os, links, field devices, drives, etc. For the AS 410 automation systems configured in the SIMATIC PCS 7 system, the number of available and used process objects is also determined in the inventory.

SIMATIC PCS 7 system inventory includes:

- Central acquisition of inventory data by reading it from the database of the SIMATIC PCS 7 engineering system or directly from the components
- Generation of an inventory report in Microsoft Excel format
 - Combination of filter results with user-defined categories
 - Colored marking of filtered data
- Generation of an inventory report in iBase format
 - Upload of inventory data to the central database for Service and Support
- Comparison with the latest software version
- Comparison with the latest hardware and firmware version
- Creation of a license certificate in the form of a list of installed software licenses and their uses

Ordering data

Article No.

SIMATIC PCS 7 Management Console V9.1

5 languages (English, German, French, Italian, Spanish), software class A, runs with Windows 10 Enterprise 2019 LTSC and Windows Server 2019 Standard Edition 64-bit (see SIMATIC PCS 7 Readme for the latest information¹⁾), single license for 1 installation

Without SIMATIC PCS 7 Software Media Package

- Goods delivery
License key on USB flash drive, Certificate of License
- Online delivery
License key download, online Certificate of License
Note: Email address required!

6ES7658-5BX68-2YB5

6ES7658-5BX68-2YH5

Management Console Agents²⁾

Independent of language, software class A, floating license for 1 user

Without SIMATIC PCS 7 Software Media Package

- Goods delivery
License key on USB flash drive, Certificate of License
 - 10 agents
 - 50 agents
 - 100 agents
- Online delivery
License key download, online Certificate of License
Note: Email address required!
 - 10 agents
 - 50 agents
 - 100 agents

6ES7658-5BA00-2YB5

6ES7658-5BB00-2YB5

6ES7658-5BC00-2YB5

6ES7658-5BA00-2YH5

6ES7658-5BB00-2YH5

6ES7658-5BC00-2YH5

¹⁾ See "Software Media and Logistics" section, under "System documentation", see page 1/7

²⁾ An agent is required for each SIMATIC PCS 7 Industrial Workstation managed by the Management Console.

Engineering system



3/2	Introduction
3/3	ES software
3/4	Standard engineering software
3/13	SIMATIC PCS 7 Logic Matrix
3/14	SIMATIC Version Cross Manager
3/15	Version Trail
3/16	Import/Export Assistant
3/17	Simulation
3/17	Simulation with S7-PLCSIM
3/18	SIMIT Simulation
3/18	– SIMIT Simulation Platform
3/24	– SIMIT Unit
3/26	– Virtual Controller

SIMATIC PCS 7 system software

Engineering system

Introduction

Overview

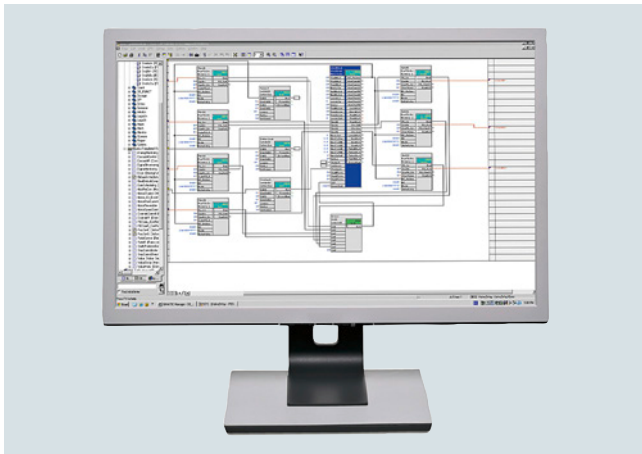

The engineering system of the SIMATIC PCS 7 process control system is based on the high-performance SIMATIC PCS7 Industrial Workstation, which can be used either in office applications or in industrial environments.

The engineering software run on this hardware can be optimally matched to different customer requirements and tasks. The basic functionality defined by the standard engineering software can be optionally expanded depending on the project-specific task and its implementation.

The software licenses provided for the engineering system can be used to configure two system variants for different applications areas:

- **Classic, dedicated engineering station**
allows in addition to engineering a 2-hour OS test mode, but no productive operation as an operator station
- **Combined engineering/operator station for small applications**
allows in addition to engineering also process control for small plants in productive operation

Design

The architecture of the engineering system depends on how the SIMATIC PCS 7 project is processed:

- Locally, on a central engineering station
- In the engineering network (concurrent engineering)

Central engineering station

Hardware platform for the central engineering station is the **SIMATIC PCS 7 Industrial Workstation for ES/OS single station**. This is based on a SIMATIC IPC of Rack PC design which is prepared for installation in 19" rack systems. Two versions are available for communication connection to the Industrial Ethernet plant bus:

- Communication over BCE
Connection to plant bus with 10/100/1000 Mbps RJ45 network adapter and Basic Communication Ethernet (BCE) for communication with up to 8 automation systems (no redundancy stations)
- Communication over Industrial Ethernet
Connection to plant bus with CP 1623/1628 communication module for communication with up to 64 automation systems

Two onboard 10/100/1000 Mbps Ethernet RJ45 ports are available for connecting to the terminal bus.

The Microsoft Windows 10 operating system and the SIMATIC PCS 7 engineering software for AS/OS are pre-installed on the SIMATIC PCS 7 Industrial Workstation on delivery. The scope of performance of the pre-installed SIMATIC PCS 7 engineering software is defined by installation of the purchased software licenses.

Engineering network

With concurrent engineering in an engineering network, the project is localized on one of the participating Engineering Stations, the "Project server". The engineering stations working as "project clients" can access the project server data over LAN/WAN. Every engineering station in the network (project server/client) is able to download configuration data to a SIMATIC PCS 7 subsystem provided it has the required communication connections.

In this architecture, it is sensible to install the project server on a **SIMATIC PCS 7 Industrial Workstation for OS servers**. The Microsoft Windows Server operating system and the SIMATIC PCS 7 OS Software server are pre-installed on this when delivered (adaptation/expansion of SIMATIC PCS 7 installation required).

Two versions are also available for the communication connection to the Industrial Ethernet plant bus with the SIMATIC PCS 7 Industrial Workstation for OS servers:

- Communication over BCE
Connection to plant bus with 10/100/1000 Mbps RJ45 network adapter and Basic Communication Ethernet (BCE) for communication with up to 8 automation systems (no redundancy stations)
- Communication over Industrial Ethernet
Connection to plant bus with CP 1623/1628 communication module for communication with up to 64 automation systems

With the SIMATIC PCS 7 Industrial Workstation for ES/OS single stations, you can use the same hardware platform for the project clients as for the central engineering station.

Configuration can be made easier by multi-monitor mode with up to 4 process monitors, both for a central engineering station and for individual stations in an engineering network.

See section "Industrial Workstation/IPC" for ordering data and detailed information on the product package and technology of the SIMATIC PCS 7 Industrial Workstations.

Overview

The functionality of the engineering system is largely covered by the standard engineering software. The following software options are available in addition for special functions:

- SIMATIC PCS 7 Logic Matrix
- SIMATIC Version Cross Manager
- SIMATIC Version Trail
- SIMATIC PCS 7 Plant Automation Accelerator
- SIMATIC PCS 7 Import/Export Assistant
- SIMATIC PDM Process Device Manager for SIMATIC PCS 7 (see "Plant device management")
- Engineering Process Safety (see Section "Safety Integrated for Process Automation")
- SIMATIC PCS 7 Maintenance Station Engineering (see section "Plant Device Management")
- SIMATIC Route Control Engineering (see section "Route Control")
- SIMATIC PCS 7 TeleControl OS Engineering (see Technology components, "Telecontrol technology" in the ST PCS 7 T catalog)
- SIMATIC PCS 7 PowerControl OS Engineering (see Technology components, "Switchgear automation" in the ST PCS 7 T catalog)
- S7-PLCSIM for the functional testing of CFC/SFC programs

Design

SIMATIC PCS 7 Engineering System

Versions	Classic, exclusively engineering station						Combined engineering/operator station for small applications	
Productive operation as an operator station possible	-						●	
Version	Project server		Project client		Single station		Single station	
	BCE	IE	BCE	IE	BCE	IE	BCE	IE

SIMATIC PCS 7 Industrial Workstation incl. operating system

Industrial Workstation for ES/OS single station	BCE communication ¹⁾	-	-	●	-	●	-	●	-
	IE communication	-	-	-	●	-	●	-	●
Industrial Workstation for OS server	BCE communication ¹⁾	●	-	-	-	-	-	-	-
	IE communication	-	●	-	-	-	-	-	-

Additional Industrial Ethernet communications software

SIMATIC NET HARDNET-IE S7 REDCONNECT PowerPack for IE communication with redundant automation systems (additive to SIMATIC NET HARDNET-IE S7)	-	●	-	●	-	●	-	●
---	---	---	---	---	---	---	---	---

Standard engineering software, alternatives

SIMATIC PCS 7 Engineering Software, unlimited POs	AS and OS, incl. 2-hour OS test mode	●	●	●	-
	AS	●	●	●	-
SIMATIC PCS 7 ES single station, with 250 AS/OS Runtime POs	-	-	-	●	

Supplementary engineering software (optional)

- SIMATIC PCS 7 Logic Matrix
- Version Cross Manager
- Version Trail
- SIMATIC PCS 7 Plant Access Accelerator
- Import/Export Assistant
- Engineering Process Safety (SIMATIC S7 F Systems, SIMATIC S7 Safety Matrix Tool)
- PCS 7 Maintenance Station Engineering
- SIMATIC Route Control Engineering
- SIMATIC PDM
- SIMATIC PCS 7 TeleControl OS Engineering²⁾
- SIMATIC PCS 7 PowerControl OS Engineering²⁾
- Simulation with S7-PLCSIM

Hardware and software components of the engineering system, as well as possible configurations

¹⁾ Basic Communication Ethernet (BCE) for up to 8 automation systems (no redundant systems)

²⁾ Products can be found in Catalog ST PCS 7 T, SIMATIC PCS 7 technology components

Note on Microsoft SQL Server software

The "SQL Server" software from Microsoft which is delivered together with SIMATIC PCS 7 is exclusively intended for this process control system. It must not be used in any other context without previous written approval by Siemens.

SIMATIC PCS 7 system software

Engineering system
ES software

Standard engineering software

Overview

The standard engineering software provides the basic functionality for configuration of SIMATIC PCS 7 plants with:

- Automation systems
- Process I/O
- Field devices
- Communication networks
- Operator systems
- Maintenance station
- SIMATIC BATCH
- SIMATIC Route Control
- SIMATIC PCS 7 TeleControl
- SIMATIC PCS 7 PowerControl

Licensing of the standard engineering software depends on use of the engineering station as:

- Classic, dedicated engineering station (not suitable for productive operation as an operator station)
- Combined engineering/operator station for small applications (suitable for productive operation as an operator station)

Application

Classic, exclusive engineering station with unlimited number of process objects for engineering (Engineering unlimited POs)

Two software versions with unlimited engineering POs are available for the classical engineering station:

- AS/OS – for engineering of automation systems (AS) and Operator Systems (OS)
- AS – only for AS engineering

With the AS/OS software version, the OS configuration can be tested in an OS test mode limited to 2 hours. This OS test mode is not suitable for productive operation. After 2 hours, the engineering station automatically switches to demonstration mode.

Rental License

A 30-day or 50-hour rental license for AS engineering (unlimited POs) gives you a cost-effective alternative for short-term projects or short-term capacity bottlenecks.

The licenses for 30 days and 50 hours differ as follows with regard to runtime billing:

- With the 30-day license, the uninterruptible timer starts at the time of first usage. Time billing is thus independent of usage.
- With the 50-hour license, only the actual period of use is billed. The timer stops when the SIMATIC PCS 7 application is exited, and restarts when the application is opened again.

Combined engineering/operator station for small applications

The combined engineering/operator station is designed to support compact process control plants. This combines an unlimited AS/OS Engineering license (unlimited POs) with an AS/OS Runtime license for 250 POs. These licenses can only be used together on a station. It is not possible to separate the Engineering and Runtime licenses for use on different stations.

The runtime POs can be expanded with cumulative Runtime licenses:

- SIMATIC PCS 7 AS Runtime license for 100, 1 000 or 10 000 POs, see "Automation systems", "Modular AS 410-5H and AS 410E systems", [see page 13/4](#)
- SIMATIC PCS 7 OS Runtime license for 100, 1 000 or 5 000 POs, see "Operator System", "OS software" under "OS standard software for single station/server/client", [see page 5/6](#)

Division of work during engineering

To enable engineering to be carried out in the shortest possible time, it is necessary to use resources optimally. The Engineering System of the SIMATIC PCS 7 process control system not only supports uniform engineering of the project on an engineering station but also provides various options for dividing the work.

Concurrent Engineering

With Concurrent Engineering multiple project engineers can work concurrently on one project in CFC and SFC, without having to split the project up into sub-projects beforehand. During commissioning, for example, charts can be used in the online (debug) mode and at the same time changes can be made to the project. The Graphics Designer supports parallel working on a project even when creating process pictures.

The project is localized on one of the participating engineering stations, the "project server". The engineering stations working as "project clients" can access the project data via LAN/WAN. A specific chart can be found very quickly using a cross-project search function.

CFC and SFC charts can be opened and viewed by several project engineers concurrently. However, the system rejects concurrent write accesses to the database. If the project engineer attempts to access a chart which is already being used, a corresponding warning is output in a dialog window.

Every engineering station in the network (project server/client) is able to download configuration data to a SIMATIC PCS 7 subsystem provided it has the required communication connections.

Multiproject Engineering

Multiproject engineering allows a complex project to be divided into multiple subprojects in accordance with technological criteria so that several different teams can work on the project in parallel. To achieve this, a host "Multiproject" is defined in the SIMATIC Manager. The individual projects can be added or removed from a multiproject at any time. Similarly, projects can be divided or combined (Branch & Merge).

The subprojects in a multiproject are stored on a central server and moved to the local engineering stations for editing. The engineering performance is then not affected by network access.

Central configuration functions for multiprojects help to reduce the configuration overhead. For example, a hierarchy folder can be created in the current project and also automatically in all other projects. It cannot be modified there, but objects can be inserted. All block types used in a multiproject can also be updated centrally.

Function

Essential tools of the standard engineering software and their functions:

SIMATIC Logon

SIMATIC Logon is a user administration and access control function integrated in the engineering system. Together with the detailed recording facilities provided by the change log, SIMATIC Logon offers plant owners exceptional system support when verifying changes.

Using SIMATIC Logon, the administrator can assign specific access privileges to groups of users, thus controlling the possibilities for data access. Access rights for stations of the process control system and operator privileges for blocks can both be set up. Configurable change logs permit the recording of all access operations to the engineering system as well as all online changes concerning the automation systems, Operator Systems, SIMATIC BATCH or SIMATIC Route Control.

If the modification reports are linked to the data of SIMATIC Logon during evaluation, it can be clearly proven who has carried out a specific modification and at what time. Such verifications are often the object of special sector-specific requirements, formulated, for example, in FDA 21 CFR Part 11 or GAMP.

SIMATIC Manager

The SIMATIC Manager is the control center of the engineering system. It is the integration platform for the engineering toolset as well as the configuration basis for all engineering tasks of the SIMATIC PCS 7 process control system. All aspects of the SIMATIC PCS 7 project are created, managed, archived and documented here.

The engineering toolset contains tools which are optimally matched to one another for system-wide project-oriented engineering, and which simultaneously provide the basis for asset management of the I&C equipment. These include tools for effective engineering of the following components:

- Control system hardware including distributed I/O and field devices
- Communication networks
- Automation functionality for continuous and batch processes (AS engineering)
- Operation and monitoring functionality (OS engineering)
- Mass data engineering and cooperation with CAD/CAE planning tools
- Diagnostics and asset management functionality
- Batch processes, automated with SIMATIC BATCH
- Material transport, controlled by SIMATIC Route Control
- Safety applications (Safety Integrated for Process Automation)

Technologists as well as process and production engineers can carry out planning and configuration in their familiar environments when using this range of tools as well as predefined blocks and charts.

The hardware required for use in a SIMATIC project, such as automation systems, communications components and process I/O, is stored in an electronic catalog. The hardware can be configured and parameterized using the HW Config tool.

Creating hierarchy folders implements a project structure, the plant hierarchy (PH). By storing CFCs and SFCs for automation systems and pictures and reports for operator stations in a hierarchy folder along with additional documentation, the configuring engineer implicitly determines the hierarchical assignment.

Function blocks (FBs) and functions (FCs) can be encrypted and decrypted with the S7-Block Privacy application to protect know-how. Following encryption, the blocks and their attributes can no longer be modified. Only the interfaces of the blocks are then visible.

To implement the automation logic, standardized function blocks must be combined with other blocks in the graphic configuration tool CFC according to technological specifications. You can simply select predefined blocks or charts for this purpose from a catalog and then position, graphically interconnect and configure them in the working area. The process tag data relevant to operation and monitoring, such as messages and variables, are generated at the same time.

The SIMATIC PCS 7 Logic Matrix can be used for fast and easy creation of the interlock logic between various Control Modules/Equipment Modules.

Sequential controls permit control and selective processing of the basic automation functions created per CFC by means of changes in operating mode and status. Convenient editing functions for the graphic configuration of sequential controls as well as powerful test and commissioning functions are offered by the SFC editor.

Complete SIMATIC PCS 7 projects or all project modifications can be compiled in one working step and downloaded to the target systems involved, e.g. to automation systems, Operator Systems or SIMATIC BATCH. The engineering system automatically ensures that the sequence is correct. The procedure is displayed and controlled in a central dialog.

A more effective method for less comprehensive changes to the standard automation, e.g. addition or modification of single process tags, is selective compilation and downloading at chart level. This can be started from the technological hierarchy, from the CFC, or from the chart folder.

The project engineer can recognize all changes since the last download by their color, and the current chart states by means of the corresponding symbols. The project engineer can make a specific choice in a dialog form for selective downloading. In association with the Version Trail, each download is automatically followed by archiving.

In the case of blocks being executed on the AS 410 automation system, it is even possible to change types during runtime by means of seamless copying (TCiR).

SIMATIC PCS 7 system software

Engineering system

ES software

Standard engineering software

Function (continued)

The SIMATIC Manager can also be used to organize the project data for engineering of the Operator Systems. All the process tag data relevant to operation and monitoring is generated when the automation function is defined. A powerful Graphics Designer is available for generation of the process pictures. The basis for generating process pictures is provided by static symbols and dynamic block icons and faceplates that are organized in libraries and linked to the parameters of the function blocks.

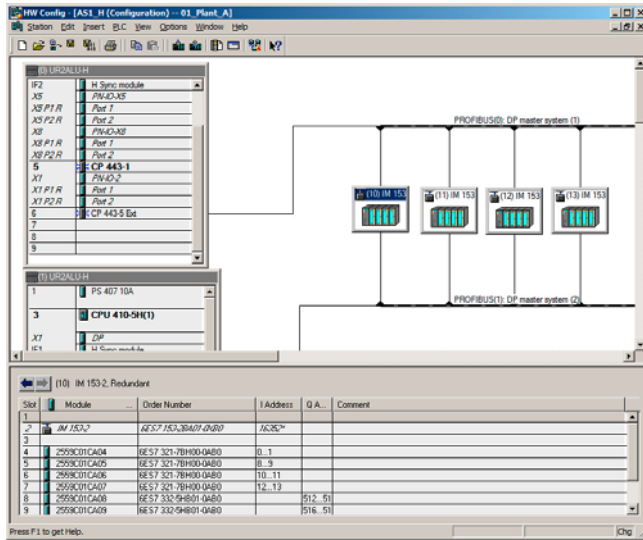

Component view: hardware configuration in the SIMATIC Manager with HW-Config

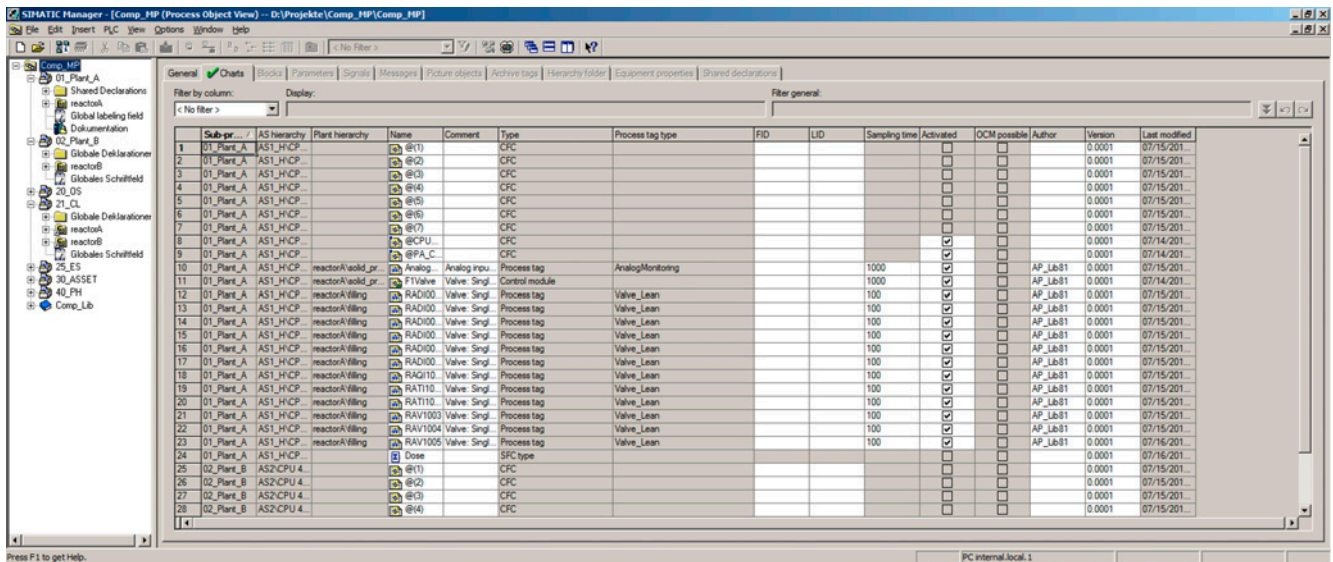

Process tags in the process object view

Project views

The various tasks for creating a plant project are supported by the following project views:

- **Component view (HW Config)**
for configuration of hardware such as automation systems, bus components or process I/O
- **Process object view**
as the central development environment for all aspects of process tags/objects

The process object view supports the work carried out by a process engineer by providing a universal view of the process tag. It shows the plant hierarchy represented in tree form in combination with a tabular view of all aspects of the process tag/object (general, charts, blocks, parameters, signals, messages, picture objects, archive variables, hierarchy folders, equipment properties and global declarations). This provides the technologist with fast orientation.

All objects in the marked branch of the hierarchy are displayed in the table so that they can be directly processed with user-friendly edit, filter, replace, import and export functions. A special test mode offers the facility for testing process tags and CFCs online and for starting them up.

The OS areas and the image hierarchy for process control, as well as the SIMATIC PCS 7 asset management, can be derived from the technological hierarchy. Furthermore, it also forms the basis for the plant-oriented identification of process objects.

Common displays can be positioned in pictures by means of the image hierarchy, and automatically linked to lower-level images. The configuration engineer is only responsible for the correct positioning. Since the number of common display fields and their semantics can be configured, it is also possible to implement customized alarm configurations.

Function (continued)

I&C and process messages are already pre-configured in the function blocks, and operator input messages are already pre-configured in the faceplates. These are automatically generated when the triggering event occurs. If required, message texts can be modified or message priorities defined.

Using the process object view, "Smart Alarm Hiding" can also be configured. This refers to the dynamic hiding of alarms that are of secondary importance to the safe and interference-free operation of the plant under certain plant conditions. Depending on the operating status of a plant unit (startup, service etc.), messages of the technological blocks grouped in this plant unit are shown or hidden in accordance with the previously set configuration. Alarms can be displayed or hidden separately for each of the maximum 32 operating states through selection of option boxes in the alarm matrix of the process object view. Although hidden alarms are not signaled visually and audibly, they are still logged and archived as before.

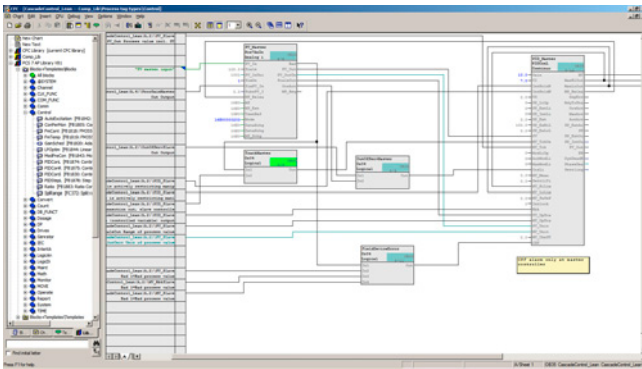

Continuous function chart

Continuous function chart (CFC)

The CFC editor permits graphic configuration of the continuous automation functions. In addition to convenient editing functions, its scope of functions also includes powerful test and commissioning functions as well as individually configurable documentation functions.

When creating a new CFC, a new runtime group with the same name as the chart is created. All the blocks that are subsequently entered in the chart are automatically added to this runtime group. Each block is therefore already assigned runtime properties when it is inserted, and configuration engineers can optimize these properties by means of modifications in the runtime editor or by using algorithms.

The algorithm first determines the optimum block sequence separately for each runtime group, and then the optimum sequence of runtime groups.

Instances of function block types can be positioned on CFCs, assigned parameters, and interconnected. Operator privilege levels can already be defined at block level for each block attribute so that finely granular operator privileges can be implemented.

Additional potential for rationalization is offered by special configuration techniques such as chart-in-chart for implementing hierarchical charts, or the multiple use of chart block types (individual control unit types and process tag types) or SFC types (standardized sequence controls) in the form of instances.

The CFC editor supports the following types of standardized software modules:

- **Function block type**

The function block types supplied with I&C libraries are used for I&C modeling of engineering equipment such as valves or motors. The smallest standardized software modules for multiple usage have connections for actuating and control signals and for parameter assignment and monitoring functions. Some also contain interlocking functions for automatic transition to defined safety settings.

- **Process tag type**

Process tag types implemented with function blocks each represent a standardized CFC for the basic automation of specific I&C functions, e.g. for a level controller. Their instances can be modified centrally by the type-instance concept, and also manually adapted and linked.

- **Control Module type**

The Control Module type (CMT) marks a new type of standardized software module that offers even more efficient engineering than classic process tag types. A CMT can contain blocks, charts, control variables (block I/Os such as signals and parameters) and messages.

Note: As the function "Control Module adjustment" is based on a basic functionality of the Version Cross Manager (VXM), you need a VXM license to use this function, [see page 3/14](#). In the absence of a license, a message appears telling you to install Version Cross Manager. This is not actually necessary, all you need to install is a valid VXM license that will enable the relevant functionality on the engineering station.

Note:

The CFC is not just a component in the standard engineering software of the SIMATIC PCS 7 process control system. As a separate product, it can also be used together with other SIMATIC products in the context of Totally Integrated Automation (TIA). This SIMATIC CFC is a component from catalog ST 70, "SIMATIC Software" (article number of the current SIMATIC CFC V9.0, goods delivery: 6ES7658-1EX58-0YA5; online delivery: 6ES7658-1EX58-0YH5).

SIMATIC PCS 7 system software

Engineering system

ES software

Standard engineering software

Function (continued)

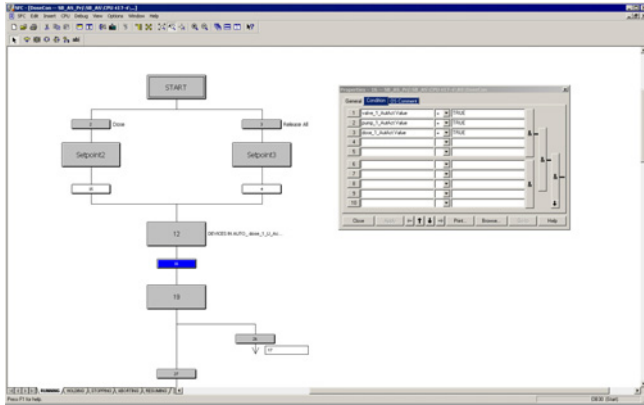

Sequential function chart

Sequential function chart (SFC)

The SFC editor is used for the graphical configuration and commissioning of sequential controls for batch production operations. It possesses convenient editing functions as well as powerful test and commissioning functions. An integrated graphical formula editor for arithmetic operations, Boolean algebra and mathematical functions enables calculations within the SFC.

Using a sequential control, basic automation functions usually created using CFC are controlled and selectively processed by means of changes in operating mode and status. Depending on the subsequent use, the sequential controls can be created either as an SFC plan or SFC type.

SFC plan

The SFC can be used to implement sequence controls which can be applied once and which access several partial areas of the production plant. Each SFC has standardized inputs and outputs for status information and for control by the user program or the user. The SFC plan can be positioned and linked as a block in the CFC. The required CFC block connections are selected by simple operations and connected to the steps or transitions of the step chains. A status management conforming to ISA 88 enables the configuration of up to 8 separate sequencers within a single SFC, e.g. for states such as RUNNING, HOLDING or ABORTING, or for different operating modes.

SFC type

SFC types are standardized sequential controls which can be applied repeatedly and which access one partial area of the production plant. They can be organized in libraries, and handled like normal function blocks, i.e. they can be selected from a catalog and positioned, interconnected and configured as an instance in a CFC plan.

Changes to the original automatically result in corresponding changes in all instances. An SFC type may contain up to 32 sequences. Using the function "Create/update block symbols", a block symbol is automatically positioned and interconnected in the associated process picture for all SFC instances with HMI features.

I&C libraries

The use of library elements plays a major role in minimizing the amount of engineering required and thus also the project costs.

Two process control libraries are integrated in the standard engineering software of SIMATIC PCS 7:

- Advanced Process Library (current standard, pre-installed)
- PCS 7 Standard Library (former standard, can be installed subsequently if required)

Pre-configured and tested blocks, faceplates and symbols are organized in these libraries and form the basic elements for the graphic configuration of automation solutions.

The comprehensive range of blocks can be categorized as follows:

- Blocks for mathematical operations, analog and digital logic
- Interlocking blocks
- Technological function blocks with integral display, operation and signaling functions, e.g.:
 - Standard Control and Advanced Process Control blocks
 - Motor and valve blocks
 - Counter blocks
 - Dosing block
- Blocks for the integration of field devices
- Operator control and monitoring blocks
- Message and diagnostics blocks

Furthermore, pre-configured process tag types for process equipment such as pumps, valves, dosing units and controllers (cascade, split-range) etc. extend the scope of library elements.

This is advantageous for adaptation of the user software following a system upgrade so that multiple versions of a library can exist side by side.

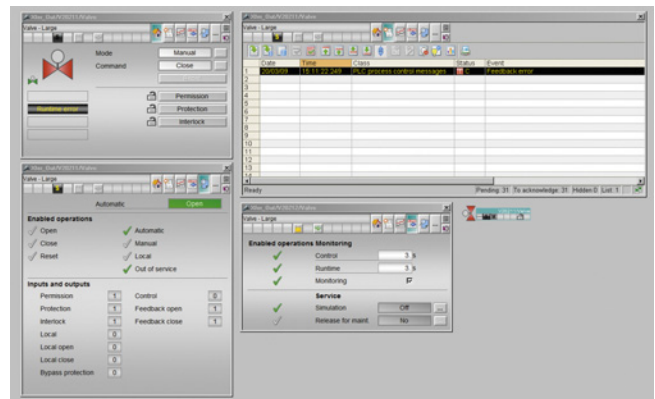

Examples of OS standard faceplates from the SIMATIC PCS 7 Advanced Process Library, valves

Advanced Process Library

The Advanced Process Library (APL) based on many years of experience of project engineers and plant owners takes into consideration current NAMUR recommendations and PNO specifications. Proven functions as well as visually attractive GUIs for a high level of operator convenience facilitate and also force interaction of operators with the plant.

Function (continued)

Alternative, small versions of function blocks reduced to core functions, whose block icons and faceplates occupy less space in the process picture, improve clarity in complex process pictures.

Other features worth mentioning are:

- Special operating modes:
 - "Local" for integration and application of local control options
 - "Out of service" for deactivating a process tag for maintenance and service
 - Several faceplate views:
 - "Preview" with information on the I/O signal status, automatic control, and possible/permissible operator inputs; display of real value for simulation
 - "Memo view" for temporary operator information
 - Convenient interlocking blocks with initial signal information, can be directly called from the technological function blocks, e.g. from a motor block
 - Flexible adaptation of functions in the library blocks
 - Commissioning support through direct simulation on the operator station
 - Protection against operator errors as the result of detailed grading of user privileges
 - Explicit enabling/disabling of operations for a process tag for individual operator stations of the plant using the function "Local operator enabling"
 - Integration of any compact drives and switch/starter objects via standard PROFIBUS profiles
 - Coordination of multiple access operations, e.g. of SFC/SIMATIC BATCH, to equipment such as valves, dosing units or pumps
 - Tacking of operator input windows facilitates repeated, successive operations
 - Browser for the process tag selection by status
 - Customized online trends for display
 - Reduced operator workload and faster operator control with process tag groups assembled online for standard situations
- Note:
SIMATIC PCS 7 Advanced Process Graphics from catalog ST PCS 7 T (SIMATIC PCS 7 technology components) is required.

Technology libraries

The additional technology libraries "Industry Library" and "Condition Monitoring Library" offered in Catalog ST PCS 7 T (SIMATIC PCS 7 technology components) expand the standard functionality of the APL. All display icons, function blocks and faceplates of these libraries are in APL design.

The Industry Library contains blocks for:

- Building automation (heating, ventilation, air conditioning)
- Operator control and monitoring using SIMATIC HMI Comfort Panels
- Integration of SIMATIC S7 Package Units and RTUs based on S7-300
- Connection of external Advanced Process Control systems
- Hierarchical multi-control room operation
- Other technological functions, e.g. for expanding measured value monitoring, or specifying a setpoint trend

The Condition Monitoring Library contains blocks for:

- Monitoring of centrifugal pumps (PumpMon)
- Monitoring of control valves (VlvMon)
- Online valve test during operation (PST)
- Monitoring for pressure loss, and early detection of blockages (PressDropMon)
- Detection of steady states of a dynamic process or steady state of a signal

Advanced Process Control (APC) functions

In addition to numerous basic control functions, e.g. PID control, cascade control, split range control and ratio control, the I&C libraries of SIMATIC PCS 7 also provide function blocks and templates for advanced control functions at no extra cost.

Gain scheduling

The GainSched block allows continuous adjustment of the controller parameters in non-linear processes depending on the operating point. The block, which works in a similar manner to the polygon block, can derive three separate output values from one input value (measured variable X), which serve as regulating parameters for an interconnected controller block. Depending on the characteristic of the measured variable X, the GainSched changes the regulating parameters of the combined closed-loop controller in a sliding manner.

Override control

The outputs of two or more controllers are connected to a common final controlling element. The decision concerning which controller actually receives access to the final controlling element is made depending on the evaluation of the current process state.

Lead-lag/feed-forward control

A strong interference which can be measured is compensated in advance by feed-forward control. The control is thus limited to model uncertainties and non-measurable faults.

SIMATIC PCS 7 system software

Engineering system

ES software

Standard engineering software

Function (continued)

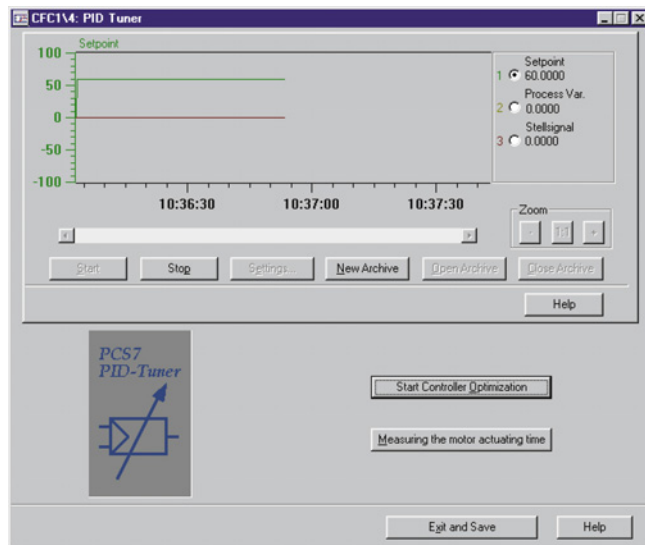

PID tuning

The integrated PID Tuner is suitable for optimization of the CTRL_PID and CTRL_S software controllers in circuits with PID, PI, or P control. On the basis of an experimentally determined model of the controlled system, favorable controller parameters for an optimum disturbance response or an optimum control response of the controller can be determined according to the procedure of absolute value optimization. Optimization can be carried out in manual or automatic mode. The typical controller values (actual value, setpoint, manipulated variable) are recorded by a trend function. The transient response of the controllers with the determined parameters can be checked by defining jumps. The controller parameters can be saved, and recalled as required.

Monitoring of the control quality

The ConPerMon block determines the control quality of a controller block (e.g. PID controller) on the basis of the online data of the setpoint, actual value and manipulated variable. Depending on deviation of the comparison quality, e.g. the control quality at commissioning, it can trigger a warning or an alarm. The faceplates of all control quality monitoring of a plant or a plant unit can be summarized in OS screens, which enables problems to be detected early on, analyzed, and specifically corrected.

Smith Predictor

The Smith Predictor can significantly improve the control quality of processes with long and relatively constant dead times. By eliminating the dead time component using a process model running parallel to the actual process, the controller can be designed for a process free of dead time, and thus set more effectively.

Model-based predictive multi-variable control

Model-based predictive multi-variable controllers (MPC) separately analyze the behavior of several interdependent variables for complex processes over a longer period. The results are used for optimized control of these variables. They eliminate adverse interactions which occur with separate control of the interdependent variables. Using a mathematical model of the process dynamics, MPCs are able to predict the future process response over a defined period of time (prediction horizon) and optimize a quality criterion on this basis.

The APL provides two multi-variable controllers with different functionalities and performance:

- MPC4x4 (ModPreCon) for up to 4 coupled manipulated variables and controlled variables
- MPC10x10 for up to 10 coupled manipulated variables and controlled variables and up to 4 measurable disturbance variables

Note:

Model-based multi-variable controllers make high demands on memory and processing time of the designated automation system. For that reason, please check the resources of the designated automation system before using them.

Graphics Designer

The project data for the engineering of the Operator Systems are organized with the SIMATIC Manager. All the data relevant to operation and monitoring of a process tag, such as messages and HMI variables, are generated automatically during definition of the automation function. A powerful graphics designer is available for the generation of process pictures.

Ordering data	Article No.	Article No.
<p>Standard engineering software</p> <p>Runs with the following operating systems (see SIMATIC PCS 7 Readme for the latest information¹⁾):</p> <ul style="list-style-type: none"> Windows 10 Enterprise 2019 LTSB Windows Server 2019 Standard Edition 		<p>SIMATIC PCS 7 AS Engineering Software V9.1 Unlimited POs</p> <p>6 languages (English, German, French, Italian, Spanish, Chinese), software class A</p> <p>Without SIMATIC PCS 7 Software Media Package</p> <ul style="list-style-type: none"> Goods delivery License key on USB flash drive, Certificate of License <ul style="list-style-type: none"> - Floating license for 1 user - Rental license for 30 days (time billing independent of use) - Rental License for 50 hours (time billing dependent on use) Online delivery License key download, online Certificate of License <u>Note:</u> Email address required! <ul style="list-style-type: none"> - Floating license for 1 user - Rental license for 30 days (time billing independent of use)
<p>Software for a classic, dedicated engineering station without quantity limitation (not suitable for productive operation as an operator station)</p>		<p>6ES7658-1AX68-0YB5 6ES7658-1AX68-0YA6 6ES7658-1AX68-0YB6 6ES7658-1AX68-0YH5 6ES7658-1AX68-0YH6</p>
<p>SIMATIC PCS 7 AS/OS Engineering Software V9.1 Unlimited POs, <u>activated for 2-hour OS test mode</u></p> <p>5 languages (English, German, French, Italian, Spanish), software class A, floating license for 1 user</p> <p>With SIMATIC PCS 7 Software Media Package</p> <ul style="list-style-type: none"> Goods delivery License key on USB flash drive, Certificate of License, bundled with 1 × SIMATIC PCS 7 Software Media Package per order item Online delivery License key download and online Certificate of License, combined with SIMATIC PCS 7 Software Media Package (software download and online Certificate of License) <u>Note:</u> Email address required! 	<p>6ES7658-5AX68-0YA5 6ES7658-5AX68-0YH5</p>	<p>Software for a combined engineering/operator station for small applications (suitable for productive operation as an operator station)</p> <p>SIMATIC PCS 7 ES single station V9.1 Including 250 AS/OS Runtime POs</p> <p>5 languages (English, German, French, Italian, Spanish), software class A, single license for 1 installation</p> <p>With SIMATIC PCS 7 Software Media Package</p> <ul style="list-style-type: none"> Goods delivery License key on USB flash drive, Certificate of License, bundled with 1 × SIMATIC PCS 7 Software Media Package per order item Online delivery License key download and online Certificate of License, combined with SIMATIC PCS 7 Software Media Package (software download and online Certificate of License) <u>Note:</u> Email address required!
<p>SIMATIC PCS 7 AS/OS Engineering Software ASIA V9.1</p> <p>2 languages (English, Chinese), software class A, floating license for 1 user</p> <p>With SIMATIC PCS 7 Software Media Package ASIA</p> <ul style="list-style-type: none"> Goods delivery ASIA license key on USB hardlock and Certificate of License, bundled with 1 × SIMATIC PCS 7 Software Media Package ASIA per order item 	<p>6ES7658-5AX68-0CA5</p>	<p>6ES7651-5AA68-0YA0 6ES7651-5AA68-0YH0</p>
		<p>SIMATIC PCS 7 ES single station ASIA V9.1 Incl. 250 AS/OS Runtime POs</p> <p>2 languages (English, Chinese), software class A, single license for 1 installation</p> <p>With SIMATIC PCS 7 Software Media Package ASIA</p> <p>Goods delivery ASIA license key on USB hardlock, Certificate of License, bundled with 1 × SIMATIC PCS 7 Software Media Package ASIA per order item</p> <ul style="list-style-type: none"> ASIA SN ASIA (including SOFTNET REDCONNECT) <p>6ES7651-5AA68-0CA0 6ES7651-5AA68-6CA0</p>

¹⁾ See "Software Media and Logistics" section, under "System documentation", see page 1/7

You can find more information on the Software Media Package in the section "Software Media and Logistics", subsection "PCS 7 Software Packages", see page 1/2

SIMATIC PCS 7 system software

Engineering system

ES software

Standard engineering software

More information

Regional product versions

All SIMATIC PCS 7 software products are designed for international use, in other words there is only one product version for worldwide use and this is offered in up to 6 languages: English, German, French, Italian, Spanish and Chinese. However, the number of supported languages is not standard; it can vary from product to product.

In addition, a regional "ASIA" product version will also be offered for the SIMATIC PCS 7 Software Media Package and specific SIMATIC PCS 7 software products of the "Engineering System" and "Operator System" system components. The ASIA products are available in two languages: English and Chinese (simplified). They are explicitly identified in the name by the suffix "ASIA".

If a product listed in this catalog does not have the suffix "ASIA" in its name, it can always be used globally. However, the following restriction applies: If a regional ASIA product is offered, the pendant for international use does not support the Asian languages (currently Chinese simplified) present in the ASIA product.

The products for international use, i.e. products without the suffix "ASIA", are not intended as the basis for runtime systems with fonts in Asian languages.

The following special points must be observed as a result of the definition of separate products for installation software and licenses. The SIMATIC PCS 7 installation software is available in the form of two data medium packages:

- SIMATIC PCS 7 Software Media Package
- SIMATIC PCS 7 Software Media Package ASIA

The specific ASIA software licenses harmonize exclusively with the SIMATIC PCS 7 Software Media Package ASIA. SIMATIC PCS 7 software licenses for which there is no ASIA pendant can be used with both SIMATIC PCS 7 Software Media Packages.

Overview

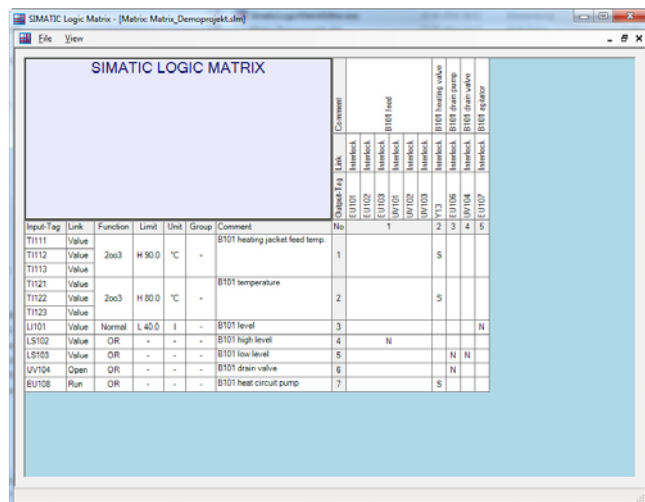

The screenshot shows the SIMATIC Logic Matrix Editor interface. At the top, there is a title bar and menu options. Below that is a large empty area for the logic matrix. At the bottom, there is a table with the following data:

Input Tag	Link	Function	Limit	Unit	Group	Comment	No.	U100	U101	U102	U103	U104	U105	U106	U107	U108
TI111	Value					B101 heating jacket feed temp.	1									
TI112	Value	2003	H 90.0	°C	-											
TI113	Value															
TI121	Value					B101 temperature	2									
TI122	Value	2003	H 90.0	°C	-											
TI123	Value															
LI101	Value	Normal	L 40.0	l	-	B101 level	3									N
LS102	Value	OR	-	-	-	B101 high level	4		N							
LS103	Value	OR	-	-	-	B101 low level	5						N	N		
UV104	Open	OR	-	-	-	B101 drain valve	6									
EU108	Run	OR	-	-	-	B101 heat circuit pump	7								S	

Logic Matrix Editor within the SIMATIC PCS 7 Engineering System

The SIMATIC PCS 7 Logic Matrix is based on the principle of logic creation with a cause and effect matrix—similar to the long-established SIMATIC S7 Safety Matrix for safety-related applications. It enables easy creation of the interlock logic between technological functions (e.g. control modules or equipment modules) of the automation project. There is no time-consuming configuring of the interlock logic in the CFC.

The SIMATIC PCS 7 Logic Matrix Tool, which can be opened from SIMATIC Manager, is used to create and edit the Logic Matrix oriented to one controller in each case and then to integrate the created matrix data at the chart level in the CFC project. The APL-based process tag types of the Control Module are linked with the cause or effect blocks of the Logic Matrix by templates created with the Link Type Editor of the Logic Matrix (Link Types).

The matrix table is comparable to a spreadsheet program. The configuration engineer first enters the possible events (inputs) in the horizontal lines, and then configures their type and number, logic operations, timings, alarms and possible bypass functions. He then defines possible actions (outputs) to these events in the vertical columns. The events and reactions are linked by simply clicking the cell at the intersection of the row and column.

The SIMATIC PCS 7 Safety Matrix Viewer enables operator control and monitoring of the Logic Matrix on the operator station (OS Single Station and OS Client). The Logic Matrix faceplate can also be opened via the faceplates of the technology objects which have been linked together via the cause and effect matrix.

Based on this causal chain, jumps from the Effect faceplate to the Cause faceplate and vice versa are possible via the Logic Matrix faceplate.

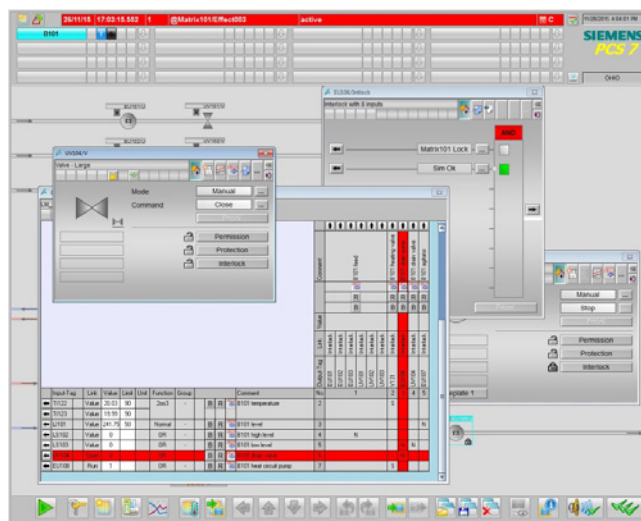

Faceplates of the Logic Matrix and the linked Control Module in the Logic Matrix Viewer of the SIMATIC PCS 7 Operator Station

Ordering data

Article No.

SIMATIC PCS 7 Logic Matrix

SIMATIC PCS 7 Logic Matrix Viewer V9.1

Operator control and monitoring of the SIMATIC PCS 7 Logic Matrix via OS single station/OS client

Runtime software, 2 languages (English, German), software class A

Runs with the following operating systems (see SIMATIC PCS 7 Readme for the latest information¹):

- Windows 10 Enterprise 2019 LTSC 64-bit
- Windows Server 2019 Standard Edition 64-bit

Single license for 1 installation, without SIMATIC PCS 7 Software Media Package

Goods delivery

License key on USB flash drive and Certificate of License

6ES7658-1JB68-2YA0

¹) See "Software Media and Logistics" section, under "System documentation", see page 1/7

SIMATIC PCS 7 system software

Engineering system

ES software

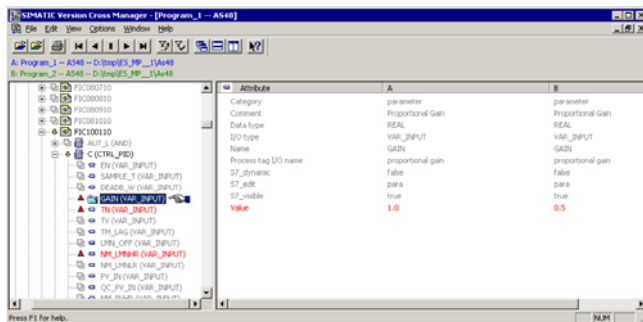
SIMATIC Version Cross Manager**Overview**

The SIMATIC Version Cross Manager is a user-friendly tool for determining the differences between various versions of individual projects or multi-projects by:

- Tracing missing, additional or differing objects by comparing hardware configuration, communication, plant hierarchy, CFC/SFC plans, SFC details, block types, messages, global tags, signals and run sequences
- Graphic display of comparison results in a combination of tree and tabular formats
- Clear hierarchical structuring according to the technological hierarchy of the plant
- Color-coded identification of the differences

Note:

As the function "Control module adjustment" is based on a basic functionality of the Version Cross Manager (VXM), you need a VXM license to use this function. In the absence of a license, a message appears telling you to install Version Cross Manager. This is not actually necessary, all you need to install is a valid VXM license that will enable the relevant functionality on the engineering station.

Ordering data**Article No.****SIMATIC Version Cross Manager V9.0**

6 languages (English, German, French, Italian, Spanish, Chinese), software class A

Runs with the following operating systems (see VXM Readme in the Siemens Industry Online Support for the latest information)

- Windows 7 Ultimate 64 Bit
- Windows 10 Enterprise 2015 LTS 64 Bit
- Windows Server 2012 R2 Standard Edition 64 Bit
- Windows Server 2016 Standard Edition 64 Bit

Floating license for 1 user, without SIMATIC PCS 7 Software Media Package

- Goods delivery
License key on USB flash drive and Certificate of License and TIA Engineering Toolset CD
- Online delivery
License key download, online Certificate of License and TIA Engineering Toolset (software download)
Note: Email address required!

6ES7658-1CX58-2YA5**6ES7658-1CX58-2YH5****Upgrade package (only for TIA applications)****SIMATIC Version Cross Manager Upgrade from V7.1/V8.2 to V9.0**

6 languages (English, German, French, Italian, Spanish, Chinese), software class A, for operating systems see above

Floating license for 1 user, without SIMATIC PCS 7 Software Media Package

- Goods delivery
License key on USB flash drive, Certificate of License and TIA Engineering Toolset CD
- Online delivery
License key download, online Certificate of License and TIA Engineering Toolset (software download)
Note: Email address required!

6ES7658-1CX58-2YE5**6ES7658-1CX58-2YK5****More information****Upgrade**

You can upgrade SIMATIC PCS 7 engineering systems with engineering software V8.x to version 9.0 with SIMATIC PCS 7 Engineering Upgrade Packages AS/OS. The further developed SIMATIC Version Cross Manager V9.0 is available for use in SIMATIC PCS 7 V9.0. The upgrade to SIMATIC Version Cross Manager V9.0 is a component of the Engineering Upgrade Package AS/OS V8.x to V9.0.

TIA applications

The Version Cross Manager is not only a software component of the SIMATIC PCS 7 Engineering System. As a separate product, it can also be used together with other SIMATIC products in the context of Totally Integrated Automation (TIA).

Overview

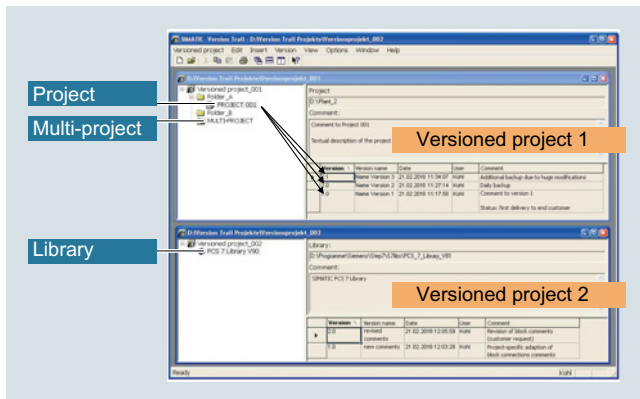

SIMATIC Version Trail is a software option for engineering which, together with the SIMATIC Logon central user administration, can assign a version history to libraries, projects and multi-projects.

Function

SIMATIC Version Trail tags the with a version ID when archiving, and enters the following information in the version history:

- Version
- Version name
- Date and time
- User
- Comment

Individual versions can be retrieved from the archive, and used further. SIMATIC Logon organizes the access protection.

Archiving and retrieval procedures can be automated on a time-driven basis. Retrieval of block parameters from the automation system can be coupled with the archiving procedure, but it can also be performed independently of this on a time-driven basis and with version assignment.

The version history managed by Version Trail can be displayed and printed. An already completed version cannot be modified at a later date. In conjunction with the Version Cross Manager, an archived version can be compared with an existing project or a second archived version.

Ordering data

Article No.

SIMATIC Version Trail V9.0

6 languages (English, German, French, Italian, Spanish, Chinese), software class A

Runs with the following operating systems (see VT Readme in the Siemens Industry Online Support for the latest information)

- Windows 7 Ultimate 64 Bit
- Windows 10 Enterprise 2015 LTS 64 Bit
- Windows Server 2012 R2 Standard Edition 64 Bit
- Windows Server 2016 Standard Edition 64 Bit

Floating license for 1 user, without SIMATIC PCS 7 Software Media Package

- Goods delivery
License key on USB flash drive, Certificate of License and TIA Engineering Toolset CD
- Online delivery
License key download, online Certificate of License and TIA Engineering Toolset (software download)
Note: Email address required!

6ES7658-1FX58-2YA5

6ES7658-1FX58-2YH5

Upgrade package (only for TIA applications)

SIMATIC Version Trail Upgrade from V8.x to V9.0

6 languages (English, German, French, Italian, Spanish, Chinese), software class A, for operating systems see above

Floating license for 1 user, without SIMATIC PCS 7 Software Media Package

- Goods delivery
License key on USB flash drive, Certificate of License
- Online delivery
License key download, online Certificate of License and TIA Engineering Toolset (software download)
Note: Email address required!

6ES7658-1FX58-2YE5

6ES7658-1FX58-2YK5

More information

Upgrade

You can upgrade SIMATIC PCS 7 engineering systems with engineering software V8.x to version 9.0 with SIMATIC PCS 7 Engineering Upgrade Packages AS/OS. These upgrade packages include the upgrade for SIMATIC Version Trail from V8.x to V9.0.

TIA applications

SIMATIC Version Trail is not only a software component of the SIMATIC PCS 7 Engineering System. It is also a separate product which can be used in the context of Totally Integrated Automation (TIA) together with other SIMATIC products.

Note:

Note that Version Trail cannot be used as a stand-alone application; it only runs together with SIMATIC Logon (see "Industrial Security" section, "SIMATIC Logon" subsection, see page 11/8).

SIMATIC PCS 7 system software

Engineering system
ES software

Import/Export Assistant

Overview

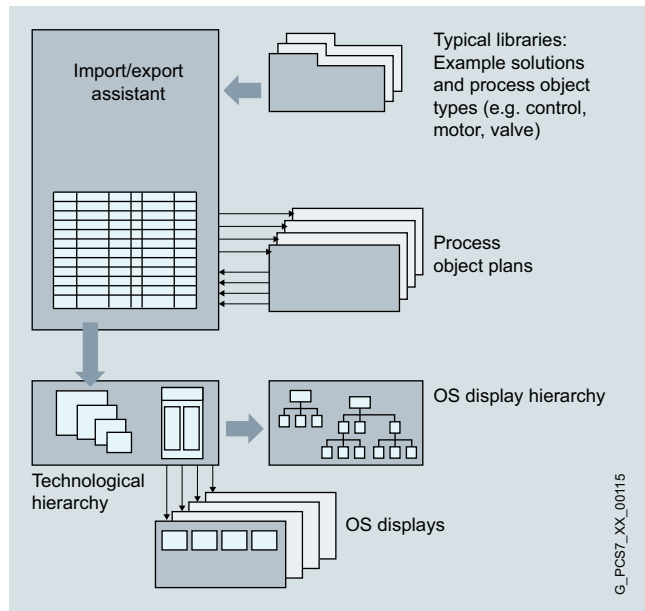

Efficient processing of mass data

The Import/Export Assistant (IEA) can be used for the rational engineering of mass data. The IEA is based on the principle of multiple application of process tag types and example solutions. It is particularly suitable for plants with numerous process tags of the same type or with multiple plant components of the same type.

Following exporting of the PCS 7 project, the data can be modified, duplicated, adapted and also reimported using the IEA editor or a spreadsheet program such as Microsoft Excel.

Comparison with the parameters optimized during commissioning is possible at a later point in time.

Function

- Generation/modification of CM and EM/EPH instances via Plant Generator
- Generation/modification of process tag types or example solutions
- Data import
- Data export
- Matching of process tags

Ordering data

Article No.

**SIMATIC PCS 7
Import/Export Assistant V9.1**
6 languages (English, German, French, Italian, Spanish, Chinese), software class A

Runs with the following operating systems (see SIMATIC PCS 7 Readme for the latest information¹⁾):

- Windows 10 Enterprise 2019 LTSC
- Windows Server 2019 Standard Edition

Floating license for 1 user, without SIMATIC PCS 7 Software Media Package

- Goods delivery
License key on USB flash drive, Certificate of License
- Online delivery
License key download, online Certificate of License
Note: Email address required!

6ES7658-1DX68-2YB5

6ES7658-1DX68-2YH5

¹⁾ See "Software Media and Logistics" section, under "System documentation", see page 1/7

More information

Upgrade

You can upgrade SIMATIC PCS 7 engineering systems with engineering software V8.x and V9.0 to version 9.1 with SIMATIC PCS 7 Engineering Upgrade Packages AS/OS. The upgrade for upgrading the SIMATIC PCS 7 Import/Export Assistant from V8.x and V9.0 to V9.1 is also part of these upgrade packages.

Overview

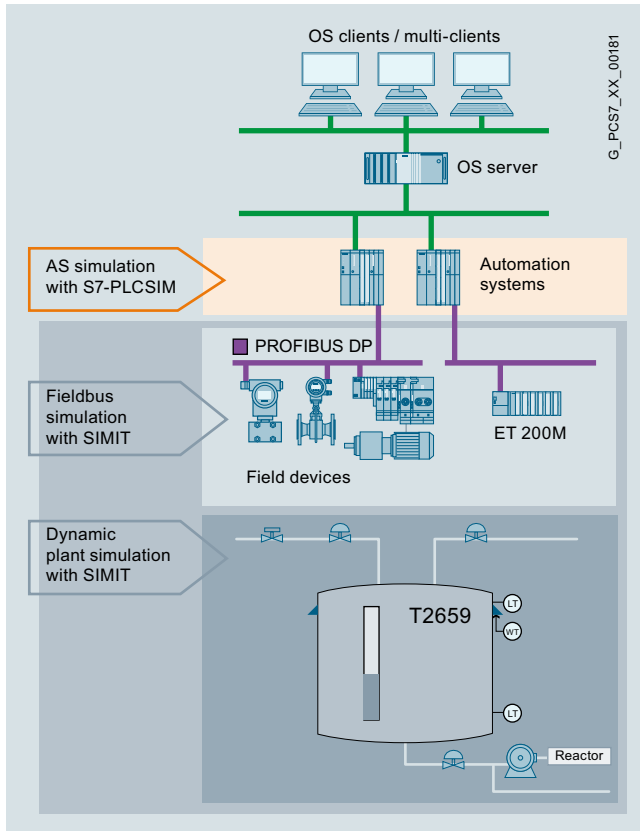

Overview of simulation software for SIMATIC PCS 7

The S7-PLCSIM simulation software supports functional testing of the user programs generated with CFC/SFC on a programming device/PC, irrespective of the availability of the target hardware. Detection and elimination of programming errors is thereby shifted to an earlier development phase. This enables faster commissioning, reduces the costs and increases the program quality.

Note:

S7-PLCSIM as of V5.4+SP8 is compatible with SIMATIC PCS 7 V9.0.

Function

S7-PLCSIM simulates a SIMATIC S7 CPU with the associated process images. The program to be tested is loaded into the simulated S7 CPU in a manner identical to the procedure with real hardware, and is executed there. S7-PLCSIM is completely integrated in STEP 7. Process data can be exchanged between S7-PLCSIM and other Windows applications via an interface.

Ordering data

S7-PLCSIM V5.4 (including SP)

Functional testing on PC/PG of programs created with CFC/SFC
5 languages (English, German, French, Italian, Spanish)

Runs with the following operating systems:

- Windows 7 Ultimate 64-bit
- Windows 10 Enterprise 2015 LTSC 64-bit
- Windows Server 2012 R2 Standard 64-bit

Floating license for 1 user, without SIMATIC PCS 7 Software Media Package

Physical delivery
Software and electronic documentation on CD, license key on USB flash drive, certificate of license

Article No.

6ES7841-0CC05-0YA5

More information

Update/Upgrade

S7-PLCSIM Versions 3.x, 4.x, 5.0, 5.2 or 5.3 can be upgraded to Version 5.4. In addition, a Software Update Service in the form of a subscription is offered for S7-PLCSIM.

You can find more information in the section "Update/Upgrade Packages" under "Updates/Upgrades Asynchronous to the PCS 7 Version" - "Upgrades for S7-PLCSIM Simulation Software", see page 16/24.

Further test and simulation programs

SIMIT Simulation Platform for testing and commissioning of project-specific user software on a partially virtual plant, see Catalog ST PCS 7 T "SIMATIC PCS 7 Process Control System – Technology components" subsection in "Simulations and training systems" section.

SIMATIC PCS 7 system software

Engineering system
Simulation

SIMIT Simulation > SIMIT Simulation Platform

Overview

Real plant environment

Operator Station (OS)



Automation System (AS)

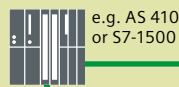

Remote IO/
periphery



Actuators/
sensors



Plant/
machine



Virtual plant environment

Operator Station (OS)



Emulation of AS

Software-in-the-loop

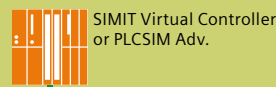

Hardware-in-the-loop

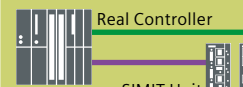

Signal level

Simulation of signals



Device level

Simulation of behavior
and reaction of drives
or sensors



Process level

Simulation of
technological behavior



Simulated process data and conditions

SIMIT Simulation

Bringing products to the market faster and with consistently high quality requires an optimized engineering workflow in the automation and the shortest possible assembly and commissioning times for new production lines. The SIMIT simulation software permits real-time simulation and emulation for comprehensive examination of automation solutions.

SIMIT simulates what SIMATIC automates

SIMIT is based on a uniform simulation platform that enables not only the virtual commissioning of the automation engineering of systems, machines and processes, but also realistic training environments for plant operators. This can be easily done directly at the workplace, even without requiring equipment or the need for in-depth knowledge of simulation. Either a real or virtual automation system is used for the control, for example, the SIMIT Virtual Controller.

SIMIT Virtual Controller instances can emulate the SIMATIC S7-300/S7-400 automation systems from the SIMATIC S7 and SIMATIC PCS 7 product range used in an automation project.

Many efficient tests for detection and elimination of potential faults can already be carried out before the real plant is even available, e.g.:

- Application of correct identifications
- Testing of interconnection or interlocking logic

In this manner it is possible to optimize the quality of the configuration process without a risk for the real plant.

Note:

SIMIT V10.3 can be used in combination with the following products:

- SIMATIC PCS 7
- SIMATIC PCS neo
- TIA Portal
- STEP 7

Notice: Please observe compatibility.

Benefits

- Testing and training environments without real hardware
- Virtual controllers for emulation of automation systems
- Flexible simulation and emulation environment for projects of any size
- Synchronized simulation and emulation in real-time or virtual time
- Testing of original automation project
- Higher quality for automation engineering configuration
- Reduced commissioning time and risk due to pretesting
- No simulation configuration in the automation project

Design

SIMIT runs on the latest notebooks or desktop computers with the Microsoft Windows operating system as well as on virtual systems (VMware ESXi Server V6.7). Flexible application is possible and integration is possible via open interfaces into the factory automation with SIMATIC S7 and SIMATIC WinCC or into the process automation with SIMATIC PCS 7 or SIMATIC PCS neo.

Since the models can be calculated in real time, SIMIT can be linked to the actual automation engineering ("hardware-in-the-loop"), using the SIMIT unit for connection via the PROFINET or PROFIBUS interfaces. A "software-in-the-loop" test is also possible through virtualization of the automation system using the S7-PLCSIM or S7-PLCSIM Advanced emulation software, or the integrated SIMIT Virtual Controller.

Interfacing to the real automation system is usually made via PROFIBUS DP or PROFINET IO, with interfaces (SIMIT units) which simulate the devices on PROFIBUS DP/PROFINET IO. A PRODAVE coupling can also be used for the MPI/DP or IE interface of the automation system for process data traffic with SIMIT (requirement: PRODAVE driver V6.1; not included in the product package).

Additional simulation models can be coupled to SIMIT:

- Data exchange via standardized interfaces such as OPC DA, OPC UA and shared memory
- Data exchange via one freely programmable external coupling (by the user)
- Synchronization via the remote control interface

In the case of coupling via the remote control interface, SIMIT can be either the master or client (slave) for other simulations. Using virtual time management, simulations can also be implemented faster or slower than in real-time.

SIMIT Simulation Platform

SIMIT can be perfectly adapted to individual requirements with four different software packages to suit the project size:

SIMIT Engineering S	4 000 simulation tags
SIMIT Engineering M	16 500 simulation tags
SIMIT Engineering L	200 000 simulation tags
SIMIT Engineering XL	1 000 000 simulation tags

SIMIT Engineering S - XL functional scope

- Portal view with workflow management for creation of simulation project
- Standard component library
- 3D viewer based on VRML (Virtual Reality Modeling Language)
- Interfaces for PROFIBUS DP, PROFINET IO and PRODAVE
- Interface for SIMIT Virtual Controller and OPC
- Trends and messages (TME)
- Scripting environment
- Editor for creating macro components (MCE)
- Editor for creating dynamic graphics and animations (DGE)
- Automatic Control Interface (ACI)
- Automatic generation of signal lists from SIMATIC Manager data
- Runtime for components developed with the Component Type Editor
- S7-PLCSIM, S7-PLCSIM Advanced, OPC and Remote Control interfaces
- Modification of simulation model during runtime
- Simulation in virtual time
- Engineering efficiency for SIMATIC PCS 7 (SMD)
- Automatic model generation based on templates
- Bulk engineering
- Shared memory interface for high-performance coupling
- XML interface for automatic generation of models and connections

SIMIT extension libraries

The following extension libraries make available specific technological components:

- SIMIT FLOWNET Library
Library for simulation of flow networks with homogeneous media (water/gases) including pressures, temperatures and flow rates.
- SIMIT CONTEC Library
Library for 2D simulation of material handling equipment.
- SIMIT CHEM BASIC Library
For simplified creation of simulations in the chemical and pharmaceutical industries. By connecting components of these libraries, a SIMIT model of a pipeline network (so-called flow network) is created and can be used to simulate the thermodynamic processes in pipeline networks. The flow networks then connect components with storage characteristics, e.g. containers. The CHEM BASIC library enables use of a special solution method in SIMIT that calculates the flow rates, pressures and specific enthalpies during simulation of pipeline networks.

SIMIT Component Type Editor

For creating library components according to your own requirements and functional expectations.

SIMATIC PCS 7 system software

Engineering system

Simulation

SIMIT Simulation > SIMIT Simulation Platform

Function

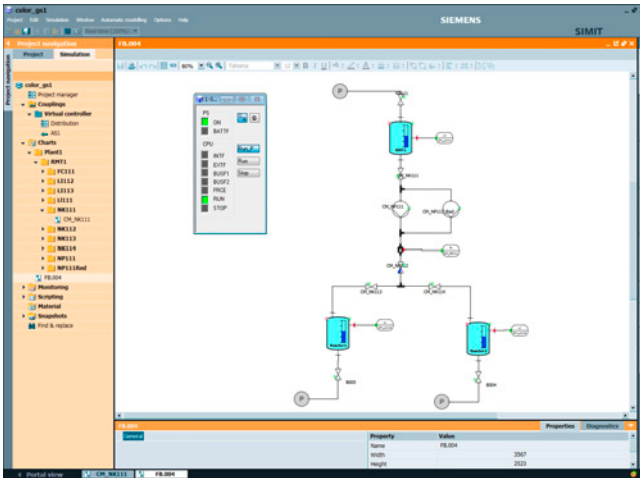

SIMIT, Graphical User Interface (GUI)

Component-based, signal flow oriented modeling of the plant is performed through the graphical user interface of SIMIT supported by expandable base libraries. For this, pre-defined components are selected from the library, placed on the graphic interface, connected with one another, and parameters are set. Beyond this, the simulation model can be generated with an export of the engineering data from COMOS. Special simulation skills are not required.

The efficient simulation is based on the abstraction at three different levels: Signals, devices (e.g. actuators and sensors) and technological response. Here, the technological response is represented mathematically and logically or by additive libraries.

Physical plant	Simulation with SIMIT	
Field equipment PROFIBUS DP ET 200M	Signals	Import (e.g. symbol table)
	Devices	Base library for • DRIVES • SENSORS
Technological plant/unit T2859	Technological response	Additive libraries • FLOWNET • CHEM BASIC
Production technology		• CONTEC

Abstraction levels of the simulation

The signal couplings can be created easily by importing the symbol table or a list of signal names. Files of the import/export wizard, Control Module (CM) files (SIMATIC PCS 7), or suitable Microsoft Excel files (SIMATIC S7) can be used together with simulation templates from the base library to simulate the devices.

Additive libraries support the simulation of the technological response and round off the SIMIT offer:

- FLOWNET can be used for rapid and simple simulation of the dynamic processes of pressures, flows and temperature distributions of water in pipeline networks.
- CONTEC can be used for simulation of material handling equipment.
- With CHEM BASIC you can simulate models of pipeline networks in the chemical and pharmaceutical industries quickly and easily. Using CHEM BASIC, the models from COMOS P&ID can be automatically generated via the generic import.

The user can also create custom components and templates that enable effective customer-specific modeling.

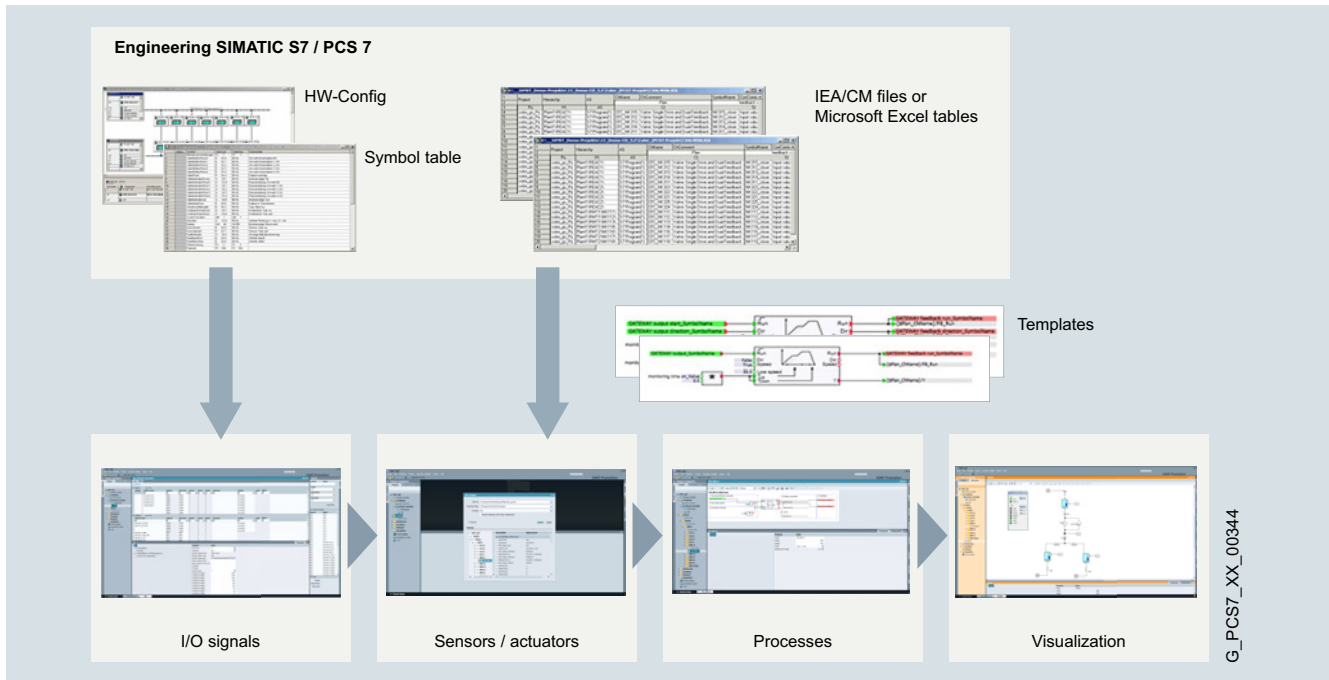
Function (continued)

Workflow to create a simulation

SIMIT supports two types of virtual commissioning:

Software in the loop: Pretesting without a physical plant

When SIMIT is used in conjunction with the Virtual Controller or coupled to the S7-PLCSIM or S7-PLCSIM Advanced emulation software, the automation function can be tested in advance in the engineering office without the physical hardware – from the sensor through the automation system and back down to the actuator.

The user program is loaded in SIMATIC Manager into the automation system emulated by the SIMIT Virtual Controller, S7-PLCSIM or S7-PLCSIM Advanced without modifications and started. It obtains the simulated I/O signals via the coupling of the emulated automation system from SIMIT.

Hardware in the loop: Factory Acceptance Test (FAT)

The physical automation systems are loaded with the user program for the Factory Acceptance Test (FAT). SIMIT simulates the I/O signals, instrumentation and field devices. The simulation values are sent as message frames to the automation systems via the hardware interfaces (simulation unit). When SIMIT also simulates the technological response of the plant, the FAT becomes a plant test. Commissioning can be performed on the virtual process in an early phase of the project.

SIMIT project handling

You or your customers require a simulation solution based on SIMIT and the automation (SIMATIC S7, SIMATIC PCS 7 and SPPA-T3000) with specific properties for Hardware-in-the-Loop or Software-in-the-Loop. We execute the projects for you and achieve the best results possible based on our decades of experience with simulation projects. We offer:

- Complete simulators and process models for virtual commissioning and training simulators
- High-precision process simulators for various industries
- Customer-specific simulation libraries

SIMIT consulting and training courses

You or your customers require support or training for a simulation project based on SIMIT and the automation (SIMATIC S7/PCS 7) with specific properties for Hardware-in-the-Loop or Software-in-the-Loop. To help you complete your task optimally, we can support and advise you during the corresponding phases of the automation project using our decades of experience in simulation projects. You can also have our experts support you with your simulation from the planning phase to project setup right up to automation testing. We offer:

- Pre-defined consulting packages
- Specific packages, depending on customer requirements
- Customer-specific trainings

SIMIT Rental components

The option of renting portfolio elements from the range of SIMIT products reduces the costs for a simulation environment. If these components are required for validation or testing of the automation for only a limited time, it is often more economical to rent them. The rental components are always supplied with the latest hardware and software versions. We offer:

- Rental licenses for SIMIT and SIMIT Virtual Controller
- Rental of SIMIT UNIT

If you are interested in this offer and would like to receive additional information, please contact:

Siemens AG
 Digital Industries
 Process Automation
 Solution, Engineering & Consulting
 DI PA SE&C SO SIM 1
 Horst Jäckisch
 Siemenspromenade 3
 91058 Erlangen
 Germany

Email: horst.jaeckisch@siemens.com

SIMATIC PCS 7 system software

Engineering system
Simulation

SIMIT Simulation > SIMIT Simulation Platform

Ordering data

Article No.

SIMIT software packages

Note: Use only in conjunction with valid license/dongle V10.3

SIMATIC License Carrier USB Stick	6DL8900-7XX00-0XB8-ZY01Y02
SIMATIC License Carrier DL	6DL8900-7XX00-0XH8-ZY01Y02
SIMATIC License USB Dongle	6DL8900-8XX00-0XB8-ZY01
SIMATIC License USB Dongle (Spare Part)	6DL8900-8XX01-0XB8-ZY01
SIMIT Simulation Platform Software Engineering S V10.3	6DL8913-0AK30-0AB5
SIMIT Simulation Platform Software Engineering M V10.3	6DL8913-0BK30-0AB5
SIMIT Simulation Platform Software Engineering L V10.3	6DL8913-0CK30-0AB5
SIMIT Simulation Platform Software Engineering XL V10.3	6DL8913-0DK30-0AB5
SIMIT Simulation Platform Software Engineering S DL V10.3	6DL8913-0AK30-0AH5
SIMIT Simulation Platform Software Engineering M DL V10.3	6DL8913-0BK30-0AH5
SIMIT Simulation Platform Software Engineering L DL V10.3	6DL8913-0CK30-0AH5
SIMIT Simulation Platform Software Engineering XL DL V10.3	6DL8913-0DK30-0AH5

Upgrades

SIMIT Simulation Platform Software Engineering S Upgrade V10.2 -> V10.3	6DL8913-0AK30-0AE5
SIMIT Simulation Platform Software Engineering M Upgrade V10.2 -> V10.3	6DL8913-0BK30-0AE5
SIMIT Simulation Platform Software Engineering L Upgrade V10.2 -> V10.3	6DL8913-0CK30-0AE5
SIMIT Simulation Platform Software Engineering XL Upgrade V10.2 -> V10.3	6DL8913-0DK30-0AE5
SIMIT Simulation Platform Software Engineering Conversion Pack S -> M V10.3	6DL8913-0BK30-0AD5
SIMIT Simulation Platform Software Engineering Conversion Pack M -> L V10.3	6DL8913-0CK30-0AD5
SIMIT Simulation Platform Software Engineering Conversion Pack L -> XL V10.3	6DL8913-0DK30-0AD5
SIMIT Simulation Platform Software Engineering S Upgrade V10.2 -> V10.3 DL	6DL8913-0AK30-0AK5
SIMIT Simulation Platform Software Engineering M Upgrade V10.2 -> V10.3 DL	6DL8913-0BK30-0AK5
SIMIT Simulation Platform Software Engineering L Upgrade V10.2 -> V10.3 DL	6DL8913-0CK30-0AK5
SIMIT Simulation Platform Software Engineering XL Upgrade V10.2 -> V10.3 DL	6DL8913-0DK30-0AK5
SIMIT Simulation Platform Software Engineering Conversion Pack S -> M DL V10.3	6DL8913-0BK30-0AJ5
SIMIT Simulation Platform Software Engineering Conversion Pack M -> L DL V10.3	6DL8913-0CK30-0AJ5
SIMIT Simulation Platform Software Engineering Conversion Pack L -> XL DL V10.3	6DL8913-0DK30-0AJ5

Article No.

Extension libraries

SIMIT Simulation Platform Software Component Type Editor	6DL8913-0EK20-0AB5
SIMIT Simulation Platform Software FLOWNET Library	6DL8913-0FK20-0AB5
SIMIT Simulation Platform Software CONTEC Library	6DL8913-0GK20-0AB5
SIMIT Simulation Platform Software CHEM BASE Library	6DL8913-0HK20-0AB5
SIMIT Simulation Platform Software Component Type Editor DL	6DL8913-0EK20-0AH5
SIMIT Simulation Platform Software FLOWNET Library DL	6DL8913-0FK20-0AH5
SIMIT Simulation Platform Software CONTEC Library DL	6DL8913-0GK20-0AH5
SIMIT Simulation Platform Software CHEM BASE Library DL	6DL8913-0HK20-0AH5

Software Update Service (SUS)

Note: Under this contract, you receive all current software versions for a period of 1 year. The contract is automatically extended by a further year unless canceled three months prior to expiration. Period of delivery and service: 1 year from date of invoice

SIMIT Simulation Software Engineering S	6DL8913-0AX00-0AL8
Software Update Service for Simulation Software Engineering S; subscription contract for 1 year with automatic renewal; requirement: current software version	
SIMIT Simulation Software Engineering M	6DL8913-0BX00-0AL8
Software Update Service for Simulation Software Engineering M; subscription contract for 1 year with automatic renewal; requirement: current software version	
SIMIT Simulation Software Engineering L	6DL8913-0CX00-0AL8
Software Update Service for Simulation Software Engineering L; subscription contract for 1 year with automatic renewal; requirement: current software version	
SIMIT Simulation Software Engineering XL	6DL8913-0DX00-0AL8
Software Update Service for Simulation Software Engineering XL; subscription contract for 1 year with automatic renewal; requirement: current software version	
SIMIT Simulation Software Engineering S DL	6DL8913-0AX00-0AV8
Software Update Service for Simulation Software Engineering S; subscription contract for 1 year with automatic renewal; requirement: current software version	
SIMIT Simulation Software Engineering M DL	6DL8913-0BX00-0AV8
Software Update Service for Simulation Software Engineering M; subscription contract for 1 year with automatic renewal; requirement: current software version	

Ordering data**Article No.**

SIMIT Simulation Software Engineering L DL Software Update Service for Simulation Software Engineering L; subscription contract for 1 year with automatic renewal; requirement: current software version	6DL8913-0CX00-0AV8
SIMIT Simulation Software Engineering XL DL Software Update Service for Simulation Software Engineering XL; subscription contract for 1 year with automatic renewal; requirement: current software version	6DL8913-0DX00-0AV8
Demonstration software Note: Limited functionality (see Product Information); no liability or warranty	
SIMIT Demo Version V10.3	Download in the Siemens Industry Online Support Portal
Consulting and training offers	
SIMIT consulting Consultation on analysis, design, project setup and test operation on a daily basis Customer-specific training: Software-in-the-loop simulation platform, hardware-in-the-loop simulation platform and SIMIT VC interfaces Type of delivery: Written contract	9AP1471-2AD00

More information

For additional information, refer to the Internet at <http://www.siemens.com/simit>.

SIMATIC PCS 7 system software

Engineering system

Simulation

SIMIT Simulation > SIMIT Unit

Overview

Bringing products to the market faster and with consistently high quality requires an optimized engineering workflow in the automation and the shortest possible assembly and commissioning times for new production lines. The SIMIT simulation software permits real-time simulation and emulation for comprehensive examination of automation solutions.

SIMIT simulates what SIMATIC automates

SIMIT is based on a uniform simulation platform that enables not only the virtual commissioning of the automation engineering of systems, machines and processes, but also realistic training environments for plant operators. This can be easily done directly at the workplace, even without requiring equipment or the need for in-depth knowledge of simulation. Either a real or virtual automation system can be used for the control.

Many efficient tests for detection and elimination of potential faults can already be carried out before the real plant is even available, e.g.:

- Application of correct identifications
- Testing of interconnection or interlocking logic

In this manner it is possible to optimize the quality of the configuration process without a risk for the real plant.

Benefits

- Testing and training environments with real hardware (CPU)
- Flexible simulation and emulation environment for projects of any size
- Synchronized simulation and emulation in real-time or virtual time
- Testing of original automation project
- Higher quality for automation engineering configuration
- Reduced commissioning time and risk due to pretesting
- No simulation configuration in the automation project

Design

Since the models can be calculated in real time, SIMIT can be linked to the actual automation engineering ("hardware-in-the-loop"), using the SIMIT unit for connection via the PROFINET or PROFIBUS interfaces. The SIMIT units simulate the devices on PROFIBUS DP/PROFINET IO while the simulation values, influenced by SIMIT, are sent as message frames to the

automation systems via the hardware interfaces (simulation unit). When SIMIT also simulates the technological response of the system it becomes possible to carry out a full system test, making it possible to perform commissioning on the virtual model in an early phase of the project.

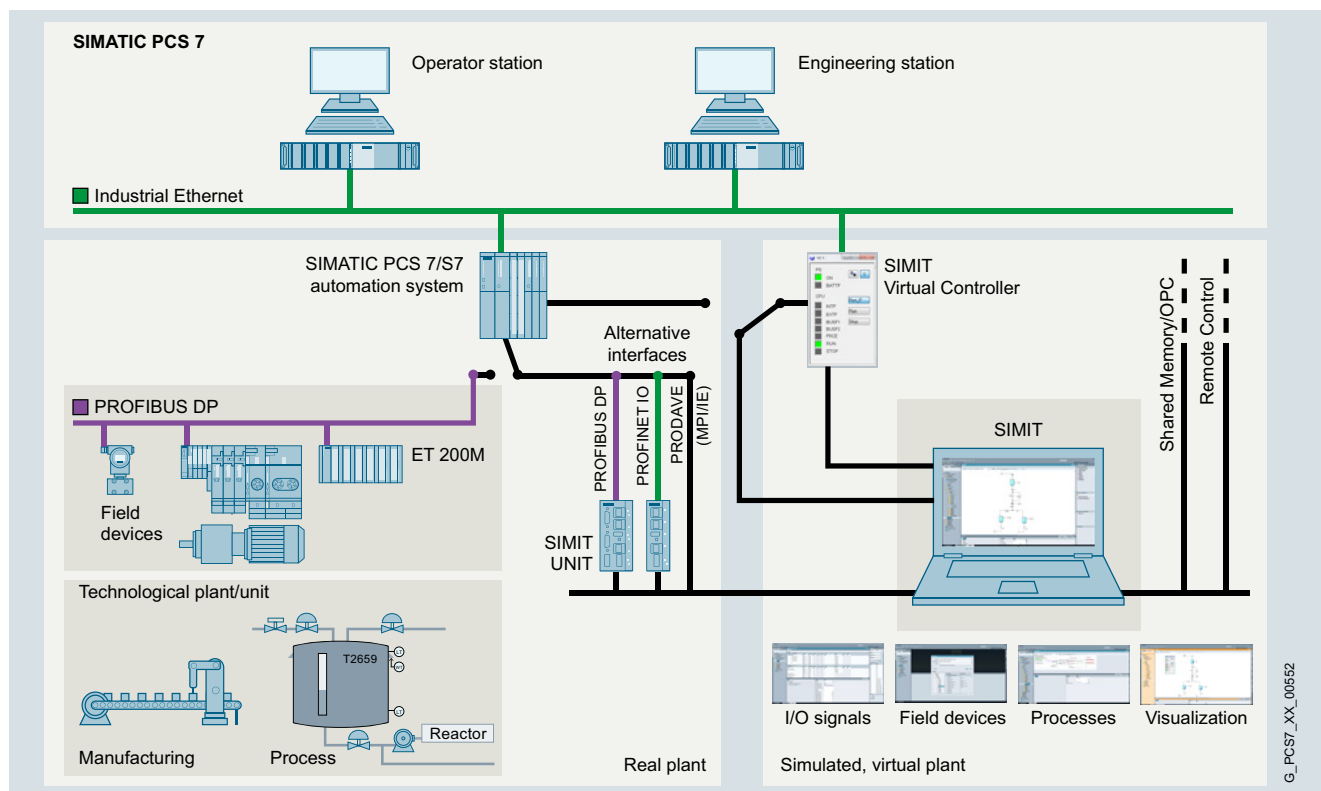

SIMIT Simulation Platform for PCS 7

Function

Coupling with SIMIT allows an efficient engineering workflow for hardware-in-the-loop simulation. The execution of load and safety tests prior to actual commissioning adds greater protection for personnel and machines/plants and a time/cost reduction through early error detection.

The following products are offered for simulating PROFINET and PROFIBUS:

- SIMIT UNIT PB 2
- SIMIT UNIT PN 128
- SIMIT UNIT PN 256

PROFIBUS simulation

Using the SIMIT UNIT PB hardware interface, you can simulate the complete behavior of up to 125 PROFIBUS slaves on the field bus, reaction-free and in real time.

PROFINET simulation

Using the SIMIT UNIT PN hardware interface, you can simulate the complete behavior of up to 256 PROFINET I/O devices on the field bus, reaction-free and in real time.

Ordering data

Article No.

SIMIT software packages

Note: Use only in conjunction with valid license/dongle V10.3

SIMIT UNIT PB 2

2-channel interface for SIMIT for simulation of PROFIBUS DP slaves in a DP master system; maximum of 125 DP slaves per channel

9AE4122-2AA00

SIMIT UNIT PN 128

1-channel interface for SIMIT for simulation of 128 PROFINET I/O devices

9AE4120-2AA00

SIMIT UNIT PN 256

1-channel interface for SIMIT for simulation of 256 PROFINET I/O devices

9AE4120-2AB00

Demonstration software

Note: Limited functionality (see Product Information); no liability or warranty

SIMIT Demo Version V10.3

Download in the Siemens Industry Online Support Portal

More information

For additional information, refer to the Internet at <http://www.siemens.com/simit>.

SIMATIC PCS 7 system software

Engineering system

Simulation

SIMIT Simulation > Virtual Controller

Overview

Bringing products to the market faster and with consistently high quality requires an optimized engineering workflow in the automation and the shortest possible assembly and commissioning times for new production lines. The SIMIT simulation software permits real-time simulation and emulation for comprehensive examination of automation solutions.

SIMIT simulates what SIMATIC automates

SIMIT is based on a uniform simulation platform that enables not only the virtual commissioning of the automation engineering of systems, machines and processes, but also realistic training environments for plant operators. This can be easily done directly at the workplace, even without requiring equipment or the need for in-depth knowledge of simulation. Either a real or virtual automation system is used for the control, for example, the SIMIT Virtual Controller.

SIMIT Virtual Controller instances can emulate the SIMATIC S7-300/S7-400 automation systems from the SIMATIC S7 and SIMATIC PCS 7 product range used in an automation project.

Many efficient tests for detection and elimination of potential faults can already be carried out before the real plant is even available, e.g.:

- Application of correct identifications
- Testing of interconnection or interlocking logic

In this manner it is possible to optimize the quality of the configuration process without a risk for the real plant.

Benefits

- Testing and training environments without real hardware
- Virtual controllers for emulation of automation systems
- Flexible simulation and emulation environment for projects of any size
- Synchronized simulation and emulation in real-time or virtual time
- Testing of original automation project
- Higher quality for automation engineering configuration
- Reduced commissioning time and risk due to pretesting
- No simulation configuration in the automation project

Design

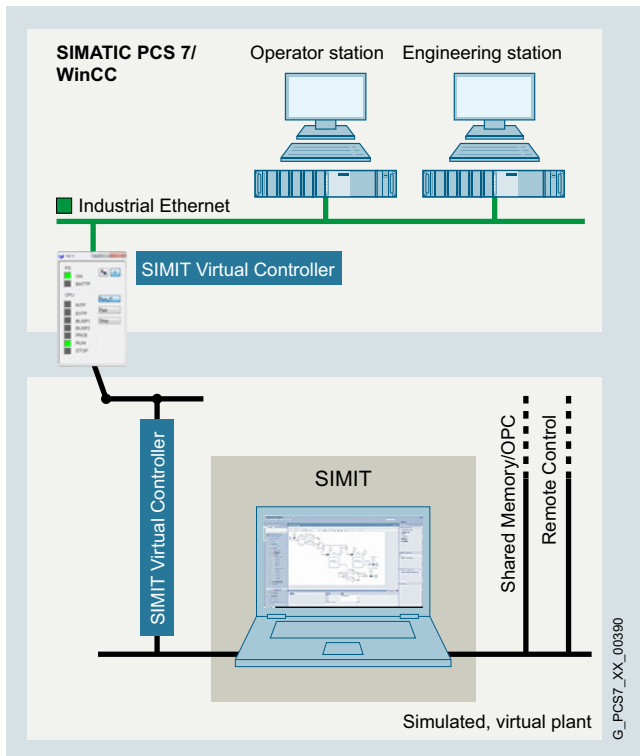

SIMIT Virtual Controller

You can use SIMIT Virtual Controllers to implement testing and training systems of any size without physical hardware. This means you can test the original automation programs completely before commissioning and train operators in the practical work with the configured automation functions.

To do so, the SIMIT Engineering S–XL software package are extended with cumulative SIMIT Virtual Controller instances. SIMIT Virtual Controller instances emulate the SIMATIC S7-300, S7-400 and S7-410 automation systems used in a SIMATIC S7 or SIMATIC PCS 7 automation project on the latest notebooks or desktop computers with the Microsoft Windows operating system, or in a virtual environment (ESXi Server V6.7).

The following products are offered for emulation:

- SIMIT Virtual Controller software for 1 controller
- SIMIT Virtual Controller software for 5 controllers

Specification/Configuration

- Almost unlimited number of SIMIT Virtual Controllers, distributed over multiple computers (max. 32 virtual controllers per SIMIT Engineering)
- One SIMIT Engineering S–XL is required for each simulation system (not included in the SIMIT Virtual Controller scope of supply)

Function

When SIMIT is used in conjunction with the Virtual Controller, the automation function can be tested in advance in the engineering office without the physical hardware – from the sensor through the automation system and back down to the actuator.

The user program is loaded in SIMATIC Manager into the automation system emulated by the SIMIT Virtual Controller without modifications and started. It obtains the simulated I/O signals via the coupling of the emulated automation system from SIMIT.

SIMIT Virtual Controller

SIMIT Virtual Controllers are high-performance emulation systems for the SIMATIC S7-300, S7-400 and S7-410 automation systems which are integrated in SIMIT.

Special features

- High degree of reusability of the information from the engineering system
- SIMIT Virtual Controller are synchronized with each other
- The automation system is loaded by means of the engineering system as in the actual automation system
- Runtime is independent of the engineering system
- Automation programs can run in virtual time (faster or slower than in real-time)
- Current states of the SIMIT Virtual Controller and the SIMIT simulation model can be saved in the shared snapshot

System and communication functions

For detailed information on supported SIMATIC S7/SIMATIC PCS 7 system and communication functions as well as communication services, see the SIMIT V10.3 manual: (manual not yet available)

Note:

The SIMIT Virtual Controller does not support, among others:

- BRAUMAT Classic
- Data record communication
- Named Connections via RFC1006
- Communication blocks TSEND, TREC V

SIMATIC PCS 7 system softwareEngineering system
Simulation**SIMIT Simulation > Virtual Controller****Ordering data****Article No.****Article No.****SIMIT software packages**

Note: Use only in conjunction with valid license/dongle V10.3

SIMATIC License Carrier USB Stick 6DL8900-7XX00-0XB8-ZY01Y02**SIMATIC License Carrier DL** 6DL8900-7XX00-0XH8-ZY01Y02**SIMATIC License USB Dongle** 6DL8900-8XX00-0XB8-ZY01**SIMATIC License USB Dongle (Spare Part)** 6DL8900-8XX01-0XB8-ZY01**SIMIT Virtual Controller Software Full V10.3 (1 controller)** 6DL8913-0JK30-0AB5**SIMIT Virtual Controller Software Full V10.3 (1 controller) DL** 6DL8913-0JK30-0AH5**SIMIT Virtual Controller Software Full V10.3 (5 controllers)** 6DL8913-0KK30-0AB5**SIMIT Virtual Controller Software Full V10.3 (5 controllers) DL** 6DL8913-0KK30-0AH5**SIMIT Virtual Controller Software 300 V10.3 (1 controller)** 6DL8913-0NK30-0AB5**SIMIT Virtual Controller Software 300 V10.3 (1 controller) DL** 6DL8913-0NK30-0AH5**SIMIT Virtual Controller Software 300 V10.3 (5 controllers)** 6DL8913-0PK30-0AB5**SIMIT Virtual Controller Software 300 V10.3 (5 controller) DL** 6DL8913-0PK30-0AH5**SIMIT Virtual Controller Software Entry / SIS V10.3 (1 controller)** 6DL8913-0QK30-0AB5**SIMIT Virtual Controller Software Entry / SIS V10.3 (1 controller) DL** 6DL8913-0QK30-0AH5**SIMIT Virtual Controller Software Entry / SIS V10.3 (5 controllers)** 6DL8913-0RK30-0AB5**SIMIT Virtual Controller Software Entry / SIS V10.3 (5 controllers) DL** 6DL8913-0RK30-0AH5**Upgrades****SIMIT Virtual Controller Software Full (1 controller) Upgrade V10.2 > V10.3** 6DL8913-0JK30-0AE5**SIMIT Virtual Controller Software Full (1 controller) Upgrade V10.2 > V10.3 DL** 6DL8913-0JK30-0AK5**SIMIT Virtual Controller Software Full (5 controllers) Upgrade V10.2 > V10.3** 6DL8913-0KK30-0AE5**SIMIT Virtual Controller Software Full (5 controllers) Upgrade V10.2 > V10.3 DL** 6DL8913-0KK30-0AK5**SIMIT Virtual Controller Software 300 (1 controller) Upgrade V10.2 > V10.3** 6DL8913-0NK30-0AE5**SIMIT Virtual Controller Software 300 (1 controller) Upgrade V10.2 > V10.3 DL** 6DL8913-0NK30-0AK5**SIMIT Virtual Controller Software 300 (5 controllers) Upgrade V10.2 > V10.3** 6DL8913-0PK30-0AE5**SIMIT Virtual Controller Software 300 (5 controllers) Upgrade V10.2 > V10.3 DL** 6DL8913-0PK30-0AK5**SIMIT Virtual Controller Software Entry / SIS (1 controller) Upgrade V10.2 > V10.3** 6DL8913-0QK30-0AE5**SIMIT Virtual Controller Software Entry / SIS (1 controller) Upgrade V10.2 > V10.3 DL** 6DL8913-0QK30-0AK5**SIMIT Virtual Controller Software Entry / SIS (1 controller) Upgrade V10.2 > V10.3** 6DL8913-0RK30-0AE5**SIMIT Virtual Controller Software Entry / SIS (1 controller) Upgrade V10.2 > V10.3 DL** 6DL8913-0RK30-0AK5**Software Update Service (SUS)**

Note: Under this contract, you receive all current software versions for a period of 1 year. The contract is automatically extended by a further year unless canceled three months prior to expiration. Period of delivery and service: 1 year from date of invoice

SIMIT Virtual Controller Software (1 controller) 6DL5260-0DA00-2YL8

Software Update Service for Virtual Controller Software Full 1VC; subscription contract for 1 year, with automatic renewal; requirement: current software version

SIMIT Virtual Controller Software Full (1 controller) DL 6DL5260-0DA00-2YV8

Software Update Service for Virtual Controller Software Full 1VC; subscription contract for 1 year, with automatic renewal; requirement: current software version

SIMIT Virtual Controller Software (5 controllers) 6DL5260-0DB00-2YL8

Software Update Service for Virtual Controller Software Full 5VC; subscription contract for 1 year, with automatic renewal; requirement: current software version

SIMIT Virtual Controller Software Full (5 controllers) DL 6DL5260-0DB00-2YV8

Software Update Service for Virtual Controller Software Full 5VC; subscription contract for 1 year, with automatic renewal; requirement: current software version

SIMIT Virtual Controller Software 300 (1 controller) 6DL8913-0NX00-0AL8

Software Update Service for Virtual Controller Software Full 300 1VC; subscription contract for 1 year, with automatic renewal; requirement: current software version

SIMIT Virtual Controller Software 300 (1 controller) DL 6DL8913-0NX00-0AV8

Software Update Service for Virtual Controller Software Full 300 1VC; subscription contract for 1 year, with automatic renewal; requirement: current software version

SIMIT Virtual Controller Software 300 (5 controllers) 6DL8913-0PX00-0AL8

Software Update Service for Virtual Controller Software Full 300 5VC; subscription contract for 1 year, with automatic renewal; requirement: current software version

SIMIT Virtual Controller Software 300 (5 controllers) DL 6DL8913-0PX00-0AV8

Software Update Service for Virtual Controller Software Full 300 5VC; subscription contract for 1 year, with automatic renewal; requirement: current software version

Ordering data**Article No.**

SIMIT Virtual Controller Software Entry / SIS (1 controller) Software Update Service for Virtual Controller Software Entry / SIS 1VC; subscription contract for 1 year, with automatic renewal; requirement: current software version	6DL8913-0QX00-0AL8
SIMIT Virtual Controller Software Entry / SIS (1 controller) DL Software Update Service for Virtual Controller Software Entry / SIS 1VC; subscription contract for 1 year, with automatic renewal; requirement: current software version	6DL8913-0QX00-0AV8
SIMIT Virtual Controller Software Entry / SIS (5 controllers) Software Update Service for Virtual Controller Software Entry / SIS 5VC; subscription contract for 1 year, with automatic renewal; requirement: current software version	6DL8913-0RX00-0AL8
SIMIT Virtual Controller Software Entry / SIS (5 controllers) DL Software Update Service for Virtual Controller Software Entry / SIS 5VC; subscription contract for 1 year, with automatic renewal; requirement: current software version	6DL8913-0RX00-0AV8
Demonstration software Note: Limited functionality (see Product Information); no liability or warranty	
SIMIT Demo Version V10.3	Download in the Siemens Industry Online Support Portal

More information

For additional information, refer to the Internet at <http://www.siemens.com/simit>.

SIMATIC PCS 7 system software

Notes

3

SIMATIC PCS 7 Plant Automation Accelerator



4/2

SIMATIC PCS 7
Plant Automation Accelerator

SIMATIC PCS 7 system software

SIMATIC PCS 7 Plant Automation Accelerator

Overview

4

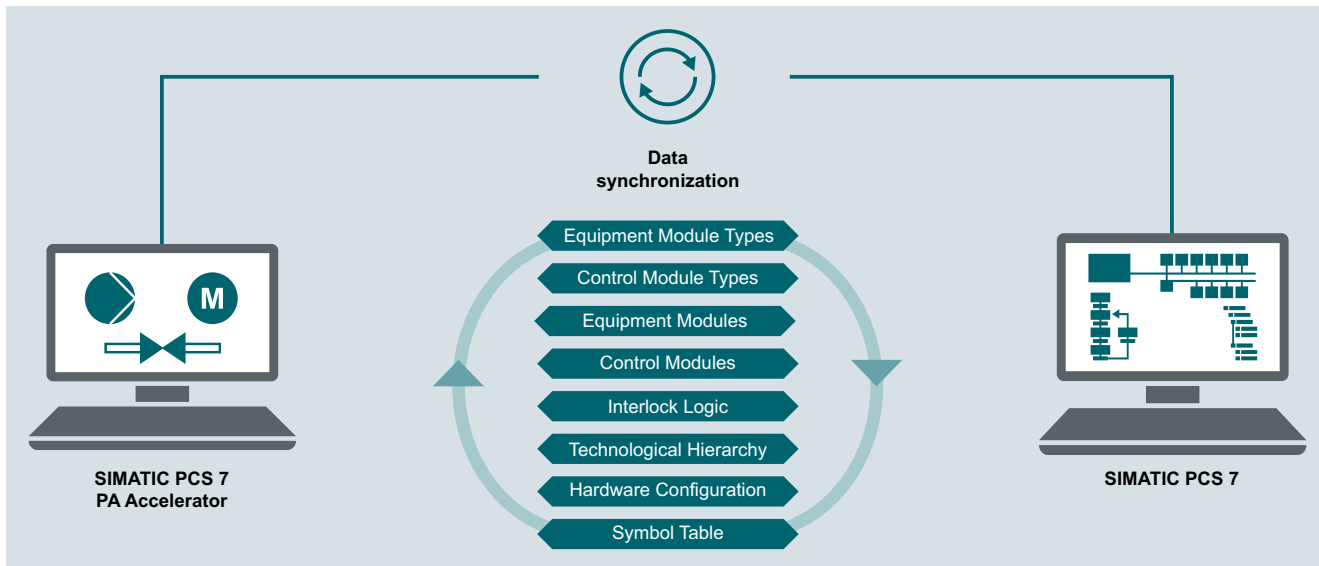

Data exchange between SIMATIC PCS 7 Plant Automation Accelerator and SIMATIC PCS 7

Performance in engineering

With regard to planning and engineering, performance can be equated with minimizing time and costs. "Integrated Engineering" offers an unique approach here: an integrated planning workflow from the description of the process to the automation program.

Using the SIMATIC PCS 7 Plant Automation Accelerator (PAA), both engineers and planning offices and end customers can significantly reduce their configuration and commissioning costs while simultaneously improving the quality of engineering.

PAA expands the functionality for plant configuration and documentation. To improve efficiency in plant engineering, the PAA provides support generating offer with a plant topology plan and the bills of materials to the automatic generation of SIMATIC PCS 7 data from electrical and function plans.

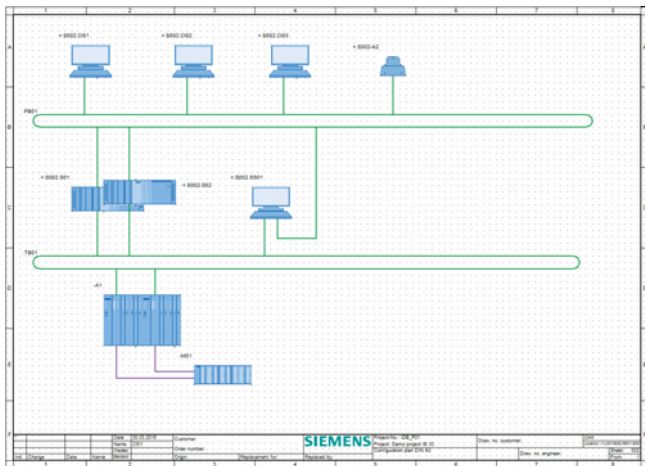

Plant topology plan

SIEMENS		Bill of material - without bundles		Project	Demo project IE IO
		Cabinet		Project-No.	IDB_PD1
				Building	+0L001
				P&ID no.	
TAG-No.					
Location	+0L0010001.R001.S001	Unit			
1	Name Article description				MLFB
2	0 Rack, UR2				6ES7 400-1JA01-0AA0
3	1 Rack, UR2				6ES7 400-1JA01-0AA0
4	0 Profile rail, 483mm				6ES7 195-1GA00-0XA0
5	0 Profile rail, 483mm				6ES7 195-1GA00-0XA0
6	0 Profile rail, 483mm				6ES7 195-1GA00-0XA0
7	0 Profile rail, 483mm				6ES7 195-1GA00-0XA0
8	0 Profile rail, 483mm				6ES7 195-1GA00-0XA0
9	1 PS 405, 10A, DC 24/48/60V, DC 5V/10A				6ES7 405-0KA02-0AA0
10	3 CPU 410-5H				6ES7 410-5HX08-0AB0
11	5 CP 443-5 Ext				6GK7 443-5DX05-0XE0
12	1 PS 405, 10A, DC 24/48/60V, DC 5V/10A				6ES7 405-0KA02-0AA0
13	3 CPU 410-5H				6ES7 410-5HX08-0AB0
14	5 CP 443-5 Ext				6GK7 443-5DX05-0XE0
15	0 PS 307 AC 120/230V, DC 24V/2A				6ES7 307-1BA01-0AA0
16	2 IM 153-2 HF				6ES7 153-2BA02-0XB0
17	01 Bus unit, 2x40mm				6ES7 195-7HB00-0XA0
18	02 Bus unit, 2x40mm				6ES7 195-7HB00-0XA0
19	03 Bus unit, 2x40mm				6ES7 195-7HB00-0XA0
20	04 Bus unit, 2x40mm				6ES7 195-7HB00-0XA0
21	0 PS 307 AC 120/230V, DC 24V/2A				6ES7 307-1BA01-0AA0
22	2 IM 153-2 HF				6ES7 153-2BA02-0XB0
23	01 Bus unit, 2x40mm				6ES7 195-7HB00-0XA0
24	02 Bus unit, 2x40mm				6ES7 195-7HB00-0XA0
25	03 Bus unit, 2x40mm				6ES7 195-7HB00-0XA0
26	04 Bus unit, 2x40mm				6ES7 195-7HB00-0XA0
27	0 PS 307 AC 120/230V, DC 24V/2A				6ES7 307-1BA01-0AA0
28	2 IM 153-2 HF				6ES7 153-2BA02-0XB0
29	01 Bus unit, 2x40mm				6ES7 195-7HB00-0XA0
30	02 Bus unit, 2x40mm				6ES7 195-7HB00-0XA0
31	03 Bus unit, 2x40mm				6ES7 195-7HB00-0XA0
32	04 Bus unit, 2x40mm				6ES7 195-7HB00-0XA0
33	0 PS 307 AC 120/230V, DC 24V/2A				6ES7 307-1BA01-0AA0
34	2 IM 153-2 HF				6ES7 153-2BA02-0XB0
35	01 Bus unit, 2x40mm				6ES7 195-7HB00-0XA0
36	02 Bus unit, 2x40mm				6ES7 195-7HB00-0XA0
37	03 Bus unit, 2x40mm				6ES7 195-7HB00-0XA0
38	04 Bus unit, 2x40mm				6ES7 195-7HB00-0XA0
39	0 PS 307 AC 120/230V, DC 24V/2A				6ES7 307-1BA01-0AA0
40	2 IM 153-2 HF				6ES7 153-2BA02-0XB0
41	01 Bus unit, 2x40mm				6ES7 195-7HB00-0XA0
42	02 Bus unit, 2x40mm				6ES7 195-7HB00-0XA0
43	03 Bus unit, 2x40mm				6ES7 195-7HB00-0XA0
44	04 Bus unit, 2x40mm				6ES7 195-7HB00-0XA0
45	03 Synchronization module up to 10m				6ES7 960-1AA06-0XA0
46	04 Synchronization module up to 10m				6ES7 960-1AA06-0XA0

Bills of materials

Overview (continued)

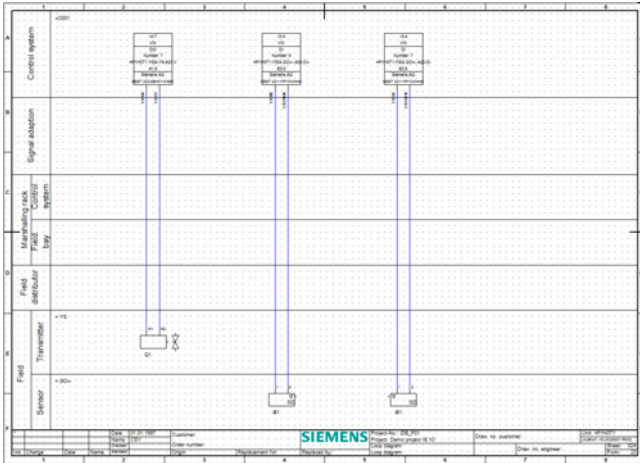

Electrical planning

If electrical planning has been carried out with planning tools from other providers, this data can be imported in Microsoft Excel format using signal or process tag lists.

Benefits

- Reduced customizing and planning time with integrated processes for engineering, automation and operation
- Shorter project terms with consistent and simple data synchronization between engineering and automation
- Increased plant availability with error-free data transfer and system documentation that is always up-to-date
- Increased engineering efficiency and cost reductions with optimized change management

Function

Data changes can be undertaken at both ends and exchanged bidirectionally. If the user triggers data exchange, all changes are listed in a comparison and the user can select which changes are to be applied.

The automation hardware, the automation software and their interconnections are generated automatically when signal lists are exported from an external plan.

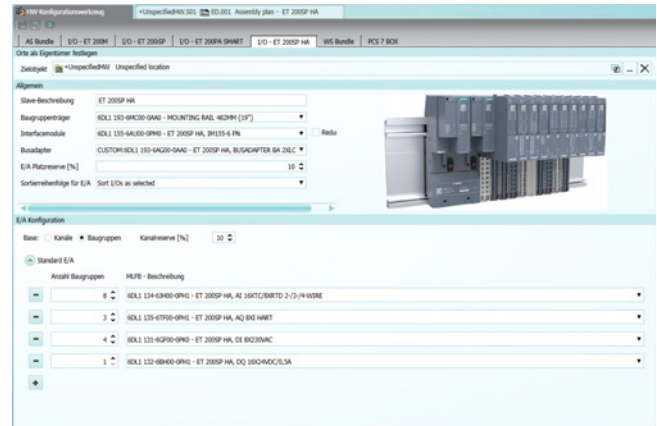

Engineering wizard

Engineering wizards efficiently support hardware engineering. The PAA uses the complete basic functional scope of COMOS products with

- User administration
- Change management with working layers
- Scalability

The PAA automatically generates hardware and software documents for redocumentation of existing SIMATIC PCS 7 projects.

Label	Module description	Module	Used channels	Free channels
1	ET 200SP HA, DI16xDC24V/0.5A	DI16xDC24V/0.5A	-	-
2	ET 200SP HA, BUSADAPTER BA 2xDC	BUSADAPTER BA 2xDC	-	-
3	ET 200SP HA, AI 16xDC24V/0.5A	AI 16xDC24V/0.5A	0	16 (100 %)
4	ET 200SP HA, AI 16xDC24V/0.5A	AI 16xDC24V/0.5A	0	16 (100 %)
5	ET 200SP HA, AI 16xDC24V/0.5A	AI 16xDC24V/0.5A	0	16 (100 %)
6	ET 200SP HA, AI 16xDC24V/0.5A	AI 16xDC24V/0.5A	0	16 (100 %)
7	ET 200SP HA, AO 12x12Bit	AO 12x12Bit	0	12 (100 %)
8	ET 200SP HA, DI 16xDC24V/0.5A	DI 16xDC24V/0.5A	0	16 (100 %)
9	ET 200SP HA, DI 16xDC24V/0.5A	DI 16xDC24V/0.5A	0	16 (100 %)
10	ET 200SP HA, DI 16xDC24V/0.5A	DI 16xDC24V/0.5A	0	16 (100 %)
11	ET 200SP HA, DI 16xDC24V/0.5A	DI 16xDC24V/0.5A	0	16 (100 %)

Assembly plan

SIMATIC PCS 7 system software

SIMATIC PCS 7 Plant Automation Accelerator

Function (continued)

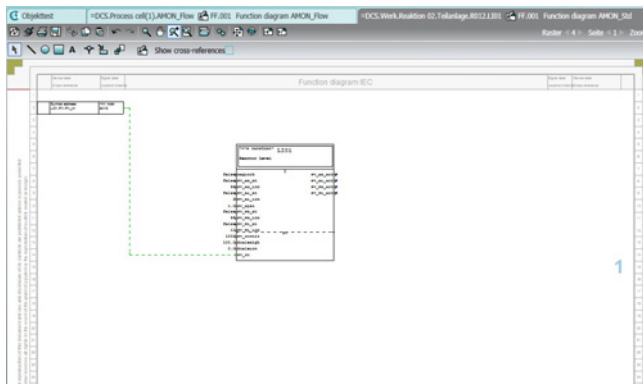

Function diagram

The PAA is thus the first product to offer the direct connection of a DCS system (SIMATIC PCS 7) to an automation-neutral tool for plant engineering (COMOS) and thus represents a significant step towards the digital plant.

More information

Ordering information

The SIMATIC PCS 7 Plant Automation Accelerator (PAA) cannot be ordered through this catalog or the Industry Mall. Please get in touch with your regional contact.

Operator System



5/2	Introduction
5/5	OS software
5/6	OS standard software for single station/server/client
5/11	SFC visualization
5/12	OS redundancy
5/18	Operator control and monitoring via Web
5/18	SIMATIC PCS 7 Web Server

SIMATIC PCS 7 system software

Operator system

Introduction

Overview

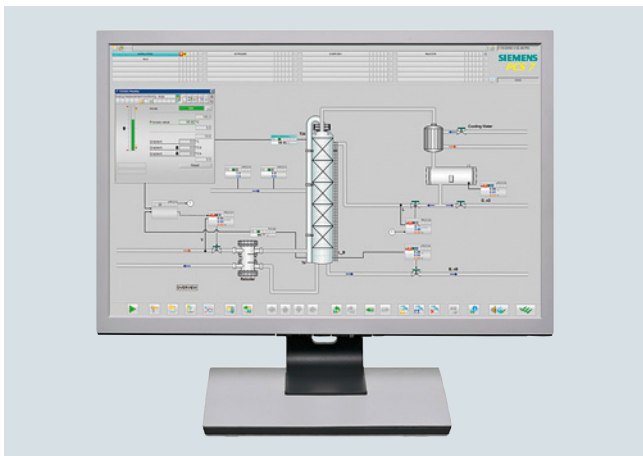

The operator system of the SIMATIC PCS 7 process control system allows easy and safe control of the process by the operating personnel. The operator can observe the process sequence by means of various views and intervene to control the system when necessary.

The operator system architecture is extremely variable and can be flexibly adapted to different plant architectures and customer requirements.

The basis is perfectly coordinated operator stations for single-user systems (OS Single Stations) and for multi-user systems with client/server architecture.

The system software of the operator stations can be expanded by cumulative SIMATIC PCS 7 OS Runtime licenses for 100, 1 000 and 5 000 process objects (PO) up to the following configuration limits:

- 8 500 POs per OS Single Station
- 12 000 POs per OS Server (with client/server architecture)

Benefits

- High-performance operator stations based on versatile, rugged SIMATIC PCS 7 Industrial Workstations, optimized for use in industrial environments
- Flexible, modular architecture with scalable hardware and software components for
 - Single-user system (OS single station) with up to 8 500 process objects
 - Flat system configurations based on a redundant OS Single Station pair, expandable with reference stations to up to 8 OS Single Stations.
 - Client/server multi-user systems with up to 18 OS servers/pairs of servers for every 12 000 process objects (PO) and up to 40 OS clients
- High-performance archiving system based on Microsoft SQL Server with short-term archives and integrated archive backup, can be optionally expanded for long-term archiving with the Process Historian
- Self-diagnostics of important OS server applications
- Integration of modifications without interrupting runtime operations, and online testing through selective loading of redundant servers
- Optimized AS/OS communication:
 - data transmission only following change in data, independent of AS reply cycle; suppression of nuisance alarms
- User-friendly process control and high operational reliability with support of multi-screen technology
- Extended status displays through combination of status/analog values with alarm information
- Highly effective alarm management provides support for operating personnel
 - Assignment of priorities with up to 16 message priorities as additional attribute to the message classes
 - Visual and audible suppression of messages which are irrelevant to a specific operating state (dynamic or manual)
 - Suppression of sensor/actuator alarms during startup or in event of malfunction
- Centralized user administration with access control and electronic signature
- Sign-of-life monitoring for subordinate systems connected to the plant bus
- System-wide time synchronization based on UTC (Universal Time Coordinated)

Design

All operator stations are based on modern SIMATIC PCS 7 Industrial Workstations optimized for use as OS Single Station, OS Client or OS Server. The SIMATIC PCS 7 Industrial Workstations are suitable for use in harsh industrial environments and are characterized by powerful industrial PC technology combined with a Windows Desktop operating system (Windows 10 LTSC 2019) or a Windows Server operating system (Windows Server 2019) from Microsoft. Standard components and interfaces from the PC world offer generous scope for system-, customer- or sector-specific options and expansions.

The operating system and the following ES/OS software of the SIMATIC PCS 7 process control system are factory installed:

- Single station: PCS 7 Engineering Software for AS/OS including OS Runtime software
- Server: PCS 7 OS Software Server
- Client: PCS 7 OS Software Client

You only need the corresponding software licenses in order to use the pre-installed SIMATIC PCS 7 software.

Depending on the customer's particular requirements, you can equip an OS Single Station, OS Server or OS Client with optional hardware components, such as:

- Hardware and software components for redundant operation
- Signal module for audible and visual signaling of messages
- Smart card reader for access protection
- Multi-monitor graphics card for operation of up to 4 process monitors
- Process monitors for office and industrial environments

See section "Industrial Workstation/IPC" for ordering data and detailed information on the product package and technology of the SIMATIC PCS 7 Industrial Workstations.

Single-user system (OS Single Station)

In a single station system architecture, all operation and monitoring functions for a complete project (plant/unit) are concentrated in one station.

This OS Single Station can be operated on the plant bus together with other single-user systems or parallel to a multi-user system. Redundant operation of two OS Single Stations (SIMATIC PCS 7 Single Station Redundancy) and their expansion with reference stations into a flat system configuration with up to 8 OS Single Stations is also possible.

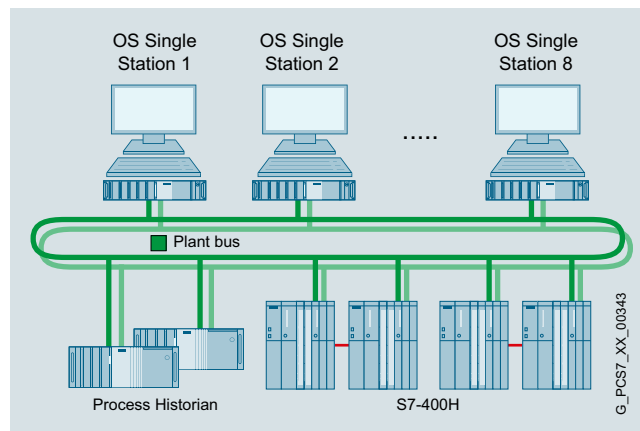

Example of a flat system architecture

Depending on the version (IE or BCE), the OS Single Station can be connected to the Industrial Ethernet plant bus via one of the following network components:

- IE: CP 1623 communication module (pre-installed in SIMATIC PCS 7 Industrial Workstation) for communication with max. 64 automation systems
- BCE: Standard Ethernet network adapter (10/100/1000 Mbps) and Basic Communication Ethernet for communication with up to 8 automation systems (no redundancy stations)

Two 10/100/1000 Mbps Ethernet RJ45 ports are always integrated onboard for use as desired.

The OS engineering is located as standard in a separate engineering system.

Multi-user system with client/server architecture

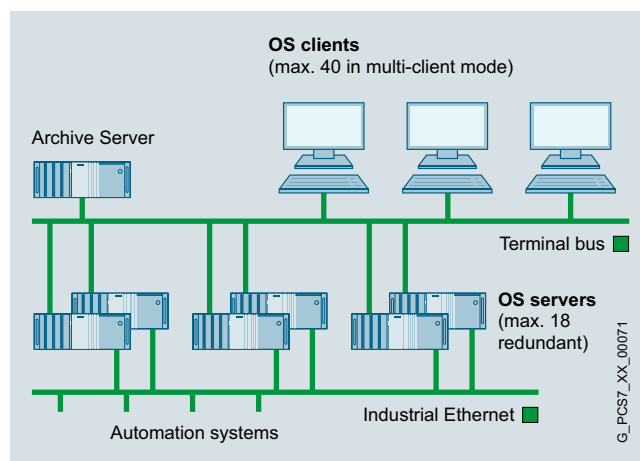

Example of multi-user system

A multiple station system consists of operator stations (OS Clients) which receive data (project data, process values, archive data, alarms and messages) from one or more OS Servers over a terminal bus. The terminal bus can share the transmission medium with the plant bus or it can be designed as a separate bus (Industrial Ethernet with TCP/IP).

SIMATIC PCS 7 system software

Operator system

Introduction

Design (continued)

In this architecture, redundant OS Servers may be set up to meet higher availability requirements. Critical applications running on the OS Server are monitored by Health Check for software faults. If a fault is detected, switchover to the redundant system is triggered. Synchronization of the redundant OS Servers takes place automatically and at high speed.

OS Clients can access the data of not only one OS Server/server pair, but from several OS Servers/pairs of servers simultaneously (multi-client mode). This makes it possible to divide a plant into technological units and to distribute the data accordingly to several OS Servers/pairs of servers. In addition to scalability, the advantage of distributed systems is the ability to decouple plant areas from each other, which results in higher availability.

The OS Servers are designed in addition with client functions which permit them to access the data (archives, messages, tags, variables) from the other OS Servers of the multi-user system. This means that process displays on one OS Server can also be linked with variables on other OS Servers (area-independent displays).

Like the OS Single Stations, the OS Servers can be connected to the Industrial Ethernet plant bus using one of the following network components:

- IE: CP 1623 communication module (pre-installed in SIMATIC PCS 7 Industrial Workstation) for communication with max. 64 automation systems
- BCE: Standard Ethernet network adapter (10/100/1000 Mbps) and Basic Communication Ethernet for communication with up to 8 automation systems (no redundancy stations)

Two 10/100/1000 Mbps Ethernet RJ45 ports onboard can be used to connect to the terminal bus.

Data archiving

The OS Single Stations and OS Servers already include a high-performance archiving system, configurable in runtime, based on Microsoft SQL Server with cyclic archives for short-term archiving of process values (typically for 1 to 4 weeks) and messages/events (typically for 2 months). This may be combined with an external data archiving system for long-term data storage. The Process Historian offered in the section "Process data archiving and reporting" is available for this purpose.

The archive data can be saved on all storage media supported by the operating system, for example on a NAS drive.

Technical specifications

Definitions

OS tag	An OS tag or parameter is a defined memory location required for operator control and monitoring with the Operator System; values can be written into it and read from it (e.g. setpoint, actual value etc.).
Process object (PO)	A process object (PO) is synonymous with a block that can be operated and monitored. A PO usually has several OS tags (which can be operated and monitored). The number of OS tags differs depending on the block type. For example, motors or valves require fewer tags than closed-loop controls or dosing units.
Licensing	Licensing and license verification of the OS software for SIMATIC PCS 7 are based on the process objects. Every block fulfilling the following criteria is counted and calculated as a PO: <ul style="list-style-type: none"> • The block is not a driver block. • The block can be operated and monitored. • This block can handle messages. The license verification also takes into account the sum of all OS tags used.

OS quantity framework

Max. number of OS single stations	8
Max. number of OS servers/pairs of servers	18
Max. number of automation systems per OS server/pair of servers	64
Max. number of OS clients in multi-client mode ¹⁾ per multiple station system	40
Max. number of monitors per operator station with multi-channel operation	4
Max. number of OS areas	64
Max. number of windows per monitor	1 to 16 (adjustable)
Number of trends per trend window	10
Selection time for OS area display (100 process symbols)	< 2 s
Max. number of configurable messages per server	200 000
Max. number of configurable process objects	Approx. 216 000
Max. number of configurable process tags	Approx. 128 000 ²⁾

Integral high-performance archive system

(cyclic buffer), based on Microsoft SQL server, for:

- Process value archiving (per OS server/single station) Approx. 1 500/s
- Message archiving (per OS server/single station) Steady-state load approx. 10/s
Message peak approx. 3 000 / 4 s

¹⁾ If every OS client has access to all OS servers/pairs of servers

²⁾ Approx. 300 000 I/O

Overview

The SIMATIC PCS 7 Industrial Workstation, the operating system, and the OS software are matched to one another in accordance with the application as OS single station, OS server or OS client.

Design

The OS standard software is already pre-configured for the corresponding OS Single Station, OS Server or OS Client as the target system, and pre-installed on it. You only need the corresponding software licenses in order to use it.

This basic level can be extended using additive software components and licenses.

You can equip OS Single Stations and OS Clients, for example, with SIMATIC PCS 7 SFC Visualization and SIMATIC S7 Safety Matrix Viewers.

Redundant system configurations are also possible with OS Single Stations and OS Servers. See "OS redundancy" in the "Operator System" section for details, [page 5/12](#)

The following tables provide a selection aid for ordering an operator station. Depending on whether a redundant or non-redundant design is selected, the tables indicate the respectively required number of

- SIMATIC PCS 7 Industrial Workstations
- Licenses for OS standard software
- Volume licenses (quantity options)
- Licenses for optional supplementary OS software

Single-user system

OS Single Station	Redundancy	
	without	with
with Windows 10 Enterprise 2019 LTSC operating system		
SIMATIC PCS 7 Industrial Workstation for ES/OS Single Station		
• With BCE communication for up to 8 automation systems (no redundancy stations)	1	2
• With Industrial Ethernet (IE) communication	1	2
Additional IE communication software for industrial workstations with IE communication		
SIMATIC NET HARDNET-IE S7-REDCONNECT PowerPack	1	2
OS standard software		
SIMATIC PCS 7 OS Software Single Station	1	–
SIMATIC PCS 7 Single Station Redundancy	–	1
Volume licenses and supplementary OS software (optional)		
SIMATIC PCS 7 OS Runtime License for adding OS Runtime POs	1	2
SIMATIC PCS 7 OS Archive for expansion of short-term cyclic buffer archive	1	2
SIMATIC PCS 7 SFC Visualization	1	2
SIMATIC S7 Safety Matrix Viewer	1	2

Multi-user system with client/server architecture

OS Server	Redundancy	
	without	with
with Windows Server 2019 Standard Edition operating system		
SIMATIC PCS 7 Industrial Workstation for OS Server		
• With BCE communication for up to 8 automation systems (no redundancy stations)	1	2
• With Industrial Ethernet communication	1	2
Additional IE communication software for industrial workstations with IE communication		
SIMATIC NET HARDNET-IE S7-REDCONNECT PowerPack	1	2
OS standard software		
SIMATIC PCS 7 OS Software Server	1	–
SIMATIC PCS 7 OS Software Server Redundancy	–	1
Volume licenses (optional)		
SIMATIC PCS 7 OS Runtime License for adding OS Runtime POs	1	2
SIMATIC PCS 7 OS Archive for expansion of short-term cyclic buffer archive	1	2
OS Client		
with Windows 10 Enterprise 2019 LTSC operating system; connection for terminal bus onboard		
SIMATIC PCS 7 Industrial Workstation for OS Client		
• SIMATIC PCS 7 Industrial Workstation for OS Client, with onboard standard graphics or with multi-monitor graphics card		1
• SIMATIC PCS 7 BOX OS Client 627D (without panel) or 677D (with panel)		1
• SIMATIC PCS 7 OS Client 427E/477E (Microbox)		1
OS standard software		
SIMATIC PCS 7 OS Software Client		1
Supplementary OS software (optional)		
SIMATIC PCS 7 SFC Visualization		1
SIMATIC S7 Safety Matrix Viewer		1
SIMATIC PCS 7 Logic Matrix Viewer (see "Engineering", "SIMATIC PCS 7 Logic Matrix" section)		1

Note on Microsoft SQL Server software

The "SQL Server" software from Microsoft which is delivered together with SIMATIC PCS 7 is exclusively intended for this process control system.

SIMATIC PCS 7 system software

Operator system
OS software

OS standard software for single station/server/client

Overview

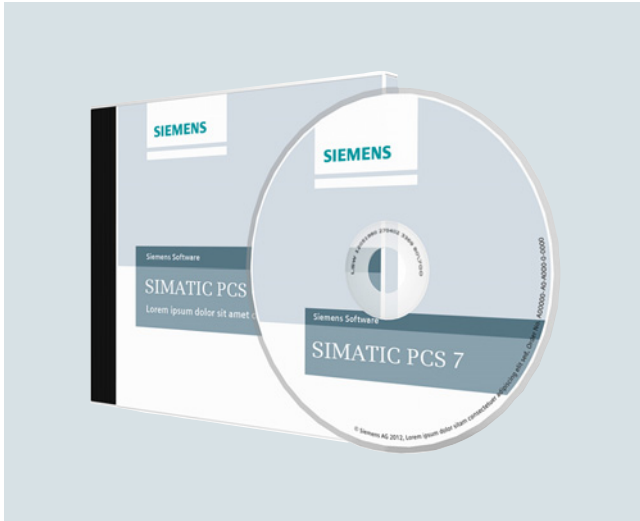

PCS 7 software incl. packaging

The OS standard software is adapted to the SIMATIC PCS 7 Industrial Workstations offered (OS Single Station, OS Server and OS Client).

It can be adapted to plants of various sizes by adding cumulative SIMATIC PCS 7 OS Runtime licenses for sets of 100, 1 000 und 5 000 process objects (PO). The expansion limits are

- 8 500 POs per OS Single Station
- 12 000 POs per OS Server

The high-performance circular buffer archiving system integrated in the OS standard software for OS Single Station and OS Server for temporary archiving can be expanded up to the maximum limit of 10 000 tags with cumulative SIMATIC PCS 7 OS volume licenses.

The OS standard software for a redundant pair of OS Servers or two redundant OS Single Stations is combined in a package (SIMATIC PCS 7 OS Software Server Redundancy or SIMATIC PCS 7 OS Software Single Station Redundancy). See section "OS redundancy" for details, [see page 5/12](#)

Subsequent conversion of the software license from OS Single Station to OS Server

It frequently happens in practice that systems based on OS Single Stations are later expanded to client-server configurations. The SIMATIC PCS 7 OS Software ConversionPack Single Station to Server allows you to subsequently convert the software license of your existing OS Single Station to an OS Server license.

Function

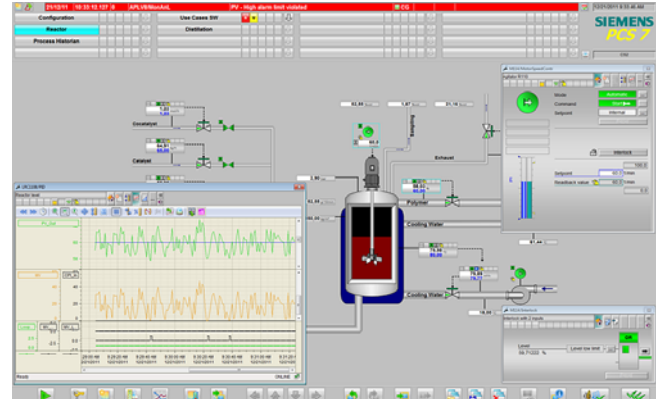

OS process control with freely-positionable windows

Graphical user interface (GUI)

The pre-defined user interface of the Operator System has all the features typical of a control system. It is multilingual, clearly structured, ergonomic and easy to understand. Operators can survey the process extremely easily, and rapidly navigate between different views of the plant. The system supports them in this process with hierarchical display structures that can be configured as required. These facilitate the direct selection of lower-level areas during process control. The current position within the hierarchy can always be recognized in a window of the Picture Tree Manager.

Process displays and process tags can also be called directly by their name, or by a "Loop-in-alarm" starting from a selected message. An online language selector permits the user to change the display language during runtime.

The project editor in the Operator System offers a wide range of different image formats and resolutions for showing process displays:

Graphic standard	Format	Resolution	Support of multi-monitor mode
XGA	4:3	1024 × 768	Yes
XGA+	4:3	1152 × 864	Yes
SXGA	5:4	1280 × 1024	Yes
UXGA	4:3	1600 × 1200	Yes
WSXGA+	16:10	1680 × 1050	Yes
HD 1080 (Full HD)	16:9	1920 × 1080	Yes
WUXGA	16:10	1920 × 1200	Yes
WQXGA	16:10	2560 × 1600	--

Their use depends on how the graphics controller of the operator station and the process monitors controlled by it are designed.

The representative functional display of the plant is supported by a high-quality, modern design. The global appearance can be set using pre-defined or user-specific designs: color palette, colors, styles (fill patterns), optical effects (2D/3D, shading, transparency, colored identification of an image object when selected, etc.). These can be changed locally for each image object.

The design is also defined using a wide range of attractive elements provided by the Graphics Designer during configuration in the engineering system.

Function (continued)

Process tag browser

The SIMATIC PCS 7 process tag browser enables status information from APL-based process tags to be displayed, filtered and sorted. Process tags that have a certain status can then be quickly identified and selected. The faceplate of a process tag can be selected directly in the process display via the Loop In function. The query results of the process tag browser can be saved and printed out.

TrendControls function for table displays and curve displays

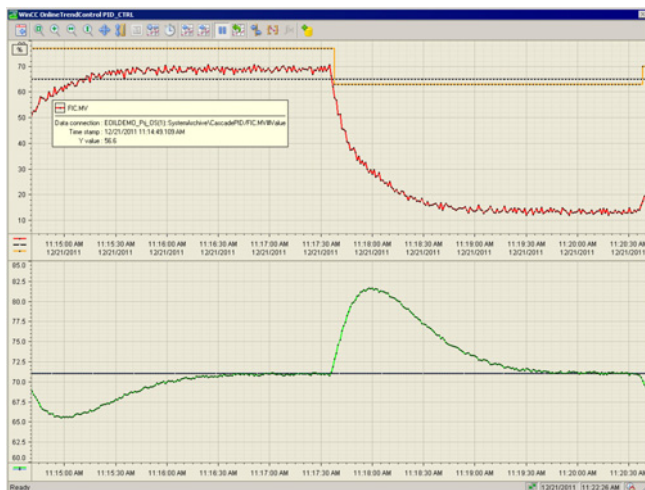

Trend window on the operator station

With TrendControls the operator can display archived values:

- Archive tags from the process value archive
- Online values of process tags from tag management

The display is in relation to time (table/trend window) or in relation to another value (function window).

The time can be defined statically (absolute, as configured) or dynamically (in relation to the actual system time) as:

- Start and end times
- Start time and period
- Start time and number of measuring points

All TrendControls have scrolling functions and a function for directly selecting the start or end.

During runtime, operators can individually adapt the TrendControls functions which have already been pre-defined during plant configuration, and save the settings globally or user-specific. They are able to change the data link during runtime, and to access other data. It is also possible to integrate exported archive databases online.

APL Operator Trend Control

The APL Operator Trend Control coordinated with the Advanced Process Library offers another option to the operator for flexible online compilation of trends. The values for the trend display are selected with a simple mouse click, in which case the value range and unit are adopted automatically by the process tag. The selection made can be subsequently adjusted by adding and removing values. In addition, messages corresponding to the trend selection can be called.

AlarmControl function for message display and processing

Up to 200 000 messages can be configured per OS Single Station/OS Server:

- Pre-defined system messages, triggered by a system event
- Individual or group messages, initiated by a change in process states
- Operator input messages, resulting from the manual operation of objects

The message system integrated in the Operator System records these process messages and local events, saves them in message archives, and displays them using message lists.

Flexible setting options for audio output support message signaling with a sound card or by controlling external horns via a signal module.

The "Loop-in-alarm" and "Select display using process tag" functions support the quick evaluation and resolution of faults. Using "Loop-in-alarm", the operator can jump directly from a message selected in the message window to the process display with the object which caused the fault, and can then call up the associated faceplate (loop display) through the process tag whose block icon is colored (cyan). The faceplate window (loop display) can be anchored so that it remains visible even when the display is changed.

Group displays visually signal the messages currently present in the process display. They also provide information on whether messages are disabled or not.

Time	Event	Severity	Total duration
11:15:00 AM	High pressure alarm	High	00:00:00
11:15:30 AM	Temperature alarm	High	00:00:00
11:16:00 AM	Flow rate alarm	High	00:00:00
11:16:30 AM	Pressure alarm	High	00:00:00
11:17:00 AM	Temperature alarm	High	00:00:00
11:17:30 AM	Flow rate alarm	High	00:00:00
11:18:00 AM	Pressure alarm	High	00:00:00
11:18:30 AM	Temperature alarm	High	00:00:00
11:19:00 AM	Flow rate alarm	High	00:00:00
11:19:30 AM	Pressure alarm	High	00:00:00
11:20:00 AM	Temperature alarm	High	00:00:00
11:20:30 AM	Flow rate alarm	High	00:00:00
11:21:00 AM	Pressure alarm	High	00:00:00
11:21:30 AM	Temperature alarm	High	00:00:00
11:22:00 AM	Flow rate alarm	High	00:00:00

Operator station message list

Reporting and logging system

The project created during configuration is documented with the reporting system. The logging system allows an easy-to-read printout of data acquired during operation. Different types of pre-defined logs are available:

- Message sequence log
- Message and archive log
- Measured value log
- Operator activity log
- System message log
- User log

SIMATIC PCS 7 system software

Operator system

OS software

OS standard software for single station/server/client

Function (continued)

However, a page layout editor can be used to create completely new page layouts or to individually adapt pre-defined ones. Log objects to be printed are simply selected from the editor's object palette, positioned and configured.

Data archiving

The high-performance archiving system, configurable at runtime, in the OS standard software of OS Single Stations and OS Servers temporarily records process values and messages/events (alarms) in cyclic archives. Intervals of approximately 1 to 4 weeks for process values and approximately 2 months for alarms are typical for this short-term archiving. Data from the cyclic archives can be exported time-controlled or event-controlled to the Process Historian for permanent archiving. See the "Process data archiving and reporting" section for information on this.

Central user administration, access control and electronic signature

With SIMATIC Logon, the Operator System has central user administration with access control that complies with the validation requirements of 21 CFR Part 11. The administrator can divide the users into groups and assign differently defined access rights (roles) to these groups. The operator obtains the specific rights when logging on within the scope of the access control. Apart from the keyboard, an optional smart card reader, for example, can be used as the logon device. In addition, SIMATIC Logon offers the "electronic signature" function.

SIMATIC Logon is fully integrated in SIMATIC PCS 7. In the context of SIMATIC PCS 7, no software licenses need be ordered for this. For more information on SIMATIC Logon as well as ordering data for an optional smart card reader, see "Expansion components, smart card reader" in the "Process Control System IPC" section, [see page 12/27](#).

Ordering data	Article No.	Article No.
<p>OS Software single station</p> <p>Runs with the following operating systems (see SIMATIC PCS 7 Readme for the latest information¹⁾):</p> <ul style="list-style-type: none"> Windows 10 Enterprise 2019 LTSC 		
<p>SIMATIC PCS 7 OS Software single station V9.1 incl. 100 OS Runtime PO</p> <p>5 languages (English, German, French, Italian, Spanish), software class A, single license for 1 installation</p> <p>With SIMATIC PCS 7 Software Media Package</p> <ul style="list-style-type: none"> Goods delivery License key on USB flash drive, Certificate of License, bundled with 1 × SIMATIC PCS 7 Software Media Package per order item Online delivery License key download and online Certificate of License, combined with SIMATIC PCS 7 Software Media Package (software download and online Certificate of License) Note: Email address required! 	<p>6ES7658-2AA68-0YA0</p> <p>6ES7658-2AA68-0YH0</p>	<p>SIMATIC PCS 7 OS Software Server ASIA V9.1 incl. 100 OS Runtime PO</p> <p>2 languages (English, Chinese), software class A, single license for 1 installation</p> <p>With SIMATIC PCS 7 Software Media Package ASIA</p> <p>Goods delivery ASIA license key on USB hardlock and Certificate of License, bundled with 1 × SIMATIC PCS 7 Software Media Package ASIA per order item</p> <ul style="list-style-type: none"> ASIA SN ASIA (including SOFTNET REDCONNECT) <p>6ES7658-2BA68-0CA0</p> <p>6ES7658-2BA68-6CA0</p>
<p>SIMATIC PCS 7 OS Software single station ASIA V9.1 incl. 100 OS Runtime PO</p> <p>2 languages (English, Chinese), software class A, single license for 1 installation</p> <p>With SIMATIC PCS 7 Software Media Package ASIA</p> <p>Goods delivery ASIA license key on USB hardlock and Certificate of License, bundled with 1 × SIMATIC PCS 7 Software Media Package ASIA per order item</p> <ul style="list-style-type: none"> ASIA SN ASIA (including SOFTNET REDCONNECT) 	<p>6ES7658-2AA68-0CA0</p> <p>6ES7658-2AA68-6CA0</p>	<p>Volume licenses (quantity options)</p> <p><u>Runtime licenses for PO expansion for OS Software single station/OS Software server</u></p> <p>SIMATIC PCS 7 OS Runtime License</p> <p>For extending the OS Runtime POs, cumulative</p> <p>Language-neutral, software class A, single license for 1 installation</p> <p>Without SIMATIC PCS 7 Software Media Package</p> <ul style="list-style-type: none"> Goods delivery License key on USB flash drive and Certificate of License <ul style="list-style-type: none"> - 100 POs - 1 000 POs - 5 000 POs Online delivery License key download and online Certificate of License Note: Email address required! <ul style="list-style-type: none"> - 100 POs - 1 000 POs - 5 000 POs <p>6ES7658-2XA00-0XB0</p> <p>6ES7658-2XB00-0XB0</p> <p>6ES7658-2XC00-0XB0</p> <p>6ES7658-2XA00-0XH0</p> <p>6ES7658-2XB00-0XH0</p> <p>6ES7658-2XC00-0XH0</p>
<p>OS Software Server</p> <p>Runs with the following operating systems (see SIMATIC PCS 7 Readme for the latest information¹⁾):</p> <ul style="list-style-type: none"> Windows Server 2019 Standard Edition 		<p><u>Expansion of integrated high-performance circular buffer archive (512 tags) of OS single station and OS server</u></p>
<p>SIMATIC PCS 7 OS Software Server V9.1 incl. 100 OS Runtime PO</p> <p>5 languages (English, German, French, Italian, Spanish), software class A, single license for 1 installation</p> <p>With SIMATIC PCS 7 Software Media Package</p> <ul style="list-style-type: none"> Goods delivery License key on USB flash drive, Certificate of License, bundled with 1 × SIMATIC PCS 7 Software Media Package per order item Online delivery License key download and online Certificate of License, combined with SIMATIC PCS 7 Software Media Package (software download and online Certificate of License) Note: Email address required! 	<p>6ES7658-2BA68-0YA0</p> <p>6ES7658-2BA68-0YH0</p>	<p>SIMATIC PCS 7 OS Archive</p> <p>Cumulative archive licenses, independent of language, software class A, single license for 1 installation</p> <p>Without SIMATIC PCS 7 Software Media Package</p> <ul style="list-style-type: none"> Goods delivery License key on USB flash drive and Certificate of License <ul style="list-style-type: none"> - 1 500 tags - 5 000 tags - 10 000 tags - 30 000 tags Online delivery License key download and online Certificate of License Note: Email address required! <ul style="list-style-type: none"> - 1 500 tags - 5 000 tags - 10 000 tags - 30 000 tags <p>6ES7658-2EA00-2YB0</p> <p>6ES7658-2EB00-2YB0</p> <p>6ES7658-2EC00-2YB0</p> <p>6ES7658-2ED00-2YB0</p> <p>6ES7658-2EA00-2YH0</p> <p>6ES7658-2EB00-2YH0</p> <p>6ES7658-2EC00-2YH0</p> <p>6ES7658-2ED00-2YH0</p>

SIMATIC PCS 7 system softwareOperator system
OS software**OS standard software for single station/server/client****Ordering data****Article No.****OS Software Client**

Runs with the following operating systems (see SIMATIC PCS 7 Readme for the latest information¹⁾):

- Windows 10 Enterprise 2019 LTSC

SIMATIC PCS 7 OS Software Client V9.1

5 languages (English, German, French, Italian, Spanish), software class A, floating license for 1 user
Without SIMATIC PCS 7 Software Media Package

- Goods delivery
License key on USB flash drive and Certificate of License
- Online delivery
License key download and online Certificate of License
Note: Email address required!

6ES7658-2CX68-0YB5**6ES7658-2CX68-0YH5****SIMATIC PCS 7 OS Software Client ASIA V9.1**

2 languages (English, Chinese), software class A, floating license for 1 user

Without SIMATIC PCS 7 Software Media Package ASIA

- Goods delivery
ASIA license key on USB hardlock and Certificate of License

6ES7658-2CX68-0CB5**Conversion of the software license from OS single station to OS server**

Runs with the following operating systems (see SIMATIC PCS 7 Readme for the latest information¹⁾):

- Windows Server 2019 Standard Edition

SIMATIC PCS 7 OS Software ConversionPack single station to server V9.1

For conversion of an operator station from OS single station to OS server

Supports all languages of the OS Software single station, software class A, single license for 1 installation

Without SIMATIC PCS 7 Software Media Package

- Goods delivery
License key on USB flash drive and Certificate of License
- Online delivery
License key download and online Certificate of License
Note: Email address required!

6ES7658-2BA68-0YD0**6ES7658-2BA68-0YJ0**

¹⁾ See "Software Media and Logistics" section, under "System documentation", see page 1/7

For more information on the Software Media Package, see section "Software Media and Logistics", under "Software Packages", see page 1/2

More information**Regional product versions**

All SIMATIC PCS 7 software products are designed for international use, in other words there is only one product version for worldwide use and this is offered in up to 5 languages: English, German, French, Italian and Spanish. However, the number of supported languages is not standard; it can vary from product to product.

In addition, a regional "ASIA" product version will also be offered for the SIMATIC PCS 7 Software Media Package and specific SIMATIC PCS 7 software products of the "Engineering System" and "Operator System" system components. The ASIA products are available in two languages: English and Chinese (simplified). They are explicitly identified in the name by the suffix "ASIA".

If a product listed in this catalog does not have the suffix "ASIA" in its name, it can always be used globally. However, the following restriction applies: If a regional ASIA product is offered, the pendant for international use does not support the Asian languages (currently Chinese simplified) present in the ASIA product.

The products for international use, i.e. products without the suffix "ASIA", are not intended as the basis for runtime systems with fonts in Asian languages.

The following special points must be observed as a result of the definition of separate products for installation software and licenses. The SIMATIC PCS 7 installation software is available in the form of two data medium packages:

- SIMATIC PCS 7 Software Media Package
- SIMATIC PCS 7 Software Media Package ASIA

The specific ASIA software licenses harmonize exclusively with the SIMATIC PCS 7 Software Media Package ASIA. SIMATIC PCS 7 software licenses for which there is no ASIA pendant can be used with both SIMATIC PCS 7 Software Media Packages.

Overview

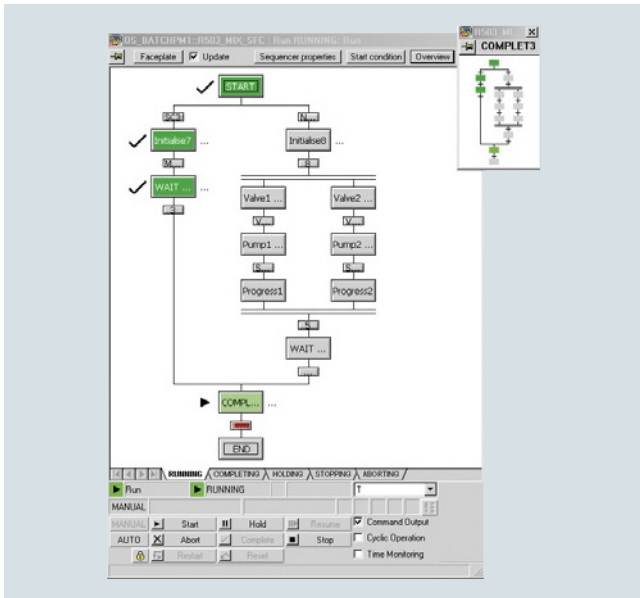

The OS standard software can be expanded with the SIMATIC PCS 7 SFC Visualization. This allows you to display and operate configured sequential controls on the engineering system.

In an overview display it is possible, for example, to open step and transition displays and to present step comments or dynamically supplied step enabling conditions.

Ordering data

Article No.

SIMATIC PCS 7 SFC Visualization V9.1

For displaying and operating SFC sequence controls on an operator station

6 languages (English, German, French, Italian, Spanish, Chinese), software class A

Runs with the following operating systems (see SIMATIC PCS 7 Readme for the latest information¹⁾):

- Windows 10 Enterprise 2019 LTSC
- Windows Server 2019 Standard Edition

Floating license for 1 user, without SIMATIC PCS 7 Software Media Package

- Goods delivery
License key on USB flash drive and Certificate of License
- Online delivery
License key download and online Certificate of License
Note: Email address required!

6ES7652-0XD68-2YB5

6ES7652-0XD68-2YH5

¹⁾ See "Software Media and Logistics" section, under "System documentation", see page 1/7

SIMATIC PCS 7 system software

Operator system

OS redundancy

Overview

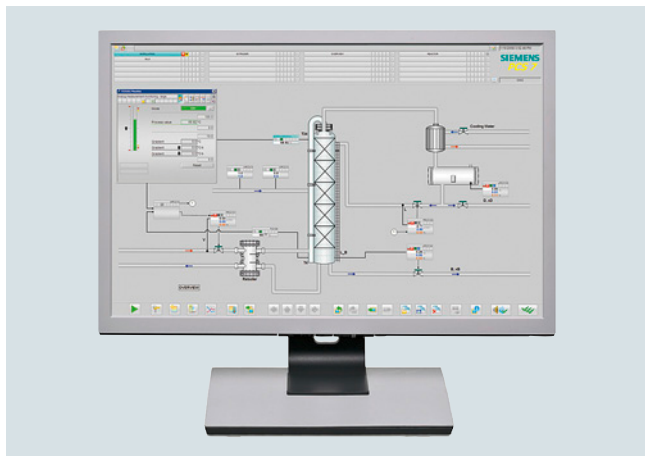

SIMATIC PCS 7 Operator Station

OS single stations and OS servers can have a redundant design if necessary. The following program packages are available:

- SIMATIC PCS 7 Single Station Redundancy for setup of redundant OS Single Stations
- SIMATIC PCS 7 Server Redundancy for setup of redundant OS servers.

For optimizing internal communication, connect the two stations of the redundant OS Single Station/OS Server pair to each other either via an RS 232 connecting cable or via an Ethernet cable, e.g. cross-over network cable with RJ45 connectors (up to 100 m). The cable material is to be ordered separately in each case:

Depending on the environmental conditions and the distance involved, the Ethernet connection between the two redundant stations can be implemented either as an electrical or optical connection. For more information, refer to the "SIMATIC PCS 7 High-availability Process Control Systems" manual; for suitable cable material and further accessories, refer to Catalog IK PI (Industrial Communication).

What further components are required depends on the plant architecture. The design of the plant bus and terminal bus is of particular importance, as well as the type and number of subordinate automation systems. The maximum requirements are determined by the redundant configuration shown in the figure with a fault-tolerant automation system and two redundant rings each for the plant bus and terminal bus.

Design

The following table provides an overview of which components are required for a redundant OS Single Station or OS pair of servers depending on certain criteria:

Hardware and software components	Up to 8 AS per Single Station or server pair	9 to 64 AS per Single Station or server pair	Min. 1 redundant AS
SIMATIC PCS 7 Industrial Workstation, ES/OS Single Station or OS Server version			
• Incl. Ethernet network adapter 10/100/1 000 Mbps and BCE communication	2	–	–
• incl. CP 1623 and SIMATIC NET HARDNET-IE S7	2 (alternative to BCE)	2	2
Software			
SIMATIC PCS 7 Single Station/Server Redundancy	1	1	1
SIMATIC NET HARDNET-IE S7-REDCONNECT PowerPack	–	–	2
Connection to redundant plant bus (2 rings)			
• BCE Desktop adapter network adapter	2	–	–
• CP 1623 Communication module	2 (alternative to BCE)	2	2
SIMATIC NET HARDNET-IE S7	2 (alternative to BCE)	2	2
SIMATIC NET HARDNET-IE S7 REDCONNECT	–	–	2
Connection to redundant terminal bus with PRP (2 rings)			
SOFTNET-IE RNA communication software	1 × per PCS 7 station on the terminal bus	1 × per PCS 7 station on the terminal bus	1 × per PCS 7 station on the terminal bus
Integration of non-PRP-enabled devices in redundant terminal bus with PRP			
SCALANCE X204RNA	1 × for 2 terminal devices	1 × for 2 terminal devices	1 × for 2 terminal devices

Overview (continued)

Connection to plant bus

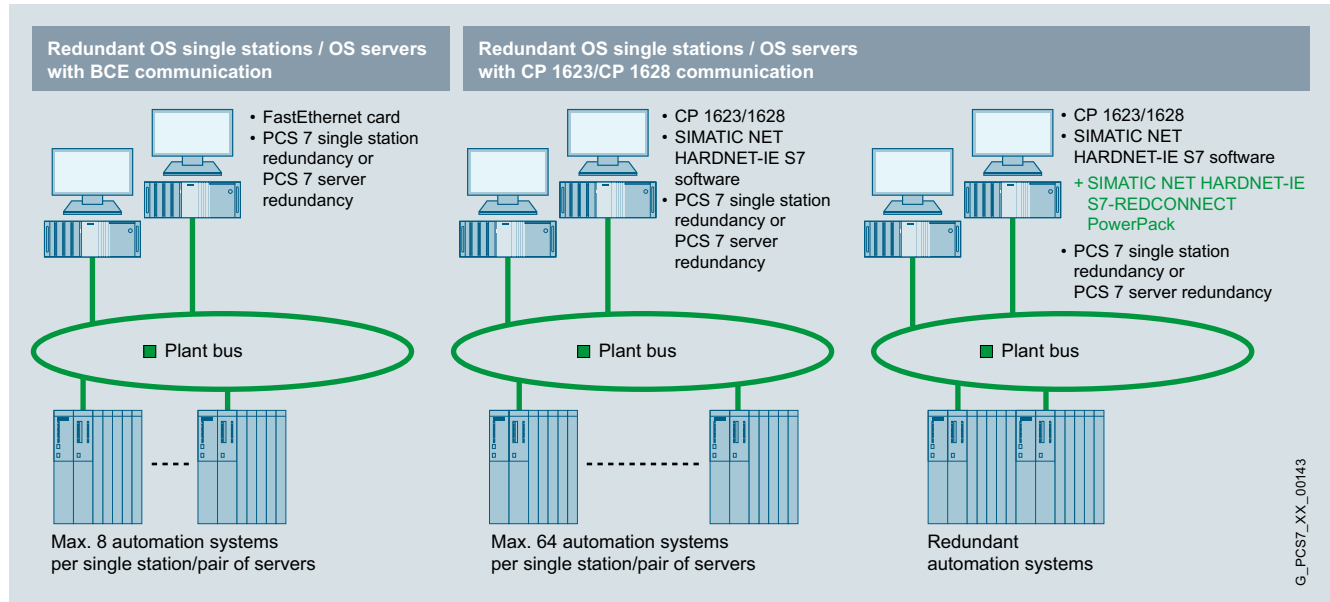

Components for connection of redundant OS Single Stations / OS Servers on the plant bus

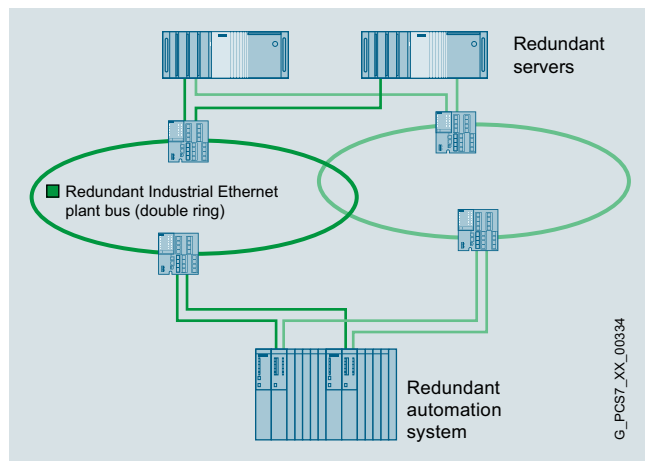

Redundant plant bus

The Operator Systems (Single Stations or Servers) communicate with the automation systems via the Industrial Ethernet plant bus. The following special points must be observed for redundant configurations:

- BCE communication with the 10/100/1 000 Mbps Ethernet card is basically sufficient even for redundant operator stations. This allows the connection of up to 8 automation systems per server pair (AS Single Stations only, not AS Redundancy Stations). The BCE license is included for the BCE versions of the SIMATIC PCS 7 Industrial Workstation. It is also valid for an additional desktop adapter network adapter.
- Industrial Ethernet communication via CP 1623 (pre-installed in the IE version of the SIMATIC PCS 7 Industrial Workstation) is required in the following cases:
 - The number of automation systems per OS is larger than 8.
 - Redundant automation systems (AS Redundancy Stations) are used.

- The IE versions of the SIMATIC PCS 7 Industrial Workstation are equipped with a CP 1623 and SIMATIC NET HARDNET-IE S7 communication software, licensed for up to four CP 1623 (4x license). If lower-level AS Redundancy Stations are to be connected, however, SIMATIC NET HARDNET-IE S7-REDCONNECT is required. The SIMATIC NET product HARDNET-IE S7REDCONNECT PowerPack (license for 4 units) can be used to upgrade features.
- If an operator station with BCE communication is to be upgraded for operation with AS Redundancy Stations, a CP 1623 communications module is required in addition to the SIMATIC NET HARDNET-IE S7-REDCONNECT (4x license).
- If the plant bus is to be designed as a redundant dual ring, you require two interface modules (2 x Ethernet network adapters 10/100/1 000 Mbps or 2 x CP 1623) per OS Single Station or OS Server.

The communication software for CP 1623 is always supplied with the SIMATIC PCS 7 software and is installed in line with the operating system.

In order to activate this communication software, you may need additional licenses for the

- SIMATIC NET HARDNET-IE S7,
- SIMATIC NET HARDNET-IE S7-REDCONNECT or
- SIMATIC NET HARDNET-IE S7 REDCONNECT PowerPack communication products.

SIMATIC PCS 7 system software

Operator system

OS redundancy

Design (continued)

Connection to terminal bus

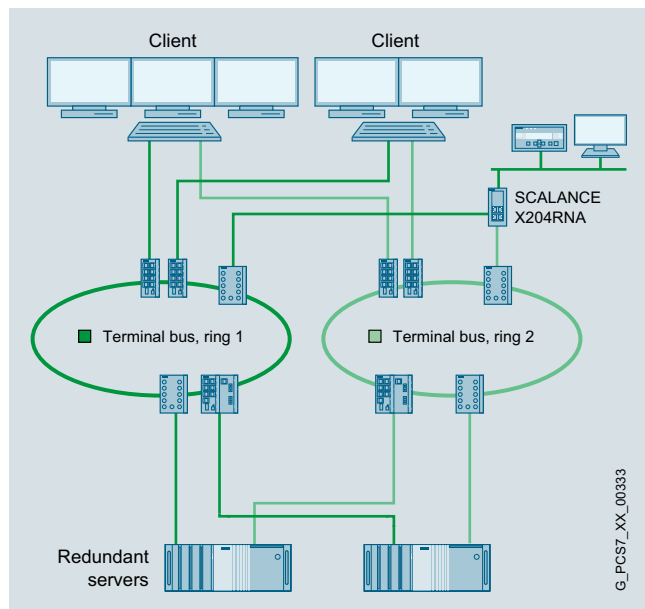

Redundant terminal bus

You can connect clients and servers to the terminal bus using integrated Industrial Ethernet interface modules or a desktop network adapter card.

A configuration with two separate rings is recommended for the redundant, high-availability terminal bus. Communication is performed in this case using the Parallel Redundancy Protocol (PRP) in accordance with IEC 62439-3. Each PCS 7 station should be connected to one of two Industrial Ethernet interface modules on each of the two separate rings.

The SIMATIC NET SOFTNET-IE RNA communication software on the redundantly connected PCS 7 stations organizes communication processes based on the PRP. Therefore, SIMATIC NET SOFTNET-IE RNA communication software is required on each of the redundantly connected PCS 7 stations.

Connecting non-PRP-enabled devices

Non-PRP-enabled terminal devices, which only have an Industrial Ethernet connection, can be integrated into a redundant, high-availability terminal bus with PRP protocol using the required RUGGEDCOM RSG900 switches. Two product variants of the RUGGEDCOM RSG900 are available for this purpose:

- RUGGEDCOM RSG907R
Router in metal enclosure with 4x optical ports for connecting up to four non-PRP-enabled terminals and two optical/electrical combo ports for network connection to redundant networks
- RUGGEDCOM RSG909R
Router in metal enclosure with 6x electric terminal device ports and two optical/electrical combo ports for network connection of up to two non-PRP-enabled terminal devices to redundant networks

RUGGEDCOM RSG900 is typically installed with the stations to be connected in a control cabinet.

You can find more information and technical specifications for the two RUGGEDCOM product variants in Catalog IK PI.

For details on redundant SIMATIC PCS 7 configurations, refer to the manual "High Availability Process Control Systems".

Subsequent conversions

It is common practice to retroactively change or expand a plant. The following SIMATIC PCS 7 OS Software ConversionPacks support both retrofitting of the redundancy functionality, as well as the conversion from redundant OS Single Stations to redundant OS Servers:

- SIMATIC PCS 7 OS Software ConversionPack 2x Single Station to Single Station Redundancy for converting two OS Single Stations to OS Single Station Redundancy
- SIMATIC PCS 7 OS Software ConversionPack 2x Server to Server Redundancy for converting two OS Servers to OS Server Redundancy
- SIMATIC PCS 7 OS Software ConversionPack Single Station Redundancy to Server Redundancy for converting two redundant OS Single Stations from OS Single Station Redundancy to OS Server Redundancy

Ordering data	Article No.	Article No.
<p>Setup of redundant OS single stations</p> <p>SIMATIC PCS 7 OS Software single station redundancy V9.1, incl. 100 OS Runtime PO 5 languages (English, German, French, Italian, Spanish), software class A, runs with Windows 10 Enterprise 2019 LTSC (see SIMATIC PCS 7 Readme for the latest information¹⁾), single license for 2 installations</p> <p>With SIMATIC PCS 7 Software Media Package</p> <ul style="list-style-type: none"> • Goods delivery License key on USB flash drive, Certificate of License, bundled with 1 × SIMATIC PCS 7 Software Media Package per order item • Online delivery License key download and online Certificate of License, combined with SIMATIC PCS 7 Software Media Package (software download and online Certificate of License) Note: Email address required! 	<p>6ES7652-3AA68-2YA0</p> <p>6ES7652-3AA68-2YH0</p>	<p>SIMATIC PCS 7 OS Software Server Redundancy ASIA V9.1, incl. 100 OS Runtime PO 2 languages (English, Chinese), software class A, runs with Windows Server 2019 Standard Edition (see SIMATIC PCS 7 Readme¹⁾ for the latest information), single license for 2 installations</p> <p>With SIMATIC PCS 7 Software Media Package ASIA</p> <p>Goods delivery 2 × ASIA license key on USB hardlock and Certificate of License, bundled with 1 × SIMATIC PCS 7 Software Media Package ASIA per order item</p> <ul style="list-style-type: none"> • ASIA • SN ASIA (including SOFTNET REDCONNECT) <p>6ES7652-3BA68-2CA0 6ES7652-3BA68-6CA0</p>
<p>SIMATIC PCS 7 OS Software single station redundancy ASIA V9.1, incl. 100 OS Runtime PO 2 languages (English, Chinese), software class A, runs with Windows 10 Enterprise 2019 LTSC (see SIMATIC PCS 7 Readme¹⁾ for the latest information), single license for 2 installations</p> <p>Goods delivery 2 × ASIA license key on USB hardlock and Certificate of License, bundled with 1 × SIMATIC PCS 7 Software Media Package ASIA per order item</p> <ul style="list-style-type: none"> • ASIA • SN ASIA (including SOFTNET REDCONNECT) 	<p>6ES7652-3AA68-2CA0 6ES7652-3AA68-6CA0</p>	<p>SIMATIC PCS 7 OS Runtime License For extending the OS Runtime POs, cumulative</p> <p>Language-neutral, software class A, single license for 1 installation</p> <p>Without SIMATIC PCS 7 Software Media Package</p> <ul style="list-style-type: none"> • Goods delivery License key on USB flash drive and Certificate of License <ul style="list-style-type: none"> - 100 POs - 1 000 POs - 5 000 POs • Online delivery License key download and online Certificate of License Note: Email address required! <ul style="list-style-type: none"> - 100 POs - 1 000 POs - 5 000 POs <p>6ES7658-2XA00-0XB0 6ES7658-2XB00-0XB0 6ES7658-2XC00-0XB0</p>
<p>Design of redundant OS Servers</p> <p>SIMATIC PCS 7 OS Software Server Redundancy V9.1, incl. 100 OS Runtime PO 5 languages (English, German, French, Italian, Spanish), software class A, runs with Windows Server 2019 Standard Edition (see SIMATIC PCS 7 Readme for the latest information¹⁾), single license for 2 installations</p> <p>With SIMATIC PCS 7 Software Media Package</p> <ul style="list-style-type: none"> • Goods delivery License key on USB flash drive, Certificate of License, bundled with 1 × SIMATIC PCS 7 Software Media Package per order item • Online delivery License key download and online Certificate of License, combined with SIMATIC PCS 7 Software Media Package (software download and online Certificate of License) Note: Email address required! 	<p>6ES7652-3BA68-2YA0</p> <p>6ES7652-3BA68-2YH0</p>	<p>SIMATIC PCS 7 OS Archive Cumulative archive licenses, independent of language, software class A, single license for 1 installation</p> <p>Without SIMATIC PCS 7 Software Media Package</p> <ul style="list-style-type: none"> • Goods delivery License key on USB flash drive and Certificate of License <ul style="list-style-type: none"> - 1 500 tags - 5 000 tags - 10 000 tags - 30 000 tags • Online delivery License key download and online Certificate of License Note: Email address required! <ul style="list-style-type: none"> - 1 500 tags - 5 000 tags - 10 000 tags - 30 000 tags <p>6ES7658-2EA00-2YB0 6ES7658-2EB00-2YB0 6ES7658-2EC00-2YB0 6ES7658-2ED00-2YB0</p> <p>6ES7658-2EA00-2YH0 6ES7658-2EB00-2YH0 6ES7658-2EC00-2YH0 6ES7658-2ED00-2YH0</p>
<p>Expansion of integrated high-performance circular buffer archive (512 tags) of OS single station and OS server; 2 licenses required for each</p>		

SIMATIC PCS 7 system software

Operator system

OS redundancy

Ordering data

Article No.

Article No.

Conversion of two OS single stations to redundant OS single stations**SIMATIC PCS 7 OS Software ConversionPack 2x single station to single station redundancy V9.1**

For conversion of two OS single stations to OS single station redundancy

Supports all languages of the OS Software single station, software class A, runs with Windows 10 Enterprise 2019 LTSC (see SIMATIC PCS 7 Readme for the latest information¹⁾), single license for 2 installations

Without SIMATIC PCS 7 Software Media Package

- Goods delivery
License key on USB flash drive and Certificate of License
- Online delivery
License key download and online Certificate of License
Note: Email address required!

6ES7652-3AA68-2YD0

6ES7652-3AA68-2YJ0

Conversion of two redundant OS single stations to redundant OS servers**SIMATIC PCS 7 OS Software ConversionPack single station redundancy to server redundancy V9.1**

For the conversion of two redundant OS single stations from OS single station redundancy to OS server redundancy

Supports all languages of the OS Software single station redundancy, software class A, runs with Windows Server 2019 Standard Edition (see SIMATIC PCS 7 Readme for the latest information¹⁾), single license for 2 installations

Without SIMATIC PCS 7 Software Media Package

- Goods delivery
License key on USB flash drive and Certificate of License
- Online delivery
License key download and online Certificate of License
Note: Email address required!

6ES7652-3BA68-2YC0

6ES7652-3BA68-1YJ0

Conversion of two OS Servers to redundant OS Servers**SIMATIC PCS 7 OS Software ConversionPack 2x Server to Server Redundancy V9.1**

For the conversion of two OS Servers to OS Server Redundancy

Supports all languages of the OS Software Server, software class A, runs with Windows Server 2019 Standard Edition (see SIMATIC PCS 7 Readme for the latest information¹⁾), single license for 2 installations

Without SIMATIC PCS 7 Software Media Package

- Goods delivery
License key on USB flash drive and Certificate of License
- Online delivery
License key download and online Certificate of License
Note: Email address required!

6ES7652-3BA68-2YD0

6ES7652-3BA68-2YJ0

Individual components

RS 232 connecting cable, 10 m
For redundant OS single stations / OS servers

6ES7902-1AC00-0AA0

Add-on components for OS single stations and OS servers

For connection to redundant plant bus (BCE or CP 1623/1628), for upgrading from BCE to CP 1623/1628 including communication with redundant AS

Desktop adapter network card
for BCE and as spare part for redundant terminal bus

A5E02639550

INTEL PCI network card for connection to Industrial Ethernet (10/100/1 000 Mbps), with RJ45 connection and PCI express interface

Note: License for the BCE communication with SIMATIC PCS 7 Industrial Workstations with BCE communication already included

CP 1623

PCI Express x1 card for connection to Industrial Ethernet (10/100/1 000 Mbps), with 2-port switch (RJ45)

6GK1162-3AA00

Licenses may be required for activating the functionality of the CP 1623

(Communication software is part of the SIMATIC PCS 7 software)

Activation license if no redundant AS are used

SIMATIC NET HARDNET-IE S7 V16

Runtime software, 2 languages (German/English), software class A

License for up to 4 Industrial Ethernet CPs, floating license for 1 user

Without SIMATIC PCS 7 Software Media Package

- Goods delivery
Software and electronic manual on DVD, license key USB flash drive
- Online delivery
Software, manual and license key download
Note: Email address required!

6GK1716-1CB16-0AA0

6GK1716-1CB16-0AK0

Activation licenses when using redundant AS

Alternative license for SIMATIC NET HARDNET-IE S7:

SIMATIC NET HARDNET-IE S7-REDCONNECT V16

Runtime software, 2 languages (English, German), software class A

License for up to 4 Industrial Ethernet CPs, floating license for 1 user

Without SIMATIC PCS 7 Software Media Package

- Goods delivery
Software and electronic manual on DVD, license key USB flash drive
- Online delivery
Software, manual and license key download
Note: Email address required!

6GK1716-0HB16-0AA0

6GK1716-0HB16-0AK0

Ordering data	Article No.
Additive license for SIMATIC NET HARDNET-IE S7:	
SIMATIC NET HARDNET-IE S7-REDCONNECT PowerPack V16 Runtime software, 2 languages (English, German), software class A License for up to 4 Industrial Ethernet CPs, floating license for 1 user Without SIMATIC PCS 7 Software Media Package	
• Goods delivery License key USB flash drive	6GK1716-0HB16-0AC0
• Online delivery License key download <u>Note:</u> Email address required!	6GK1716-0HB16-0AK1
Components for connecting SIMATIC PCS 7 stations to a redundant terminal bus with PRP protocol	
SOFTNET-IE RNA V16 Software for connecting SIMATIC PCS 7 stations to PRP-enabled networks with integrated SNMP Runtime software, 2 languages (English, German), software class A, runs with Windows 10 Enterprise 2019 LTSC Windows Server 2019 Standard Edition Floating license for 1 user Without SIMATIC PCS 7 Software Media Package Goods delivery Software and electronic manual on DVD, license key USB flash drive	6GK1711-1EW16-0AA0
Industrial Ethernet routers RUGGEDCOM RSG900	
• RUGGEDCOM RSG907R Industrial hardened fully-managed Ethernet switch with 7 ports and integrated HSR/PRP RedBox for use in harsh industrial environments. The product has 3x 1 Gbps SFP slots and 4x 100 Mbps multimode LC ports (max. 2 km). Operating temperature from -40 to +85 °C (without fan).	6GK6490-7RB..-....
• RUGGEDCOM RSG909R Industrial hardened fully-managed Ethernet switch with 9 ports and integrated HSR/PRP RedBox for use in harsh industrial environments. The product has 3x 1 Gbps SFP slots and 6x 10/100/1 000 Mbps RJ45 Ethernet ports. Operating temperature from -40 to +85 °C (without fan).	6GK6498-0RB..-....
Accessories such as cable material, connection plugs and transceivers	See section Communication, Industrial Ethernet, System Connection PCS 7 Systems

1) See "Software Media and Logistics" section, under "System documentation", see page 1/7

You can find more information on the Software Media Package in the section "Software Media and Logistics", subsection "PCS 7 Software Packages".

More information

Regional product versions

All SIMATIC PCS 7 software products are designed for international use, in other words there is only one product version for worldwide use and this is offered in up to 5 languages: English, German, French, Italian and Spanish. However, the number of supported languages is not standard; it can vary from product to product.

In addition, a regional "ASIA" product version will also be offered for the SIMATIC PCS 7 Software Media Package and specific SIMATIC PCS 7 software products of the "Engineering System" and "Operator System" system components. The ASIA products are available in two languages: English and Chinese (simplified). They are explicitly identified in the name by the suffix "ASIA".

If a product listed in this catalog does not have the suffix "ASIA" in its name, it can always be used globally. However, the following restriction applies: If a regional ASIA product is offered, the pendant for international use does not support the Asian languages (currently Chinese simplified) present in the ASIA product.

The products for international use, i.e. products without the suffix "ASIA", are not intended as the basis for runtime systems with fonts in Asian languages.

The following special points must be observed as a result of the definition of separate products for installation software and licenses. The SIMATIC PCS 7 installation software is available in the form of two data medium packages:

- SIMATIC PCS 7 Software Media Package
- SIMATIC PCS 7 Software Media Package ASIA

The specific ASIA software licenses harmonize exclusively with the SIMATIC PCS 7 Software Media Package ASIA. SIMATIC PCS 7 software licenses for which there is no ASIA pendant can be used with both SIMATIC PCS 7 Software Media Packages.

SIMATIC PCS 7 system software

Operator system

Operator control and monitoring via Web

SIMATIC PCS 7 Web Server

Overview

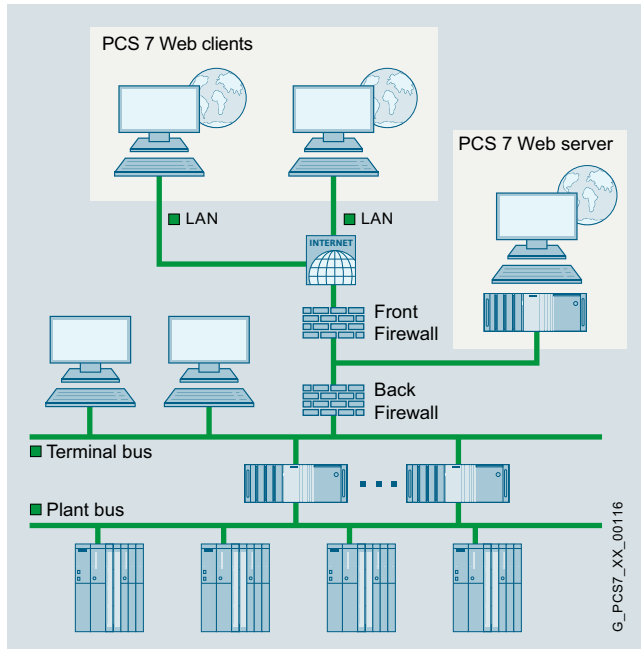

The PCS 7 Web server makes available the project data of the OS servers for PCS 7 Web clients and thus enables worldwide operator control and monitoring of a plant via intranet/Internet.

It does this by accessing project-specific process data in the lower-level OS servers using the mechanisms of a multi-client. The integrated OS user management guarantees a high degree of security here.

Application

A differentiation is basically made between the following types of application when operating and monitoring SIMATIC PCS 7 systems via the Web:

- Standard:
Up to 100 PCS 7 Web clients access the data of **one** PCS 7 Web server over the intranet/Internet.
- Diagnostics:
One or only a few Web clients have access to **several** PCS 7 Web servers/single-user systems for remote operation, diagnostics or monitoring.

Function



A plant can be operated and monitored via PCS 7 Web clients in the same manner as via the OS clients.

The process pictures are displayed on the PCS 7 Web clients with Internet Explorer. The PCS 7 Web clients access the project data provided by the PCS 7 Web server via an intranet or the Internet.

Ordering data	Article No.	Article No.	
"Standard" application			
SIMATIC PCS 7 Web Server Basic V9.1 6 languages (English, German, French, Italian, Spanish, Chinese), software class A, runs with Windows Server 2019 Standard Edition (see SIMATIC PCS 7 Readme for the latest information ¹⁾), single license for 1 installation Without SIMATIC PCS 7 Software Media Package <ul style="list-style-type: none"> • Goods delivery License key on USB flash drive, Certificate of License • Online delivery License key download, online Certificate of License <u>Note:</u> Email address required! 	6ES7658-2GX68-2YB0 6ES7658-2GX68-2YH0	SIMATIC PCS 7 Web Diagnose Client V9.1 6 languages (English, German, French, Italian, Spanish, Chinese), software class A, runs with Windows 10 Enterprise 2019 LTSC, (see SIMATIC PCS 7 Readme ¹⁾ for the latest information), single license for 1 installation Without SIMATIC PCS 7 Software Media Package <ul style="list-style-type: none"> • Goods delivery License key on USB flash drive, Certificate of License • Online delivery License key download, online Certificate of License <u>Note:</u> Email address required! 	6ES7658-2JX68-2YB0 6ES7658-2JX68-2YH0
"Diagnostics" application			
SIMATIC PCS 7 Web Server license (cumulative) Language-neutral, software class A, single license for 1 installation Without SIMATIC PCS 7 Software Media Package <ul style="list-style-type: none"> • Goods delivery License key on USB flash drive, Certificate of License <ul style="list-style-type: none"> - 1 client - 5 clients - 10 clients • Online delivery License key download, online Certificate of License <u>Note:</u> Email address required! <ul style="list-style-type: none"> - 1 client - 5 clients - 10 clients 	6ES7658-2GE00-0XB0 6ES7658-2GF00-0XB0 6ES7658-2GG00-0XB0 6ES7658-2GE00-0XH0 6ES7658-2GF00-0XH0 6ES7658-2GG00-0XH0	Additional OS Software Client license for the "Standard" and "Diagnostics" applications (required on the PCS 7 Web Server in addition to SIMATIC PCS 7 Web Server license or SIMATIC PCS 7 Web Diagnostics Server license)	
		SIMATIC PCS 7 OS Software Client V9.1²⁾ 5 languages (English, German, French, Italian, Spanish), software class A, runs with Windows 10 Enterprise 2019 LTSC (see SIMATIC PCS 7 Readme for the latest information ¹⁾), floating license for 1 user Without SIMATIC PCS 7 Software Media Package <ul style="list-style-type: none"> • Goods delivery License key on USB flash drive, Certificate of License • Online delivery License key download, online Certificate of License <u>Note:</u> Email address required! 	6ES7658-2CX68-0YB5 6ES7658-2CX68-0YH5
		SIMATIC PCS 7 OS Software Client ASIA V9.1¹⁾ 2 languages (English, Chinese), software class A, runs with Windows 10 Enterprise 2019 LTSC (see SIMATIC PCS 7 Readme ¹⁾ for the latest information), floating license for 1 user Without SIMATIC PCS 7 Software Media Package ASIA <ul style="list-style-type: none"> • Goods delivery ASIA license key on USB hardlock, Certificate of License 	6ES7658-2CX68-0CB5
SIMATIC PCS 7 Web Diagnose Server V9.1 6 languages (English, German, French, Italian, Spanish, Chinese), software class A, runs with Windows Server 2019 Standard Edition (see SIMATIC PCS 7 Readme for the latest information ¹⁾), single license for 1 installation Without SIMATIC PCS 7 Software Media Package <ul style="list-style-type: none"> • Goods delivery License key on USB flash drive, Certificate of License • Online delivery License key download, online Certificate of License <u>Note:</u> Email address required! 	6ES7658-2HX68-2YB0 6ES7658-2HX68-2YH0		

¹⁾ See "Software Media and Logistics" section, under "System documentation", see page 1/7

²⁾ Deviating from the specification in the ordering data, the license of the OS Software Client in these special applications is also enabled for the server operating system Windows Server 2019 Standard Edition.

More information

To ensure safe operation of the plant, you need to take suitable protective measures that also include IT security (e.g. network segmentation). For more information on the topic of Industrial Security, go to: <http://www.siemens.com/industrialsecurity>

SIMATIC PCS 7 system software

Notes

5

Process data archiving and reporting



6/2	Introduction
6/3	Process Historian and Information Server

SIMATIC PCS 7 system software

Process data archiving and reporting

Introduction

Overview

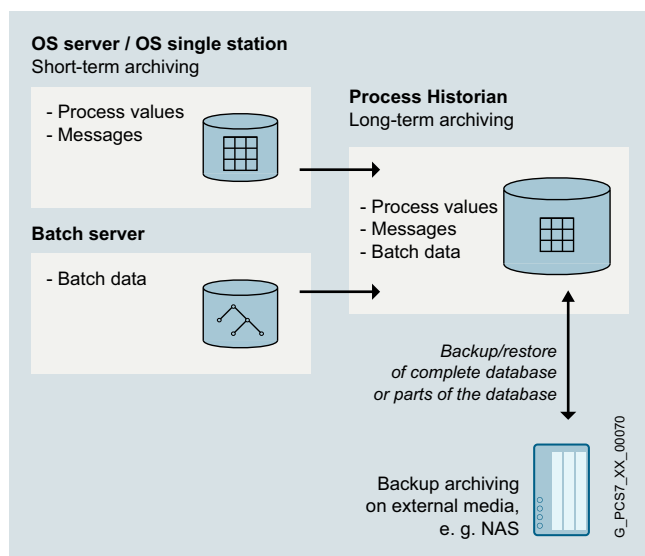

Short-term and long-term archiving

The Operator System already includes a high-performance archiving system based on Microsoft SQL Server with cyclic logs for short-term archiving of process values (typically 1 to 4 weeks) and messages (typically 2 months). Data from the cyclic logs and batch data from SIMATIC BATCH can be exported time-controlled or event-controlled to the Process Historian for permanent archiving.

The Process Historian can be expanded by an Information Server to work as a reporting system. The Information Server can optionally access the archived data in the Process Historian and in the operator stations in parallel.

Data managed in the Process Historian can be backed up on external storage media such as an NAS or an SAN. This requires additional hardware and software that the utilized operating system supports.

Benefits

Process Historian

- Scalable high-performance archiving system in SIMATIC PCS 7
- No restriction with respect to single stations, servers or server pairs that can be archived
- May be combined with Information Server for the generation of reports

Overview

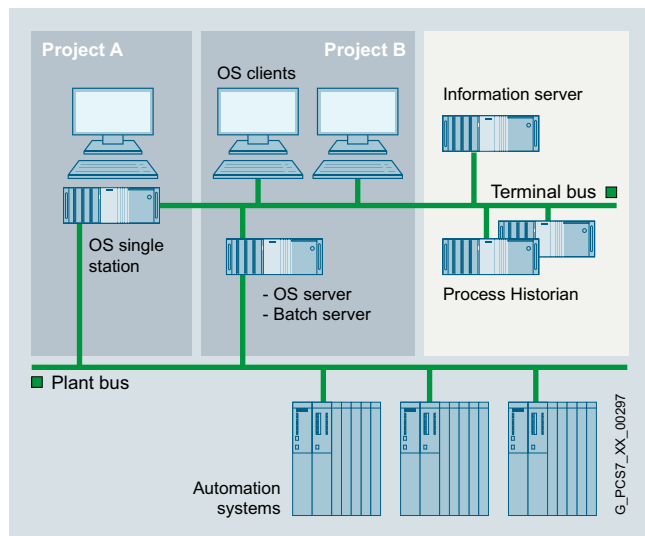

The Process Historian is used for long-term archiving of the following data from the SIMATIC PCS 7 process control system:

- OS archive data (process values and messages)
- Batch data

The process values and messages exported from the OS archives, as well as the batch data from SIMATIC BATCH are managed by the Process Historian in a central database. They can be visualized on OS clients or OS single stations either directly or with the support of the information server.

Design

Individual consultation on project-specific hardware configurations is recommended. The **PH-HW Advisor** tool is provided to determine the suitable hardware for the Process Historian:

<https://support.industry.siemens.com/cs/ww/en/view/109740115>

The PH Trend Viewer tool, which is part of the product, is helpful during initial commissioning.

The Information Server can be installed and operated on the Process Historian hardware or on separate hardware.

Process Historian and Information Server run with the Windows Server 2019 operating system; the Information Server can also run on separate hardware with Windows 10.

The Process Historian and Information Server do not need a connection to the plant bus. They can be connected to the OS and Batch Servers of the SIMATIC PCS 7 system via terminal bus, e.g. via the integrated network connection (Ethernet RJ45 port onboard) of the server.

Configuration of the Process Historian

The licenses contained in the SIMATIC PCS 7 Process Historian Basic Package or SIMATIC PCS 7 Process Historian and Information Server Basic Package products are required for configuration of the Process Historian as the long-term archive of a SIMATIC PCS 7 system. These licenses must always be stored on the Process Historian server. The SIMATIC PCS 7 Process Historian Archive BATCH software product for archiving batch data from SIMATIC BATCH can be ordered optionally.

Configuration of applicative couplings with the Process Historian

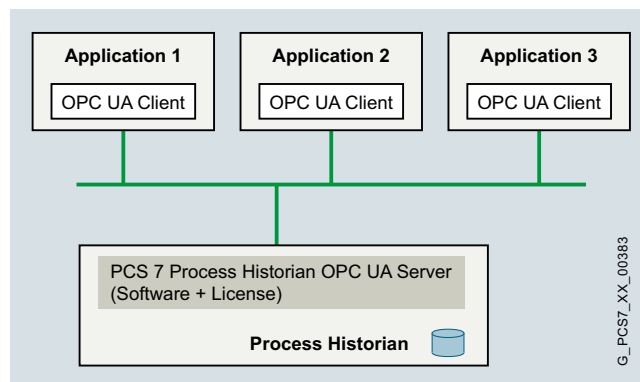

Reading of Process Historian data via OPC UA

As an OPC UA Client, any applications can read the process values and messages archived in the database of the Process Historian. A SIMATIC PCS 7 Process Historian OPC UA Server is required for this on the Process Historian (software from SIMATIC PCS 7 Software Media Package plus single license for one installation).

SIMATIC PCS 7 system software

Process data archiving and reporting

Process Historian and Information Server

Design (continued)

Configuration of the Information Server

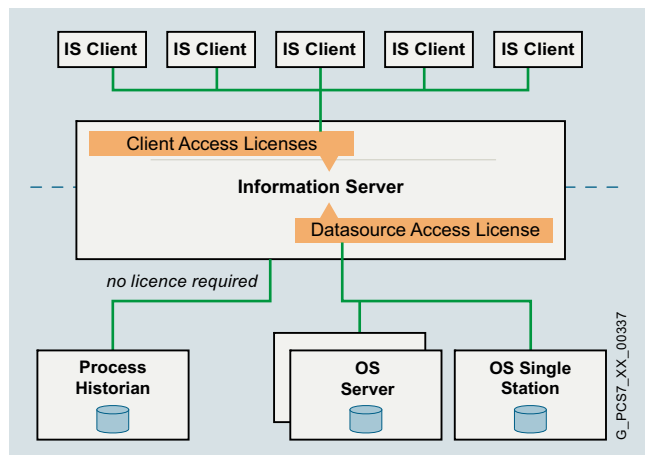

In addition to the SIMATIC PCS 7 Information Server Basic Package or the SIMATIC PCS 7 Process Historian and Information Server Basic Package, for configuration of the Information Server you require cumulative SIMATIC PCS 7 Information Server Client Access licenses corresponding to the number of clients that access the Information Server.

The Information Server is able to access one or multiple data sources in parallel. In addition to the Process Historian, this might also include archive data from operator stations (OS Single Station, OS Server). Unlike when you access the Process Historian, you need cumulative licenses for SIMATIC PCS 7 Information Server Data Source Access to read data from OS Single Stations and OS Servers. The license volume depends on the number of sources.

The installation of the SIMATIC PCS 7 Information Server Client Access and Data Source Access licenses is performed on the Information Server.

Software products/licenses

Software products/licenses	Single Server		
	Process Historian plus Information Server	Information Server	Process Historian
Software products/licenses			
SIMATIC PCS 7 Process Historian and Information Server Basic Package	1	–	–
SIMATIC PCS 7 Information Server Basic Package	–	1	–
SIMATIC PCS 7 Process Historian Basic Package	–	–	1
SIMATIC PCS 7 Process Historian Archive BATCH	1	–	1
SIMATIC PCS 7 Process Historian OPC UA Server	1	–	1
Quantity options/volume licenses			
SIMATIC PCS 7 Information Server Client Access licenses, cumulative (sets of 1, 3, 5, 10)	Licenses for 1 server	Licenses for 1 server	–
SIMATIC PCS 7 Information Server Data Source Access, cumulative source licenses (sets of 1, 3)	Licenses for 1 server	Licenses for 1 server	–

Configuration options

Function



Process Historian

The Process Historian can archive process values, messages, and batch data from the SIMATIC PCS 7 process control system. It is configured in a SIMATIC PCS 7 project similar to other stations of the SIMATIC PCS 7 process control system (e.g. OS Server, Batch Server, Route Control Server, OpenPCS 7 Server or all clients).

The process values and alarms managed in the database of the Process Historian on the OS Clients and OS Single Stations can be visualized in a clear and user-friendly manner. Data selection is supported by integrated filter functions. Messages and process values can be shown in table form, and process values also in graphic form. Tables of process values can be exported in CSV format for further processing in other Windows applications, e.g. Microsoft Excel.

Any application can access the archived process values and messages in the Process Historian via OPC UA.

The data managed by Process Historian can be transferred to external storage media (Backup/Restore). This requires additional hardware and software suitable for the operating system of the Process Historian, for example NAS.

The Process Historian also supports backup and restoring of the complete database – both manually and automatically.

Function (continued)

Archiving and visualization functions

- Real-time archiving of process values and messages from SIMATIC PCS 7 Operator Systems (OS Single Stations and OS Servers)
- Real-time archiving for the batch data of SIMATIC BATCH
- Conversion of runtime segments to archive segments:
 - Loss-free data compression
 - Reduction of segment size in accordance with assignment and release of unused storage space
- Support of multiple SIMATIC PCS 7 projects
- Scaling relative to the basic hardware used in terms of performance and configuration limits
- Export of all data as well as cataloging onto external storage media
- Reading the swapped-out data and cataloging from external storage media
- Data visualization on the OS Clients/OS Single Stations:
 - Configuration of views (picture windows and masks) including the selection criteria for displaying the data
 - Visualizing of messages in table form dependent on filter functions
 - Displaying of process values in table or graphic form dependent on filter functions
 - Visualization of a batch overview (selecting the detailed log of a batch from the batch overview is possible)

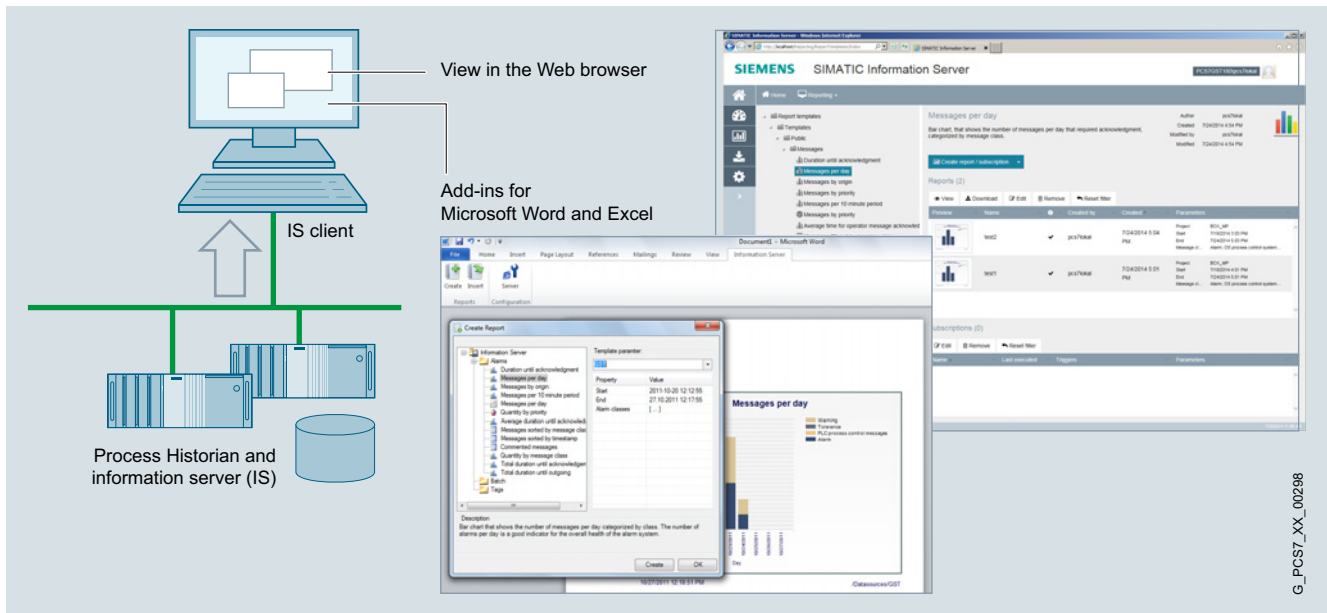

Information Server

The Information Server is the reporting system of the Process Historian. Based on the Microsoft Reporting Services, it offers web-based thin-client access to the historical data. An add-in for Microsoft Excel provides additional access to the database of the Process Historian.

Reporting functions

- Frequently used report templates for process values, messages and batches
- Open reporting system for creating any number of new report templates
- Storage of configured (parameterized) report templates for faster access
- Report export in common document formats
- Support of subscriptions for cyclic report generation including email service
- Creation and storage of dashboards including interactive controls
- Creation of Microsoft Excel reports for historical process values and messages as well as storage of the Excel report templates on the Information Server
- Support of subscriptions for Microsoft Excel report templates

SIMATIC PCS 7 system software

Process data archiving and reporting

Process Historian and Information Server

Ordering data

Article No.

Article No.

Process Historian and Information Server on shared hardware

SIMATIC PCS 7 Process Historian and Information Server Basic Package V9.1

For the shared installation of Process Historian and Information Server on an Industrial Workstation

5 languages (English, German, French, Italian, Spanish), software class A, runs with Windows Server 2019 (see SIMATIC PCS 7 Readme for the latest information¹⁾), single license for 1 installation

Without SIMATIC PCS 7 Software Media Package

- Goods delivery
License key on USB flash drive, Certificate of License
- Online delivery
License key download, online Certificate of License
Note: Email address required!

6ES7652-7AX68-2YB0

6ES7652-7AX68-2YH0

Process Historian on separate hardware

SIMATIC PCS 7 Process Historian Basic Package V9.1

For installation of the Process Historian on a Server version of the Industrial Workstation, separate from the Information Server

5 languages (English, German, French, Italian, Spanish), software class A, runs with Windows Server 2019 (see SIMATIC PCS 7 Readme for the latest information¹⁾), single license for 1 installation

Without SIMATIC PCS 7 Software Media Package

- Goods delivery
License key on USB flash drive, Certificate of License
- Online delivery
License key download, online Certificate of License
Note: Email address required!

6ES7652-7BX68-2YB0

6ES7652-7BX68-2YH0

Functional options for Process Historian

SIMATIC PCS 7 Process Historian Archive BATCH V9.1

5 languages (English, German, French, Italian, Spanish), software class A, runs with Windows Server 2019 (see SIMATIC PCS 7 Readme for the latest information¹⁾), single license for 1 installation

Without SIMATIC PCS 7 Software Media Package

- Goods delivery
License key on USB flash drive, Certificate of License
- Online delivery
License key download, online Certificate of License
Note: Email address required!

6ES7652-7DX68-2YB0

6ES7652-7DX68-2YH0

SIMATIC PCS 7 Process Historian OPC UA Server V9.1

For connection to third-party system

5 languages (English, German, French, Italian, Spanish), software class A, runs with Windows Server 2019 (see SIMATIC PCS 7 Readme for the latest information¹⁾), single license for 1 installation

Without SIMATIC PCS 7 Software Media Package

- Goods delivery
License key on USB flash drive, Certificate of License
- Online delivery
License key download, online Certificate of License
Note: Email address required!

6ES7652-7FX68-2YB0

6ES7652-7FX68-2YH0

Information Server on separate hardware

SIMATIC PCS 7 Information Server Basic Package V9.1

For installation of the Information Server on a single station or server version of the Industrial Workstation, separate from the Process Historian

5 languages (English, German, French, Italian, Spanish), software class A, runs with Windows 10 and Windows Server 2019 (see SIMATIC PCS 7 Readme for the latest information¹⁾), single license for 1 installation

Without SIMATIC PCS 7 Software Media Package

- Goods delivery
License key on USB flash drive, Certificate of License
- Online delivery
License key download, online Certificate of License
Note: Email address required!

6ES7652-7EX68-2YB0

6ES7652-7EX68-2YH0

Ordering data	Article No.
Quantity options for Information Server	
SIMATIC PCS 7 Information Server Client Access Cumulative Client Access licenses, independent of language, software class A, single license for 1 installation Without SIMATIC PCS 7 Software Media Package <ul style="list-style-type: none"> • Goods delivery License key on USB flash drive, Certificate of License <ul style="list-style-type: none"> - 1 client - 3 clients - 5 clients • Online delivery License key download, online Certificate of License <u>Note:</u> Email address required! <ul style="list-style-type: none"> - 1 client - 3 clients - 5 clients 	6ES7652-7YA00-2YB0 6ES7652-7YB00-2YB0 6ES7652-7YC00-2YB0 6ES7652-7YA00-2YH0 6ES7652-7YB00-2YH0 6ES7652-7YC00-2YH0
SIMATIC PCS 7 Information Server Data Source Access License for direct access to the archive data of operator stations (sources) Cumulative source licenses, independent of language, software class A, single license for 1 installation Without SIMATIC PCS 7 Software Media Package <ul style="list-style-type: none"> • Goods delivery License key on USB flash drive, Certificate of License <ul style="list-style-type: none"> - 1 source - 3 sources • Online delivery License key download, online Certificate of License <u>Note:</u> Email address required! <ul style="list-style-type: none"> - 1 source - 3 sources 	6ES7652-7YE00-2YB0 6ES7652-7YF00-2YB0 6ES7652-7YE00-2YH0 6ES7652-7YF00-2YH0

¹⁾ See "Software Media and Logistics" section, under "System documentation", see page 1/7

SIMATIC PCS 7 system software

Notes

6

Plant Device Management



7/2	SIMATIC PDM
7/14	SIMATIC PCS 7 Maintenance Station
7/19	SIMATIC PDM Maintenance Station
7/22	SIMATIC Plant Asset Maintenance Station

SIMATIC PCS 7 system software

Plant Device Management

SIMATIC PDM

Overview

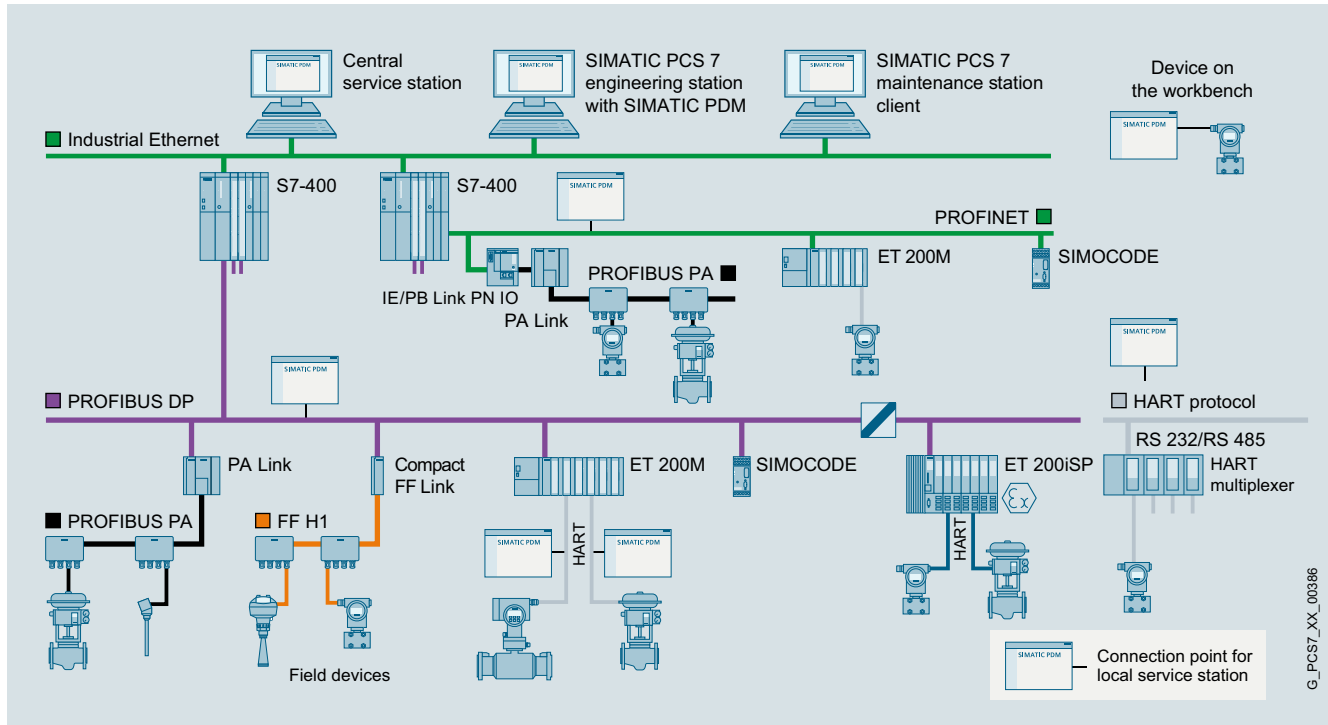

Configuration options with SIMATIC PDM

SIMATIC PDM (Process Device Manager) is a universal, vendor-independent tool for the configuration, parameter assignment, commissioning, diagnostics and servicing of intelligent field devices (sensors and actuators) and field components (remote I/Os, multiplexers, control-room devices, compact controllers), which in the following sections will be referred to simply as devices.

With *one* software product, SIMATIC PDM enables users to work with over 4 000 devices and device variants from Siemens and over 200 other manufacturers worldwide on a *single* homogeneous user interface.

The user interface satisfies the requirements of the VDI/VDE GMA 2187 and IEC 65/349/CD directives. Parameters and functions for all supported devices are displayed in a consistent and uniform fashion independent of their communications interface. Even complex devices with several hundred parameters can be represented clearly and processed quickly. Using SIMATIC PDM it is very easy to navigate in highly complex stations such as remote I/Os and even connected field devices.

From the viewpoint of device integration, SIMATIC PDM is the most powerful open process device manager on the global market. Devices not previously supported can be integrated in SIMATIC PDM by importing their device description packages (either EDD or FDI). This provides security for your investment and saves you investment costs, training expenses and follow-up costs.

SIMATIC PDM supports the operative system management in particular through:

- Uniform representation and operation of devices
- Uniform representation of diagnostics information
- Indicators for preventive maintenance and servicing
- Detection of changes in the project and device
- Increasing the operational reliability
- Reducing the investment, operating and maintenance costs
- Quantity options for
 - Transfer of parameters between devices
 - Transfer of parameter sets to the devices
 - Export and import functions
 - Diagnostics update

G_PC57_XX_00386

Overview (continued)

SIMATIC PDM can be used extremely flexibly and tailored to a specific task for field device service:

- Single-point station for point-to-point connection to field devices
- Local service and parameter assignment station with connection to fieldbus segments
- Central service and parameter assignment station with connection to plant bus
- Central HART service and parameter assignment station for HART multiplexers and WirelessHART field devices
- Integrated into the stand-alone SIMATIC PDM Maintenance Station
- Integrated into the SIMATIC PCS 7 process control system

Maintenance personnel can assign field device parameters at mobile and stationary workstations with SIMATIC PDM. Practically every workstation integrated in the production plant can be used for configuration. Service personnel are thus able to work directly at the location of the field device, while data is stored centrally in the engineering station or maintenance station. This leads to a significant shortening of maintenance and travel times. Additional device-independent system functions support higher-level maintenance stations for creating progress lists for work and servicing.

When a maintenance station is configured in the SIMATIC PCS 7 process control system, SIMATIC PDM is integrated into it and transmits parameter data, diagnostic information and processing information. You can switch directly to the SIMATIC PDM views from the diagnostics faceplates in the maintenance station to perform diagnostics and work on the device in more detail.

A SIMATIC PDM user administration system based on SIMATIC Logon is used to assign various roles with defined function privileges to users. These function privileges refer to SIMATIC PDM system functions, e.g. writing to the device.

For all devices integrated with device description packages, SIMATIC PDM provides a range of information for display and further processing on the maintenance station, for example:

- Device type information (electronic rating plate)
- Detailed diagnostics information (manufacturer information, information on error diagnostics and troubleshooting, further documentation)
- Results of internal condition monitoring functions
- Status information (for example local configuration changes), device test completed
- Information on changes (audit trail report)
- Parameter information

SIMATIC PCS 7 system software

Plant Device Management

SIMATIC PDM

Design

Components	Product packages							
	SIMATIC PDM Stand alone				SIMATIC PDM system-integrated			
	Minimum configuration	Basic configuration	Service and parameter assignment station		in the configuration environment			
			local	central	SIMATIC S7		SIMATIC PCS 7	
PDM Single Point	PDM Basic	PDM Service	PDM Stand alone Server	PDM S7	PDM PCS 7	PDM PCS 7 Server	PDM PCS 7 FF	
SIMATIC PDM TAGs ¹⁾ in scope of supply	1	4	4 + 50	4 + 100	4 + 100	4 + 100	4 + 100	4 + 100
SIMATIC PDM expansion options								
Count Relevant - 10 TAGs Licenses - 100 TAGs (accumulative) - 1 000 TAGs	<i>cannot be expanded</i>	o	o	o	o	o	o	o
SIMATIC PDM Basic	●	●	●	●	●	●	●	●
SIMATIC PDM Extended	o	o	●	●	●	●	●	●
SIMATIC PDM integration in STEP 7/PCS 7	o	o	o	●	●	●	●	●
SIMATIC PDM Routing ²⁾	●	●	●	o	●	●	●	●
SIMATIC PDM Server	o	o	●	o	o	●	o	o
SIMATIC PDM 1 Client ³⁾	o	o	● (2 x)	o	o	o	o	o
SIMATIC PDM Communication FOUNDATION Fieldbus	–	–	–	o	o	o	●	o
SIMATIC PDM HART Server	o	o	o	o	–	–	–	–

SIMATIC PDM product structure

- Product component is part of the product package
 - o Optional product component for the product package; order additive
 - Product component is not relevant for the product package or not available
- 1) For TAG definition, see Design section under "SIMATIC PDM TAGs"
 2) In combination with SIMATIC PDM Integration in STEP 7/PCS 7
 3) In combination with SIMATIC PDM Server

Customer-oriented product structure

The customer-oriented product structure of SIMATIC PDM provides optimal support for the named main use cases and enables you to adapt the scope of functions and performance to your individual requirements. The product range is organized as follows:

SIMATIC PDM Stand alone product packages

- SIMATIC PDM Single Point, a minimum configuration for single device handling
- SIMATIC PDM Basic for local service and parameter assignment stations as well as basic configuration for individual product package with optional product components
- SIMATIC PDM Service for local service and parameter assignment stations
- SIMATIC PDM Stand alone Server for central service and parameter assignment stations, e.g. for various plant units

SIMATIC PDM system-integrated product packages

- SIMATIC PDM S7 for local SIMATIC S7 engineering and service stations
- Various configurations for central SIMATIC PCS 7 engineering and service stations:
 - SIMATIC PDM PCS 7
 - SIMATIC PDM PCS 7 Server (enables device parameter assignment and diagnostics on clients of the PCS 7 engineering station and PCS 7 Maintenance Station)
 - SIMATIC PDM PCS 7-FF (supports the FOUNDATION Fieldbus H1)

In some circumstances, the product packages can be expanded with optional product components (for details, see the Design section).

Design (continued)

Product range	SIMATIC PDM V9.2							
	Single Point	Basic	Service	Stand alone Server	S7	PCS 7	PCS 7 Server	PCS 7-FF
TAGs contained	1	4	4 + 50	4 + 100	4 + 100	4 + 100	4 + 100	4 + 100
Project: Create offline	●	●	●	●	●	●	●	●
Project: Usable TAG extensions	–	●	●	●	●	●	●	●
Project: Process device network view	●	●	●	●	●	●	●	●
Project: Process device plant view	●	●	●	●	●	●	●	●
Project: Export/import devices	–	–	●	●	–	–	–	–
Project: Export/import parameters	–	○	●	●	●	●	●	●
Project: HW Config	–	○	○	○	●	●	●	●
Project: Utilization of SIMATIC PDM options	–	●	●	●	●	●	●	●
Project: Integration in STEP 7/PCS 7	–	○	○	○	●	●	●	●
Group operations	–	○	○	●	○	●	●	●
Setting device IDs	–	○	○	●	○	●	●	●
Communication: HART modem	●	●	●	●	●	–	–	–
Communication: HART interface	●	●	●	●	●	–	–	–
Communication: PROFIBUS DP/PA	●	●	●	●	●	●	●	●
Communication: HART over PROFIBUS DP	●	●	●	●	●	●	●	●
Communication: FF H1	–	–	–	–	○	○	○	●
Communication: Modbus	●	●	●	●	●	●	●	●
Communication: Ethernet	●	●	●	●	●	●	●	●
Communication: PROFINET	●	●	●	●	●	●	●	●
Communication: HART over PROFINET	●	●	●	●	●	●	●	●
Devices: Export/import parameters	–	○	○	●	●	●	●	●
Devices: Comparison of parameter values	–	○	○	●	●	●	●	●
Devices: Saving parameters	●	●	●	●	●	●	●	●
Devices: Change log (Audit Trail)	–	○	○	●	●	●	●	●
Devices: Calibration report	–	○	○	●	●	●	●	●
Devices: Print function	●	○	○	●	●	●	●	●
Devices: Document manager	–	○	○	●	●	●	●	●
Lifelist: Basic functionality	●	●	●	●	●	●	●	●
Lifelist: Expanded functionality (scan range, diagnostics, export, addressing)	–	○	○	●	●	●	●	●
Communication: Data record routing	–	○	○	○	○	●	●	●
Communication: HART multiplexer	–	○	○	○	○	–	–	–
Communication: WirelessHART	–	○	○	○	○	–	–	–
Function: HART SHC mode (increased communication speed)	●	●	●	●	●	●	●	●
Function: Device parameterization on PCS 7 Maintenance Station Clients	–	○	○	○	○	○	●	○
Function: Device parameterization on SIMATIC PDM Clients	–	○	○	● (2 x)	○	○	○	○

SIMATIC PDM overview of functions and features

- Product component is part of the product package
- Optional product component for the product package; order additive
- Product component is not relevant for the product package or not available

SIMATIC PCS 7 system software

Plant Device Management

SIMATIC PDM

Overview (continued)

SIMATIC PDM Stand alone product packages

SIMATIC PDM Single Point V9.2

This minimum configuration with handheld functionality is intended for handling exactly *one* field device via point-to-point coupling. It cannot be expanded with functions or with SIMATIC PDM TAG or SIMATIC PDM 1 Client licenses. Upgrading to a different product variant, e.g. SIMATIC PDM Basic, or a different product version is also not possible.

Supported communication types:

- PROFIBUS DP/PA
- HART communication (modem, RS 232 and via PROFIBUS/PROFINET)
- Modbus
- Ethernet
- PROFINET

The functionality is matched accordingly. The device functions are supported as defined in the device description, for example:

- Managing the device library and unlimited device selection
- Parameter assignment and diagnostics according to the device description
- Exporting and importing of parameter data
- Device identification
- Lifelist
- Printing the parameter list

SIMATIC PDM Basic V9.2

SIMATIC PDM Basic is for local service and parameter assignment stations on any computers (IPC/notebook) with local connection to bus segments or direct connection to the device.

Supported communication types:

- PROFIBUS DP/PA
- HART communication (modem, RS 232 and via PROFIBUS/PROFINET)
- Modbus
- Ethernet
- PROFINET

SIMATIC PDM Basic is equipped with all basic functions required for operation and parameter assignment of devices. That is, compared to SIMATIC PDM Single Point, it has the following additional functions:

- EDD-based diagnostics in the lifelist
- Memory function (only exporting and importing of parameter data)
- Report function
- Communication with HART field devices via remote I/Os

As a basic block for an individual configuration, SIMATIC PDM Basic can be expanded with all functional SIMATIC PDM options (PDM Routing only required in combination with PDM Integration in STEP 7/PCS 7) as well as with cumulative sets of 10, 100 or 1 000 SIMATIC PDM TAGs. Without TAG expansion, SIMATIC PDM Basic is suitable for projects with up to 4 TAGs. SIMATIC PDM 1 Client licenses (sets of 1) can also be added in combination with the SIMATIC PDM Server option.

The SIMATIC PDM Extended option allows the activation of additional SIMATIC PDM system functions (for details, see SIMATIC PDM Extended V9.2 under "Optional product components").

SIMATIC PDM Service V9.2

With this product package for extended service, local service and parameter assignment stations can be realized on any type of computer (IPC/notebook) with a local connection to a bus segment or direct connection to field devices.

It comprises:

- SIMATIC PDM Basic (incl. 4 SIMATIC PDM TAGs)
- 50 SIMATIC PDM TAGs

Like SIMATIC PDM Basic, SIMATIC PDM Service can be expanded with all functional SIMATIC PDM options (PDM Routing only in combination with PDM Integration in STEP 7/PCS 7 required) as well as with cumulative SIMATIC PDM TAGs (sets of 10, 100 or 1 000) (see "Optional product components"). SIMATIC PDM 1 Client licenses (sets of 1) can also be added in combination with the SIMATIC PDM Server option. It is permitted to upgrade to another product version.

Note: For use of gateways and for PROFINET or Ethernet communication with field devices, SIMATIC PDM TAG licenses are charged for according to the objects configured in the process device plant view as follows:

- 10 SIMATIC PDM TAGs per S7 DSGW (data record gateway) with one PROFIBUS subnet
- 20 SIMATIC PDM TAGs per S7 DSGW with more than one PROFIBUS subnet
- 10 TAGs per IE/PB Link
- 1 TAG per field device (except in the case of special specifications)

SIMATIC PDM Stand-alone Server V9.2

With the SIMATIC PDM Stand alone Server product package, you can establish central service and parameter assignment stations that operate according to the client/server principle. Portals opened on licensed SIMATIC PDM Clients (SIMATIC PDM sessions) enable handling of production plant field devices via the SIMATIC PDM Server on the plant bus assigned via registration. The product package can be used multiple times within a plant, e.g. for various plant units. It comprises:

- SIMATIC PDM Basic (incl. 4 SIMATIC PDM TAGs)
- SIMATIC PDM Extended
- SIMATIC PDM Server
- 2 × SIMATIC PDM 1 Client
- 100 SIMATIC PDM TAGs

SIMATIC PDM Stand alone Server can be expanded with all functional SIMATIC PDM options (PDM Routing only in combination with PDM Integration in STEP 7/PCS 7 required) as well as with cumulative sets of 10, 100 or 1 000 SIMATIC PDM TAGs and SIMATIC PDM 1 Client Licenses (see "Optional product components"). The portals opened on these clients (SIMATIC PDM sessions) must also be licensed with the SIMATIC PDM 1 Client Licenses besides the SIMATIC PDM Clients. For details about this, refer to "SIMATIC PDM 1 Client" under "Optional product components". For user management of the SIMATIC PDM Clients, the SIMATIC Logon product is also required. It is possible to upgrade to another product version.

Note: For use of gateways and for PROFINET or Ethernet communication with field devices, SIMATIC PDM TAG licenses are charged according to the objects configured in the process device plant view (for details, see corresponding note under SIMATIC PDM Service V9.2).

Overview (continued)

SIMATIC PDM system-integrated product packages
SIMATIC PDM S7 V9.2

The SIMATIC PDM S7 product package designed for use in a SIMATIC S7 configuration environment is intended for setup of a local SIMATIC S7 engineering and service station. It requires the installation of STEP 7 V5.5+SP4. It includes:

- SIMATIC PDM Basic (incl. 4 SIMATIC PDM TAGs)
- SIMATIC PDM Extended
- SIMATIC PDM integration in STEP 7/PCS 7
- 100 SIMATIC PDM TAGs

SIMATIC PDM S7 can be expanded with the functional options SIMATIC PDM Routing, SIMATIC PDM Communication FOUNDATION Fieldbus, SIMATIC PDM Server, and SIMATIC PDM HART Server as well as with cumulative SIMATIC PDM TAGs (sets of 10, 100 or 1 000) (see "Optional product components"). SIMATIC PDM 1 Client licenses (sets of 1) can also be added in combination with the SIMATIC PDM Server option.

SIMATIC PDM PCS 7 V9.2

The SIMATIC PDM PCS 7 product package suitable for use in a SIMATIC PCS 7 configuration environment is intended for use in a central SIMATIC PCS 7 engineering and service station. It comprises:

- SIMATIC PDM Basic (incl. 4 SIMATIC PDM TAGs)
- SIMATIC PDM Extended
- SIMATIC PDM integration in STEP 7/PCS 7
- SIMATIC PDM Routing
- 100 SIMATIC PDM TAGs

SIMATIC PDM PCS 7 can be expanded with the functional options SIMATIC PDM Communication FOUNDATION Fieldbus and SIMATIC PDM Server as well as with cumulative SIMATIC PDM TAGs (sets of 10, 100 or 1000) (see "Optional product components"). SIMATIC PDM 1 Client licenses (sets of 1) can also be added in combination with the SIMATIC PDM Server option.

SIMATIC PDM PCS 7 Server V9.2

Instead of SIMATIC PDM PCS 7, the SIMATIC PDM PCS 7 Server product package expanded with the SIMATIC PDM Server option can also be used for a central SIMATIC PCS 7 engineering and service station. Field devices integrated using an Electronic Device Description (EDD) can then be assigned parameters on any client of the SIMATIC PCS 7 Maintenance Station as well as on local SIMATIC PDM Clients. The following are components of SIMATIC PDM PCS 7 Server:

- SIMATIC PDM Basic (incl. 4 SIMATIC PDM TAGs)
- SIMATIC PDM Extended
- SIMATIC PDM integration in STEP 7/PCS 7
- SIMATIC PDM Routing
- SIMATIC PDM Server
- 100 SIMATIC PDM TAGs

SIMATIC PDM PCS 7 Server can be expanded with the functional option SIMATIC PDM Communication FOUNDATION Fieldbus as well as with cumulative sets of 10, 100 or 1 000 SIMATIC PDM TAGs and SIMATIC PDM 1 Client Licenses (see "Optional product components"). The portals opened on these clients (SIMATIC PDM sessions) must also be licensed with the SIMATIC PDM 1 Client Licenses besides the SIMATIC PDM Clients. For details about this, refer to "SIMATIC PDM 1 Client" under "Optional product components".

SIMATIC PDM PCS 7-FF V9.2

Instead of SIMATIC PDM PCS 7, the SIMATIC PDM PCS 7-FF product package expanded with the SIMATIC PDM Communication FOUNDATION Fieldbus option can also be used for a central SIMATIC PCS 7 engineering and service station. This additionally supports parameter assignment of field devices on FOUNDATION Fieldbus H1. Components of SIMATIC PDM PCS 7-FF are:

- SIMATIC PDM Basic (incl. 4 SIMATIC PDM TAGs)
- SIMATIC PDM Extended
- SIMATIC PDM integration in STEP 7/PCS 7
- SIMATIC PDM Routing
- SIMATIC PDM Communication FOUNDATION Fieldbus
- 100 SIMATIC PDM TAGs

SIMATIC PDM PCS 7-FF V9.2 can be expanded with the functional option SIMATIC PDM Server as well as with cumulative sets of 10, 100 or 1 000 SIMATIC PDM TAGs (see "Optional product components"). SIMATIC PDM 1 Client licenses (sets of 1) can also be added in combination with the SIMATIC PDM Server option.

Optional product components
Option SIMATIC PDM Extended V9.2

The SIMATIC PDM Extended option enables you to unlock other system functions for SIMATIC PDM Basic and SIMATIC PDM, for example:

- Change log
- Calibration report
- Extended information in the Lifelist
- Export and import functions
- Print functions
- Document manager
- Comparison function
- Group operations
- Setting device IDs

This functionality is already integrated in the following product packages: SIMATIC PDM Stand alone Server, SIMATIC PDM S7, SIMATIC PDM PCS 7, SIMATIC PDM PCS 7 Server and SIMATIC PDM PCS 7-FF.

Option SIMATIC PDM Integration in STEP 7/PCS 7 V9.2

This option is used for the integration of SIMATIC PDM in a SIMATIC S7 or SIMATIC PCS 7 configuration environment. SIMATIC PDM can then be started directly from the hardware configurator (HW Config) in STEP 7/SIMATIC PCS 7.

This functionality is already integrated in the product packages of category "SIMATIC PDM system-integrated" (SIMATIC PDM S7, SIMATIC PDM PCS 7, SIMATIC PDM PCS 7 Server, and SIMATIC PDM PCS 7-FF).

SIMATIC PCS 7 system software

Plant Device Management

SIMATIC PDM

Design (continued)

Option SIMATIC PDM Routing V9.2

If SIMATIC PDM is used on an engineering station, the SIMATIC PDM Routing option enables handling of every device in the field that can be configured per EDD throughout the plant and across different bus systems and remote I/Os. SIMATIC PDM Routing can be used in combination with SIMATIC PDM Integration in STEP 7/SIMATIC PCS 7.

Routing is already integrated in SIMATIC PDM PCS 7, SIMATIC PDM PCS 7 Server, and SIMATIC PDM PCS 7-FF. SIMATIC PDM Routing can be additionally installed as an option on a local SIMATIC S7 engineering and service station with SIMATIC PDM S7.

Option SIMATIC PDM Server V9.2

The server functionality can be activated in a local or central service station with this option. It enables parameter assignment of selected field devices on any client of the SIMATIC PCS 7 Maintenance Station as well as on local SIMATIC PDM Clients. This functionality is already integrated in the SIMATIC PDM Stand alone Server and SIMATIC PDM PCS 7 Server. The SIMATIC PDM Clients as well as the portals opened on these clients (SIMATIC PDM sessions) must be licensed with SIMATIC PDM 1 Client licenses. For details about this, refer to "SIMATIC PDM 1 Client" under "Optional product components".

Option SIMATIC PDM Communication FOUNDATION Fieldbus V9.2

In a SIMATIC S7/PCS 7 configuration environment, using this option SIMATIC PDM can communicate with field devices on the FOUNDATION Fieldbus H1 via the FF link.

This functionality is already integrated in the SIMATIC PDM PCS 7-FF product package.

Option SIMATIC PDM HART Server V9.2

This option permits the use of HART multiplexers from various vendors in SIMATIC PDM. Furthermore, WirelessHART field devices can also be parameterized with SIMATIC PDM.

Option SIMATIC PDM Command Interface V9.2

With this option, SIMATIC PDM configurations for stand-alone operation (based on the SIMATIC PDM Basic or SIMATIC PDM Service product package) can be remote-controlled with regard to configuration and field device operation.

Note: You cannot order the SIMATIC PDM Command Interface option. It is only intended for project-specific use and not for mass use. Programming knowledge is necessary.

SIMATIC PDM TAGs (version-independent)

Depending on the project size, the SIMATIC PDM TAGs supplied with a product package (except SIMATIC PDM Single Point) can be cumulatively expanded with sets of 10, 100 or 1 000 SIMATIC PDM TAGs.

A SIMATIC PDM TAG corresponds to a SIMATIC PDM object that represents the individual field devices or field components within a project, e.g. measuring instruments, positioners, switching devices or remote I/Os. SIMATIC PDM TAGs are also relevant for diagnostics with the lifelist of SIMATIC PDM. In this case, TAGs are considered to be all recognized devices with diagnostics capability, whose detailed diagnostics is effected through the device description (EDD).

SIMATIC PDM 1 Client (version-independent)

SIMATIC PDM 1 Client is a cumulative single-client license for SIMATIC PDM configurations with SIMATIC PDM Server, for example SIMATIC PDM Stand alone Server or SIMATIC PDM PCS 7 Server. The license is used to activate registered SIMATIC PDM Clients and SIMATIC PDM Sessions (opened portals) on these clients.

Each "SIMATIC PDM 1 Client" license activates one SIMATIC PDM Client with one SIMATIC PDM session. A SIMATIC PDM session is defined as one opened portal together with the parameter views of the field devices opened from the portal. Each additional simultaneously opened SIMATIC PDM session on this client requires its own "SIMATIC PDM 1 Client" license. For larger projects, up to 30 registered SIMATIC PDM Clients are possible.

The "SIMATIC PDM 1 Client" license must be transferred to the computer with the SIMATIC PDM Server. The SIMATIC PDM Standalone Server product package comes with 2 "SIMATIC PDM 1 Client" licenses.

SIMATIC PDM Software Media Package V9.2

The current SIMATIC PDM installation software is offered without a license in the form of the SIMATIC PDM Software Media Package. Purchasing of corresponding software licenses is necessary to unlock the product-specific functionalities.

With SIMATIC PDM product packages, a SIMATIC PDM Software Media Package is supplied together with each ordering item when supplied via "goods delivery" (not with optional product components). Further SIMATIC PDM Software Media Packages must be ordered separately as required.

The software of the SIMATIC PDM Media Package without a license can be used for demonstration purposes in demo mode. The SIMATIC PDM functionality is limited as follows in demo mode:

- Stand alone mode
- Storage functions disabled
- Export and import functions disabled
- Expanded functionality disabled
- Communication functions restricted

Information on ordering and delivery

Installation software for the SIMATIC PDM is provided in the form of a software media package. Software media packages and product-specific software licenses are separate packages, which are not merged into a single delivery unit for a goods delivery.

The number of delivered software media packages can be determined by the number of ordered items. You can find more information under "Goods delivery" in the section "Software Media and Logistics", subsection "PCS 7 Software Packages" in the ST PCS 7 catalog.

Function

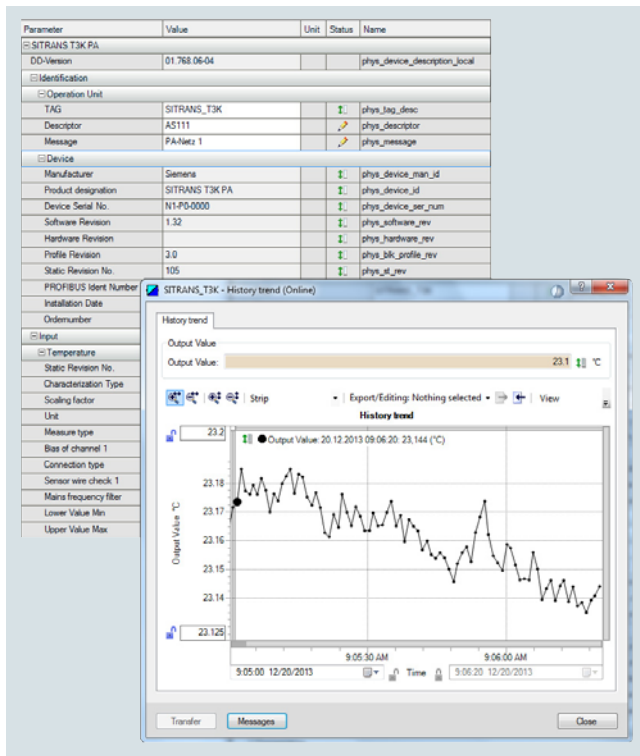

SIMATIC PDM, parameter view and trend window

SIMATIC PDM core functions

- Creation of project-specific device libraries
- Adjustment and modification of device parameters
- Comparing (e.g. project and device data)
- Plausibility testing of data input
- Device identification and testing
- Device status indication (operating modes, interrupts, states)
- Simulation
- Diagnostics (standard, detailed)
- Export/import (parameter data, logs, documents)
- Management (e.g. networks and PCs)
- Commissioning functions, e.g. measuring circuit tests of device data
- Lifecycle management functions, e.g. for device replacement
- Global and device-specific modification logbook for user operations (audit trail)
- Device-specific calibration reports
- Graphic presentations of echo envelope curves, trend displays, valve diagnosis results etc.
- Presentation of incorporated manuals
- Document manager for integration of up to 10 multimedia files

Integration

Device integration

SIMATIC PDM supports all devices defined by the Electronic Device Description (EDD) and devices described by Field Device Integration Technology (FDI Technology V1.2). EDD is standardized to EN 50391 and IEC 61804. Internationally it is the most widely used standardized technology for device integration. At the same time, it is the guideline of the established organizations for

- PROFIBUS and PROFINET (PI – PROFIBUS & PROFINET International)
- HART (FCG: Field Communication Group)
- Foundation Fieldbus (FCG: Field Communication Group)

The devices are integrated directly in SIMATIC PDM through a company-specific EDD or through the libraries of the FCG. To achieve improved transparency, they can be managed in project-specific device libraries.

Field devices are described in the EDD or FDI device description packages in terms of functionality and construction using the Electronic Device Description Language (EDDL). Using this description, SIMATIC PDM automatically creates its user interfaces with the specific device data. By simply importing the manufacturer's device-specific device description packages, you can update existing devices and integrate further devices in SIMATIC PDM.

Technical support

If you wish to use devices which cannot be found in the SIMATIC PDM device description library, we would be pleased to help you integrate them.

Support Request

You can request support by service specialists at Technical Support by using a "Support Request" on the Internet:

<http://www.siemens.com/automation/support-request>

Contacts in the Region

The Technical Support responsible for your Region can be found on the Internet at:

<http://www.automation.siemens.com/partner>

SIMATIC PCS 7 system software

Plant Device Management

SIMATIC PDM

Ordering data

Article No.

Article No.

SIMATIC PDM Stand alone product packages

Minimum configuration

SIMATIC PDM Single Point V9.2 including 1 TAG; product package for operation and configuration of one field device; communication via PROFIBUS DP/PA, HART (modem, RS 232, PROFIBUS/PROFINET), Modbus, Ethernet or PROFINET

Additional functions or SIMATIC PDM TAGs are not possible

6 languages (English, German, French, Italian, Spanish, Chinese), software class A, runs with Windows 10 Professional 64-bit, Windows 10 Enterprise 2019 LTSC 64-bit, for operation within the product family SIMATIC PCS 7 the specifications there take precedence, (see SIMATIC PDM V9.2 Readme for the latest information), floating license for 1 user

Without SIMATIC PCS 7 Software Media Package

- Goods delivery
License key on USB flash drive and Certificate of License, bundle with 1 × SIMATIC PDM Software Media Package per order item
- Online delivery
License key download and online Certificate of License combined with SIMATIC PDM Software Media Package (SIMATIC PDM and device library software download)
Note: Email address required!

6ES7658-3HA78-0YA5

6ES7658-3HA78-0YH5

Basic configuration for individual product packages

SIMATIC PDM Basic V9.2 including 4 TAGs; product package for operation and configuration of field devices and components; communication via PROFIBUS DP/PA, HART (modem, RS 232, PROFIBUS/PROFINET), Modbus, Ethernet or PROFINET

6 languages (English, German, French, Italian, Spanish, Chinese), software class A, runs with Windows 10 Professional 64-bit, Windows 10 Enterprise 2019 LTSC 64-bit, for operation within the product family SIMATIC PCS 7 the specifications there take precedence, (see SIMATIC PDM V9.2 Readme for the latest information), floating license for 1 user

Without SIMATIC PCS 7 Software Media Package

- Goods delivery
License key on USB flash drive and Certificate of License, bundle with 1 × SIMATIC PDM Software Media Package per order item
- Online delivery
License key download and online Certificate of License combined with SIMATIC PDM Software Media Package (SIMATIC PDM and device library software download)
Note: Email address required!

6ES7658-3AB78-0YA5

6ES7658-3AB78-0YH5

Configuration for a local service and parameter assignment station

SIMATIC PDM Service V9.2

Product package for service and measuring circuit tests on a local service station, with

- SIMATIC PDM Basic incl. 4 TAGs
- 50 TAGs

6 languages (English, German, French, Italian, Spanish, Chinese), software class A, runs with Windows 10 Professional 64-bit, Windows 10 Enterprise 2019 LTSC 64-bit, for operation within the product family SIMATIC PCS 7 the specifications there take precedence, (see SIMATIC PDM V9.2 Readme for the latest information), floating license for 1 user

Without SIMATIC PCS 7 Software Media Package

- Goods delivery
License key on USB flash drive and Certificate of License, bundle with 1 × SIMATIC PDM Software Media Package per order item
- Online delivery
License key download and online Certificate of License combined with SIMATIC PDM Software Media Package (SIMATIC PDM and device library software download)
Note: Email address required!

6ES7658-3JD78-0YA5

6ES7658-3JD78-0YH5

Configuration for a central service and parameter assignment station

SIMATIC PDM Stand-alone Server V9.2

Product package for service and device management in plant units, with

- SIMATIC PDM Basic incl. 4 TAGs
- SIMATIC PDM Extended
- SIMATIC PDM Server
- 2 × SIMATIC PDM 1 Client
- 100 TAGs

6 languages (English, German, French, Italian, Spanish, Chinese), software class A, runs with Windows 10 Professional 64-bit, Windows 10 Enterprise 2019 LTSC 64-bit, for operation within the product family SIMATIC PCS 7 the specifications there take precedence, (see SIMATIC PDM V9.2 Readme for the latest information), single license for 1 installation

Without SIMATIC PCS 7 Software Media Package

- Goods delivery
License key on USB flash drive and Certificate of License, bundle with 1 × SIMATIC PDM Software Media Package per order item
- Online delivery
License key download and online Certificate of License combined with SIMATIC PDM Software Media Package (SIMATIC PDM and device library software download)
Note: Email address required!

6ES7658-3TX78-0YA5

6ES7658-3TX78-0YH5

Ordering data	Article No.	Article No.	
<p>SIMATIC PDM system-integrated product packages</p> <p>Configuration for integration in SIMATIC S7 configuration environment</p> <p>SIMATIC PDM S7 V9.2 Product package for use in a SIMATIC S7 configuration environment, with</p> <ul style="list-style-type: none"> - SIMATIC PDM Basic incl. 4 TAGs - SIMATIC PDM Extended - SIMATIC PDM Integration in STEP 7/PCS 7 - 100 TAGs <p>6 languages (English, German, French, Italian, Spanish, Chinese), software class A, runs with Windows 10 Professional 64-bit, Windows 10 Enterprise 2019 LTSC 64-bit, for operation within the product family SIMATIC PCS 7 the specifications there take precedence, (see SIMATIC PDM V9.2 Readme for the latest information), floating license for 1 user</p> <p>Without SIMATIC PCS 7 Software Media Package</p> <ul style="list-style-type: none"> • Goods delivery License key on USB flash drive and Certificate of License, bundle with 1 x SIMATIC PDM Software Media Package per order item • Online delivery License key download and online Certificate of License combined with SIMATIC PDM Software Media Package (SIMATIC PDM and device library software download) <u>Note:</u> Email address required! 	<p>6ES7658-3KD78-0YA5</p> <p>6ES7658-3KD78-0YH5</p>	<p>SIMATIC PDM PCS 7-FF V9.2 Product package for use in a SIMATIC PCS 7 configuration environment, including FOUNDATION Fieldbus H1 communication</p> <p>6 languages (English, German, French, Italian, Spanish, Chinese), software class A, runs with Windows 10 Professional 64-bit, Windows 10 Enterprise 2019 LTSC 64-bit, for operation within the product family SIMATIC PCS 7 the specifications there take precedence, (see SIMATIC PDM V9.2 Readme for the latest information)</p> <p>Floating license for 1 user, with</p> <ul style="list-style-type: none"> - SIMATIC PDM Basic incl. 4 TAGs - SIMATIC PDM Extended - SIMATIC PDM Integration in STEP 7/PCS 7 - SIMATIC PDM Routing - SIMATIC PDM Communication FOUNDATION Fieldbus - 100 TAGs <p>Without SIMATIC PCS 7 Software Media Package</p> <ul style="list-style-type: none"> • Goods delivery License key on USB flash drive and Certificate of License, bundle with 1 x SIMATIC PDM Software Media Package per order item • Online delivery License key download and online Certificate of License combined with SIMATIC PDM Software Media Package (SIMATIC PDM and device library software download) <u>Note:</u> Email address required! 	<p>6ES7658-3MD78-0YA5</p> <p>6ES7658-3MD78-0YH5</p>
<p>Configuration for integration in SIMATIC PCS 7 configuration environment</p> <p>SIMATIC PDM PCS 7 V9.2 Product package for use in a SIMATIC PCS 7 configuration environment</p> <p>6 languages (English, German, French, Italian, Spanish, Chinese), software class A, runs with Windows 10 Professional 64-bit, Windows 10 Enterprise 2019 LTSC 64-bit, for operation within the product family SIMATIC PCS 7 the specifications there take precedence, (see SIMATIC PDM V9.2 Readme for the latest information)</p> <p>Floating license for 1 user, with</p> <ul style="list-style-type: none"> - SIMATIC PDM Basic incl. 4 TAGs - SIMATIC PDM Extended - SIMATIC PDM Integration in STEP 7/PCS 7 - SIMATIC PDM Routing - 100 TAGs <p>Without SIMATIC PCS 7 Software Media Package</p> <ul style="list-style-type: none"> • Goods delivery License key on USB flash drive and Certificate of License, bundle with 1 x SIMATIC PDM Software Media Package per order item • Online delivery License key download and online Certificate of License combined with SIMATIC PDM Software Media Package (SIMATIC PDM and device library software download) <u>Note:</u> Email address required! 	<p>6ES7658-3LD78-0YA5</p> <p>6ES7658-3LD78-0YH5</p>	<p>SIMATIC PDM PCS 7 Server V9.2 Product package for use in a SIMATIC PCS 7 configuration environment, including server functionality</p> <p>6 languages (English, German, French, Italian, Spanish, Chinese), software class A, runs with Windows 10 Professional 64-bit, Windows 10 Enterprise 2019 LTSC 64-bit, for operation within the product family SIMATIC PCS 7 the specifications there take precedence, (see SIMATIC PDM V9.2 Readme for the latest information)</p> <p>Single license for 1 installation, with</p> <ul style="list-style-type: none"> - SIMATIC PDM Basic incl. 4 TAGs - SIMATIC PDM Extended - SIMATIC PDM Integration in STEP 7/PCS 7 - SIMATIC PDM Routing - SIMATIC PDM Server - 100 TAGs <p>Without SIMATIC PCS 7 Software Media Package</p> <ul style="list-style-type: none"> • Goods delivery License key on USB flash drive and Certificate of License, bundle with 1 x SIMATIC PDM Software Media Package per order item • Online delivery License key download and online Certificate of License combined with SIMATIC PDM Software Media Package (SIMATIC PDM and device library software download) <u>Note:</u> Email address required! 	<p>6ES7658-3TD78-0YA5</p> <p>6ES7658-3TD78-0YH5</p>

SIMATIC PCS 7 system software

Plant Device Management

SIMATIC PDM

Ordering data

Article No.

Article No.

Optional product components for SIMATIC PDM

SIMATIC PDM Extended V9.2

For enabling additional system functions

6 languages (English, German, French, Italian, Spanish, Chinese), software class A, runs with Windows 10 Professional 64-bit, Windows 10 Enterprise 2019 LTSC 64-bit, for operation within the product family SIMATIC PCS 7 the specifications there take precedence, (see SIMATIC PDM V9.2 Readme for the latest information), floating license for 1 user

Without SIMATIC PCS 7/SIMATIC PDM Software Media Package

- Goods delivery
License key on USB flash drive and Certificate of License
- Online delivery
(without SIMATIC PCS 7/SIMATIC PDM Software Media Package)
License key download and online Certificate of License
Note: Email address required!

6ES7658-3NX78-2YB5

6ES7658-3NX78-2YH5

SIMATIC PDM Integration in STEP 7/SIMATIC PCS 7 V9.2

For integration in a SIMATIC S7/SIMATIC PCS 7 configuration environment

6 languages (English, German, French, Italian, Spanish, Chinese), software class A, runs with Windows 10 Professional 64-bit, Windows 10 Enterprise 2019 LTSC 64-bit, for operation within the product family SIMATIC PCS 7 the specifications there take precedence, (see SIMATIC PDM V9.2 Readme for the latest information), floating license for 1 user

Without SIMATIC PCS 7/SIMATIC PDM Software Media Package

- Goods delivery
License key on USB flash drive and Certificate of License
- Online delivery
License key download and online Certificate of License
Note: Email address required!

6ES7658-3BX78-2YB5

6ES7658-3BX78-2YH5

SIMATIC PDM Routing V9.2

For plant-wide navigation to field devices

6 languages (English, German, French, Italian, Spanish, Chinese), software class A, runs with Windows 10 Professional 64-bit, Windows 10 Enterprise 2019 LTSC 64-bit, for operation within the product family SIMATIC PCS 7 the specifications there take precedence, (see SIMATIC PDM V9.2 Readme for the latest information), floating license for 1 user

Without SIMATIC PCS 7/SIMATIC PDM Software Media Package

- Goods delivery
License key on USB flash drive and Certificate of License
- Online delivery
License key download, online Certificate of License
Note: Email address required!

6ES7658-3CX78-2YB5

6ES7658-3CX78-2YH5

SIMATIC PDM Server V9.2

For activating the server functionality

6 languages (English, German, French, Italian, Spanish, Chinese), software class A, runs with Windows 10 Professional 64-bit, Windows 10 Enterprise 2019 LTSC 64-bit, for operation within the product family SIMATIC PCS 7 the specifications there take precedence, (see SIMATIC PDM V9.2 Readme for the latest information), single license for 1 installation

Without SIMATIC PCS 7/SIMATIC PDM Software Media Package

- Goods delivery
License key on USB flash drive, Certificate of License
- Online delivery
License key download and online Certificate of License
Note: Email address required!

6ES7658-3TX78-2YB5

6ES7658-3TX78-2YH5

SIMATIC PDM Communication FOUNDATION Fieldbus V9.2

For communication with field devices on FOUNDATION Fieldbus H1

6 languages (English, German, French, Italian, Spanish, Chinese), software class A, runs with Windows 10 Professional 64-bit, Windows 10 Enterprise 2019 LTSC 64-bit, for operation within the product family SIMATIC PCS 7 the specifications there take precedence, (see SIMATIC PDM V9.2 Readme for the latest information), floating license for 1 user

Without SIMATIC PCS 7/SIMATIC PDM Software Media Package

- Goods delivery
License key on USB flash drive and Certificate of License
- Online delivery
License key download and online Certificate of License
Note: Email address required!

6ES7658-3QX78-2YB5

6ES7658-3QX78-2YH5

SIMATIC PDM HART Server V9.2

For using HART multiplexers as well as for configuration of WirelessHART field devices

6 languages (English, German, French, Italian, Spanish, Chinese), software class A, runs with Windows 10 Professional 64-bit, Windows 10 Enterprise 2019 LTSC 64-bit, for operation within the product family SIMATIC PCS 7 the specifications there take precedence, (see SIMATIC PDM V9.2 Readme for the latest information), floating license for 1 user

Without SIMATIC PCS 7/SIMATIC PDM Software Media Package

- Goods delivery
License key on USB flash drive and Certificate of License
- Online delivery
License key download and online Certificate of License
Note: Email address required!

6ES7658-3EX78-2YB5

6ES7658-3EX78-2YH5

Ordering data	Article No.	Technical specifications								
<p>SIMATIC PDM Command Interface V9.2</p> <p>Use of remote control of SIMATIC PDM with 1 x SIMATIC PDM 1 Client</p> <p>Note: Special conditions of purchase and supply</p> <ul style="list-style-type: none"> Goods delivery (without SIMATIC PCS 7/SIMATIC PDM Software Media Package) License key on USB flash drive and Certificate of License 	6ES7658-3SX78-2YB5	<p>SIMATIC PDM V9.2</p> <table border="1"> <tr> <td data-bbox="810 325 1129 353">Hardware</td> <td data-bbox="1136 325 1458 391"> <ul style="list-style-type: none"> PG/PC/notebook with processor corresponding to operating system requirements </td> </tr> <tr> <td data-bbox="810 400 1129 427">Operating system (alternatives)</td> <td data-bbox="1136 400 1458 487"> <ul style="list-style-type: none"> Windows 10 Professional Windows 10 Enterprise 2019 LTSC When integrated, specifications for SIMATIC PCS 7 take precedence </td> </tr> <tr> <td data-bbox="810 495 1129 523">Integration in STEP 7/PCS 7</td> <td data-bbox="1136 495 1458 583"> <ul style="list-style-type: none"> SIMATIC PCS 7 V8.1/V8.2 (without Communication FOUNDATION Fieldbus) SIMATIC PCS 7 V9.x </td> </tr> <tr> <td data-bbox="810 591 1129 619">SIMATIC PDM Client</td> <td data-bbox="1136 591 1458 636"> <ul style="list-style-type: none"> Microsoft Internet Explorer 10 or 11 Google Chrome </td> </tr> </table>	Hardware	<ul style="list-style-type: none"> PG/PC/notebook with processor corresponding to operating system requirements 	Operating system (alternatives)	<ul style="list-style-type: none"> Windows 10 Professional Windows 10 Enterprise 2019 LTSC When integrated, specifications for SIMATIC PCS 7 take precedence 	Integration in STEP 7/PCS 7	<ul style="list-style-type: none"> SIMATIC PCS 7 V8.1/V8.2 (without Communication FOUNDATION Fieldbus) SIMATIC PCS 7 V9.x 	SIMATIC PDM Client	<ul style="list-style-type: none"> Microsoft Internet Explorer 10 or 11 Google Chrome
Hardware	<ul style="list-style-type: none"> PG/PC/notebook with processor corresponding to operating system requirements 									
Operating system (alternatives)	<ul style="list-style-type: none"> Windows 10 Professional Windows 10 Enterprise 2019 LTSC When integrated, specifications for SIMATIC PCS 7 take precedence 									
Integration in STEP 7/PCS 7	<ul style="list-style-type: none"> SIMATIC PCS 7 V8.1/V8.2 (without Communication FOUNDATION Fieldbus) SIMATIC PCS 7 V9.x 									
SIMATIC PDM Client	<ul style="list-style-type: none"> Microsoft Internet Explorer 10 or 11 Google Chrome 									
<p>SIMATIC PDM 1 Client</p> <p>Cumulative client license for SIMATIC PDM configurations with SIMATIC PDM Server, software class A, single license for 1 installation</p> <ul style="list-style-type: none"> Goods delivery License key on USB flash drive and Certificate of License Online delivery License key download and online Certificate of License Note: Email address required! 	<p>6ES7658-3UA00-2YB5</p> <p>6ES7658-3UA00-2YH5</p>	<p>More information</p>								
<p>SIMATIC PDM TAGs</p> <p>TAG licenses for expanding the available TAG volume, cumulative, software class A, floating license for 1 user</p> <ul style="list-style-type: none"> Goods delivery License key on USB flash drive and Certificate of License <ul style="list-style-type: none"> 10 TAGs 100 TAGs 1 000 TAGs Online delivery License key download and online Certificate of License Note: Email address required! <ul style="list-style-type: none"> 10 TAGs 100 TAGs 1 000 TAGs 	<p>6ES7658-3XC00-2YB5</p> <p>6ES7658-3XD00-2YB5</p> <p>6ES7658-3XE00-2YB5</p> <p>6ES7658-3XC00-2YH5</p> <p>6ES7658-3XD00-2YH5</p> <p>6ES7658-3XE00-2YH5</p>	<p>Update/Upgrade</p> <p>Existing installations based on SIMATIC PDM V8.x/V9.0 (including SP in each case) can be upgraded straight to V9.2 with upgrade packages.</p> <p>Projects with SIMATIC PDM V7.0 can only be upgraded to version 9.2 by first upgrading to version 8.0. Two upgrade packages are offered for SIMATIC PDM V8.x/V9.0:</p> <ul style="list-style-type: none"> SIMATIC PDM Upgrade Package Basic¹⁾ (with/without SIMATIC PDM HART Server option in each case) for configurations based on: <ul style="list-style-type: none"> SIMATIC PDM Basic SIMATIC PDM Service SIMATIC PDM S7 SIMATIC PDM PCS 7 SIMATIC PDM Upgrade Package Complete¹⁾ for configurations based on: <ul style="list-style-type: none"> SIMATIC PDM PCS 7 Server SIMATIC PDM PCS 7-FF <p>¹⁾ Optional product components for SIMATIC PDM such as PDM Extended, PDM Integration in STEP 7/PCS 7, PDM Routing, PDM Server and PDM Communication FOUNDATION Fieldbus are each included in a product package listed in the SIMATIC PDM Upgrade Package Basic or SIMATIC PDM Upgrade Package Complete and are implicitly authorized to be updated via the corresponding license. The SIMATIC PDM Upgrade Package Complete is required for use of the product components PDM Server or PDM Communication FOUNDATION Fieldbus.</p>								
<p>SIMATIC PDM Software Media Package</p>		<p>You can find more information in the section "Update/Upgrade Packages" under "Updates/Upgrades Asynchronous to the PCS 7 Version" - "Upgrades SIMATIC PDM".</p>								
<p>SIMATIC PDM Software Media Package V9.2</p> <p>Installation software without license, 6 languages (English, German, French, Italian, Spanish, Chinese), software class A, runs with Windows 10 Professional 64-bit, Windows 10 Enterprise 2019 LTSC 64-bit, for operation within the product family SIMATIC PCS 7 the specifications there take precedence, (see SIMATIC PDM V9.2 Readme for the latest information)</p> <p>Without SIMATIC PCS 7 Software Media Package</p> <p>Note: Can only be used in conjunction with a valid license or in demo mode!</p> <ul style="list-style-type: none"> Goods delivery SIMATIC PDM and device library software on DVD Online delivery SIMATIC PDM and device library software download Note: Email address required! 	<p>6ES7658-3GX78-0YT8</p> <p>6ES7658-3GX78-0YG8</p>									

SIMATIC PCS 7 system software

Plant Device Management

SIMATIC PCS 7 Maintenance Station

Overview

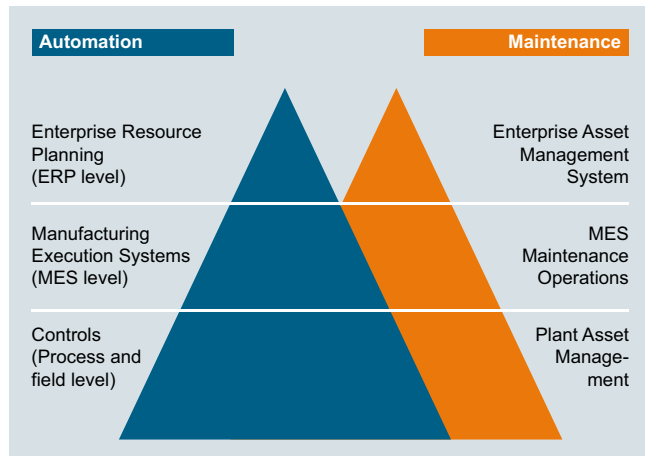

The Maintenance Station is specialized for plant asset management (also known as plant-floor asset management), i.e. the management of company assets that are used as fixed assets for production. Its tasks include efficient administration and management of equipment in technological systems, in particular the I&C equipment, with the objective of maintaining and increasing the value.

The following maintenance strategies are used for this purpose:

- **Corrective maintenance**
Response to pending error and diagnostic messages
 - Failures are risked or minimized by redundant configurations
 - Maintenance in the form of repair or replacement
- **Preventive maintenance**
Preventive diagnostics and maintenance
 - Initiation of appropriate maintenance measures before a fault actually occurs
 - Maintenance in the form of time-dependent or status-dependent maintenance (depending on degree of wear)
- **Predictive maintenance**
Predictive diagnostics for timely detection of potential problems and determination of the remaining service life

Using the Maintenance Station, the maintenance engineer can check the hardware of the automation system, evaluate its diagnostic messages and information and derive maintenance measures from them. He or she is thus in a position to plan, control and document the entire maintenance cycle - starting with the arrival of a diagnostics message, continuing with the evaluation of detailed diagnostics information and the planning, initiation and tracking of maintenance measures, all the way to their completion.

SIMATIC PCS 7 Maintenance Station

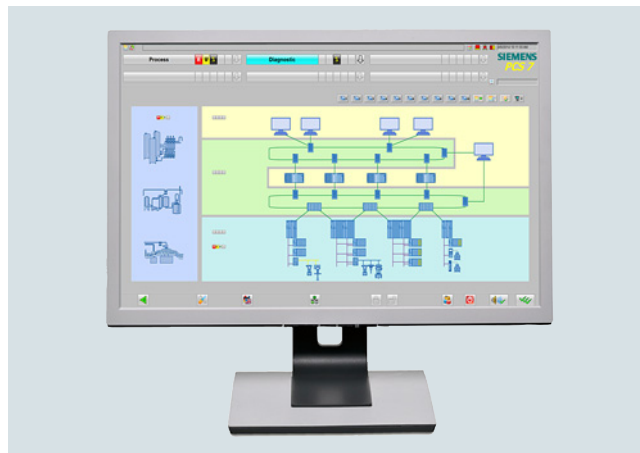

The SIMATIC PCS 7 Maintenance Station makes additional hardware or software components for plant asset management superfluous. Fully integrated in SIMATIC PCS 7, it supplements the process control system with a valuable instrument for minimizing the total cost of ownership over the complete life cycle of the plant.

Parallel to process control, the SIMATIC PCS 7 Maintenance Station provides consistent maintenance information and functions for the system components of the plant (assets):

- The plant operator receives all process-relevant information via the operator system, as well as an overview of the diagnostics status of the process control system.
- The maintenance engineer checks the hardware of the automation system using the SIMATIC PCS 7 Maintenance Station, and processes its diagnostic messages and maintenance requests.

The SIMATIC PCS 7 Maintenance Station provides maintenance and service personnel access to:

- Components of the process control system, e.g. intelligent field devices and I/O modules, fieldbuses, controllers, network components and plant buses as well as Single Stations, Servers and Clients
- Assets that do not directly belong to the process control system, such as pumps, motors, centrifuges, heat exchangers (mechanical assets) or control loops. They are represented by proxy objects in which the diagnostics rules are stored.

It is therefore no longer the case that maintenance functions and information are only available in a separate level independent of the production process.

Plant operators and service personnel are thus able to constantly act the following, for example:

- Service requests
- Service approvals
- Placing an asset in "In Service" status
- Information regarding a completed service measure

Design



Architecture

The SIMATIC PCS 7 Maintenance Station uses hardware and software components of the engineering system (ES) and operator system (OS) for asset management. Depending on the project-specific SIMATIC PCS 7 architecture, it can be implemented on the basis of a SIMATIC PCS 7 BOX (PCS 7 BOX RTX ES/OS system or PCS 7 BOX ES/OS system), a SIMATIC PCS 7 ES single station, or a client/server combination.

As a result of the close interlacing, ES, OS, and asset management functions run on common hardware. Such a multi-functional station cannot only be used for asset management, but also for system engineering or HMI.

The following table shows possible hardware/software configurations of the SIMATIC PCS 7 Maintenance Station (MS).

SIMATIC PCS 7 Maintenance Station as	Single-user system	Single-user system	Multi-user system (client-server combination)		
			Required SIMATIC PCS 7 hardware/software	PCS 7 BOX	PCS 7 ES Single Station
Basic hardware					
SIMATIC PCS 7 BOX RTX ES/OS system or SIMATIC PCS 7 BOX ES/OS system	●	–	–	–	–
SIMATIC PCS 7 Industrial Workstation for ES/OS single system	–	●	●	–	●(Single Station)
SIMATIC PCS 7 Industrial Workstation for OS server	–	–	–	●	●(Server)
Required SIMATIC PCS 7 software corresponding to operating system of basic hardware (without taking into account the quantity frameworks)					
SIMATIC PCS 7 Engineering Software AS/OS	–	●	●	–	●
Optional ¹⁾ ; SIMATIC PDM PCS 7 server ²⁾ ; optionally also SIMATIC PDM-FF ³⁾	●	●	–	–	●
SIMATIC PCS 7 OS Software Server	–	–	–	●	–
SIMATIC PCS 7 OS Software Client	–	–	●	–	–
SIMATIC PCS 7 Maintenance Station Engineering	●	●	●	–	●
SIMATIC PCS 7 Maintenance Station Runtime (basic package and additional asset TAGs)	●	●	–	●	–

1) Only when you use intelligent field devices or the AssetMon functionality

2) Allows SIMATIC PDM to be started on every MS client

3) SIMATIC PDM-FF required for plants with FOUNDATION Fieldbus H1

The MS Server can even be operated as a redundant pair of servers. The redundant MS servers must be configured like redundant OS servers and expanded by the SIMATIC PCS 7 Maintenance Station Runtime functionality.

The SIMATIC PCS 7 Maintenance Station Runtime basic package already contains 100 asset TAGs. These can be expanded by cumulative SIMATIC PCS 7 Maintenance Station Runtime licenses for 100 or 1 000 asset TAGs (Count Relevant Licenses).

The signaling system, user interface, picture hierarchy and operator prompting are based on the HMI philosophy of the operator system. The diagnostics data of all assets are displayed on uniform faceplates whose contents depend on the intelligence of the respective component. This means that working with the SIMATIC PCS 7 Maintenance Station is simple and intuitive – a time-consuming training period is not required.

SIMATIC PCS 7 system software

Plant Device Management

SIMATIC PCS 7 Maintenance Station

Design (continued)

The SIMATIC PCS 7 Maintenance Station uses the optional product package SIMATIC PDM PCS 7 Server for parameter assignment and diagnostics of the devices integrated via an Electronic Device Description (EDD). The optional product component SIMATIC PDM-FF is required for plants with FOUNDATION Fieldbus H1.

For editing the devices, the user receives the functional rights corresponding to their role following identification. User management and access control for the SIMATIC PCS 7 Maintenance Station is handled by SIMATIC Logon integrated in SIMATIC PCS 7.

SIMATIC PDM supplies comprehensive device information for display and further processing on the maintenance station and can be called from any SIMATIC PCS 7 Maintenance Station Client (MS Client). The display of diagnostics displays structured according to the plant hierarchy with the operating states of the SIMATIC PCS 7 components is possible both on purely MS clients and combined MS/OS clients. The faceplates of these stations can also display the enhanced diagnostics information determined by SIMATIC PDM. A device-specific call of SIMATIC PDM is also possible. However, enhanced online diagnostics functions in conjunction with HW Config can only be called on stations that are both an MS client and engineering station for SIMATIC PCS 7 at the same time.

Configuration

The SIMATIC PCS 7 Maintenance Station is based on the hardware and software project of the application which is generated during the standard configuration with the SIMATIC PCS 7 engineering system. With system support, all data relevant to the plant asset management are derived from the project data of the application, and the diagnostics screens are also generated, simply by pressing a button. The procedure is simple, and requires no additional configuration work:

- Generation of the hardware and software project of the application
- Parameter settings for optional functionalities
- System-supported generation of the diagnostics screens with all components present in the project, including the picture hierarchy based on the project's hardware structure
- Compilation of the configuration data, and downloading to the operator station and Maintenance Station with subsequent test and commissioning phase

The names of imported pictures, icons, etc. can be permanently changed for further use in the maintenance project.

Conformity to international standards, specifications, and recommendations

Plant asset management with the SIMATIC PCS 7 Maintenance Station conforms to international standards, specifications, and recommendations. It is based on the NAMUR requirements (process control standards committee in the chemical and pharmaceutical industries) defined for systems for plant asset management and for status messages from field devices:

- NAMUR recommendation NE129 (requirements for systems for plant asset management)
- NAMUR recommendation NE 105 (requirements for the integration of fieldbus devices in engineering tools)
- NAMUR recommendation NE107 (status messages from field devices "Device failure", "Maintenance requirements", "Function check")

In addition, it also observes IEC 61804-2 for describing devices by means of the Electronic Device Description Language (EDDL) and specifications made by the PROFIBUS & PROFINET International (PI) organization, e.g.:

- PROFIBUS Profile Guidelines Identification & Maintenance Functions
- PROFIBUS PA Profile for Process Control Devices

Function

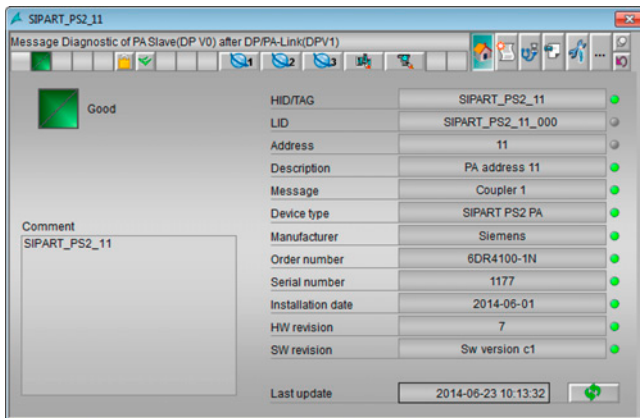

Diagnostics message of a component in the "Identity" faceplate view

The SIMATIC PCS 7 Maintenance Station provides maintenance engineers with comprehensive maintenance information on the system components (assets) of the plant. Starting from the overview display, maintenance engineers can navigate to the diagnostics displays of the subordinate hardware levels to obtain information on the diagnostics status of individual plant areas or components. If a fault is signaled in the overview display, the "Loop in alarm" function permits rapid switching to the diagnostics faceplate of the associated component.

The scope of information available depends on the individual possibilities of the asset, and is filtered according to the user's area of responsibility.

The following information is available, for example:

- Display of diagnostics status detected by the system
- Information on the component, such as process tag name, manufacturer or serial number
- Display of diagnostics messages of an individual component
- Visualization of the type and current state of the initiated maintenance measure

Information on mechanical assets

For mechanical assets without self-diagnostics (pumps, motors, etc.), the AssetMon function block can determine inadmissible operating states from various measured values and their deviations from a defined normal status. These are displayed as maintenance alarms on the SIMATIC PCS 7 Maintenance Station. AssetMon is able to process up to 3 analog values and up to 16 binary values.

In addition, AssetMon is suitable for implementation of:

- Individual diagnostics structures
- Project-specific diagnostics rules
- Condition monitoring functions

Enhanced information for assets according to IEC 61804-2

Further information can be called for assets described by the electronic device description (EDD) according to IEC 61804-2. This information is automatically read out of the components and made available by SIMATIC PDM in the background.

- Device type information (electronic rating plate)
- Detailed diagnostics information
 - Device-specific information from the vendor
 - Information on fault diagnostics and troubleshooting
 - Additional documentation

- Results of internal condition monitoring functions
- Status information (e.g. local configuration changes)
- Information on changes (audit trail report)
- Parameter information

Visualization of the maintenance information

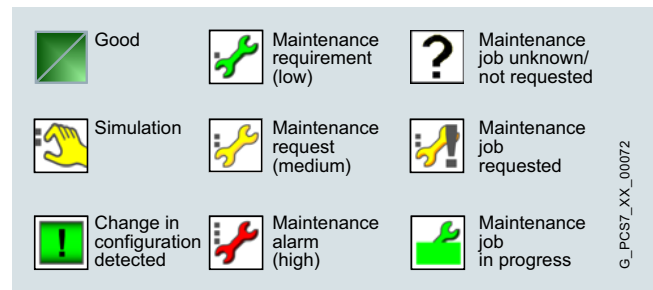

Uniform symbols for visualization of the maintenance status as well as operator prompting

The hierarchical structuring of information and the uniform symbols support the overview, facilitate orientation, and permit the maintenance engineer to rapidly access detailed information starting from the plant overview.

The symbol set defined for the plant asset management contains symbols which identify the diagnostic status of the devices/components, the relevance of the maintenance request, and the status of the maintenance measure.

Group displays in the plant overview visualize the diagnostics status of the subordinate structures/components according to a type of traffic light with red, yellow or green.

In line with their significance, the components described with a device description package in SIMATIC PDM can be marked as follows and also directly filtered using these features:

- Normal
- Important
- Safety Instrumented Function (SIF)
- Device checked
- Project-specific write protection

Diagnostics screens display the status of components and subordinate devices/components through standardized symbols with the following elements:

- Bitmap of component
- Tag identification of component
- Maintenance state display
- Group display for diagnostics status of subordinate components

Clicking an element in the symbol display either opens the subordinate hierarchy level or a component faceplate. The component faceplate offers various views of the associated component with additional device-specific information, e.g. an identification, message or maintenance view.

SIMATIC PCS 7 system software

Plant Device Management

SIMATIC PCS 7 Maintenance Station

Ordering data

Article No.

Article No.

SIMATIC PCS 7 Maintenance Station Runtime Basic Package V9.1

including SNMP OPC server license and 100 asset TAGs

6 languages (English, German, French, Italian, Spanish, Chinese), software class A

Runs with the following operating systems (see SIMATIC PCS 7 V9.1 Readme for the latest information):

- Windows 10 Enterprise 2015 LTSC
- Windows 10 Enterprise 2019 LTSC
- Windows Server 2016 Standard Edition
- Windows Server 2016 Datacenter Edition, Standard Edition

Single license for 1 installation, without SIMATIC PCS 7 Software Media Package

- Goods delivery
License key on USB flash drive, Certificate of License
- Online delivery
License key download, online Certificate of License
Note: Email address required!

6ES7658-7GB68-0YB0

6ES7658-7GB68-0YH0

SIMATIC PCS 7 Maintenance Station Runtime Asset TAGs

for adding asset TAGs, cumulative

Language-neutral, software class A, single license for 1 installation

Without SIMATIC PCS 7 Software Media Package

- Goods delivery
License key on USB flash drive, Certificate of License
- 100 asset TAGs
- 1 000 asset TAGs
- Online delivery
License key download, online Certificate of License
Note: Email address required!

6ES7658-7GB00-2YB0

6ES7658-7GC00-2YB0

6ES7658-7GB00-2YH0

6ES7658-7GC00-2YH0

Maintenance Station Engineering

SIMATIC PCS 7 Maintenance Station Engineering V9.1

6 languages (English, German, French, Italian, Spanish, Chinese), software class A

Runs with the following operating systems (see SIMATIC PCS 7 V9.1 Readme for the latest information):

- Windows 10 Enterprise 2015 LTSC
- Windows 10 Enterprise 2019 LTSC
- Windows Server 2016 Standard Edition
- Windows Server 2016 Datacenter Edition, Standard Edition

Floating license for 1 user, without SIMATIC PCS 7 Software Media Package

- Goods delivery
License key on USB flash drive, Certificate of License
- Online delivery
License key download, online Certificate of License
Note: Email address required!

6ES7658-7GX68-0YB5

6ES7658-7GX68-0YH5

Asset TAGs

Asset TAGs license the number of asset objects that are monitored with the SIMATIC PCS 7 Maintenance Station. An asset object represents individual hardware components within a SIMATIC PCS 7 project, e.g.

- Measuring devices monitored per EDD, positioners, switching devices, or remote I/O stations
- Basic devices or Ethernet components monitored per OPC coupling in the Maintenance Station

The asset TAGs of the SIMATIC PCS 7 Maintenance Station Runtime licenses (sets of 100 and 1 000) are cumulative (Count Relevant Licenses).

Overview

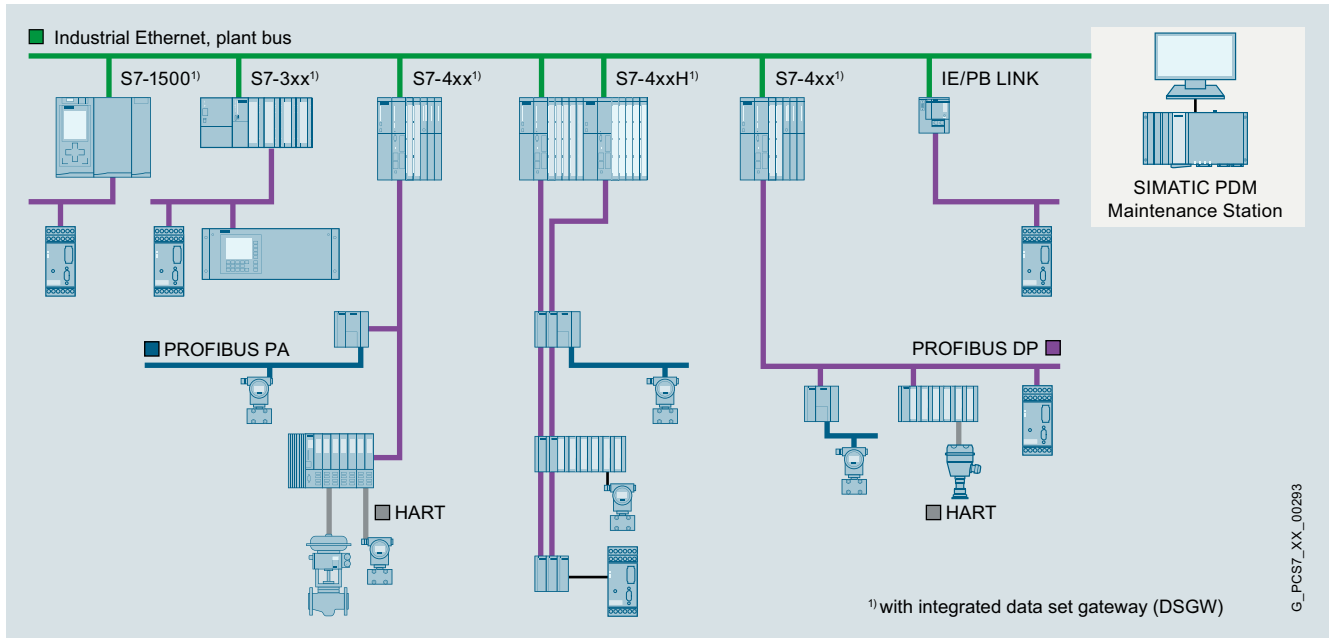

Integration of the system-independent SIMATIC PDM Maintenance Station in SIMATIC and SIMATIC PCS 7 to connect to the plant bus

In contrast to SIMATIC PCS 7 Maintenance Station, which is seamlessly integrated into the SIMATIC PCS 7 process control system, SIMATIC PDM Maintenance Station operates on separate hardware, independent of the automation projects and the employed automation systems (controllers). It integrates field devices and components via their Electronic Device Description and uses the communication paths of SIMATIC PDM to exchange information.

Note:

The SIMATIC PDM Maintenance Station is based on software components from SIMATIC PCS 7.

The device management and integration functions are based on SIMATIC PDM.

Application

The SIMATIC PDM Maintenance Station is suitable for all projects which use communication modes supported by SIMATIC PDM as well as field devices described by an Electronic Device Description (EDD/FDI).

Field devices and field components which were integrated into SIMATIC PDM using an EDD/FDI device description can be monitored and evaluated.

It is also easy to monitor and diagnose HART field devices and field components connected to HART multiplexers or communicating via Wireless HART on site.

The SIMATIC PDM Maintenance Station is especially suited to the following tasks:

- Implementation of small to medium-sized service projects. Up to 500/1 000 devices can be managed per maintenance station.
- Greater quantities can be attained by using multiple SIMATIC PDM Maintenance Stations.
- Configuration of unit-granular maintenance stations or stand-alone solutions.
- Formation of up to three field device groups for cyclic data export functions.
- Maintenance station retrofitting in SIMATIC S7/SIMATIC PCS 7 projects independent of the project version.
- Implementation of maintenance stations in SIMATIC S7/SIMATIC PCS 7 projects without "Plant-wide data record routing" functionality.
- Separate technological projects and service projects.
- Implementation of maintenance stations in projects without SIMATIC S7/SIMATIC PCS 7 automation systems (controllers).

SIMATIC PCS 7 system software

Plant Device Management

SIMATIC PDM Maintenance Station

Design



SIMATIC PDM Maintenance Station is based on the hardware of the Microbox SIMATIC IPC427E, equipped with a 240 GB SSD as a data storage medium. Due to its exceptional physical properties, it is suited for 24-hour continuous operation at temperatures from 0 to 50 °C.

Expansions/interfaces

The SIMATIC PDM Maintenance Station has:

- 4 USB interfaces (3.0, high current)
- 2 COM interfaces (RS 232/RS 485/RS 422, selectable)
- 2 DisplayPort graphics interfaces
- 3 Ethernet interfaces 10/100/1 000 Mbps (RJ45)

It is supplied without input/output devices. In addition to mouse and keyboard, two other input/output devices can be externally connected via the provided USB ports, e.g. an optical drive (DVD-ROM/DVD±RW) or smart card reader USB.

Pre-installed software

- Windows 10 Enterprise 2019 LTSC

Included software

- SIMATIC PCS 7 V9.1 Media Package for SW Package Installation
- SIMATIC PDM Device Description Library 1#2020

Function

The functionality of the SIMATIC PDM Maintenance Station is largely based on the SIMATIC PCS 7 Maintenance Station and the SIMATIC PDM Process Device Manager for stand-alone operation. The operator interfaces are comparable with those of the SIMATIC PCS 7 Maintenance Station configured as single station. SIMATIC PDM integrates the intelligent field devices (sensors/actuators) and field components (remote I/Os, multiplexers, control room devices, compact controllers, etc.) via their Electronic Device Description (EDD).

For communication with field devices/components, SIMATIC PDM Maintenance Station uses the SIMATIC PDM communication paths over the following communication interfaces:

- Industrial Ethernet
- PROFIBUS DP
- PROFIBUS PA
- HART on PROFIBUS
- HART multiplexer
- WirelessHART
- MODBUS (on request)

The diagnostic information is determined over a cyclic polling algorithm. Polling can be parameterized for every single field device in the SIMATIC PDM Maintenance Station in cycles of 10 min/1 h/12 h/1 d.

Ordering data	Article No.	Article No.
<p>SIMATIC PDM Maintenance Station Complete Package Single-user Station V4.0</p> <p>Hardware and software for engineering and operation; IPC 427E with MS W10 LTSC 2019 operating system; with virtual controller; with SIMATIC PCS 7 Media Package; SIMATIC PDM, SIMATIC PDM Device Library 1#2020</p> <p>5 languages (English, German, French, Italian, Spanish); software class A; single license for 1 installation;</p> <p>License frame for up to 1 000 objects (OS RT PO, MS RT PO)</p> <p>104 PDM TAGs</p> <ul style="list-style-type: none"> • Goods delivery License key on USB flash drive, Certificate of License Bundled with 1 x SIMATIC PCS 7 Software Media Package per order item 	6ES7650-0RJ04-0YX0	<p>SIMATIC PDM Maintenance Station Software Update Service (SUS)</p> <p>Subscription for 1 year with automatic extension Requirement: current software version Software Media Package SIMATIC PCS 7 Software Media Package SIMATIC PDM</p> <ul style="list-style-type: none"> • Goods delivery License key on USB flash drive and Certificate of License <p>6ES7658-3XX03-0YL8</p>
<p>SIMATIC PDM Maintenance Station Software Single-user Station V4.0</p> <p>Software for engineering and operation; with virtual controller; with SIMATIC PCS 7 Media Package; SIMATIC PDM, SIMATIC PDM Device Library 1#2020</p> <p>5 languages (English, German, French, Italian, Spanish) Software class A, single license for 1 installation With SIMATIC PCS 7 Software Media Package</p> <p>License frame for up to 1 000 objects (OS RT PO, MS RT PO)</p> <p>104 PDM TAGs</p> <ul style="list-style-type: none"> • Goods delivery License key on USB flash drive, Certificate of License Bundled with 1 x SIMATIC PCS 7 Software Media Package per order item 	6ES7651-5GX04-0YA5	<p>Additional and expansion components</p> <p>SIMATIC PDM TAGs TAG licenses for expanding the available TAG volume, cumulative, software class A, floating license for 1 user</p> <ul style="list-style-type: none"> • Goods delivery License key on USB flash drive and Certificate of License <ul style="list-style-type: none"> - 10 TAGs 6ES7658-3XC00-2YB5 - 100 TAGs 6ES7658-3XD00-2YB5 - 1 000 TAGs 6ES7658-3XE00-2YB5 • Online delivery License key download and online Certificate of License Note: Email address required! <ul style="list-style-type: none"> - 10 TAGs 6ES7658-3XC00-2YH5 - 100 TAGs 6ES7658-3XD00-2YH5 - 1 000 TAGs 6ES7658-3XE00-2YH5
<p>SIMATIC PDM Maintenance Station Upgrade Package V3.0 ⇒ V4.0</p> <p>Software upgrade for engineering and operation; IPC 427E with MS W10 LTSC 2019 operating system; with virtual controller; with SIMATIC PCS 7 Media Package; SIMATIC PDM, SIMATIC PDM Device Library 1#2020</p> <p>5 languages (English, German, French, Italian, Spanish); software class A; single license for 1 installation; with SIMATIC PCS 7 Software Media Package</p> <p>16GB HSP upgrade</p> <p>License VC dongle VC V10.2</p> <ul style="list-style-type: none"> • Goods delivery License key on USB flash drive, Certificate of License Bundled with 1 x SIMATIC PCS 7 Software Media Package per order item 	6ES7651-5GX04-0YE5	<p>Keyboard/mouse</p> <p>USB keyboard TKL-105 Color: black</p> <ul style="list-style-type: none"> • Keyboard layout, German 6AV6881-0AU14-0AA0 • Keyboard layout, US International 6AV6881-0AU14-1AA0 <p>SIMATIC HMI USB mouse 6AV2181-8AT00-0AX0 Optical mouse with scroll wheel and USB connection, color anthracite</p>

SIMATIC PCS 7 system software

Plant Device Management

SIMATIC Plant Asset Maintenance Station

Overview

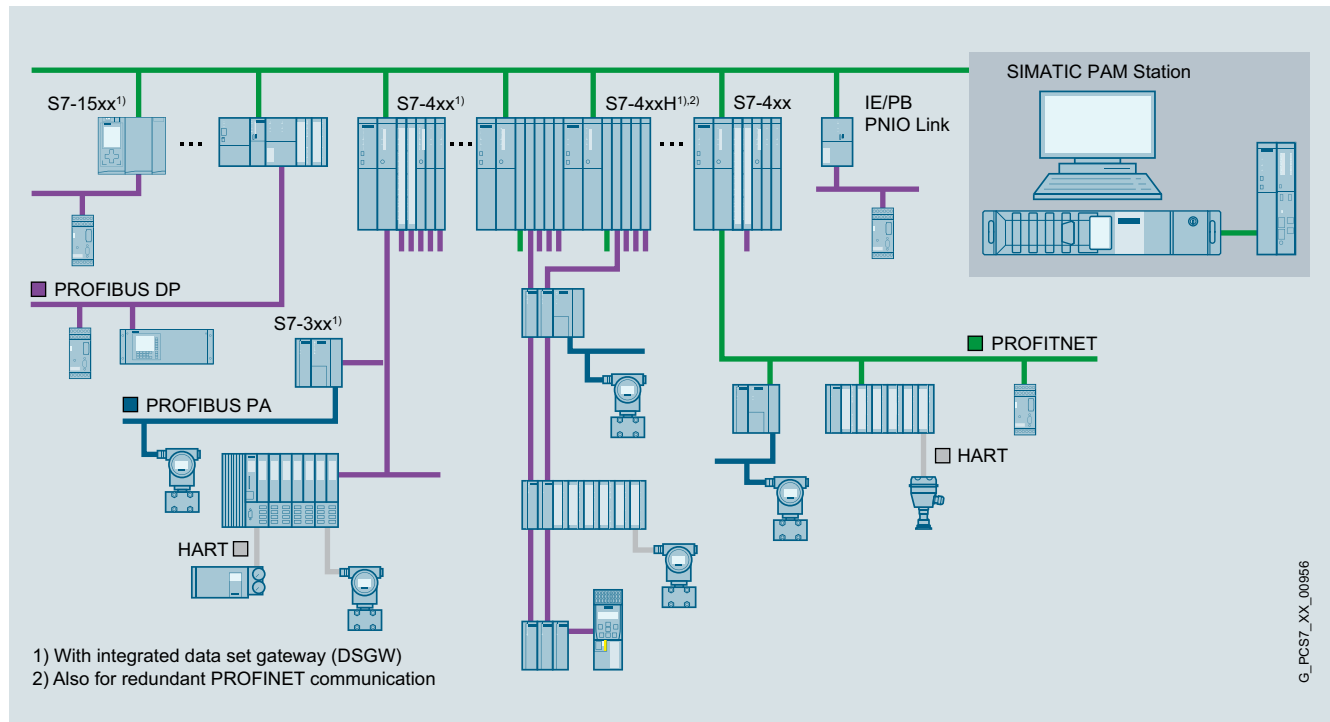

SIMATIC Plant Asset Maintenance (PAM) Station

In contrast to SIMATIC PCS 7 Maintenance Station, which is seamlessly integrated into the SIMATIC PCS 7 process control system, the SIMATIC Plant Asset Maintenance (PAM) Station operates on separate hardware, independent of the automation projects and the employed automation systems (controllers). It integrates field devices and components via its Electronic Device Description and can read and process data and diagnostic information directly from the SIMATIC controllers. To exchange information, the station uses the SIMATIC PDM communication paths and connections to the SIMATIC controllers configured on the SIMATIC PAM station.

Note:

- The SIMATIC PAM station is based on SIMATIC PCS 7 software components.
- The device management and integration functions are based on SIMATIC PDM.

Application

The SIMATIC PAM Station, designed for use as a single-station (single station) or as a multi-station (server station), represents an extension of the already proven portfolio of maintenance stations from the SIMATIC PCS 7 product family by a further independent product variant. The SIMATIC PAM station, which can be used as a stand-alone unit, works independently of the automation projects and the automation systems (controllers) used for them. It is primarily designed for the management of maintenance, diagnostic and condition monitoring functions of package units that work with SIMATIC controllers. It offers the possibility of diagnostic acquisition of all packaging unit components, field device management, acquisition and forwarding of parameterization, diagnostic and status data from field devices and monitoring of SIMATIC IPC stations, SCALANCE network components on the plant bus. It combines the mechanisms for diagnosis and communication of EDD/DD/FDI-based field devices via SIMATIC PDM and components described via SNMP profiles with the functions of the SIMATIC PCS 7 Maintenance Station for up to 100 package units.

The SIMATIC PAM station is particularly suitable for the following tasks:

- Implementation of medium to large-sized service projects. Up to 100 SIMATIC controllers with 200 field devices/field stations each can be managed by one maintenance station.
- Monitoring and diagnostics of up to 500 components (SIMATIC IPC or SCALANCE switch) on the plant bus, which are described via an SNMP profile file.
- Higher configuration limits can be achieved using multiple SIMATIC PAM stations.
- Configuration of unit-granular maintenance stations or stand-alone solutions.
- Formation of up to three field device groups for cyclic data export functions.
- Processing and monitoring of up to three analog status values in condition monitoring functions.
- Reading and processing of diagnostic information from the data repository of the package units.
- Maintenance station retrofitting in SIMATIC S7/SIMATIC PCS 7 projects independent of the project version.
- Implementation of maintenance stations in SIMATIC S7/SIMATIC PCS 7 projects without plant-wide data record routing functionality.
- Optionally as single-user or client/server system. Separate technological and service projects.

Design

The SIMATIC PAM Station based on software components of the SIMATIC PCS 7 product family. Installation is performed as a package installation by the SIMATIC PCS 7 Multimedia Package.

The SIMATIC PAM Station was developed and tested for the following hardware:

- SIMATIC IPC 547 or 647 as SIMATIC PAM Operating Station
- SIMATIC AS-Station 410 as SIMATIC PAM signal processing station

The SIMATIC PAM Station contains the following software components:

- Compact/reduced/changed SIMATIC PCS 7 software package, based on the current SIMATIC PCS 7 software version release
- SIMATIC PDM as server application in the variant integrated in SIMATIC PCS 7
- The current EDD/FDI device description library of SIMATIC PDM at the time of delivery

Function

The functionality of the SIMATIC PAM Station is largely based on the SIMATIC PCS 7 Maintenance Station and the SIMATIC PDM Process Device Manager for stand-alone operation. The user interfaces are comparable to those of the SIMATIC PCS 7 Maintenance Station. SIMATIC PDM integrates the intelligent field devices (sensors/actuators) and field components (remote I/Os, multiplexers, control room devices, compact controllers, etc.) via their Electronic Device Description (EDD) or FDI Device Description Package.

For communication with the field devices/components, the SIMATIC PAM station uses the SIMATIC PDM communication paths via the following communication interfaces:

- PROFINET
- PROFIBUS DP
- PROFIBUS PA via PROFIBUS DP
- PROFIBUS PA via PROFINET
- HART on PROFIBUS
- HART on PROFINET
- HART multiplexer
- WirelessHART

The diagnostic information is determined over a cyclic polling algorithm. Polling can be parameterized for each individual field device in the SIMATIC PAM station in cycles of 10 min/1 h/12 h/1 d.

Optionally, additional status values, diagnostic and detailed diagnostic information can be read in cycle times of approx. 1 sec via data blocks configured in the SIMATIC controllers of the package units and used for message generation and processing in condition monitoring functions.

Numerous SIMATIC PCS 7 system functions are available as options in the SIMATIC PAM station.

SIMATIC PCS 7 system software

Plant Device Management

SIMATIC Plant Asset Maintenance Station

Ordering data

Article No.

SIMATIC PAM Station Software Server V2.0 incl. 1000 MS Runtime PO

5 languages (English, German, French, Italian, Spanish)
Software class A, single license for 1 installation
With SIMATIC PCS 7 Software Media Package
License frame for up to 1 000 objects (OS RT PO MS RT PO)

4 PDM TAGs

- Goods delivery
License key on USB flash drive, Certificate of License
Bundled with 1 x SIMATIC PCS 7 Software Media Package per order item
- Online delivery
License key download and online Certificate of License
Combined with SIMATIC PCS 7 Software Media Package (software download and online Certificate of License)
Note: Email address required!

6ES7658-7QC02-0YB0

6ES7658-7QC02-0YH0

SIMATIC PAM Station Software Server ASIA V2.0 incl. 1000 MS Runtime PO

2 languages (English, Chinese);
Software class A, single license for 1 installation
With SIMATIC PCS 7 Software Media Package ASIA
License frame for up to 1 000 objects (OS RT PO MS RT PO)

4 PDM TAGs

- Goods delivery
ASIA license key on USB hardlock and Certificate of License;
Bundled with 1 x SIMATIC PCS 7 Software Media Package ASIA per order item

6ES7658-7QC02-0CB0

SIMATIC PAM Station Software Update Service (SUS)

Subscription for 1 year with automatic extension
Requirement: current software version
Software Media Package
SIMATIC PCS 7
Software Media Package
SIMATIC PDM

- Goods delivery
License key on USB flash drive and Certificate of License

6ES7658-7QC00-0YL8

SIMATIC PAM Station Upgrade Package V1.0 to V2.0

Software Media Package
SIMATIC PCS 7
Software Media Package
SIMATIC PDM

- Goods delivery
License key on USB flash drive and Certificate of License

6ES7658-7QC02-0YE0

Article No.

Additional and expansion components

SIMATIC PCS 7 Maintenance Station Runtime Asset TAGs

OS Runtime License for extending the MS Runtime PO, cumulative, language-independent, software class A, single license for 1 installation without SIMATIC PCS 7 Software Media Package

- Goods delivery
License key on USB flash drive and Certificate of License
- 100 MS RT PO
- 1 000 MS RT PO
- Online delivery
License key download and online Certificate of License
Note: Email address required!
- 100 MS RT PO
- 1 000 MS RT PO

6ES7658-7GB00-2YB0
6ES7658-7GC00-2YB0

6ES7658-7GB00-2YH0
6ES7658-7GC00-2YH0

SIMATIC PDM TAGs

TAG licenses for expanding the available TAG volume, cumulative, software class A, floating license for 1 user:

- Online delivery
License key download and online Certificate of License
- 10 PDM TAG
- 100 PDM TAG
- 1000 PDM TAG
- Online delivery
License key download and online Certificate of License
Note: Email address required!
- 10 TAG
- 100 TAG
- 1000 TAG

6ES7658-3XC00-2YB5
6ES7658-3XD00-2YB5
6ES7658-3XE00-2YB5

6ES7658-3XC00-2YH5
6ES7658-3XD00-2YH5
6ES7658-3XE00-2YH5

Keyboard/mouse

USB keyboard TKL-105

Color: black

- Keyboard layout, German
- Keyboard layout, US International

6AV6881-0AU14-0AA0
6AV6881-0AU14-1AA0

SIMATIC HMI USB mouse

Optical mouse with scroll wheel and USB connection, color anthracite

6AV2181-8AT00-0AX0

Batch automation



8/2
8/4

SIMATIC BATCH
SIMATIC BATCH software

SIMATIC PCS 7 system software

Batch automation

SIMATIC BATCH

Overview

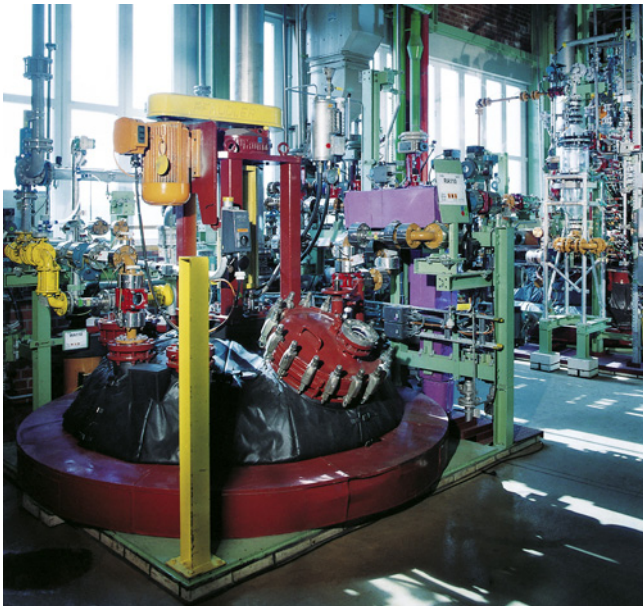

In the process industry, discontinuous processes – so-called batch processes – are of great significance. Permanently shorter product lifecycles as well as the versatility required by consumers are two of the reasons for this.

Product quality that stays the same even in the umpteenth batch, quick response to changed market conditions, traceability for production (FDA compliance), fulfillment of legal standards, as well as the economic and technical necessity to utilize production plants flexibly and optimally – all of this places high demands on plant automation.

The SIMATIC PCS 7 process control system with the SIMATIC BATCH software package offers the right solution for low-cost and effective automation of batch processes.

SIMATIC BATCH is completely integrated in SIMATIC PCS 7, both in the visualization and in the engineering system. Thanks to the modular design and the flexible scaling, it can be used in small test centers as well as in production plants of any size.

Design

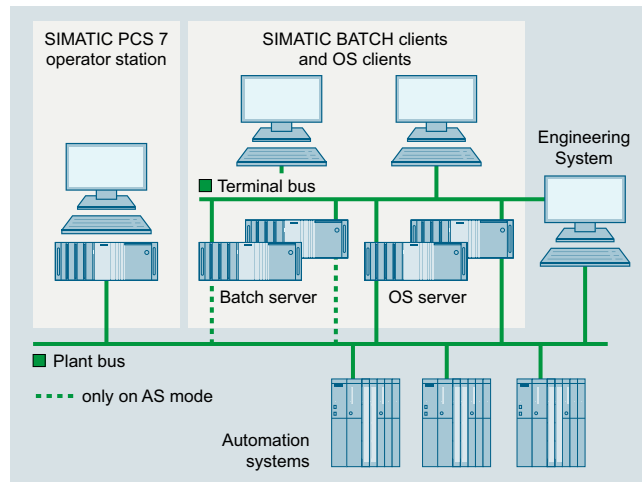

Scalability

SIMATIC BATCH is configured as a single station system or as a client/server system and can be used in plants of any size due to its modular architecture and scalability in cumulative SIMATIC BATCH UNITS (sets of 1, 10 and 50 plant unit instances).

Single-user system for small applications

For small batch applications, SIMATIC BATCH can be installed together with the OS software on a Single Station system.

Client/server configuration

However, a characteristic feature of the automation of batch processes using SIMATIC BATCH is client/server architectures in which one Batch Server and multiple Batch Clients together process a plant project. The Batch Server in such a configuration can also be configured with redundancy in order to increase availability.

SIMATIC BATCH Clients and OS Clients can run on separate or common basic hardware. In addition to the SIMATIC PCS 7 Industrial Workstations, SIMATIC PCS 7 OS Clients 427E/477E are also suitable as Batch Clients.

The Batch Server software, SIMATIC BATCH Basic or SIMATIC BATCH Server, provided for configuration of a Batch Server usually runs on dedicated server hardware (Batch Server). Depending on the load on the Operator System, the OS Server and Batch Server software can also be run on shared server hardware (OS/Batch Server).

The hardware configuration of the Batch Server depends on the SIMATIC BATCH operating mode:

- In **PC mode**, the complete recipe logic is executed in the batch server. If SIMATIC BATCH is only executed in PC mode, the Batch Server does not require a connection to the plant bus. Communication with the automation system is via the Operator System.
- In **AS mode**, the recipe unit logic is executed in the automation system. Mixed operation with PC operating mode is also possible within a batch where recipe units are run on both the Batch Server and on the automation system. In AS mode, the Batch Server requires a connection to the plant bus for communication with the automation system.

Design (continued)**System connection**

Batch Single Station and Batch Server can be connected to the Industrial Ethernet plant bus via a CP 1623/CP 1628 communications module or via a simple FastEthernet network adapter with BCE (suitable for communication with up to 8 automation systems; not redundant systems).

The IE versions of the SIMATIC PCS 7 Workstation for Single Stations and Servers are equipped with a CP 1623 communications module with the SIMATIC NET HARDNET-IE S7 communication software. When using redundant automation systems, the SIMATIC PCS 7 workstation requires SIMATIC NET HARDNET-IE S7-REDCONNECT communication software instead of the SIMATIC NET HARDNET-IE S7 communication software. SIMATIC NET HARDNET-IE S7-REDCONNECT PowerPack can be used to upgrade the communication software. For order data on this, see "Industrial Communication" section, "Industrial Ethernet, System Connection PCS 7 Systems" subsection.

The 10/100/1 000 Mbps Ethernet RJ45 port is already onboard and can be used for connecting to the terminal bus.

Redundancy

SIMATIC BATCH supports Batch Server redundancy. The two Batch Servers in a redundant pair of servers have identical configurations. A separate Ethernet connection via separate network adapters/connectors between these servers is used to optimize the internal communication. This must always be provided as an Ethernet connection. This also applies if SIMATIC BATCH software and SIMATIC PCS 7 OS software are installed together on the redundant pair of servers. The serial RS 232 connection described in the section "OS redundancy" is not possible in this case.

A redundant optical or electrical connection can be used depending on the ambient conditions and the distance between the two Batch Servers, for example up to 100 m per crossover network cable (RJ45 plug). For details, refer to the "High-availability process control systems" manual; for appropriate cable material and further accessories, see Catalog IK PI.

Note:

Licenses for the server, API and UNITS and for SIMATIC BATCH OS Control Web Client must be installed on both servers for the redundant version.

Basic hardware

The modularity and flexibility of SIMATIC BATCH are optimally supported by the hardware available. The basic hardware from the "Industrial Workstation/IPC" section can be used for SIMATIC BATCH. Please note that the operating system and the ES/OS software of the SIMATIC PCS 7 process control system are pre-installed as standard on the SIMATIC PCS 7 Industrial Workstations of version Single Station, Server and Client. If these basic devices are used for SIMATIC BATCH, it is possible to extend the existing SIMATIC PCS 7 installation or restore it for the operating system using the Restore DVD set.

Expansion options

OS/Batch Single Station and Batch client can be optionally expanded for multi-monitor mode with up to 4 monitors. Using multi-monitor mode, the visualization of a plant/unit can be divided among 2 to 4 process monitors per operator station using different views. These plant sections can all be operated using just one keyboard and one mouse.

Note:

Since all messages from SIMATIC BATCH are processed in the message system of the Operator System, the use of a signal module is only recommendable with multi-function OS/Batch stations (Clients, Single Stations).

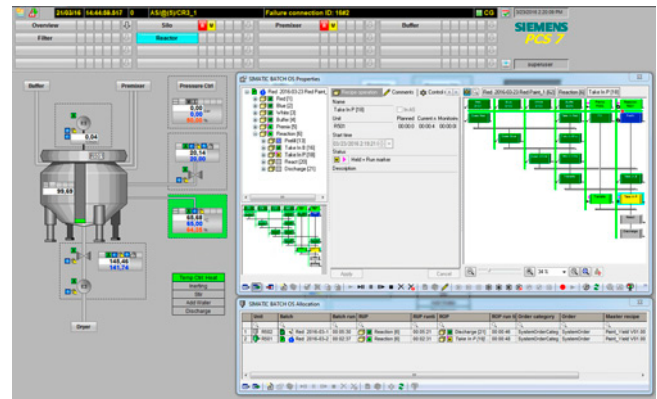
Integration

Process picture with integrated OS Control

Integration in SIMATIC PCS 7

SIMATIC BATCH is completely integrated in SIMATIC PCS 7. The plant data can be configured entirely using the engineering system. The engineering system transfers all data required for creating recipes to the Batch server. It is therefore possible to edit recipes separate from the engineering system. Changes to the configuration which are made in the engineering system are available to the Batch server using an update function (online/offline).

SIMATIC BATCH supports the operation and monitoring of batch processes by means of standard faceplates (faceplates and OS controls integrated in the process picture). With SIMATIC PCS 7 V9.1, operation is also possible using OS controls configured on a Web client.

The SIMATIC Logon integrated in SIMATIC PCS 7 uses SIMATIC BATCH for the following functions:

- Central user administration with access control
- "Electronic Signature" function
This means that actions cannot be performed until enabled by authorized users/user groups.

A smart card reader suitable as a logon device is offered in section "Industrial Workstation/IPC", under "Expansion components, smart card reader".

Communication with the automation systems

Depending on the operating mode, SIMATIC BATCH communicates with the automation systems via the Operator System or directly via S7-DOS.

SFC instances derived from a SFC type template are generally used as the interface to the subordinate automation level. The properties of the SFC type can be defined in a properties dialog, including:

- Control strategies
- Setpoint/actual value
- Instance parameters
- Timers

In addition to the SFC instances, individual unit parameters can be described by parameter steps of the recipe.

SIMATIC PCS 7 system software

Batch automation
SIMATIC BATCH

SIMATIC BATCH software

Overview

The product structure of the SIMATIC BATCH software is optimized for configuration of client-server systems and single station systems. SIMATIC BATCH Basic and SIMATIC BATCH Server are two alternative software products for the server installation and differ in their functional scope.

Additional functions of SIMATIC BATCH Server compared to SIMATIC BATCH Basic are, for example:

- ROP Library
- Separation Procedures/Formulas
- Electronic signature
- MES High Level Synchronization
- Route Control Integration

In exceptional cases, the SIMATIC BATCH client software can also be operated on the Batch server. However, the preferred target system for the SIMATIC BATCH client software is the standalone Batch client.

The SIMATIC BATCH Single Station package is intended for the Batch single station. The SIMATIC BATCH recipe system already integrated in the SIMATIC BATCH Single Station package must be ordered separately for the stations of the client/server system. The SIMATIC BATCH API can be optionally used in both the Batch Single Station and in batch servers.

The SIMATIC BATCH project can be matched quantitatively to the plant size using SIMATIC BATCH UNITS (cumulative quantity options for instances of plant units).

SIMATIC BATCH Server Expansion Pack

With highly complex process cells that can process a high volume of batches, the total amount of main memory required by all batches together can exceed the level of 1.5 GB. No additional batches can be released or started. This can be avoided by additionally installing **Server Expansion Packs**, each of which provides an additional 500 MB of main memory.

Software products/licenses	Batch single station	Batch server	Redundant Batch server pair		Batch client
			Server A	Server B	
Basic software					
SIMATIC BATCH Single Station Package ¹⁾	●	–	–	–	–
SIMATIC BATCH Basic ²⁾⁶⁾	–	●	●	●	–
SIMATIC BATCH Server ²⁾⁶⁾	–	●	●	●	–
SIMATIC BATCH Client ³⁾	–	○	○	○	●
SIMATIC BATCH Recipe System	–	○	○	○	○ ⁴⁾
SIMATIC BATCH API ⁶⁾	○	○	○	○	–
Quantity options: Cumulative objects⁶⁾					
• SIMATIC BATCH UNITS ⁵⁾					
- 1 UNIT	○	○	○	○	–
- 10 UNITS	○	○	○	○	–
- 50 UNITS	○	○	○	○	–
• SIMATIC BATCH OS Control Web Client					
- 1 Web client	○	○	○	○	–
- 5 Web clients	○	○	○	○	–
• Server Expansion Pack					
- 500 MB	○	○	○	○	–

SIMATIC BATCH software products/licenses for Batch single station, Batch server and Batch client

1) SIMATIC BATCH Single Station Package License includes the functionalities Server, Client and Recipe System. However, these cannot be extracted as individual licenses and distributed over multiple computers.

2) Alternative Batch Server Software: SIMATIC BATCH Server with full functionality or SIMATIC BATCH Basic with reduced range of functions.

3) A SIMATIC BATCH Client license is needed for the Batch Control Center (BatchCC) and for the Batch OS Controls. If both BatchCC and the Batch OS Control are being used on a PC, only 1 SIMATIC BATCH Client license has to be installed.

4) A client/server system is required on at least one client.

5) Instances of units; at least one SIMATIC BATCH UNIT license is required per project.

6) In a redundant configuration, the licenses must be installed on both servers.

● Software product/license required

○ Software product/license optional

– Software product/license not required or not available

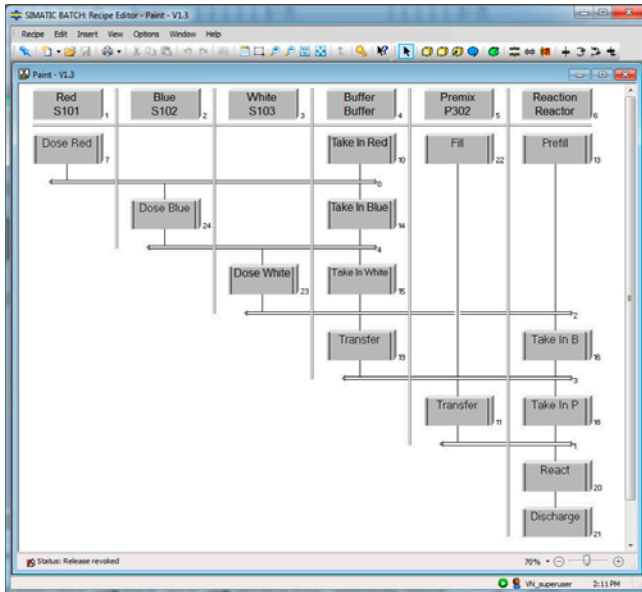
Function**Recipe editor**

The recipe editor is integrated in the SIMATIC BATCH Single Station Package and can be installed as a functional expansion component of the SIMATIC BATCH Recipe System on a batch client and batch server.

It is used for easy, intuitive creation and modification of master recipes and library operations. The basis for recipe creation are the batch objects created from the plant configuration using the SIMATIC PCS 7 Engineering System, e.g. units and equipment phases.

The Batch Recipe Editor can be started individually, but can also be launched from the Batch Control Center (BatchCC). It possesses a GUI, processing functions typical to Microsoft Windows for individual and grouped objects, and a structural syntax check.

The recipe editor offers powerful functions for the following tasks:

- Creation of new master recipes and library operations
- Definition of user interface in the project settings
- Modification of existing master recipes and library operations (changes in structure or parameters)
- Querying the states of recipe objects and process values in transition conditions
- Assignment of route control locations as transfer parameters (source, target, via) to the transport phases, in order to direct products of one batch to other units (local or external)
- Configuration of arithmetic expressions for calculating setpoints for transitions and recipe parameters from recipe variables and constants
- Documentation of master recipes and library operations
- Validation under inclusion of user-specific plausibility checks
- Selection of unit candidates via a class-based view or limitation of the equipment properties
- Releasing master recipes and library operations for test or production

8

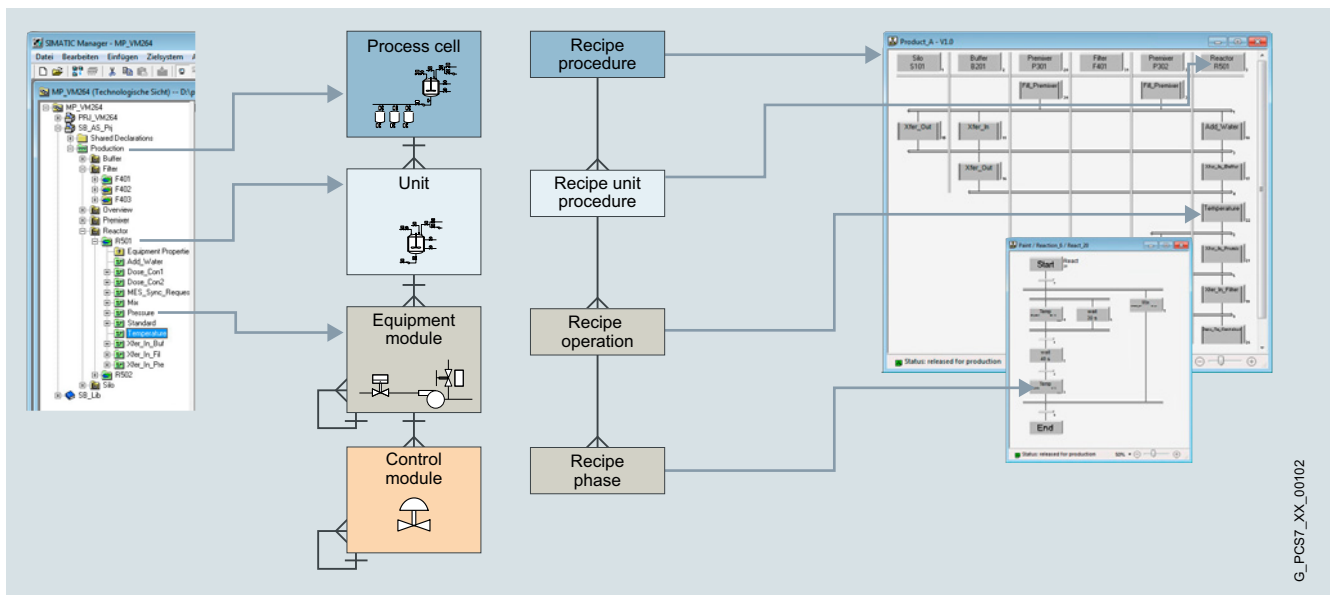
Hierarchical recipes according to ISA-88.01

Hierarchical recipes according to ISA-88.01

G_PCS7_XX_00102

SIMATIC PCS 7 system software

Batch automation
SIMATIC BATCH

SIMATIC BATCH software

Function (continued)

SIMATIC BATCH supports hierarchical recipes in accordance with the ISA-88.01 standard. SIMATIC BATCH and SIMATIC PCS 7 form a functional unit that fully covers the models described in the standard.

The hierarchical recipe structure is mapped on the plant module as follows:

- Recipe procedure for controlling the process or the production in a plant
- Recipe unit procedure for controlling a process step in a plant unit
- Recipe operation/function for the process engineering task/function in an equipment module

Recipe elements for handling of exceptions

Monitoring of process states is possible during runtime by marking freely selectable recipe sections. It is then possible to automatically react to evaluated events or faults using a command block or jump function in a special container.

ROP Library

Recipe operations managed in a user library (ROP library) can be installed in the recipe procedures of hierarchical recipes as a reference and thus modified centrally.

This reduces the effort for engineering and validation.

If the reference link is broken, the recipe operation becomes a fixed component of the recipe procedure, and is thus independent of further central modifications.

Separation Procedures/Formulas

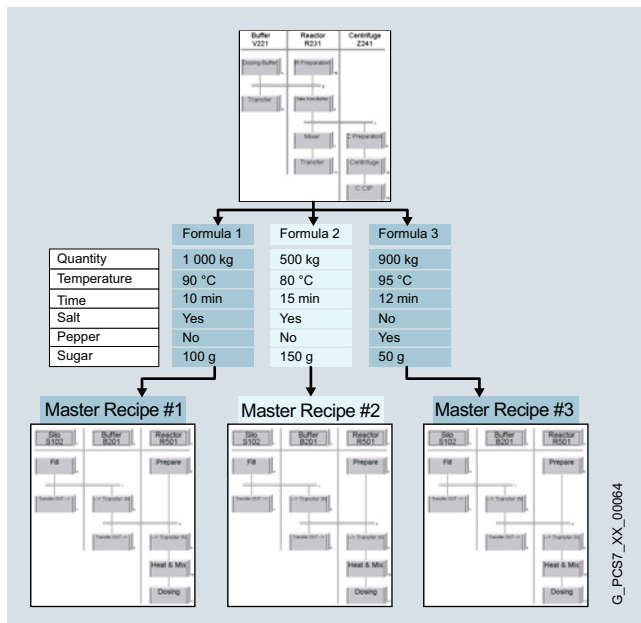

The flexibility achieved by recipes which are independent of specific units can be increased even further if the procedure and parameter sets (formulas) are separated from one another. Various master recipes can be created by linking several formulas using 1 recipe procedure. This enables central modification of procedures. The formula structure is determined by the formula defined by the user.

Batch Control Center (BatchCC)

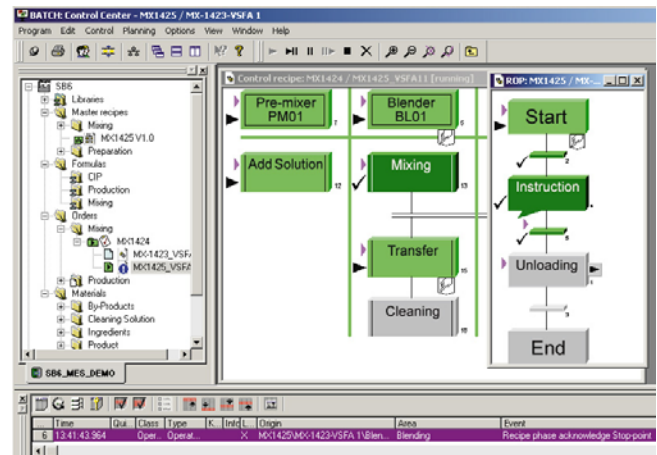

The SIMATIC BATCH Batch Control Center (BatchCC) is the "command center" for monitoring and controlling batch processes with SIMATIC BATCH. Using BatchCC you can manage all data relevant to SIMATIC BATCH through a graphical user interface.

BatchCC offers powerful functions for the following tasks:

- Import and update of basic automation plant data
- Definition of user privileges for all functions, for clients, or for plant units of SIMATIC BATCH
- Definition of material names and codes
- Management of master recipes
- Management of libraries with recipe elements (library operations)
- Editing of formula categories and management of associated formulas
- Creation of master recipes from control recipe
- Exporting and importing of master recipes, formulas and library objects
- Creation of batches with master recipes
- Starting of batch processing and controlling of batches
- Monitoring and diagnostics of batch processing
- Allocation strategy for recipe creation and unit allocation at batch runtime
- Online modification, deletion or insertion of objects (RPH, ROP, RUP) and structure elements (loops, transitions, etc.) of the recipe (special privileges and explicit authorization required)
- Recording and archiving of recipes and batch data
- Opening SFC visualization directly from the control recipe

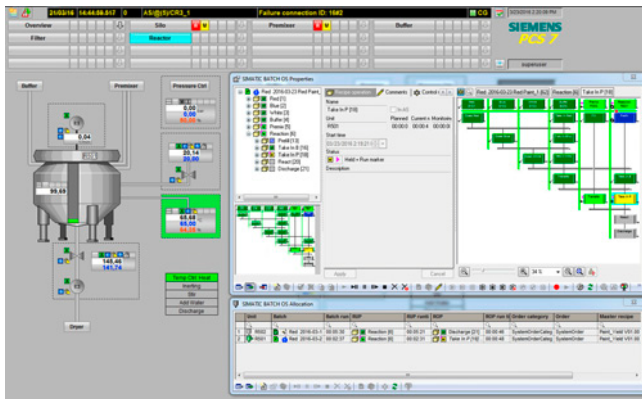
Function (continued)
Batch OS Control

Batch OS Control

OS Controls which can be directly superimposed on the process display provide you with a practical alternative to BatchCC for the operation and monitoring of batch processes.

The following OS controls are available:

- Unit overview
- ROP overview
- Batch creation
- Job and batch overview
- Batch operation and monitoring

The BATCH OS controls are also web-supported, i.e. operator control and monitoring is possible on a PCS 7 Web Client.

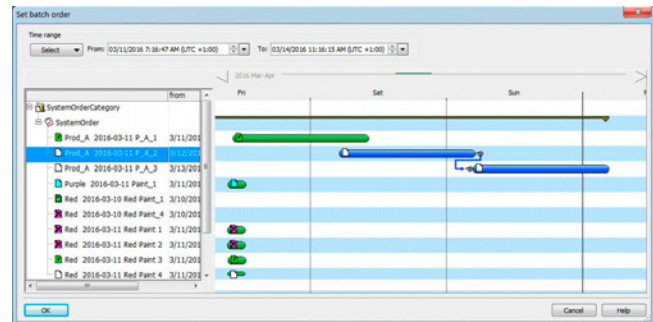
Batch planning

Batch Control Center enables the creation of individual production orders and batches. However, Batch Planning offers significantly more planning functions. The batches for a large number of production orders can then be planned in advance.

The functional scope not only includes planning, but also modification, cancellation, deletion and release of batches. Creation and distribution of the batches for a production order are possible manually, but can also be carried out automatically depending on the definition of the batch number or production quantity.

The following batch properties can be set and changed:

- Quantity
- Start mode (immediately, following operator input, or time-driven)
- Unit allocation
- Formula
- Run sequence (chaining to previous or subsequent batch)
- Displaying the runtime of a batch
- Definition of minimum time interval for batch chaining

Batch planning and control are supported in a user-friendly manner and simplified, thanks to special displays such as the order category list, production order list, batch planning list, batch status list, or batch results list.

All batches including their unit allocation can be clearly presented in a combination of Gantt diagram and table. Time conflicts or those resulting from multiple allocation of units are identified by symbols. Time conflicts can be eliminated simply by shifting the associated batches in the Gantt diagram.

SIMATIC Batch API

The SIMATIC BATCH API Application Programming Interface, which is offered as an expansion component, is an open interface for customer-specific extensions. It provides users with access to data and functions of SIMATIC BATCH and enables programming of special applications for specific sectors or projects.

SIMATIC PCS 7 system softwareBatch automation
SIMATIC BATCH**SIMATIC BATCH software****Ordering data****Article No.****Article No.****Basic software for Batch Single Station, Batch Server and Batch Client**

Runs with the following operating systems (see SIMATIC PCS 7 V9.1 Readme for the latest information¹⁾):

- Windows 10 2019 LTSC
- Windows Server 2019

SIMATIC BATCH**Single Station Package V9.1**

6 languages (English, German, French, Italian, Spanish, Chinese), software class A, single license for 1 installation

Without SIMATIC PCS 7 Software Media Package

- Goods delivery
License key on USB flash drive, Certificate of License
- Online delivery
License key download, online Certificate of License
Note: Email address required!

6ES7657-0UX68-0YB0**6ES7657-0UX68-0YH0****SIMATIC BATCH Basic V9.1**

Batch server software with reduced functionality

6 languages (English, German, French, Italian, Spanish, Chinese), software class A, single license for 1 installation

Without SIMATIC PCS 7 Software Media Package

- Goods delivery
License key on USB flash drive, Certificate of License
- Online delivery
License key download, online Certificate of License
Note: Email address required!

6ES7657-0YX68-0YB0**6ES7657-0YX68-0YH0****SIMATIC BATCH Server V9.1**

6 languages (English, German, French, Italian, Spanish, Chinese), software class A, single license for 1 installation

Without SIMATIC PCS 7 Software Media Package

- Goods delivery
License key on USB flash drive, Certificate of License
- Online delivery
License key download, online Certificate of License
Note: Email address required!

6ES7657-0TX68-0YB0**6ES7657-0TX68-0YH0****SIMATIC BATCH Client V9.1**

6 languages (English, German, French, Italian, Spanish, Chinese), software class A, floating license for 1 user

Without SIMATIC PCS 7 Software Media Package

- Goods delivery
License key on USB flash drive, Certificate of License
- Online delivery
License key download, online Certificate of License
Note: Email address required!

6ES7657-0VX68-0YB5**6ES7657-0VX68-0YH5****Functional add-on components**

Runs with the following operating systems (see SIMATIC PCS 7 V9.1 Readme for the latest information):

- Windows 10 2019 LTSC
- Windows Server 2019

SIMATIC BATCH**Recipe System V9.1**

For recipe creation; installation on at least one client of a client/server system (alone or in combination with the SIMATIC BATCH client software)

6 languages (English, German, French, Italian, Spanish, Chinese), software class A, floating license for 1 user

Without SIMATIC PCS 7 Software Media Package

- Goods delivery
License key on USB flash drive, Certificate of License
- Online delivery
License key download, online Certificate of License
Note: Email address required!

6ES7657-0AX68-0YB5**6ES7657-0AX68-0YH5****SIMATIC BATCH API V9.1**

1 language (English), software class A, single license for 1 installation

Without SIMATIC PCS 7 Software Media Package

- Goods delivery
License key on USB flash drive, Certificate of License
- Online delivery
License key download, online Certificate of License
Note: Email address required!

6ES7657-0MX68-2YB0**6ES7657-0MX68-2YH0**

Ordering data	Article No.	Article No.
<p>Quantity options for Batch Single Station and Batch Server (cumulative)</p> <p>SIMATIC BATCH UNITS²⁾ For SIMATIC BATCH Single Station Package/SIMATIC BATCH Server software</p> <p>Language-neutral, software class A, single license for 1 installation</p> <p>Without SIMATIC PCS 7 Software Media Package</p> <ul style="list-style-type: none"> • Goods delivery License key on USB flash drive, Certificate of License <ul style="list-style-type: none"> - 1 UNIT - 10 UNITS - 50 UNITS • Online delivery License key download, online Certificate of License <u>Note:</u> Email address required! <ul style="list-style-type: none"> - 1 UNIT - 10 UNITS - 50 UNITS 	<p>6ES7657-0XA00-0YB0 6ES7657-0XB00-0YB0 6ES7657-0XC00-0YB0</p> <p>6ES7657-0XA00-0YH0 6ES7657-0XB00-0YH0 6ES7657-0XC00-0YH0</p>	<p>SIMATIC BATCH Server Expansion Pack (500 MB) V9.1 6 languages (English, German, French, Italian, Spanish, Chinese), software class A, single license for 1 installation</p> <p>Without SIMATIC PCS 7 Software Media Package</p> <ul style="list-style-type: none"> • Goods delivery License key on USB flash drive, Certificate of License • Online delivery License key download, online Certificate of License <u>Note:</u> Email address required! <p>6ES7657-0QX58-2YB0</p> <p>6ES7657-0QX58-2YH0</p>
<p>SIMATIC BATCH OS Control Web Client For SIMATIC BATCH Single Station Package/SIMATIC BATCH Server software</p> <p>Language-neutral, software class A, single license for 1 installation</p> <p>Without SIMATIC PCS 7 Software Media Package</p> <ul style="list-style-type: none"> • Goods delivery License key on USB flash drive, Certificate of License <ul style="list-style-type: none"> - 1 Web Client - 5 Web Clients • Online delivery License key download, online Certificate of License <u>Note:</u> Email address required! <ul style="list-style-type: none"> - 1 Web Client - 5 Web Clients 	<p>6ES7657-0XF00-0YB0 6ES7657-0XG00-0YB0</p> <p>6ES7657-0XF00-0YH0 6ES7657-0XG00-0YH0</p>	<p>¹⁾ See "Software Media and Logistics" section, under "System documentation", see page 1/7</p> <p>²⁾ Instances of plant units</p>

SIMATIC PCS 7 system software

Notes

Route Control



9/2

9/5

9/7

SIMATIC Route Control

SIMATIC Route Control runtime software

Route Control engineering software

SIMATIC PCS 7 system software

Route Control

SIMATIC Route Control

Overview

Flexible route management with SIMATIC Route Control

P&ID (Example)

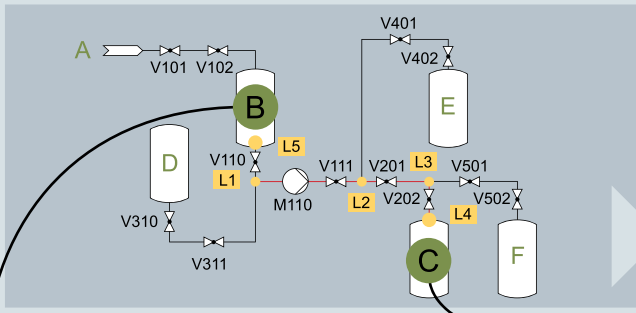

Route example with partial route functions

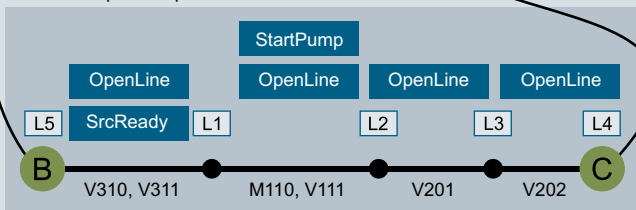

Multiplexing with Route Control

Route	ID	Mode	Func	Mode Info	Material	Tag	Batch Name	Source
R1	001	AS28	DI					
R2	002	AS28	DI					
R3	003	AS28	DI					
R4	004	AS28	DI					

G_PCS7_XX_00880

Management of route processes

With SIMATIC Route Control, the SIMATIC PCS 7 process control system offers an innovative and proven route management system at the same time. Due to its flexibility and scalability, SIMATIC Route Control can be used beneficially for almost any plant scale in a wide range of industries.

Using SIMATIC Route Control, engineering and planning offices as well as plant operators can significantly reduce project configuration and commissioning costs and at the same time increase configuration quality. Thanks to the flexible "multiplexing" capability of SIMATIC Route Control, plant expansions often no longer require new configuration. They can instead be configured during operation. Actuator control can be rescheduled and adapted during runtime. SIMATIC Route Control thus offers the highest degree of flexibility with unconditional assurance of plant safety.

SIMATIC Route Control can be profitably used for a wide range of applications. It significantly increases safe plant operation through automated, controlled actuator activation with simultaneous monitoring of interlocks, limits and material compatibility. The very easy-to-use operator interface of SIMATIC Route Control significantly reduces plant complexity for the plant operator and avoids operator errors. The optional redundancy of the Route Control Servers and the automation system-based control of routes ensure the high system availability required in many industries. The detailed documentation of operator interventions and the system activities enable full tracking of routing processes, which is especially required in validated environments.

Application

SIMATIC Route Control can be profitably used for almost any plant size in a wide range of applications in the process industries.

SIMATIC Route Control shows its strengths in the following situations, among others:

- High plant safety combined with maximum flexibility for route control required.
- Operator errors should be specifically avoided by employing automatism

- Frequent changes to the route network are necessary due to modifications or expansion, including the involved actuators and sensors
- Materials used are incompatible or change frequently
- Source and destination (including reversal of direction for bidirectional routes) should be able to be specified dynamically
- Routes are often controlled in parallel
- Plant projects are executed with SIMATIC BATCH

Design

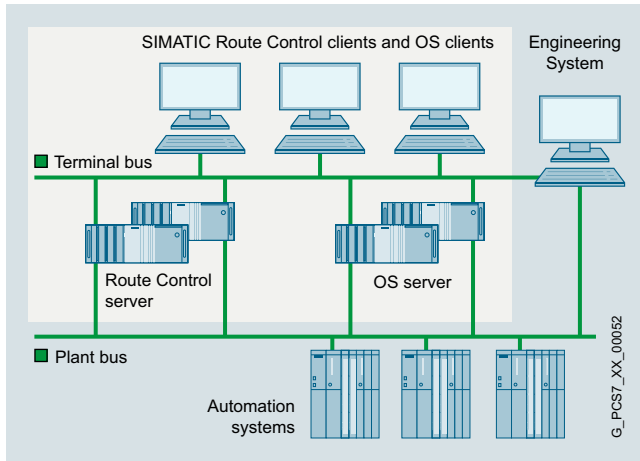

The modularity and flexibility of SIMATIC Route Control are optimally supported by the hardware available. The SIMATIC PCS 7 Industrial Workstations from the "Industrial Workstation/IPC" section can be used for SIMATIC Route Control.

Hardware for small plants

With small plants, SIMATIC Route Control Client and Server can be installed together with the OS software on a single-station system to save costs. You can select the hardware for this OS/RC single station from the section "Industrial Workstation/IPC", under "SIMATIC Rack PC".

Client/server configuration

In medium and large plants, the SIMATIC Route Control route management system is typically used as a distributed multi-station system with client-server architecture. Depending on the application, it is generally possible to operate SIMATIC Route Control Server, SIMATIC Batch Server and SIMATIC OS Server on common basic hardware. Taking into account the availability and performance requirements of the respective application, it must be decided whether separate server hardware must be provided for each component.

The availability of the RC Server can be increased further by a redundant design of the SIMATIC Route Control Server hardware. SIMATIC PCS 7 supports a SIMATIC Route Control Server or pair of SIMATIC Route Control Servers for each multi-user system.

The SIMATIC Route Control Client (RC Client) is represented by the SIMATIC Route Control Center (RCC). The RCC can be installed on a SIMATIC OS Client, a SIMATIC Batch Client or separate client hardware.

Increasing plant availability due to the use of redundant SIMATIC Route Control Servers

The SIMATIC Route Control Server software supports SIMATIC Route Control Server redundancy. Additional software components or separate connection between the two servers are not required.

With the assistance of the SIMATIC Route Control Server software, the two redundant SIMATIC Route Control Servers monitor each other during operation. If the active SIMATIC Route Control Server fails, the redundant partner takes over operation. In this case, the SIMATIC Route Control Clients are automatically switched to the new active SIMATIC Route Control Server. Once the failed SIMATIC Route Control Server has resumed operation, data is synchronized with the active SIMATIC Route Control Server.

Supported automation systems

SIMATIC Route Control supports standard automation systems, fault-tolerant and safety-related automation systems of the S7-400 range based on the following CPU types:

- CPU 416 3 (parallel control of up to 30 routes)
- CPU 417-4 and CPU 417-4H (parallel control of up to 300 routes)
- CPU 410 5H (parallel control of up to 300 routes)
- PCS 7 BOX

SIMATIC PCS 7 system software

Route Control

SIMATIC Route Control

Configuration

The SIMATIC PCS 7 Route Control system has a modular design and can be flexibly adapted to the respective application. In accordance with the growing demand of a plant, the required number of routes can be flexibly adapted using additional SIMATIC Route Control Routes software packages (10 and 50 route packages) up to the project upper limit of 300 routes.

The data managed by SIMATIC Route Control is protected against unauthorized access by a role/rights system. SIMATIC Logon as the central SIMATIC PCS 7 component for user management ensures optimum user administration.

SIMATIC Route Control Engineering – Individual interconnection of blocks no longer necessary

The central SIMATIC PCS 7 engineering system also provides SIMATIC Route Control Engineering in addition to other things. This includes the SIMATIC Route Control Library (for controlling route elements, etc.) and the SIMATIC Route Control Wizard for automated support of project configuration.

To control and monitor elements of a plant, blocks from a SIMATIC PCS 7 library are conventionally installed in CFCs in SIMATIC PCS 7 and interconnected with plant control blocks according to the technological requirements. Individual connection of the blocks is no longer necessary with SIMATIC Route Control (RC)! The standard blocks of the technological elements relevant for SIMATIC Route Control (RC elements) are adapted via uniform, reduced interface blocks of the SIMATIC Route Control Library. SIMATIC Route Control then takes of the control and monitoring of the elements.

The advantages of controlling and monitoring technological elements with SIMATIC Route Control are also possible in existing plants without increased work. Changes in the SIMATIC Route Control engineering project can be recorded and documented with a change log.

SIMATIC Route Control Runtime - Route management based on multiplexers

To control a route, the operator requests a route via SIMATIC Route Control Center, specifying source, destination and optional waypoints. Alternatively, the control of a route can also be automated (e.g. via SIMATIC Batch).

After successfully searching for a requested route, SIMATIC Route Control Server is ready to control the route. The control of a route takes place according to a defined function catalog, which contains the sequence and configuration of the control functions (control strategies). The SIMATIC Route Control Server (RC Server) supplies the SIMATIC Route Control Clients (Route Control Center) with the necessary data and transfers their operating information to the automation systems.

The detailed operating messages generated by SIMATIC Route Control allow all operating actions to be traced at any time (audit trail). SIMATIC Route Control can be used to request and safely perform maintenance work on automation systems. The automation systems involved can be specifically placed "in maintenance" (out of service). SIMATIC Route Control waits for the termination of active route controls for this.

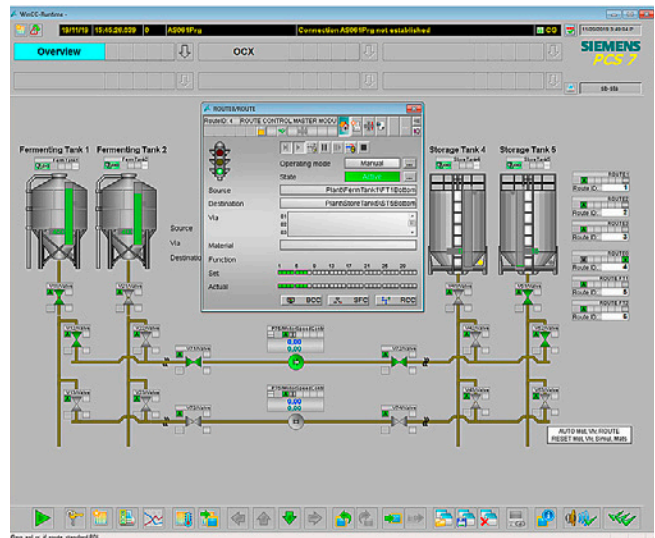

Route Control master module

SIMATIC Route Control block icons representing a specific route can be added to process pictures of SIMATIC PCS 7 operator stations. A SIMATIC Route Control block icon references a corresponding SIMATIC Route Control faceplate that displays detailed information about the route and allows the route to be operated.

Overview

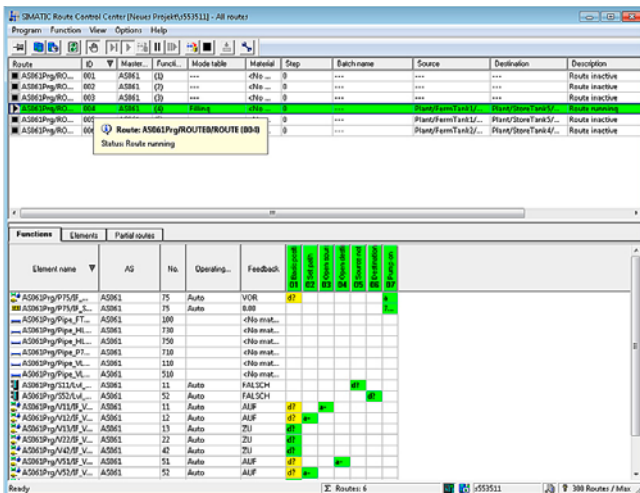

SIMATIC Route Control Center

Software components (runtime)	RC Single Station	RC Server single	RC Server redundant		RC Client
			Server A	Server B	
SIMATIC Route Control Server	●	●	●	●	—
SIMATIC Route Control Center	●	—	—	—	●

Quantity options: cumulative SIMATIC Route Control Routes¹⁾

• 10 routes ¹⁾	○	○	○	○	—
• 50 routes ¹⁾	○	○	○	○	—

SIMATIC Route Control software for RC Single Station, RC Server, and RC Client

¹⁾ Number of simultaneous material transports; at least one "SIMATIC Route Control Routes" license (for sets of 10/50) is required per project, total project limit: 300 routes

- Software product/license required
- Software product/license optional
- Software product/license not required or not available

Due to its software structure, SIMATIC Route Control can be flexibly adapted to different plant sizes and architectures (single-user/multi-user systems):

- SIMATIC Route Control Engineering (components of the SIMATIC PCS 7 Engineering System)
- SIMATIC Route Control Server
- SIMATIC Route Control Center (RCC)

SIMATIC Route Control and SIMATIC Operator System work together harmoniously and efficiently. For small plants, this makes it possible to install Route Control Center and Route Control Server together with SIMATIC Operator System software on a Single Station. The ordering data for the OS software can be found in the section "Operator System".

In the case of multiple station systems with low configuration limits, it is also possible to operate the SIMATIC Route Control Server, SIMATIC Batch Server and SIMATIC OS Server on shared basic hardware. However, to further increase both the availability and the performance of the SIMATIC PCS 7 system, it is recommended to install the respective server software on separate server hardware.

The SIMATIC Route Control Center (RCC) can be installed on a SIMATIC OS Client, a SIMATIC Batch Client or on separate SIMATIC Route Control Client hardware.

In addition to the SIMATIC Route Control Server and SIMATIC Route Control Center runtime software, SIMATIC Route Control software packages that can be ordered separately are also required for a SIMATIC Route Control project, depending on the size of the plant. This software licenses the use of a certain number of routes (cumulative 10 and 50 quantity options for the number of simultaneously controlled routes). Several sets of 10 and 50 SIMATIC Route Control Routes licenses can be combined up to a total project limit of 300 routes.

Function

SIMATIC Route Control Server

The SIMATIC Route Control Server supplies the Route Control Clients (faceplate or SIMATIC Route Control Center) with data and forwards operating information to the automation systems. When there is a requested route search, the SIMATIC Route Control Server has the task of finding an optimum route based on specified parameters (source, destination, waypoints) and taking into account other parameters (e.g. mode tables, function or material identifiers). Changes in the project configuration are made available to the SIMATIC Route Control Server by a simple loading and activation process and are then taken into account for new route searches.

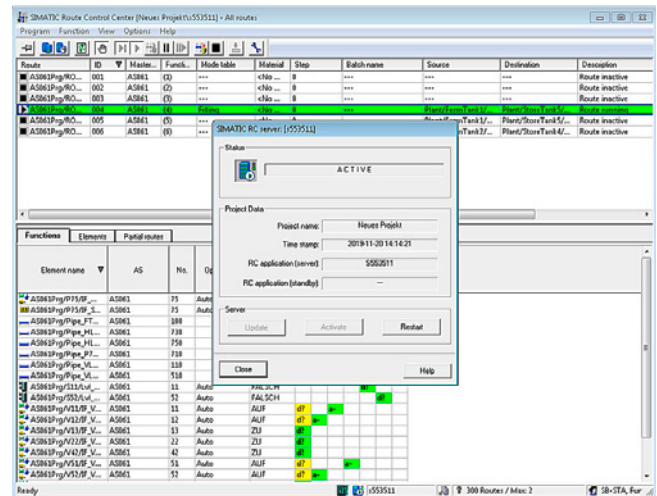

SIMATIC Route Control Server

SIMATIC PCS 7 system software

Route Control

SIMATIC Route Control

Route Control runtime software**Function** (continued)**SIMATIC Route Control Center (RCC)**

The SIMATIC Route Control Center displays an overview of all routes known to the SIMATIC Route Control Server including all detailed information.

Key functional features are:

- Overview of all SIMATIC Route Control elements, partial routes and request details
- Configuration and operation of the routes:
 - Selection of operating mode: Manual/automatic
 - Request, start, stop, continue and terminate route in manual mode
 - Set/modify request parameters (origin, destination, intermediate points) as well as general properties (mode table, function ID, material ID and "ignore error") in manual mode
 - Enable/disable sequence functions in manual mode
- Extensive diagnostic options for route requests (e.g. detection of request errors due to blocked elements or blocked partial routes, detection of inconsistent actuations or prohibited follow-up materials)
- Extensive diagnostics of ongoing material transports (e.g. color and textual status display of routes; detailed analyses by evaluating feedback from SIMATIC Route Control elements)
- Operation of server functions (e.g. selecting SIMATIC Route Control Server, displaying its status and re-reading data)
- Display of operator who has logged on
- Definition of route parameters (source, destination, material, function ID etc.), and saving and loading these settings
- Management of the maintenance function for automation systems

Ordering data**Article No.****SIMATIC Route Control Server V9.1 for single station or client/server configuration**

6 languages (English, German, French, Italian, Spanish, Chinese), software class A

Runs with Windows 10 Enterprise 2019 LTSC or Windows Server 2019 Standard Edition 64-bit (see SIMATIC PCS 7 V9.1 Readme for the latest information¹⁾)

Single license for 1 installation, without SIMATIC PCS 7 Software Media Package

- Goods delivery
License key on USB flash drive, Certificate of License
- Online delivery
License key download, online Certificate of License
Note: Email address required!

6ES7658-7FX68-0YB0**6ES7658-7FX68-0YH0****Quantity options for single station/server (cumulative)****SIMATIC Route Control Routes²⁾**

For expansion of the SIMATIC Route Control Server software for single station or client/server configuration, cumulative

Language-neutral, software class A, single license for 1 installation

Without SIMATIC PCS 7 Software Media Package

- Goods delivery
License key on USB flash drive, Certificate of License
 - 10 routes²⁾
 - 50 routes²⁾
- Online delivery
License key download, online Certificate of License
Note: Email address required!
 - 10 routes²⁾
 - 50 routes²⁾

6ES7658-7FF00-0XB0**6ES7658-7FG00-0XB0****6ES7658-7FF00-0XH0****6ES7658-7FG00-0XH0****SIMATIC Route Control Center V9.1**

6 languages (English, German, French, Italian, Spanish, Chinese), software class A

Runs with Windows 10 Enterprise 2019 LTSC or Windows Server 2019 Standard Edition 64-bit (see SIMATIC PCS 7 V9.1 Readme for the latest information¹⁾)

Floating license for 1 user, without SIMATIC PCS 7 Software Media Package

- Goods delivery
License key on USB flash drive, Certificate of License
- Online delivery
License key download, online Certificate of License
Note: Email address required!

6ES7658-7EX68-0YB5**6ES7658-7EX68-0YH5**

¹⁾ See "Software Media and Logistics" section, under "System documentation", see page 1/7

²⁾ Number of simultaneous material transports; total project limit: 300 routes

Overview

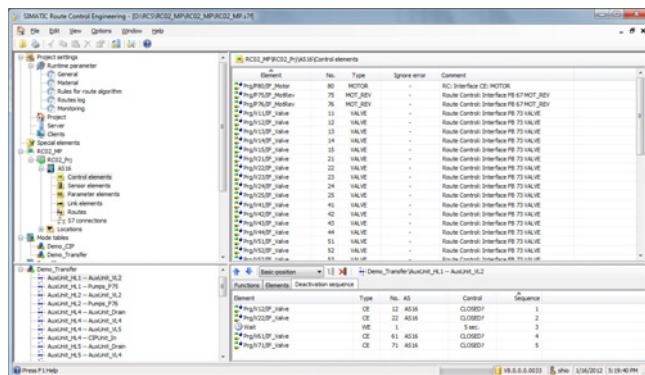

SIMATIC Route Control Engineering

With SIMATIC Route Control Engineering, SIMATIC PCS 7 plant engineering is extended by adapting technological elements relevant for SIMATIC Route Control. This adaptation is a standardized process requiring little effort. This procedure also enables the uncomplicated extension of existing plants.

The adaptation is performed using the CFC Editor using standardized interface blocks from the SIMATIC Route Control Library.

Function

In addition to the basic tools of the SIMATIC PCS 7 Engineering System (SIMATIC Manager, CFC, etc.), the following components from the SIMATIC Route Control Engineering program package are available for configuring SIMATIC Route Control applications:

SIMATIC Route Control Library

The SIMATIC Route Control Library contains blocks for configuring the SIMATIC Route Control system and for route representation and adaptation of the route elements. It is provided in the catalog of the CFC editor.

SIMATIC Route Control Wizard

The SIMATIC Route Control Wizard supports and simplifies the SIMATIC Route Control engineering process. It automatically recognizes the configuration data of the SIMATIC PCS 7 project specific to SIMATIC Route Control and prepares it for SIMATIC Route Control engineering. In addition to incoming plausibility checks, it defines the communication links between AS-OS and AS-AS (NetPro and CFC) and configures the SIMATIC Route Control Server messages, for example.

SIMATIC Route Control Engineering – Configuration of the route management

SIMATIC Route Control Engineering is used to configure the objects relevant for the route management system. This process takes place after data preparation by the SIMATIC Route Control Wizard.

The following objects are relevant here:

- **Partial routes:**
Routes are made up of partial routes. Partial routes provide specific information for the route search (e.g. flow direction, priority) and at the same time increase the flexibility of the route search.
- **Interconnections:**
The term "interconnection" refers to the installation of a SIMATIC Route Control element in a partial route. Through this process, SIMATIC Route Control elements receive functions or properties of the partial route (e.g. in the initial state: "close valve").
- **Function catalogs:**
A function catalog is a grouping of several related control strategies (also referred to as function levels) - e.g. "Cleaning", "Sterilization" or "Material transfer". The partial routes can be assigned to function catalogs according to technological and product-specific aspects. Function catalogs serve as search criteria for route searches, for example.
- **Function stages:**
Function catalogs can contain up to 32 function levels (control strategies). The function levels are used to determine the control of the SIMATIC Route Control connected in partial routes (e.g. basic position of the control elements, open source valve, switch on pump).

The configuration of partial routes, function catalogs and function levels is performed using a user-friendly matrix.

SIMATIC PCS 7 system software

Route Control SIMATIC Route Control

Route Control engineering software

Function (continued)

Graphical offline route search

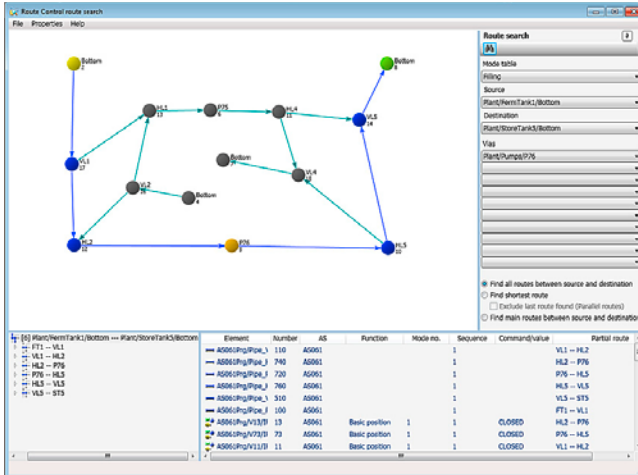

Graphical offline route search for checking the route network

A route search independent of the runtime system is possible with SIMATIC Route Control Engineering. Comparable to a navigation system, the graphically visualized offline route search determines possible route options.

Errors in the route network can be detected already during the engineering phase. According to the preferences, a preferred route can be selected from the offline route search results and saved as a static route.

Ordering data

Article No.

SIMATIC Route Control Engineering V9.1

6 languages (English, German, French, Italian, Spanish, Chinese), software class A

Runs with Windows 10 Enterprise 2019 LTSC or Windows Server 2019 Standard Edition 64-bit (see SIMATIC PCS 7 V9.1 Readme for the latest information¹⁾)

Floating license for 1 user, without SIMATIC PCS 7 Software Media Package

- Goods delivery
License key on USB flash drive, Certificate of License
- Online delivery
License key download, online Certificate of License
Note: Email address required!

6ES7658-7DX68-0YB5

6ES7658-7DX68-0YH5

¹⁾ See "Software Media and Logistics" section, under "System documentation", see page 1/7

Safety Integrated for Process Automation



10/2	Introduction
-------------	---------------------

- | | |
|-------------|----------------------------------|
| 10/6 | SIMATIC Safety Integrated |
| 10/6 | SIMATIC S7 fail-safe systems |
| 10/8 | SIMATIC S7 Safety Matrix |

10/12	Functional Safety Services
--------------	-----------------------------------

SIMATIC PCS 7 system software

Safety Integrated for Process Automation

Introduction

Overview

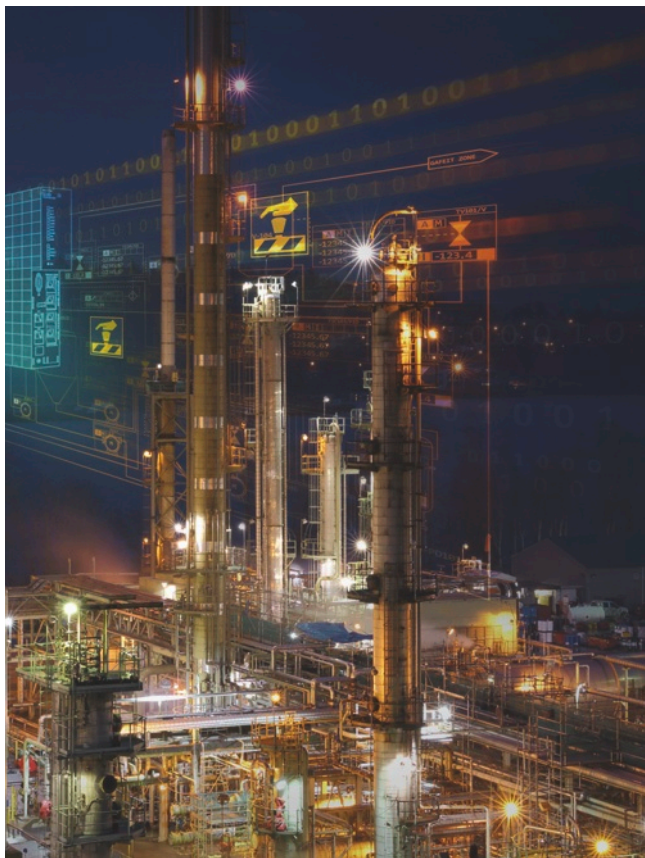

The process industry frequently features complex technological sequences with high safety demands, and faults and failures in the process automation could have fatal consequences for personnel, machines, plants and the environment. The safety technology used must reliably detect dangerous states in the process and also its own internal errors, and automatically set the plant/application to a safe state.

Safety Integrated for Process Automation is the comprehensive range of products and services from Siemens for safe, fault-tolerant applications in the process industry. This is characterized by:

- Safety-oriented F/FH automation systems of the S7-400 series (see "Automation Systems" section)
- Safe communication with the PROFIsafe profile via PROFIBUS (see section "Industrial Communication, PROFIBUS") or PROFINET (see section "Industrial Communication, PROFINET")
- Fail-safe transmitters (SITRANS P DS III) on the PROFIBUS PA with PROFIsafe (see Catalog FI 01, Field devices for process automation)
- ET 200SP HA, ET 200iSP, ET 200M, ET 200S and ET 200pro distributed I/O systems with safety-oriented F-I/O modules/submodules (see "Process I/O" section)
- Fail-safe process instruments/devices for connection to ET 200 distributed I/O systems (see Catalog FI 01, Field Instruments for Process Automation)
- SIMATIC Safety Integrated software for implementation and operation of safety applications, with additional components for the Engineering System and the operator stations: SIMATIC S7 F-systems, SIMATIC S7 Safety Matrix
- Special applications, for example, Partial Stroke Test
- Safety lifecycle management with support by highly qualified solution partners: services for all phases in the lifecycle of a safety instrumented system (analysis, implementation, and operation)

Benefits

Safety Integrated for Process Automation enables full integration of safety technology in the SIMATIC PCS 7 process control system. The Basic Process Control System (BPCS) and Safety Instrumented System (SIS) combine seamlessly to form a uniform and innovative complete system. The advantages of this fusion are quite clear:

- One common controller platform
- One common engineering system
- No separate safety bus – standard and safety-related communication take place on the same fieldbus (PROFIBUS/PROFINET with PROFIsafe)
- Mixed operation of standard and safety-related I/O modules in SIMATIC ET 200SP HA, SIMATIC ET 200iSP, SIMATIC ET 200M and SIMATIC ET 200pro remote I/O stations

- Integrated data management – no complex data exchange between BPCS and SIS
- Integration of safety-related applications into process visualization on the operator station
- Automatic integration of safety-related fault messages with time tagging into the process control system
- Integration of safety-related hardware into the asset management with the SIMATIC PCS 7 Maintenance Station for diagnostics and preventive maintenance

Design

The PROFIsafe profile allows safety-related communication between the automation system (controller) and the process I/O via either PROFIBUS or PROFINET. The decision for choosing either PROFINET IO or the PROFIBUS DP/PA fieldbuses has a significant influence on the architecture of the safety-related system.

Safety-related design versions with PROFIBUS

In the case of a safety-related system with PROFIBUS communication integrated into SIMATIC PCS 7, a distinction is made across all architecture levels between two design versions:

- Single-channel, non-redundant design
- Redundant, fault-tolerant design

Both design versions are extremely variable, and offer a large scope for different customer requirements. Standard automation (basic process control) and safety-related functions can be combined flexibly, not only in the area of distributed I/O. Even at the controller level, they can be combined in one system or separated. In addition, there are numerous possibilities arising from the use of flexible modular redundancy.

10

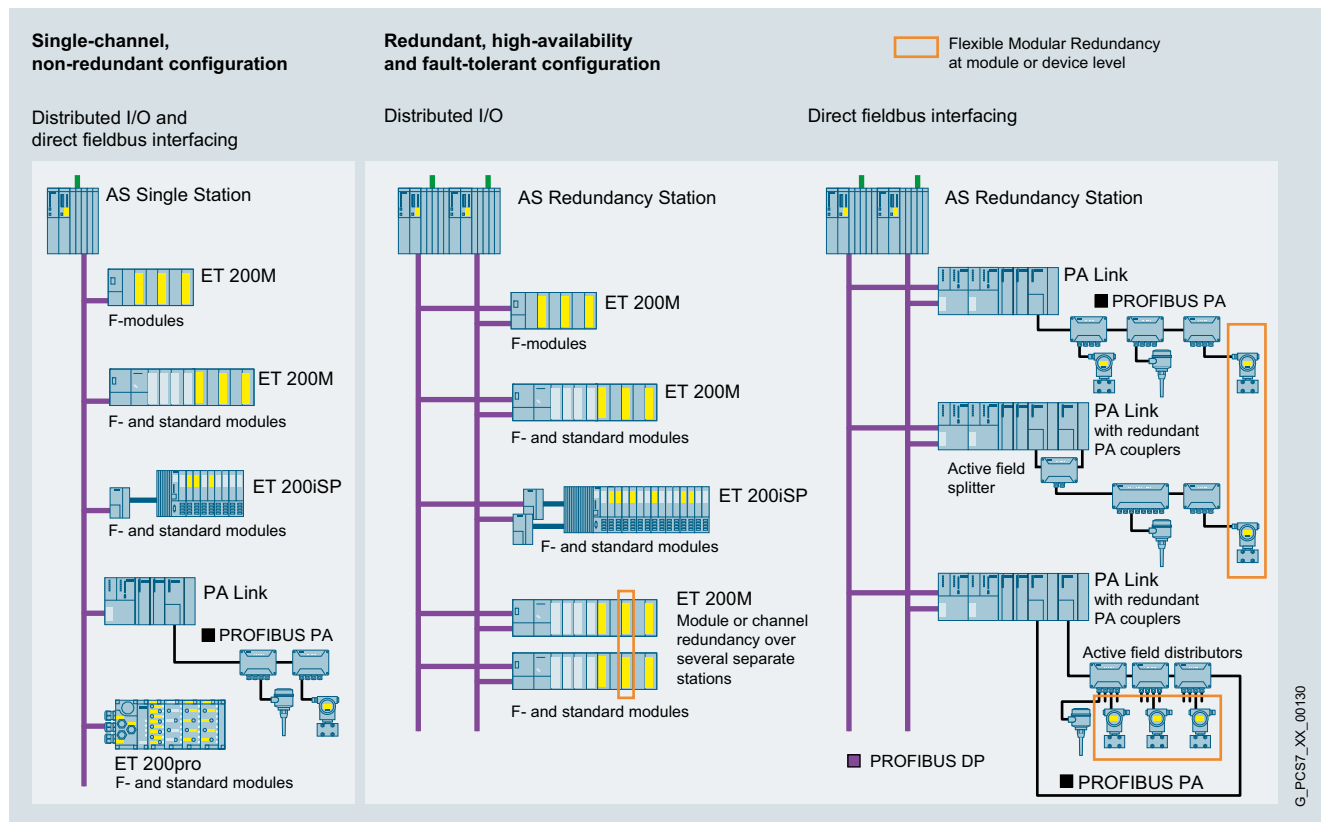

Safety-related design versions with PROFIBUS

SIMATIC PCS 7 system software

Safety Integrated for Process Automation

Introduction

Design

At the individual architectural levels (controller, fieldbus, I/O), you have the configuration alternatives shown in the figure in line with the I/O used (ET 200SP HA, ET 200iSP, ET 200M and ET 200pro remote I/O stations or PROFIBUS PA devices with PA profile 3.0 or higher).

Safety-related design versions with PROFINET

Safety-related AS single stations (F systems) and AS redundancy stations (FH systems) from the S7-400 range can be networked simply and effectively with ET 200M remote I/O stations via PROFINET IO. For this purpose, the PN/IE interface integrated in the CPU and the corresponding PROFINET interface module in the remote I/O stations (e.g. IM 155-6 PN HA for ET 200SP HA) are available on the automation system side.

The availability of the I/O devices on an AS Single Station (F-system) can be increased by a ring topology with media redundancy. If the transmission link in the ring is interrupted at one point, for example, due to a break in the ring cable or the failure of a station, the redundancy manager then immediately activates the alternative communication path.

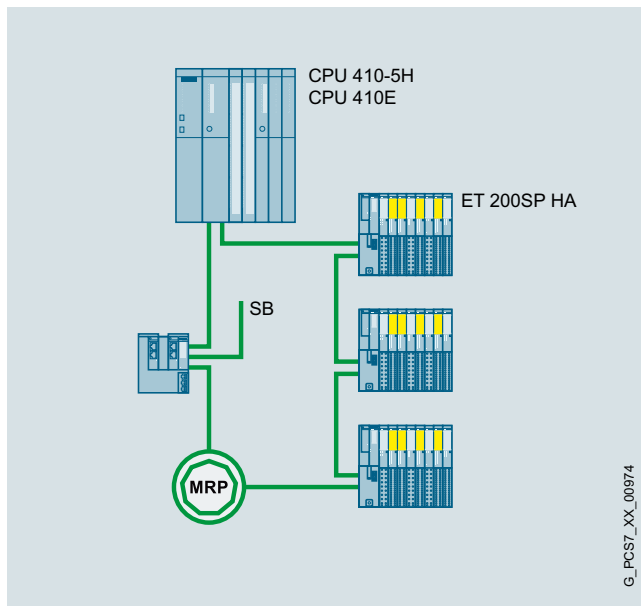

Safety-related PROFINET IO communication with media redundancy

The maximum availability with minimum error handling times is achieved by the AS Redundancy Station (FH system) in conjunction with the redundant PROFINET configuration R1. From the CPUs of the H system onwards, the R1 devices are connected via two separate line structures. In order to increase availability, we recommend reverse cabling (as shown in the blueprint). In contrast to the single-sided I/O device connection to only one CPU, failure of a CPU in this case does not automatically lead to failure of the connected I/O devices.

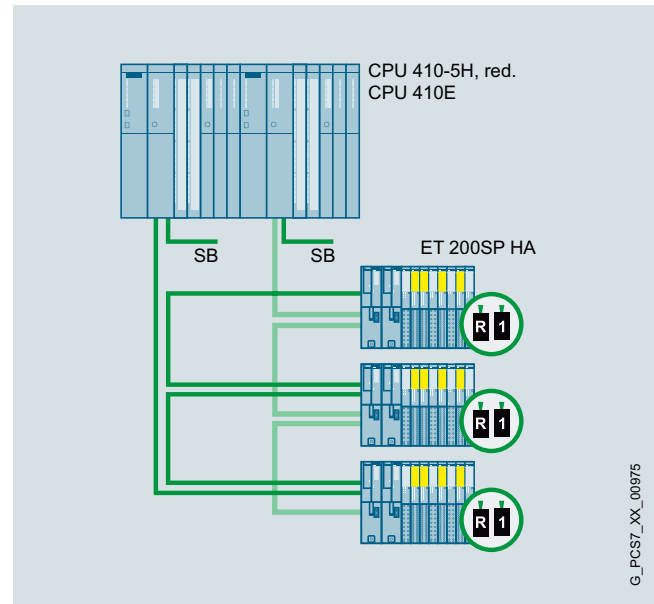

Safety-related PROFINET IO communication with system redundancy

Overview

Together with the SIMATIC S7 F Systems and SIMATIC Safety Matrix software, SIMATIC Safety Integrated supports the implementation and operation of safety applications for process automation.

Using the SIMATIC S7 F Systems engineering tool, you can configure the safety-related F/FH automation systems of the S7-400 series as well as the safety-related F-modules from the ET 200 range.

You can also configure the safety-related applications simply, efficiently and without any time-consuming familiarization using continuous function charts (CFC) and pre-defined function blocks from the F-block library of the SIMATIC S7 F systems. However, this is even simpler, more convenient and faster using the Safety Matrix Tool based on CFC. This tool works according to the principle of a Cause&Effect matrix. Once you have defined reactions (effects) to all events (causes) occurring during a process, the tool automatically produces complex safety programs.

The Safety Matrix Viewer allows you to operate and monitor the SIMATIC Safety Matrix from the SIMATIC PCS 7 OS single station or from the SIMATIC PCS 7 OS client.

SIMATIC PCS 7 system software

Safety Integrated for Process Automation

SIMATIC Safety Integrated

SIMATIC S7 fail-safe systems

Overview

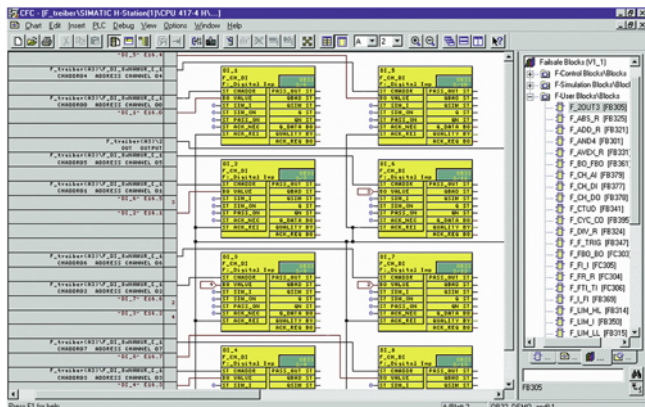

The SIMATIC S7 F Systems engineering tool for configuration of safety-related SIMATIC PCS 7 automation systems and safety-related F-modules from the ET 200 range is integrated in the SIMATIC Manager. SIMATIC S7 F Systems are based on pre-configured and German Technical Inspectorate certified blocks. The following functions are then available:

- Parameterization of CPU and F signal modules
- Creation of safety-related applications in the CFC

Design

Information on ordering and delivery

Installation software for the SIMATIC S7 F Systems is provided in the form of a software media package. Software media packages and product-specific software licenses are separate packages. They are not merged into a single delivery unit when supplied in package form.

The number of delivered software media packages can be determined by the number of ordered items. You can find additional information under "Delivery form package" in the "Software Media and Logistics", "PCS 7 Software Packages" section of the ST PCS 7 catalog.

Configuration

SIMATIC S7 F Systems supports configuration using functions for:

- Comparison of safety-related F-programs
- Recognition of changes in the F-program using the checksum
- Separation of safety-related and standard functions.

Access to the F functions can be password-protected.

The F-block library integrated in SIMATIC S7 F Systems contains pre-defined function blocks for generating safety-related applications with the CFC or the CFC-based SIMATIC S7 Safety Matrix. The certified F-blocks are extremely robust and intercept programming errors such as division by zero or out-of-range values. They avoid the need for diverse programming tasks for detecting and reacting to errors.

Notes:

- Depending on the software requirements of the SIMATIC PCS 7 version, SIMATIC S7 F Systems can be run under the following operating systems:
 - On the engineering station with Windows 7 SP1 64-bit (Professional, Enterprise, Ultimate) or Windows Server 2008 R2 SP1 Standard 64-bit, Windows 10 Enterprise 2015 LTSB 64-bit, Windows 10 Enterprise 2019 LTSC 64-bit, Windows Server 2012 R2 Update Standard Edition 64-bit, Windows Server 2016 Standard Edition 64-bit, Windows Server 2019 Standard Edition 64-bit
 - On the operator station (SIMATIC S7 F Systems HMI) with Windows 7 SP1 32-bit (Enterprise, Ultimate), Windows 7 SP1 64-bit (Professional, Enterprise, Ultimate), Windows 10 Enterprise 2015 LTSB 64-bit, Windows Server 2008 R2 SP1 Standard 64-bit or Windows Server 2012 R2 Standard 64-bit, Windows 10 Enterprise 2019 LTSC 64-bit, Windows Server 2012 R2 Update Standard Edition 64-bit, Windows Server 2016 Standard Edition 64-bit, Windows Server 2019 Standard Edition 64-bit
- The SIMATIC S7 F Systems RT license for processing safety-related user programs in the controller is already integrated in the "AS bundles" of the safety-related automation systems. The Article No. for ordering further licenses can be found in the section "Automation systems" under "Modular AS 410 systems", "Safety-related automation systems" and under "Complementary S7-400 systems".

Ordering data	Article No.	Article No.
SIMATIC S7 F Systems		
<p>SIMATIC S7 F Systems V6.3 Programming and configuration environment for creating and using safety-related STEP 7 programs</p> <p>2 languages (English, German), software class A</p> <p>Runs on the following operating systems:</p> <ul style="list-style-type: none"> Windows 10 Enterprise 2015 LTSB 64-bit, MS Windows 10 Enterprise 2019 LTSC 64-bit, MS Windows Server 2012 R2 Update Standard Edition 64-bit, MS Windows Server 2016 Standard Edition 64-bit, MS Windows Server 2019 Standard Edition 64-bit <p>Floating license for 1 user, without SIMATIC PCS 7 Software Media Package</p> <ul style="list-style-type: none"> Goods delivery License key on USB flash drive and Certificate of License, bundled with 1 × SIMATIC S7 F Systems Software Media Package per order item Online delivery License key download and online Certificate of License combined with SIMATIC S7 F Systems Software Media Package (software download and online Certificate of License) <u>Note:</u> Email address required 	<p>6ES7833-1CC36-0YA5</p> <p>6ES7833-1CC36-0YH5</p>	<p>SIMATIC S7 F Systems Software Media Package</p> <p>SIMATIC S7 F Systems Software Media Package V6.3 Installation software without license</p> <p>2 languages (English, German), software class A</p> <p>Runs on the following operating systems:</p> <ul style="list-style-type: none"> Windows 10 Enterprise 2015 LTSB 64-bit, MS Windows 10 Enterprise 2019 LTSC 64-bit, MS Windows Server 2012 R2 Update Standard Edition 64-bit, MS Windows Server 2016 Standard Edition 64-bit, MS Windows Server 2019 Standard Edition 64-bit <p>Without SIMATIC PCS 7 Software Media Package</p> <p><u>Note:</u> Can only be used in conjunction with a valid license.</p> <ul style="list-style-type: none"> Goods delivery Software on DVD and Certificate of License Online delivery Software download and online Certificate of License <u>Note:</u> Email address required! <p>6ES7833-4CC36-0YT8</p> <p>6ES7833-4CC36-0YG8</p>
<p>SIMATIC S7 F Systems V6.2 Programming and configuration environment for creating and using safety-related STEP 7 programs</p> <p>2 languages (English, German), software class A</p> <p>Runs on the following operating systems (see SIMATIC S7 F Systems V6.2 Readme for the latest information):</p> <ul style="list-style-type: none"> On the engineering station with Windows 7 SP1 64-bit (Professional, Enterprise, Ultimate) or Windows Server 2008 R2 SP1 Standard 64-bit On the operator station also with Windows 7 SP1 32-bit (Enterprise, Ultimate), Windows 10 Enterprise 2015 LTSB 64-bit or Windows Server 2012 R2 Standard 64-bit <p>Floating license for 1 user, without SIMATIC PCS 7 Software Media Package</p> <ul style="list-style-type: none"> Goods delivery License key on USB flash drive and Certificate of License, bundled with 1 × SIMATIC S7 F Systems Software Media Package per order item Online delivery License key download and online Certificate of License combined with SIMATIC S7 F Systems Software Media Package (software download and online Certificate of License) <u>Note:</u> Email address required 	<p>6ES7833-1CC26-0YA5</p> <p>6ES7833-1CC26-0YH5</p>	<p>SIMATIC S7 F Systems Software Media Package V6.2 Installation software without license</p> <p>2 languages (English, German), software class A</p> <p>Runs on the following operating systems (see SIMATIC S7 F Systems V6.2 Readme for the latest information):</p> <ul style="list-style-type: none"> On the engineering station with Windows 7 SP1 64-bit (Professional, Enterprise, Ultimate) or Windows Server 2008 R2 SP1 Standard 64-bit On the operator station also with Windows 7 SP1 32-bit (Enterprise, Ultimate), Windows 10 Enterprise 2015 LTSB 64-bit or Windows Server 2012 R2 Standard 64-bit <p>Without SIMATIC PCS 7 Software Media Package</p> <p><u>Note:</u> Can only be used in conjunction with a valid license.</p> <ul style="list-style-type: none"> Goods delivery Software on DVD and Certificate of License Online delivery Software download and online Certificate of License <u>Note:</u> Email address required! <p>6ES7833-4CC26-0YT8</p> <p>6ES7833-4CC26-0YG8</p>
		<p>Upgrades for SIMATIC S7 F Systems See "Upgrades for Safety Integrated for Process Automation" in section "Update/upgrade packages", "Updates/upgrades asynchronous to the PCS 7 version".</p> <p><u>Note:</u> With a SIMATIC S7 F Systems Upgrade from V5.x to V6.x, the type of SIMATIC S7 F Systems license changes from Single License to Floating License.</p>

SIMATIC PCS 7 system software

Safety Integrated for Process Automation

SIMATIC Safety Integrated

SIMATIC S7 Safety Matrix

Overview

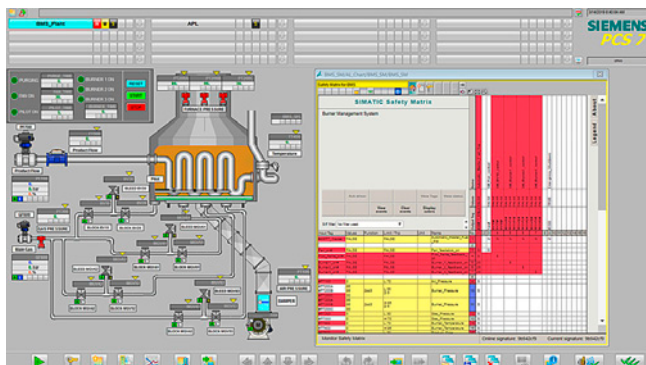

Process image of an operator station with the SIMATIC S7 Safety Matrix Viewer displayed

The SIMATIC S7 Safety Matrix, which can be used in addition to the CFC, is an innovative safety lifecycle tool from Siemens that can be used not only for user-friendly configuration of safety applications, but also for their operation and service. The tool, which is based on the proven principle of a cause & effect matrix, is ideally suited to processes where defined states require specific safety reactions.

The SIMATIC S7 Safety Matrix means that programming of the safety logic is not only significantly simpler and more convenient, but also much faster than conventional processes. During the risk analysis of a plant, the configuration engineer can assign precisely defined reactions (effects) to events (causes) which may occur during a process.

Benefits

Advantages of the SIMATIC S7 Safety Matrix in the implementation and operation phase

Implementation phase

- Direct further processing of safety specification possible
- Simple programming with the cause & effect method
- No programming knowledge required
- Preprocessing of input values
- Alarm generation and provision of diagnostic information for each individual cause & effect
- Prealarm for analog values
- Free color selection for alarms and messages
- Automatic generation of CFCs including driver blocks
- Matrix comparison on basis of created CFC charts
- Automatic version tracking
- integrated change tracking
- 1-to-1 expression of the cause & effect matrix

Operating phase

- Complete integration in SIMATIC PCS 7
- All relevant information can be seen at a glance in the template
- Cause & effect-dependent matrix and alarm display
- Tag display in the alarm
- Sequence of event display and saving
- First-up alarm display and saving
- Integral operating functions such as reset, override, and parameter modification
- Automatic saving of operating interventions for the safety life-cycle management
- Integral maintenance functions such as bypass and simulation
- Display of all relevant process values, also during maintenance
- Automatic version tracking
- Automatic documentation of modifications

Design

In the context of SIMATIC PCS 7, the following individual products are offered for the SIMATIC S7 Safety Matrix:

SIMATIC S7 Safety Matrix Tool

Designed for the SIMATIC PCS 7 Engineering System; for creating, configuring and compiling the SIMATIC S7 Safety Matrix, as well as for loading and operator control and monitoring of the safety-related CFC program.

The application covers the complete safety lifecycle, from analysis through implementation up to operation and maintenance.

SIMATIC S7 Safety Matrix Viewer

For the SIMATIC PCS 7 Operator System; for operator control and monitoring of the SIMATIC S7 Safety Matrix in the operating phase.

The SIMATIC S7 Safety Matrix Viewer can be installed on the SIMATIC PCS 7 Operator Station, Single Station or Client version to allow simple and intuitive operation and monitoring of the safety application during operation.

Information on ordering and delivery

Installation software for the SIMATIC S7 Safety Matrix is provided in the form of a software media package. Software media packages and product-specific software licenses are separate packages, which are not merged into a single delivery unit for a goods delivery.

The number of delivered software media packages can be determined by the number of ordered items. You can find more information under "Goods delivery" in the section "Software Media and Logistics", subsection "PCS 7 Software Packages" in the ST PCS 7 catalog.

Function

Input Tag	Values	Function	Limit / Trip	Unit	Name	Time	1	2	3	4	5	6	7	8	9	10	11	12	13	14	15
#AMFT_Cause			FALSE		Automatic_Master_Fu...	11	N	N	N	N	N	N	N	N	N	N	N	N	N	N	N
Fan_on			FALSE		Fan_feedback_on	12	S														
Pilot_fame_on			FALSE		Pilot_fame_feedback_on	14	S		S												
Burner_1_on			FALSE		Burner_1_feedback_on	16	S			S											
Burner_2_on			FALSE		Burner_2_feedback_on	18	S				S										
Burner_3_on			FALSE		Burner_3_feedback_on	20	S					S									
#PT100	L 70				Air_Pressure	19	S														
#PT200A	L 30				Burner_Pressure	10	S														
#PT200B	D 5				Burner_Pressure	11	S														
#PT200A	H 55				Gas_Pressure	12	S														
#PT200B	D 5				Gas_Pressure	13	S														
#PT300	L 30				Burner_Temperature	14	S														
#PT300	H 70				Burner_Temperature	15	S														
#TT400	L 70				Burner_Temperature	16	S														
#TT400	H 95				Burner_Temperature	17	S														
#FT500	L 30				Product_Flow	18	S														

SIMATIC S7 Safety Matrix: intersections define the linking of causes and effects

The matrix table is comparable with a spreadsheet program, and the project engineer first enters the possible process events (inputs) in the horizontal lines, and then configures their type and number, logical links, possible delays and interlocks, and any tolerable faults. The reactions (outputs) to a particular event are then defined in the vertical columns.

The events and reactions are linked by simply clicking the cell at the intersection of the row and column. Using these data, the SIMATIC S7 Safety Matrix automatically generates complex, safety-related CFC programs. The project engineer requires no special programming skills and can completely concentrate on the safety requirements of the plant.

Input window for configuration of analog "causes" with process value preprocessing

Each input value can be combined with a freely configurable preprocessing if necessary without giving up the simulation option.

The alarm management is supported by collective alarms, alarm prioritization and individually adjustable acknowledgement.

In addition to the alarms derived from process values, alarms can also be generated and diagnostics information can be provided for each individual cause and effect. Priorities and response behavior can be defined in various profiles here. The color scheme for the alarms and messages can be adapted on a customer- or country-specific basis.

For the Safety Life-cycle Management, functions are integrated for the version management and for the documentation of program changes and operator interventions.

During plant operation, the operator has direct access to the relevant data with the viewer of the SIMATIC S7 Safety Matrix. From the overall view it can change directly to cause or effect related detailed views and return from there. In the detailed views, alarm indications corresponding with the respective cause or effect can be called up.

Tag display in online mode with process value, simulation value and active value

The signal status is indicated online in the Cause & Effect matrix. The process value, simulation value and active value are indicated on the tag display in each case.

The SIMATIC S7 Safety Matrix viewer enables the operator to display and save initial messages, as well as to record safety-relevant events. Changes in parameters are supported, as are bypass, reset and override functions.

SIMATIC PCS 7 system software

Safety Integrated for Process Automation

SIMATIC Safety Integrated

SIMATIC S7 Safety Matrix**Ordering data****Article No.****Article No.****SIMATIC S7 Safety Matrix**

Runs with the following operating systems (see SIMATIC S7 Safety Matrix V6.3 Readme for the latest information):

- On engineering station under:
 - MS Windows 7 SP1 (64-bit) (Ultimate, Enterprise, Professional)
 - MS Windows 10 Enterprise 2015 LTSC
 - MS Windows 10 Enterprise 2019 LTSC
 - MS Windows Server 2008 R2 SP1
 - MS Windows Server 2012 R2 Standard
 - MS Windows Server 2016 Standard
 - MS Windows Server 2019 Standard
- On operator station (for Safety Matrix Viewer) under:
 - MS Windows 7 Ultimate SP1 (32-bit)
 - MS Windows 7 SP1 (64-bit) (Ultimate, Enterprise, Professional)
 - MS Windows 10 Enterprise 2015 LTSC
 - MS Windows 10 Enterprise 2019 LTSC
 - MS Windows Server 2008 R2 SP1
 - MS Windows Server 2012 R2 Standard
 - MS Windows Server 2016 Standard
 - MS Windows Server 2019 Standard

SIMATIC S7 Safety Matrix Tool V6.3

Creation, configuration, compilation and loading of the SIMATIC S7 Safety Matrix as well as operator control and monitoring in a SIMATIC PCS 7 environment
2 languages (German, English), software class A, floating license for 1 user

Without SIMATIC PCS 7 Software Media Package

- Goods delivery
License key on USB flash drive and Certificate of License, bundled with 1 × SIMATIC S7 Safety Matrix Software Media Package per order item
- Online delivery
License key download and online Certificate of License, combined with SIMATIC S7 Safety Matrix Software Media Package (software download and online Certificate of License)
Note: Email address required; installation software also available separately as SIMATIC S7 Safety Matrix Software Media Package.

6ES7833-1SM03-0YA5**6ES7833-1SM03-0YH5****SIMATIC S7 Safety Matrix Viewer V6.3**

For operator control and monitoring of the SIMATIC S7 Safety Matrix via OS Single Station/OS Client

Runtime software, 2 languages (German, English), software class A, floating license for 1 user

Without SIMATIC PCS 7 Software Media Package

- Goods delivery
License key on USB flash drive and Certificate of License, bundled with 1 × SIMATIC S7 Safety Matrix Software Media Package per order item
- Online delivery
License key download and online Certificate of License, combined with SIMATIC S7 Safety Matrix Software Media Package (software download and online Certificate of License)
Note: Email address required; installation software also available separately as SIMATIC S7 Safety Matrix Software Media Package.

6ES7833-1SM63-0YA5**6ES7833-1SM63-0YH5****SIMATIC S7 Safety Matrix Software Media Package****SIMATIC S7 Safety Matrix Software Media Package V6.3 (incl. SP)**

Installation software without license, 2 languages (German, English), software class A

Without SIMATIC PCS 7 Software Media Package

Note: Can only be used in conjunction with a valid license.

- Goods delivery
Software on DVD and Certificate of License
- Online delivery
Software download and online Certificate of License
Note: Email address required!

6ES7833-4SM36-0YT8**6ES7833-4SM36-0YG8****Upgrades for SIMATIC S7 Safety Matrix Tool and SIMATIC S7 Safety Matrix Viewer**

See "Upgrades for Safety Integrated for Process Automation", "Update/upgrade packages", "Updates/upgrades asynchronous to the PCS 7 version"

Technical specifications

	Safety lifecycle support	Operating modes	Hardware requirements	Software requirements
SIMATIC S7 Safety Matrix Tool V6.3	Complete lifecycle: <ul style="list-style-type: none"> • Analysis phase • Implementation phase • Operation and maintenance phase 	Offline, online	SIMATIC PCS 7 with safety-related automation systems (SIMATIC S7 F Systems RT license integrated) Installation basis: SIMATIC PCS 7 Engineering Station	<ul style="list-style-type: none"> • Microsoft Windows operating system (in line with the software requirements of the SIMATIC PCS 7 version) • For offline testing: S7-PLCSIM or SIMIT • SIMATIC S7 F Systems V6.1 SP2 and higher
SIMATIC S7 Safety Matrix Viewer V6.3	Operating phase (control and monitoring)	Online	SIMATIC PCS 7 with safety-related automation systems (SIMATIC S7 F Systems RT license integrated) Installation basis: SIMATIC PCS 7 Operator Station, single station or client version	Microsoft Windows operating system (in line with the software requirements of the SIMATIC PCS 7 version)

System requirements for SIMATIC S7 Safety Matrix

SIMATIC PCS 7 system software

Safety Integrated for Process Automation

Functional Safety Services

Overview

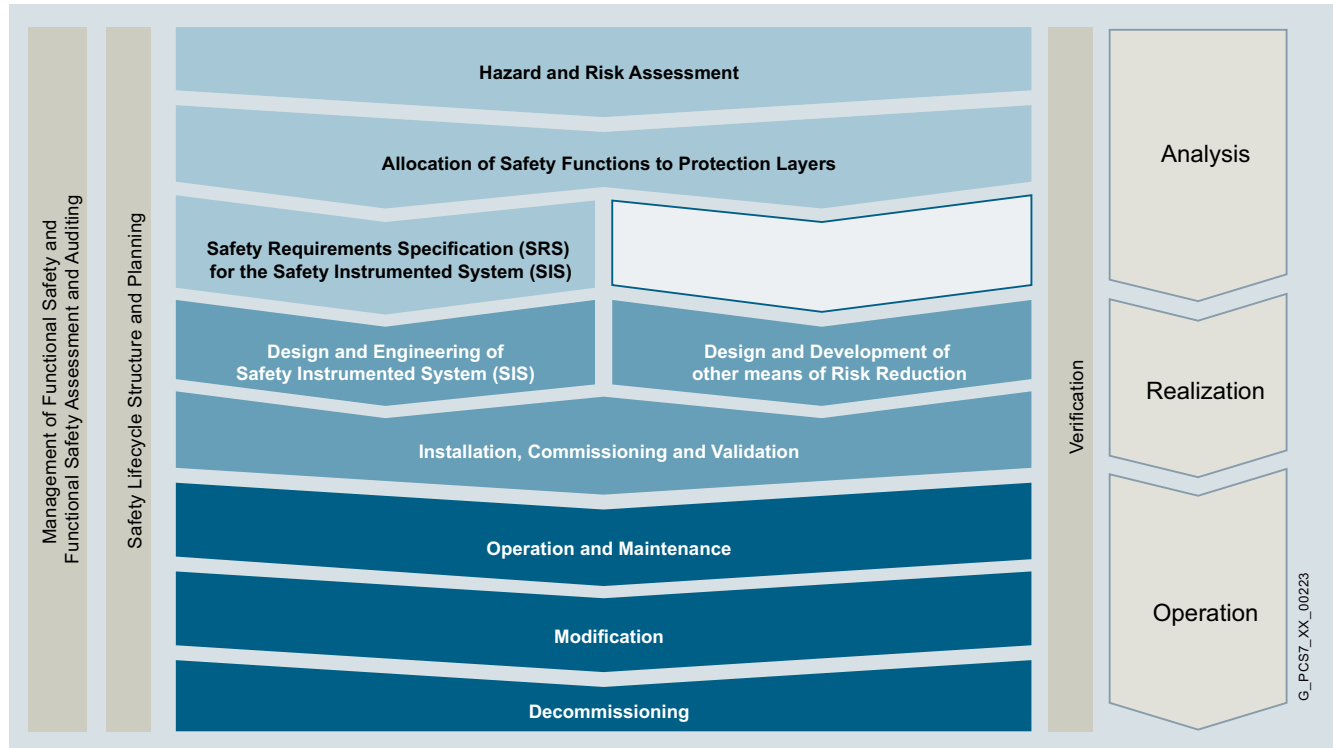

Simplified representation of the safety lifecycle (IEC 61511)

Safety lifecycle services for the process industry in accordance with IEC 61511

The area of functional safety covers much more than just the Installation SIL-certified hardware and software components. It requires expert knowledge, always aware of latest directives and technologies.

Plant operators, PLT protective devices for risk reduction - this includes operators of almost all chemical plants, refineries, distillation and combustion plants - must implement a system for management of functional safety. Operators are obliged to verify sufficient risk reduction.

In addition to the correct hardware and software, applied planning, operating, and change processes are decisive in ensuring that these systems effectively maintain their intended function throughout the complete lifecycle of the plant.

The basis for these processes are:

- Safety Life Cycle (SLC)
- Safety Integrity Level (SIL)

The safety lifecycle reflects the lifecycle of process plants and is divided into separate phases: Risk assessment, specification of the safety requirements, planning, installation and commissioning, operation, change as well as decommissioning. Errors in the early stages of the project can be often only be corrected later at great effort and cost. We systematically prevent errors in all project phases using our standardized engineering guidelines and verification templates.

Benefits

- Standardized processes for faster and safer project implementation and commissioning
- Uniform verification and validation documents
- Reduction of development time and costs through interdisciplinary team of experts with process and automation expertise
- Acceleration of the acceptance of plants by means of customized safety concepts

Application

- Plant operators that use PLT protective equipment to reduce risks - this includes the operators of almost all chemical plants, all refineries, distillation and combustion plants.
- SIMATIC PCS 7 plants with integrated safety technology using SIMATIC S7 F systems and the SIMATIC S7 Safety Matrix, and in which processing must be performed according to IEC 61511 or a specific safety integrity level (SIL).

Design***Our service offer***

- Management and evaluation of functional safety and audits
- Planning and configuration of the SLC (Safety Plan)
- Hazard and safety assessment
- Assignment of the safety functions to the protection levels
- Safety Requirement Specification (SRS)
- Verification and validation, e.g. SIL verification, hardware/software audit
- Modification (Management of Change)
- Training (see also <http://www.sitrain.com>)

More information

Siemens AG

Engineering & Consulting

Team-ec.industry@siemens.com

Tel.: +49 (69) 797-84500

More information is available on the Internet at:

<http://www.siemens.com/processsafety>

SIMATIC PCS 7 system software

Notes

10

Industrial Security



11/2	Network Security
11/6	Industrial Security Services
11/8	SIMATIC Logon

SIMATIC PCS 7 system software

Industrial Security

Network Security

Overview

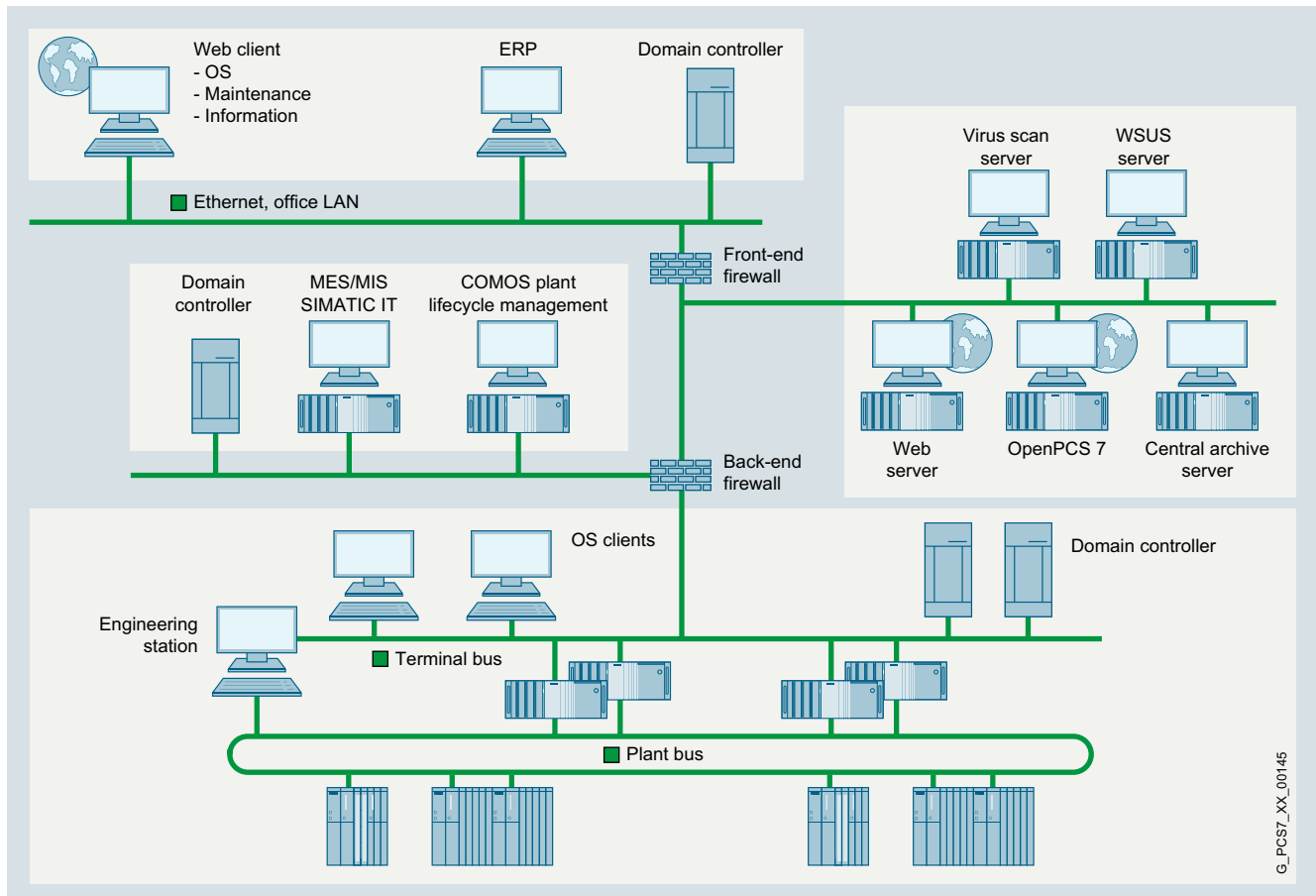

Example of a defense-in-depth security architecture

With advancing standardization, openness and networking, the security risks for process control systems have risen significantly. The danger potential arising from malicious programs such as computer viruses, worms and trojans or from access by unauthorized personnel ranges from network overloads or failures and theft of passwords and data to unauthorized interventions in the process automation. Apart from property damage, targeted sabotage can also have dangerous consequences for personnel and the environment.

With the security concept developed for SIMATIC PCS 7, you have comprehensive protection for your process control system against these various dangers. Siemens supports you with additional services as needed, including security assessment, security implementation and security management during operation (for details, see "Industrial Security Services" section).

SIMATIC PCS 7 security concept

The SIMATIC PCS 7 security concept, which is described in the "Security concept PCS 7 & WinCC (Basic)" manual and in detail in other documents, provides far-reaching recommendations (best practices) for safeguarding process plants based on a defense-in-depth security architecture. It is not restricted to the use of individual security methods (e.g. encryption) or devices (e.g. firewalls).

The strengths of this holistic concept lie rather in the interaction of a host of security measures in the plant network:

- Formation of a network architecture with defense-in-depth security, combined with segmenting of the plant into security cells
- Network administration, assignment of IP addresses, and division into subnetworks
- Operation of plants in Windows domains (active directory)
- Administration of Windows operator authorizations and SIMATIC PCS 7 operator authorizations; integration of SIMATIC PCS 7 operator authorizations into the Windows administration
- Reliable control of time synchronization
- Management of security patches for Microsoft products
- Use of virus scanners, whitelisting software and firewalls
- Establishment and operation of support access and remote access (VPN, IPSec)

The manual "PCS 7 & WinCC security concept, basic document" is available from the Siemens Industry Online Support:

<https://support.industry.siemens.com/cs/ww/en/view/26462131>

Design

On the system side, SIMATIC PCS 7 supports implementation of guidelines and recommendations of the security concept by:

- The compatibility statement with anti-virus software can be found in the compatibility tool:
<https://support.industry.siemens.com/kompatool/pages/main/index.jsf>
- Use of the local Windows firewall
- Automatic setting of safety-related parameters during setup, e.g. in DCOM, registry and Windows firewall
- Operator administration and authentication using SIMATIC Logon (for details, see "SIMATIC Logon" section)
- Integration of the Industrial Security Appliance SCALANCE SC-600
- Automation Firewall NG (Next Generation):
<https://mall.industry.siemens.com/mall/en/b1/Catalog/Products/10354142?tree=CatalogTree>
- Application whitelisting



SCALANCE S Industrial Security Appliance

SCALANCE SC Industrial Security Appliances

The SCALANCE S Industrial Security Appliances are used for protecting devices and networks in automation engineering and industrial communication. They are distinguished, for example, by the following features:

- Implementation of a cell protection concept and support in implementing the Siemens Defense in Depth security concept
- Checking and filtering of data traffic by integrated firewall and thus:
 - Protection against operator mistakes
 - Prevention of unauthorized access
 - Prevention of faults and communications overload
- Authentication of communication partners and encryption of transmitted data via VPN, thus protecting communication against espionage and manipulation
- Rugged, industry-compatible device design
- Easy and clear configuration:
The TIA Portal can be used to configure and diagnose all SIMATIC NET security products from a central point
- Protocol-agnostic communication security (e.g. independent of PROFINET or other Ethernet-based fieldbus solutions)
- Secure remote access via the Internet possible with any provider

Product versions:Industrial Firewall Appliances:SCALANCE SC622-2C;

- Used for network separation according to PROFIsafe in order to make PROFIsafe address easier to manage
- Uses stateful inspection firewall to protect network segments against unauthorized access
- Connection via 2x combo port, electrical with RJ45 (10/100/1 000 Mbps) or optical via SFPs (1 000 Mbps)
- Firewall data throughput up to 600 Mbps
- Connection to SINEMA Remote Connect via VPN

SCALANCE SC632-2C;

- Uses stateful inspection firewall to protect network segments against unauthorized access
- Connection via 2x combo port, electrical with RJ45 (10/100/1 000 Mbps) or optical with SFPs (100 Mbps or 1 000 Mbps)
- Firewall data throughput up to 600 Mbps
- Connection to SINEMA Remote Connect via VPN

SCALANCE SC636-2C;

- Uses stateful inspection firewall to protect network segments against unauthorized access
- Connection via 4x port, electrical with RJ45 (10/100/1 000 Mbps) and 2x combo port, electrical with RJ45 (10/100/1 000 Mbps) or optical with SFPs (100 Mbps or 1 000 Mbps)
- Firewall data throughput up to 600 Mbps
- Connection to SINEMA Remote Connect via VPN

Industrial VPN Appliances:SCALANCE SC642-2C;

- Uses stateful inspection firewall to protect network segments against unauthorized access
- Simultaneous operation of up to 200 VPN tunnels possible
- Connection via 2x combo port, electrical with RJ45 (10/100/1 000 Mbps) or optical with SFPs (100 Mbps or 1 000 Mbps)
- Firewall data throughput up to 600 Mbps
- VPN data throughput up to 120 Mbps
- Connection to SINEMA Remote Connect via VPN

SCALANCE SC646-2C;

- Uses stateful inspection firewall to protect network segments against unauthorized access
- Simultaneous operation of up to 200 VPN tunnels possible
- Connection via 4x port, electrical with RJ45 (10/100/1 000 Mbps) and 2x combo port, electrical with RJ45 (10/100/1 000 Mbps) or optical with SFPs (100 Mbps or 1 000 Mbps)
- Firewall data throughput up to 600 Mbps
- VPN data throughput up to 120 Mbps
- Connection to SINEMA Remote Connect via VPN

SIMATIC PCS 7 system software

Industrial Security

Network Security

Design (continued)

Note:

Configuration is carried out using the TIA Portal. This means that all SIMATIC NET security products can be configured and diagnosed from a central point. All the configuration data can be saved on the optional C-plug removable data storage medium (not included in scope of supply) so that the Industrial Security Appliance can be replaced quickly in the event of a fault and without the need for a programming device.

Configuration using Web Based Management (WBM), Command Line Interface (CLI) or SNMP in addition to configuration via TIA Portal.

Automation Firewall NG

The Automation Firewall NG from Siemens (see Catalog ST PCS 7 AO, "Industrial Security Services" section) is a tested and validated standard firewall available in three performance classes (220, 820, and 850). It has been tuned for use with SIMATIC PCS 7 and WinCC.

The Automation Firewall NG works excellently with SIMATIC NET communication products. It features comprehensive hardware and software functions for SIMATIC PCS 7 and WinCC projects, e.g.:

- Application layer / Stateful inspection firewall
- IPSec VPN gateway
- Intrusion detection system
- Antivirus (optional add-on)
- Based on Palo Alto Networks Next Generation Firewalls
- Palo Alto Networks is the "Gartner Magic Quadrant Leader" for Enterprise Network Firewalls for the eighth time in succession
- Threat prevention (additional order necessary)
- Advanced malware protection (additional WildFire order necessary)
- File and data filtering
- Protection against known and unknown threats
- High availability (active/active and active/passive)
- Redundant power supply for increased availability (PA-220 and PA-850)
- Fanless design (PA-220)

The Palo Alto Networks firewall has multiple advantages compared with conventional firewalls, e.g.:

- Excellent price/performance ratio
- Robust operating system (PanOS based on Linux)
- Hardware-based (instead of software)
- Secure system architecture
- The NGFW device consists of a dedicated management level and a data control level which ensure that handling is not impaired by the network load.
- Firmware (bundle comprising OS and FW software: one update for both)
- Detects Layer 7 traffic, e.g. an S7 protocol (detects: start, stop, read, write)
- Numerous application protocols are recognized within the box – making time savings possible

Depending on the plant configuration and size, the Automation Firewall NG is the preferred choice for:

- Three-homed firewalls for small to medium-sized plants with "minimal perimeter networks"
- Front and back firewalls for maximum protection in larger plants with extensive perimeter networks

Ordering data

Article No.

Article No.

SCALANCE S**Industrial Security Appliances**

For protecting devices and networks in discrete manufacturing and the process industry used for securing industrial communication; Industrial Security Appliances protect network segments against unauthorized access using a Stateful Inspection Firewall; choice of 10/100/1 000 Mbps ports for connection; electronic manual on DVD; English, German

SCALANCE SC622-2C

Industrial Security Appliance; for protecting devices and networks in discrete manufacturing and the process industry for securing industrial communication with firewall. Additional functions: Address translation (NAT/NAPT); 2x combo port, electrical with RJ45 (10/100/1 000 Mbps) or optical with SFPs (1 000 Mbps); hardware separation of ports; integrated SINEMA RC device license

SCALANCE SC632-2C

Industrial Security Appliance; for protecting devices and networks in discrete manufacturing and the process industry for securing industrial communication with firewall. Additional functions: Address translation (NAT/NAPT); 2x combo port, electrical with RJ45 (10/100/1 000 Mbps) or optical with SFPs (100 Mbps or 1 000 Mbps); integrated SINEMA RC device license

SCALANCE SC636-2C

Industrial Security Appliance; for protecting devices and networks in discrete manufacturing and the process industry for securing industrial communication with firewall. Additional functions: Flexible security zones, address translation (NAT/NAPT); 4x electrical with RJ45 (10/100/1 000 Mbps) and 2x combo port, electrical with RJ45 (10/100/1 000 Mbps) or optical with SFPs (100 Mbps or 1 000 Mbps); integrated SINEMA RC device license

SCALANCE SC642-2C

Industrial Security Appliance; for protecting devices and networks in discrete manufacturing and the process industry for securing industrial communication with firewall and VPN. Additional functions: Address translation (NAT/NAPT); 2x combo port, electrical with RJ45 (10/100/1 000 Mbps) or optical with SFPs (100 Mbps or 1 000 Mbps); integrated SINEMA RC device license

6GK5622-2GS00-2AC2

6GK5632-2GS00-2AC2

6GK5636-2GS00-2AC2

6GK5642-2GS00-2AC2

SCALANCE SC646-2C

Industrial Security Appliance; for protecting devices and networks in discrete manufacturing and the process industry for securing industrial communication with firewall and VPN. Additional functions: Flexible security zones, address translation (NAT/NAPT); 4x electrical with RJ45 (10/100/1 000 Mbps) and 2x combo port, electrical with RJ45 (10/100/1 000 Mbps) or optical with SFPs (100 Mbps or 1 000 Mbps); integrated SINEMA RC device license

Accessories**C-PLUG**

Removable data storage medium for simple replacement of devices in event of fault; for saving of configuration and application data, can be used in SIMATIC NET products with C-PLUG slot

SITOP compact 24 V/0.6 A

Single-phase power supply with wide-range input 85 to 264 V AC; 110 to 300 V DC; stabilized output voltage 24 V, rated output current value 0.6 A, slim design

Automation Firewall NG

For ordering data for automation firewall and service contracts, see Catalog ST PCS 7 AO (Add-ons for the SIMATIC PCS 7 Process Control System), "Industrial Security Services" section

6GK5646-2GS00-2AC2

6GK1900-0AB00

6EP1331-5BA00

Note:

For more components and accessories, especially cable material and connectors, as well as tools and supplementary material for assembly, see "Industrial Communication - Industrial Ethernet - Passive network components" in the sections "FastConnect", "ITP Cables and Connectors" and "Fiber-Optic Cables" as well as Catalog IK PI.

More information

Siemens provides automation and drive products with industrial security functions that support the secure operation of plants or machines. They are an important component in a holistic industrial security concept. With this in mind, our products undergo continuous development. We therefore recommend that you keep yourself informed with respect to our product updates. Please find further information and newsletters on this subject at: <http://support.automation.siemens.com>

To ensure the secure operation of a plant or machine it is also necessary to take suitable preventive action (e.g. cell protection concept) and to integrate the automation and drive components into a state-of-the-art holistic industrial security concept for the entire plant or machine. Any third-party products that may be in use must also be taken into account. Please find further information at:

<http://www.siemens.com/industrialsecurity>

SIMATIC PCS 7 system software

Industrial Security

Industrial Security Services

Overview



Infected devices, unauthorized personnel, unauthorized access via networks and the Internet now threaten more than just the administrative level. Even production facilities are exposed to constant danger from disruptions, integrity impairment and know-how loss.

Many weak spots in security are not obvious at first glance. That is why continuous analysis and optimization of security in existing plants is advisable. Only in this way can plant availability be kept at a consistently high level.

Siemens offers you wide-ranging support with integrated Industrial Security Services for a holistic solution.

Security Consulting

Security Consulting includes comprehensive analysis of threats, identification of risks and the recommendation of specific security measures. Your benefit: A plant-specific and risk-based security map ensures an integrated and optimal security level.

Security Implementation

Security Implementation means the introduction of security measures to increase the security level of plants and production sites. Your benefit: Avoid security vulnerability and profit from better protection from cyber threats thanks to technical and organizational measures.

Security Optimization

Security Optimization means regular monitoring and updating of the implemented measures. Your benefit: You get maximum transparency on the security status of your plants and proactive prevention of potential threat scenarios.

Ordering data

Article No.

Security Consulting	
Industrial Security Check Quick overview about the current security status of the plant without a deep time investment	9AS1411-4AA11-1AA1
IEC 62443 Assessment Available for systems from Siemens and third-party suppliers	9AS1411-3AA11-1AA1
• Additional cell for IEC 62443 assessment	9AS1411-3AA11-2AA1
ISO 27001 Assessment Available for systems from Siemens and third-party suppliers	9AS1411-1AA11-1AA1
Risk & Vulnerability Assessment • Data-based analysis of threats, weaknesses and gaps • Risk classification and evaluation taking system criticality into consideration	9AS1431-1AA11-1AB1
Scanning Services - Asset Identification Scan Rapid transparency on implemented assets and software versions in automation environment	9AS1411-5AA11-1AA1
Scanning Services - Vulnerability Detection Scan Rapid transparency over current vulnerabilities with mitigation proposals in automation environments	9AS1411-6AA11-1AA1
Industrial Security Consulting Introduction of new and tested security-relevant standards, guidelines and processes for plant security	9AS1432-1AA11-1AB1
Security Implementation	
Security awareness training • Web-based SITRAIN training courses • Heighten security awareness of plant personnel regarding current situation and in handling threats and risks, detection of security incidents	On request
Automation firewall installation Installation, configuration and testing of the firewall as well as the firewall rules, Next Generation Firewalls from Palo Alto Networks, see Catalog ST PCS 7 AO, section "Industrial Security Services"	9AS1433-1AA11-1AB3
Antivirus installation Installation and configuration of McAfee VirusScan Enterprise antivirus software; compatibility consideration for SIMATIC PCS 7	9AS1432-1AA11-1AB7
Whitelisting installation Installation and configuration of McAfee Application Control whitelisting software; compatibility consideration for SIMATIC PCS 7	9AS1432-1AA11-1AB8
ePO Management server deployment Installation of a McAfee ePO central management console (recommended by more than 10 antivirus or whitelisting agents)	9AS1433-1AA11-1AB1

Ordering data	Article No.	Article No.
McAfee		
<u>McAfee Application Control (AC) client bundle - LTS¹⁾</u> Whitelisting license for Windows client operating system, e.g. Windows 10; incl. updates by McAfee and long-term support from Siemens	9AS1425-2AA11-1BG1	
<u>McAfee Application Control (AC) server bundle - LTS¹⁾</u> Whitelisting license for Windows Server operating system, e.g. Windows Server 2016; incl. updates by McAfee and long-term support from Siemens	9AS1425-2AA11-1BH1	
<u>McAfee Virus Scan Enterprise (VSE) client bundle - LTS¹⁾</u> Antivirus license (earlier version, standalone) for Windows client operating system, e.g. Windows 7; incl. updates by McAfee and long-term support from Siemens	9AS1425-2AA11-1CA1	
<u>McAfee Virus Scan Enterprise (VSE) server bundle - LTS¹⁾</u> Antivirus license (earlier version, standalone) for Windows Server operating system, e.g. Windows Server 2012; incl. updates by McAfee and long-term support from Siemens	9AS1425-2AA11-1CC1	
<u>McAfee Endpoint Security (ENS) client bundle - LTS¹⁾</u> Antivirus license (included in the new software suite) for Windows client operating system, e.g. Windows 10; incl. updates by McAfee and long-term support from Siemens	9AS1425-2AA11-1CE1	
<u>McAfee Endpoint Security (ENS) server bundle - LTS¹⁾</u> Antivirus license (included in the new software suite) for Windows Server operating system, e.g. Windows Server 2016; incl. updates by McAfee and long-term support from Siemens	9AS1425-2AA11-1CF1	
Security Optimization		
Industrial Anomaly Detection Detecting all assets in industrial environments, in combination with oversight of all communications. Identification of anomalies.		
• Industrial Anomaly Detection Small	9AS1427-1AA11-1AA1	
• Industrial Anomaly Detection Medium	9AS1427-1AA11-1AB1	
• Industrial Anomaly Detection Large	9AS1427-1AA11-1AC1	
• Industrial Anomaly Detection Sensor	9AS1427-1AA11-1AD1	
• Industrial Anomaly Detection 100 Token	9AS1427-1AA11-1AE1	
Maintenance & Support (M&S)		
• Industrial Anomaly Detection Small M&S	9AS1427-1AA11-1BA1	
• Industrial Anomaly Detection Medium M&S	9AS1427-1AA11-1BB1	
• Industrial Anomaly Detection Large M&S	9AS1427-1AA11-1BC1	
• Industrial Anomaly Detection Sensor M&S	9AS1427-1AA11-1BD1	
• Industrial Anomaly Detection Additional 100 Token M&S	9AS1427-1AA11-1BE1	
Asset Vulnerability Analysis	9AS1427-1AA12-1AA2	
		Industrial Security Monitoring On request
		• Continuous monitoring of plant security • Continuous analysis and correlation of the log files as well as synchronization with "Global Threat Intelligence" databases • Recognition, classification as well as notification upon detection of security threats and potential incidents
		Remote incident handling Quick response as well as cause and criticality analysis by Siemens Industrial Security experts
		Industrial Vulnerability Manager (IVM) Automatic security notifications and bulletins for the monitored components and devices
		• IVM – Solution for end customers based on MindSphere 9AS1433-1AA13-1AA1
		• IVM – Solution for end customers based on AWS 9AS1433-1AA13-1AC1
		• IVM – Solution for end customers on premises 9AS1433-1AA13-1AB1
		• IVM – Solution for end customers on Siemens Industrial Edge 9AS1433-1AA13-1AD1
		• IVM – Setup/Bundling for end customers 9AS1433-1AA13-2AA1
		• IVM – Solution for OEMs based on MindSphere 9AS1433-1AA13-1BA1
		• IVM – Setup for OEMs based on MindSphere 9AS1433-1AA13-2AA2
		• IVM – New component request 9AS1433-1AA13-1AA4
		Patch management Central WSUS Server with information about Microsoft Security patches released for SIMATIC PCS 7
		9AS1433-1AA11-1AB5
		SIMATIC Security Service Packages
		<u>For end customers:</u>
		• Managed Hardening SIMATIC S7-1500 small (1-5 PLCs) 9AS1433-2AA11-3AA1
		• Managed Hardening SIMATIC S7-1500 medium (6-15 PLCs) 9AS1433-2AA11-3AA2
		• Managed Hardening SIMATIC S7-1500 large (16+ PLCs) 9AS1433-2AA11-3AA3
		• Vulnerability Notification Service 9AS1433-2AA11-1AA1
		<u>For machine builders:</u>
		• Security Consulting for Machines 9AS1433-2AA11-5AA1
		• Vulnerability Notification Service 9AS1433-2AA11-4AA1
		¹⁾ In addition to the software licenses, the bundles also include updates as long as provided by McAfee and long-term support (LTS) through the Siemens Hotline without annual maintenance fees. ENS is the successor of VSE and includes the antivirus functionality.
		More information
		You can find further information on the Industrial Security Services on the Internet: http://www.siemens.com/industrial-security-services
		If you have any further questions, please contact: Email: industrialsecurity.i@siemens.com

SIMATIC PCS 7 system software

Industrial Security

SIMATIC Logon

Overview

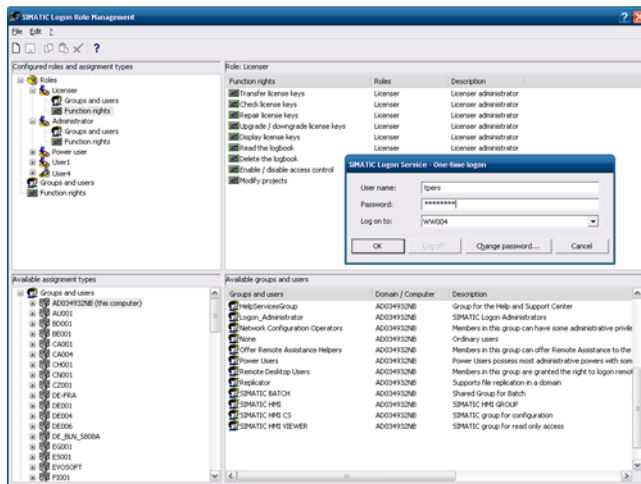

SIMATIC Logon role management

Centralized user administration with access control and electronic signature

SIMATIC Logon is a centralized user administration system with access control that also supports an electronic signature. It is in a position to work with applications in which roles have already been created or can be defined.

SIMATIC Logon facilitates the validation of plants in compliance with FDA 21 CFR Part 11.

Application

The SIMATIC Logon V1.6 software package is released for the following systems:

- SIMATIC PCS 7 Process Control System V8.0, V8.1, V8.2, V9.0 and V9.1
- SIMATIC WinCC V7.0+SP3, V7.2, V7.3, V7.4 and V7.5
- SIMATIC WinCC Runtime Professional Edition V13 and V14

Further application examples in the SIMATIC environment include:

- SIMATIC STEP 7 V5.5+SP4
- SIMATIC WinCC flexible from Version 2007 in conjunction with Logon Remote Access
- SIMATIC WinCC Runtime Advanced Edition V13 in conjunction with Logon Remote Access

SIMATIC Logon can also easily be integrated in other applications based on a programming example (Development Kit).

Note:

The products listed here in the ordering data are not relevant for SIMATIC PCS 7 V8.2, V9.0 and V9.1! SIMATIC Logon software and licenses are already integrated in the system software of SIMATIC PCS 7 Process Control System V8.2, V9.0 and V9.1.

Design

Logon devices

The following logon devices are supported by SIMATIC Logon:

- Keyboard
- Smart card reader (see "SIMATIC Industrial Workstation/IPC" section under "Expansion components")
- Logon devices which can be operated with a Microsoft device driver for the respective operating system, e.g. logon devices on a USB interface

Number of licenses

If SIMATIC Logon is not integrated on the system side, you require the same number of SIMATIC Logon licenses as the number of Clients/Single Stations accessing the application for which SIMATIC Logon is used as access protection.

SIMATIC Logon Upgrade

All previous versions can be upgraded to the current version.

Function

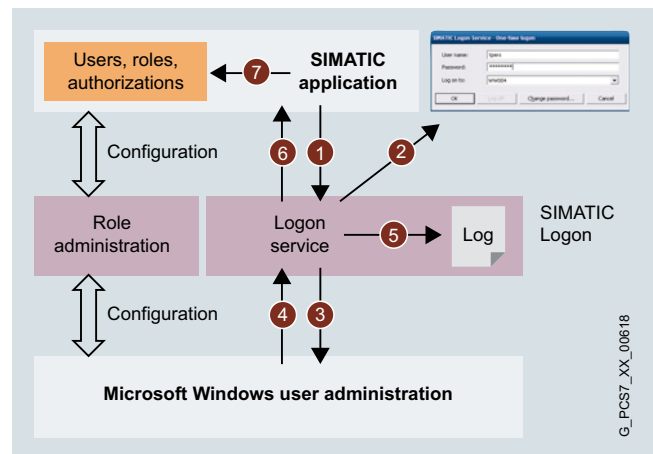

User logon procedure using the SIMATIC Logon Service.

SIMATIC Logon can be used to configure the associated roles and functional authorizations (role management) for a SIMATIC application. This configuration is stored in the database of the SIMATIC application.

SIMATIC Logon performs Windows user authentication during application runtime; the procedure is as follows:

- When prompted by a SIMATIC application (1), the SIMATIC Logon Service opens a logon dialog (2). The user enters his or her name, password and domain. The logon data are sent to the user administration of the operating system (3), which then reports the authentication attempt event to the logon service (4).
- The logon service records all events in an event log (5), for example successful logon, failed logon attempts, logoff by the user, automatic logoff and password change.
- If authentication is successful, the SIMATIC Logon Service sends this information, including the Windows group membership, to the SIMATIC application (6), which maps the roles and associated functional rights within the application (7).

G_PCS7_XX_00618

Function (continued)**Electronic signature**

The electronic signature means that operations cannot be performed until enabled by a previously authorized user. Authorization is assigned in the application by associating the users grouped at operating system level with the group with the operations.

Note:

At the moment this function is implemented as a system function only on SIMATIC BATCH. The electronic signature can, however, also be flexibly implemented for specific applications.

Development Kit

The Development Kit uses an example to show the programmer how to embed SIMATIC Logon into a customer application.

Ordering data	Article No.	Article No.
For TIA applications only		
SIMATIC Logon V1.6 Single license for 1 installation, 7 languages (English, German, French, Italian, Spanish, Chinese, Japanese), software class A Runs with the following operating systems: <ul style="list-style-type: none"> • Windows Vista (Business/Enterprise/Ultimate) up to SP2 32/64-bit • Windows 7 (Professional/Enterprise/Ultimate) up to SP1 32/64-bit • Windows 8.0 (Standard/Pro/Enterprise) 32/64-bit • Windows 8.1 (Standard/Pro/Enterprise) 32/64-bit • Windows 10 (Professional/Enterprise) 2016 LTSB 64-bit • Windows Server 2003 SP1/SP2 32-bit • Windows Server 2003 R2/2003 R2 SP2 32-bit • Windows Server 2008 (Standard/Enterprise/Datacenter) up to SP2 32/64-bit • Windows Server 2008 R2 (Standard/Enterprise/Datacenter) up to SP1 64-bit • Windows Server 2012 (Foundation/Essentials/Standard/Datacenter) 64-bit • Windows Server 2012 R2 (Essentials/Standard/Datacenter) 64-bit • Windows Server 2016 • Windows Server 2019 Goods delivery: Software and electronic documentation on CD, license key on USB flash drive, Certificate of License Note: This product is not intended for SIMATIC PCS 7 applications!	6ES7658-7BX61-0YA0	Supplementary components for SIMATIC Logon with SIMATIC WinCC flexible and WinCC TIA Portal
		SIMATIC Logon Remote Access (3 clients) Remote access for 3 clients (configured with WinCC flexible Version 2007 and higher or WinCC TIA Portal), single license for 1 installation Goods delivery: License key USB flash drive, Certificate of License
		SIMATIC Logon Remote Access (10 clients) Remote access for 10 clients (configured with WinCC flexible Version 2007 and higher or WinCC TIA Portal), single license for 1 installation Goods delivery: License key USB flash drive, Certificate of License
SIMATIC Logon upgrade to V1.6 Single license for 1 installation, 7 languages (English, German, French, Italian, Spanish, Chinese, Japanese), software class A For operating systems, see above Goods delivery: Software and electronic documentation on CD, license key on USB flash drive, Certificate of License Note: This product is not intended for SIMATIC PCS 7 applications!	6ES7658-7BX61-0YE0	

SIMATIC PCS 7 system software

Notes

11

Process Control System IPC



12/2	Introduction
12/3	SIMATIC Rack PC
12/5	IPC647E
12/11	IPC847E
12/18	SIMATIC Microbox PC
12/20	OS Client IPC427E
12/22	OS Client IPC477E
12/24	Expansion components
12/24	Mouse and keyboard
12/27	Smart card reader
12/28	Input tools

SIMATIC PCS 7 system hardware

Process Control System IPC

Introduction

Overview

We offer a select range of modern and powerful SIMATIC Process Control System IPCs for the system architecture located above the controller level in the SIMATIC PCS 7 system architecture, e.g. for:

- Engineering
- Operator control and monitoring (also via Internet/intranet)
- Asset management
- Batch automation
- Route control
- Remote control
- IT applications

SIMATIC Process Control System IPCs based on a SIMATIC Rack PC of the type IPC 647E or IPC 847E are optimized for use as single station, server or client, and can be expanded in line with the system.

As a supplement, the SIMATIC Microbox PC in the SIMATIC Process Control System Client IPC427E / IPC477E version provides low-cost client alternatives for operator control and monitoring and for batch automation.

Application

Basic hardware for single station/server

SIMATIC Process Control System IPCs of type IPC 647E or IPC 847E, which are available for use as single stations or servers, vary in their power, features, expansion spares, and length of product lifecycle. A table compares the essential features of these types in the catalog section "SIMATIC Rack PC, introduction", allowing you to quickly narrow down the search for your specific application. You can then use the detailed technical data in the same catalog section to define this preselection in detail.

Basic hardware for clients

Compared to the more compact SIMATIC Process Control System Client IPC427E / IPC477E client versions, clients based on a SIMATIC Rack PC have a larger number and greater variety of interfaces. They therefore offer more expansion options and can be used more universally. In multi-monitor mode, you can control up to four process monitors with equivalent quality.

The main advantage of the SIMATIC Process Control System Clients IPC427E / IPC477E is their highly compact and rugged design which allows continuous 24/7 maintenance-free operation without fans. These clients are particularly resistant to vibration and shock in the version with solid-state drive (SSD) because there are no rotating storage media. The Process Control System Client IPC427E is a computing unit without monitor in a compact metal enclosure. The SIMATIC Process Control System Client IPC477E was designed as built-in unit with a 22" TFT Touch Panel and integrated computing unit. The expansion options for both devices are limited due to their design.

Options

Notes on the use of other basic hardware and non-SIMATIC software

Siemens guarantees the compatibility of hardware and software for system configurations based on components in this catalog.

The system test confirms that the system software of the SIMATIC PCS 7 process control system can be run on the basic hardware offered in this catalog. Despite comprehensive tests, it cannot be excluded that the function of a SIMATIC PCS 7 system could be disturbed or interfered with as a result of additional non-SIMATIC software, i.e. software which has not been explicitly approved for SIMATIC PCS 7.

If you use hardware other than the basic hardware offered in this catalog, or additional non-SIMATIC software, this is at your own risk. If compatibility problems arise as a result of these hardware/software components, the support provided for their elimination is not free of charge.

The licenses for plant bus communication via Industrial Ethernet, i.e. for Basic Communication Ethernet (BCE) and CP 1623/1628 communication (IE), are bound to the SIMATIC Process Control System IPCs. Depending on the selected type of communication, the SIMATIC Process Control System IPCs for Single Stations and Servers are delivered as standard with a network adapter plus BCE license or a CP 1623 plus SIMATIC NET HARDNET IE S7 communication software.

SIMATIC PCS 7 BCE V9.1 license

If you are using SIMATIC PCS 7 V9.1 on other computers (not SIMATIC Process Control System IPC), you also require a SIMATIC PCS 7 BCE V9.1 license (Article No. 6ES7650-1CD68-2YB5 for goods delivery; Article No. 6ES7650-1CD68-2YH5 for online delivery) for all Single Stations or Servers that are connected to the plant bus via a standard network adapter and not via a CP 1623/CP 1628.

Overview





SIMATIC IPC647E and IPC847E

The SIMATIC Process Control System IPC is an excellent platform for the configuration of single stations, servers and clients. With their all-round capabilities they are ideally equipped for numerous applications in process automation.

Since the basic components such as chip set, processor and work memory are identical, many technical specifications of the IPC647E and IPC847E are comparable. The essential differences result from the different overall heights. Since the IPC647E is only half as high as IPC847E, the number and variety of free slots are reduced. On the other hand, the more compact design requires significantly less space and enables higher packing densities in the control cabinet. This allows the realization of space-saving designs.

The IPC847E is the most powerful and best equipped SIMATIC Process Control System IPC. Its numerous and varied slots provide a great deal of potential for expansion. The IPC847E is predestined for use as a server or single station. Since it would be over-dimensioned as a client, IPC847E is not offered in this version.

Application

Features		SIMATIC Process Control System IPC	
		IPC647E	IPC847E
			
Available SIMATIC PCS 7 pre-installations	V9.1	●	●
Available versions	ES/OS single station	●	●
	OS Server	●	●
	OS Client	●	●
Height		2 U	4 U
ECC work memory		●	●
Onboard RAID controller	RAID 1 (SATA HDD)	●	●
	RAID 1 (SATA SSD)	●	●
	RAID 5 (SATA SSD)	–	●
Hardware RAID controller (PCI x8)	RAID 1 (SAS HDD)	●	●
	RAID 5 (SAS HDD)	–	●
Hard disks or solid state drives (SSD)	SATA/SAS HDD	●/●	●/●
	SATA SSD	●	●
	M.2 NVMe SSD	●	●
Redundant power supply	With diagnostics	●	●
	Without diagnostics	–	–
Lifecycle	Marketing	5 years	5 years
	Spare parts/repair	5 years	5 years

SIMATIC PCS 7 system hardware

Process Control System IPC

SIMATIC Rack PC

Application (continued)

Specially optimized versions are available for operation as single stations, servers or clients. The operating system and the following ES/OS software of the SIMATIC PCS 7 process control system are factory installed:

- Single station: PCS 7 Engineering Software for AS/OS (including OS Runtime software)
- Server: PCS 7 OS Software Server
- Client: PCS 7 OS Software Client

You only need the corresponding licenses in order to use the pre-installed SIMATIC PCS 7 software.

Note:

Please note the standard installation when using the SIMATIC Process Control System IPC within the SIMATIC PCS 7 process control system for other tasks, e.g. as basic hardware for SIMATIC BATCH, SIMATIC Route Control, PCS 7 TeleControl, PCS 7 PowerControl, PCS 7 Process Historian, PCS 7 Information Server or PCS 7 Web Server. You can then expand or discard the existing SIMATIC PCS 7 pre-installation, or restore it using one of the Restore DVD sets included (for details, see "Restore DVD set" for the relevant IPC type).

Design

Types of plant bus communication

A Process Control System IPC in the single station or server version can be operated in a variety of ways on the Industrial Ethernet plant bus, depending on the type and number of automation systems connected:

Interface module	Software	for AS communication
Communications module CP 1623/CP 1628	SIMATIC NET HARDNET-IE S7 communication software, licensed for up to four CP 1623/CP 1628 (4x license)	with up to 64 AS single stations (no AS redundancy stations)
	SIMATIC NET HARDNET-IE S7-REDCONNECT communication software, licensed for up to four CP 1623/CP 1628 (4x license)	with redundant automation systems (Redundancy Stations)
Ethernet card	BCE (Basic Communication Ethernet) license	with up to 8 AS single stations

The SIMATIC NET HARDNET-IE S7-REDCONNECT PowerPack is suitable for upgrading the SIMATIC NET HARDNET-IE S7 communication software. For order data, see "Industrial Communication" section, "Industrial Ethernet, System Connection PCS 7 Systems" subsection.

The Industrial Ethernet versions of the SIMATIC Process Control System IPC for single stations and servers are equipped as standard with a CP 1623 communications module and SIMATIC NET HARDNET-IE S7 communication software. The BCE license is relevant for the BCE versions of the SIMATIC Process Control System IPC.

Upgrade from BCE to CP 1623/1628 communication

OS single station and OS server with BCE communication can be retro-upgraded for communication with CP 1623/1628. Items required:

- Network card for connecting to Industrial Ethernet:
 - CP 1623 with PCI Express interface or
 - CP 1628 with PCI Express interface and additional security functions
- S7 Communication Software for CP 1623/CP 1628
 - SIMATIC NET HARDNET-IE S7 for communication with AS single stations or
 - SIMATIC NET HARDNET-IE S7 REDCONNECT for communication with AS redundancy stations and AS single stations

You can find more information about the components and order data in the "Industrial Communication" section, "Industrial Ethernet, System Connection PCS 7 Systems" subsection.

Expansion components

The core component of the SIMATIC Process Control System IPC is a SIMATIC industrial PC without mouse, keyboard or monitor. This basic hardware can be expanded further with the following components from this catalog depending on the environment of use and customer requirements:

- Accessories
 - Memory modules
 - Country-specific power supply cord
 - Tower kit (IPC847E only)
- Expansion components
 - Mouse and keyboard
 - Input tools (touch pens)
 - Smart card reader

Multi-monitor mode can be selected when configuring the SIMATIC Process Control System IPC using the selection table or configurator, but it can also be installed and expanded later. The number of process monitors that can be operated on a SIMATIC Process Control System IPC varies according to the IPC type and configuration. In the maximum configuration, multi-monitor mode with 4 process monitors is possible depending on the IPC type.

Overview



SIMATIC IPC647E

Based on a SIMATIC Rack PC of type IPC647E, SIMATIC Process Control System IPCs in 19" format are extremely compact, rugged and powerful. They are UL-certified and have the CE mark for use in industry as well as residential, business and commercial environments. They are therefore ideally suited for use as a Single Station, Server or Client in the SIMATIC PCS 7 process control system. They enable high packing density in the control cabinet and save a significant amount of space in the control room due to their low overall height (2 HU).

Design

The SIMATIC Process Control System IPCs of type IPC647E have a painted all-metal enclosure in 19" rack design (2 U), which is specially protected against dust by a filter and overpressure ventilation. This mechanically and electromechanically rugged enclosure has a service-friendly design.

SIMATIC Process Control System IPCs of type IPC647E are especially suitable for space-saving mounting in 500-mm deep 19" control cabinets due to their compact dimensions. They can be installed or positioned horizontally.

SIMATIC Process Control System IPCs of type IPC647E are suitable for reliable 24-hour continuous operation at ambient temperatures between 5 and 50 °C. Shocks up to 5 g and vibrations up to 0.5 g can be tolerated during operation.

Restore installations

The operating system and SIMATIC PCS 7 software are pre-installed on the SIMATIC Process Control System IPC. The table below shows the contents of the Restore installations and the pre-installed software for each version of the SIMATIC Process Control System IPC.

SIMATIC Process Control System IPC for PCS 7 V9.1	Restore installations	Pre-installed on delivery
ES/OS single station, OS client		
SIMATIC PCS 7 ES/OS single station, OS client IPC647E (IE or BCE)	Restore Image 1: Operating system Windows 10 IoT Enterprise 2019 LTSC 64-bit with default settings for optimal SIMATIC PCS 7 operation	–
	Restore Image 2:	Can be selected during commissioning
	• Operating system Windows 10 IoT Enterprise 2019 LTSC 64-bit plus software installation for operation as ES/OS single station	–
	• Operating system Windows 10 IoT Enterprise 2019 LTSC 64-bit plus software installation for operation as OS Client	●
Server		
SIMATIC PCS 7 OS Server IPC647E (IE or BCE)	Restore Image 1: Windows Server 2019 Standard Edition 64-bit operating system with default settings for optimal SIMATIC PCS 7 operation	–
	Restore Image 2:	Can be selected during commissioning
	• Operating system Windows Server 2019 Standard Edition 64-bit plus software installation for operation as OS Server	●
	• Operating system Windows Server 2019 Standard Edition 64-bit plus software installation for operation as engineering station	–
	• Operating system Windows Server 2019 Standard Edition 64-bit plus software installation for operation as SIMATIC PCS 7 Web Server	–

Individual configuration of SIMATIC Process Control System IPC

By selecting predefined equipment features, you can individually configure the SIMATIC Process Control System IPC with the desired article numbers. Selection tables for single station, server and client versions are available in the "Ordering data" section (paper catalog). An additional selection table enables you to order complete SIMATIC Process Control System IPCs as a replacement part.

The SIMATIC Process Control System IPC647E configurator in the Industry Mall allows you to interactively select and directly order the SIMATIC Process Control System IPC in the single station, server or client version – either directly for the system or as replacement part.

Individually configurable SIMATIC Process Control System IPCs are only manufactured after the order is received (built to order). Therefore the average delivery time for such an order is 15 working days.

SIMATIC PCS 7 system hardware

Process Control System IPC

SIMATIC Rack PC

IPC647E

Ordering data

Individually configurable SIMATIC Process Control System IPC647E

	Article No.							Article No.													
SIMATIC Process Control System - IPC647E For ES/OS single station, OS client	6ES7661-0							SIMATIC Process Control System - IPC647E For ES/OS single station, OS client							6ES7661-0						
(RACK PC, 19", 2 U) Interfaces: 3 x Gbps Ethernet (IE/PN, RJ45); M.2 PCIe x4 (Key M) slot internal; 1 x DVI-D; 2 x DisplayPort; 1 x COM (RS 232, 9-pin); audio; 4 x USB3.1 Gen2 (Type A), 2 x USB3.1 Gen2 (Type C) on the rear side; 2 x USB3.1 Gen 1 (Type A) on the front; 1 x USB3.1 Gen2 (Type A) internal Temperature and fan monitoring, watchdog, card retainer								(RACK PC, 19", 2 U) Interfaces: 3 x Gbps Ethernet (IE/PN, RJ45); M.2 PCIe x4 (Key M) slot internal; 1 x DVI-D; 2 x DisplayPort; 1 x COM (RS 232, 9-pin); audio; 4 x USB3.1 Gen2 (Type A), 2 x USB3.1 Gen2 (Type C) on the rear side; 2 x USB3.1 Gen 1 (Type A) on the front; 1 x USB3.1 Gen2 (Type A) internal Temperature and fan monitoring, watchdog, card retainer													
Processor and system type								Main memory													
Core i5-8500 (6C/6T, 3.0 (4.1) GHz, 9 MB cache, TB, AMT)								• 8 GB DDR4 SDRAM (2 x 4 GB), dual channel							0						
• Core i5-8500 (6C/6T, 3.0 (4.1) GHz, 9 MB cache, TB, AMT) - PCS 7 ES/OS single station, OS client ¹⁾	A							• 16 GB DDR4 SDRAM (2 x 8 GB), dual channel							1						
Core i7-8700 (6C/12T, 3.2 (4.6) GHz, 12 MB cache, TB, AMT)								• 32 GB DDR4 SDRAM (2 x 16 GB), dual channel							2						
• Core i7-8700 (6C/12T, 3.2 (4.6) GHz, 12 MB cache, TB, AMT) - PCS 7 ES/OS single station, OS client ¹⁾	E							• 64 GB DDR4 SDRAM (4 x 16 GB), dual channel							3						
Xeon E-2176G (6C/12T, 3.7 (4.7) GHz, 12 MB cache, TB, AMT)								• 128 GB DDR4 SDRAM (4 x 32 GB), dual channel							4						
• Xeon E-2176G (6C/12T, 3.7 (4.7) GHz, 12 MB cache, TB, AMT) - PCS 7 ES/OS single station, OS client	J							• 16 GB DDR4 SDRAM (2 x 8 GB), ECC, dual channel, (only with Xeon processor) ¹⁾							5						
Xeon E-2278GE (8C/16T, 3.3 (4.7) GHz, 16 MB cache, TB, AMT)								• 32 GB DDR4 SDRAM (2 x 16 GB), ECC, dual channel, (only with Xeon processor) ¹⁾							6						
• Xeon E-2278GE (8C/16T, 3.3 (4.7) GHz, 16 MB cache, TB, AMT) - PCS 7 ES/OS single station, OS client	N							• 64 GB DDR4 SDRAM (4 x 16 GB), ECC, dual channel, (only with Xeon processor) ¹⁾							7						
Drives:								Software installation													
(HDD)								• PCS 7 V9.1 pre-installed							1						
• 1 TB HDD [Enterprise] 3.5" SATA	A							Operating system / Restore data storage medium / TPM													
• 2 TB HDD [Enterprise] 3.5" SATA	B							• Windows 10 Enterprise 2019 LTSC, MUI (en, de, fr, it, sp, ch), 64-bit, without Restore USB flash drive							A						
• RAID1, 2 x 1 TB HDD [Enterprise] 3.5" SATA	C							• Windows 10 Enterprise 2019 LTSC, MUI (en, de, fr, it, sp, ch), 64-bit, without Restore USB flash drive, TPM 2.0 (not for China)							B						
• RAID1, 2 x 2 TB HDD [Enterprise] 3.5" SATA	D							• Windows 10 Enterprise 2019 LTSC, MUI (en, de, fr, it, sp, ch), 64-bit, with Restore USB flash drive							C						
								• Windows 10 Enterprise 2019 LTSC, MUI (en, de, fr, it, sp, ch), 64-bit, with Restore USB flash drive, TPM 2.0 (not for China)							D						
SSD								Bus module / Communication / Multi-monitor													
• 480 GB SSD 2.5" SATA	P							• Bus module 4-slot: 2 x PCI, 2 x PCIe x16 (8 L)							A						
• 960 GB SSD 2.5" SATA	Q							• Bus module 4-slot: 2 x PCI, 2 x PCIe x16 (8 L), multi-monitor 4-5 displays, combined, onboard interfaces (2 x DP) + PCIe x16 graphics card (3 x mDP: 3 x adapter mDP on DP), 2 GB (1 slot occupied)							B						
• 1920 GB SSD 2.5" SATA	R							• Bus module 4-slot: 2 x PCI, 2 x PCIe x16 (8 L), BCE							C						
• RAID1, 2 x 480 GB SSD 2.5" SATA	S							• Bus module 4-slot: 2 x PCI, 2 x PCIe x16 (8 L), BCE, multi-monitor 4-5 displays, combined, onboard interfaces (2 x DP) + PCIe x16 graphics card (3 x mDP: 3 x adapter mDP on DP), 2 GB (1 slot occupied)							D						
• RAID1, 2 x 960 GB SSD 2.5" SATA	T							• Bus module 4-slot: 2 x PCI, 2 x PCIe x16 (8 L), Industrial Ethernet (CP1623), (1 slot occupied)							E						
• RAID1, 2 x 1920 GB SSD 2.5" SATA	U							• Bus module 4-slot: 2 x PCI, 2 x PCIe x16 (8 L), Industrial Ethernet (CP1623), (1 slot occupied), multi-monitor 4-5 displays, combined, onboard interfaces (2 x DP) + PCIe x16 graphics card (3 x mDP: 3 x adapter mDP on DP), 2 GB (1 slot occupied)							F						
Without drives ²⁾	X							• Bus module 4-slot: 2 x PCI, 2 x PCIe x16 (8 L), 1 x PCIe x16 (4 L), 1 x PCIe x16 (1 L)							G						
Drive cage / M.2 memory																					
• Drive cage for internal installation, 0.5 g vibration, 5 g shock ²⁾	0																				
• Drive cage for internal installation, 0.5 g vibration, 5 g shock, 512 GB SSD M.2 NVMe (M.2 slot occupied) (for operating system)	1																				
• Drive cage for internal installation, 0.5 g vibration, 5 g shock, 1024 GB SSD M.2 NVMe (M.2 slot occupied) (for operating system)	2																				
• Drive cage for removable trays, on the front ²⁾	4																				
• Drive cage for removable trays, on the front, 512 GB SSD M.2 NVMe (M.2 slot occupied) (for operating system)	5																				
• Drive cage for removable trays, on the front, 1024 GB SSD M.2 NVMe (M.2 slot occupied) (for operating system)	6																				

Ordering data (continued)

	Article No.		Article No.
SIMATIC Process Control System - IPC647E For ES/OS single station, OS client	6ES7661-		SIMATIC Process Control System - IPC647E For OS Server, Engineering Server, Web Server
(RACK PC, 19", 2 U) Interfaces: 3 x Gbps Ethernet (IE/PN, RJ45); M.2 PCIe x4 (Key M) slot internal; 1 x DVI-D; 2 x DisplayPort; 1 x COM (RS 232, 9-pin); audio; 4 x USB3.1 Gen2 (Type A), 2 x USB3.1 Gen2 (Type C) on the rear side; 2 x USB3.1 Gen 1 (Type A) on the front; 1 x USB3.1 Gen2 (Type A) internal Temperature and fan monitoring, watchdog, card retainer	0		(RACK PC, 19", 2 U) Interfaces: 3 x Gbps Ethernet (IE/PN, RJ45); M.2 PCIe x4 (Key M) slot internal; 1 x DVI-D; 2 x DisplayPort; 1 x COM (RS 232, 9-pin); audio; 4 x USB3.1 Gen2 (Type A), 2 x USB3.1 Gen2 (Type C) on the rear side; 2 x USB3.1 Gen 1 (Type A) on the front; 1 x USB3.1 Gen2 (Type A) internal Temperature and fan monitoring, watchdog, card retainer
<ul style="list-style-type: none"> • Bus module 4-slot: 2 x PCIe x16 (8 L), 1 x PCIe x16 (4 L), 1 x PCIe x16 (1 L), multi-monitor 4–5 screens, combined, onboard interfaces (2 x DP) + PCIe x16 graphics card (3 x mDP: 3 x adapter mDP on DP), 2 GB (1 slot occupied) • Bus module 4-slot: 2 x PCIe x16 (8 L), 1 x PCIe x16 (4 L), 1 x PCIe x16 (1 L), BCE • Bus module 4-slot: 2 x PCIe x16 (8 L), 1 x PCIe x16 (4 L), 1 x PCIe x16 (1 L), BCE, multi-monitor 4–5 screens, combined, onboard interfaces (2 x DP) + PCIe x16 graphics card (3 x mDP: 3 x adapter mDP on DP), 2 GB (1 slot occupied) • Bus module 4-slot: 2 x PCIe x16 (8 L), 1 x PCIe x16 (4 L), 1 x PCIe x16 (1 L), Industrial Ethernet (CP1623), (1 slot occupied) • Bus module 4-slot: 2 x PCIe x16 (8 L), 1 x PCIe x16 (4 L), 1 x PCIe x16 (1 L), Industrial Ethernet (CP1623), (1 slot occupied), multi-monitor 4–5 screens, combined, onboard interfaces (2 x DP) + PCIe x16 graphics card (3 x mDP: 3 x adapter mDP on DP), 2 GB (1 slot occupied) 		H	<p>Processor and system type</p> <p><u>Core i5-8500 (6C/6T, 3.0 (4.1) GHz, 9 MB cache, TB, AMT)</u></p> <ul style="list-style-type: none"> • Core i5-8500 (6C/6T, 3.0 (4.1) GHz, 9 MB cache, TB, AMT) - PCS 7 OS Server, Engineering Server, Web Server¹⁾ <p><u>Core i7-8700 (6C/12T, 3.2 (4.6) GHz, 12 MB cache, TB, AMT)</u></p> <ul style="list-style-type: none"> • Core i7-8700 (6C/12T, 3.2 (4.6) GHz, 12 MB cache, TB, AMT) - PCS 7 OS Server, Engineering Server, Web Server¹⁾ <p><u>Xeon E-2176G (6C/12T, 3.7 (4.7) GHz, 12 MB cache, TB, AMT)</u></p> <ul style="list-style-type: none"> • Xeon E-2176G (6C/12T, 3.7 (4.7) GHz, 12 MB cache, TB, AMT) - PCS 7 OS Server, Engineering Server, Web Server <p><u>Xeon E-2278GE (8C/16T, 3.3 (4.7) GHz, 16 MB cache, TB, AMT)</u></p> <ul style="list-style-type: none"> • Xeon E-2278GE (8C/16T, 3.3 (4.7) GHz, 16 MB cache, TB, AMT) - PCS 7 OS Server, Engineering Server, Web Server
Power supply / power supply cord			Drives:
<ul style="list-style-type: none"> • 100/240 V AC industrial power supply - Without power supply cord - Power supply cord for Europe - Power supply cord for USA - Power supply cord for China • 2 x 100/240 V AC redundant industrial power supply unit - Without power supply cord - Power supply cord for Europe - Power supply cord for USA - Power supply cord for China 	0 1 2 3 4 5 6 7		<p>(HDD)</p> <ul style="list-style-type: none"> • 1 TB HDD [Enterprise] 3.5" SATA • 2 TB HDD [Enterprise] 3.5" SATA • RAID1, 2 x 1 TB HDD [Enterprise] 3.5" SATA • RAID1, 2 x 2 TB HDD [Enterprise] 3.5" SATA <p><u>HW RAID, SAS</u></p> <ul style="list-style-type: none"> • RAID1, 2 x 2 TB HDD [Enterprise] 3.5" SAS; PCIe x8 RAID controller incl. ZMCP module (1 slot occupied)²⁾ <p><u>SSD</u></p> <ul style="list-style-type: none"> • 480 GB SSD 2.5" SATA • 960 GB SSD 2.5" SATA • 1920 GB SSD 2.5" SATA • RAID1, 2 x 480 GB SSD 2.5" SATA • RAID1, 2 x 960 GB SSD 2.5" SATA • RAID1, 2 x 1920 GB SSD 2.5" SATA <p>Without drives³⁾</p>
			A B C D G P Q R S T U X
			Drive cage / M.2 memory
			<ul style="list-style-type: none"> • Drive cage for internal installation, 0.5 g vibration, 5 g shock²⁾³⁾ • Drive cage for internal installation, 0.5 g vibration, 5 g shock, 512 GB SSD M.2 NVMe (M.2 slot occupied) (for operating system)²⁾ • Drive cage for internal installation, 0.5 g vibration, 5 g shock, 1024 GB SSD M.2 NVMe (M.2 slot occupied) (for operating system)²⁾ • Drive cage for removable trays, on the front³⁾ • Drive cage for removable trays, on the front, 512 GB SSD M.2 NVMe (M.2 slot occupied) (for operating system) • Drive cage for removable trays, on the front, 1024 GB SSD M.2 NVMe (M.2 slot occupied) (for operating system)
			0 1 2 4 5 6

1) Selection criterion "Processor / System type", Position A, E, cannot be combined with selection criterion "Main memory", Position 5, 6, 7

2) Selection criterion "Drives", Position X, cannot be combined with selection criterion "Drive cage / M.2 memory", Position 0, 4

SIMATIC PCS 7 system hardware

Process Control System IPC

SIMATIC Rack PC

IPC647E

Ordering data (continued)

	Article No.									
SIMATIC Process Control System - IPC647E For OS Server, Engineering Server, Web Server	6ES7661-									
(RACK PC, 19", 2 U) Interfaces: 3 x Gbps Ethernet (IE/PN, RJ45); M.2 PCIe x4 (Key M) slot internal; 1 x DVI-D; 2 x DisplayPort; 1 x COM (RS 232, 9-pin); audio; 4 x USB3.1 Gen2 (Type A), 2 x USB3.1 Gen2 (Type C) on the rear side; 2 x USB3.1 Gen 1 (Type A) on the front; 1 x USB3.1 Gen2 (Type A) internal Temperature and fan monitoring, watchdog, card retainer	0									
Main memory										
• 8 GB DDR4 SDRAM (2 x 4 GB), dual channel					0					
• 16 GB DDR4 SDRAM (2 x 8 GB), dual channel					1					
• 32 GB DDR4 SDRAM (2 x 16 GB), dual channel					2					
• 64 GB DDR4 SDRAM (4 x 16 GB), dual channel					3					
• 128 GB DDR4 SDRAM (4 x 32 GB), dual channel					4					
• 16 GB DDR4 SDRAM (2 x 8 GB), ECC, dual channel, (only with Xeon processor ¹⁾)					5					
• 32 GB DDR4 SDRAM (2 x 16 GB), ECC, dual channel, (only with Xeon processor ¹⁾)					6					
• 64 GB DDR4 SDRAM (4 x 16 GB), ECC, dual channel, (only with Xeon processor ¹⁾)					7					
Software installation										
• PCS 7 V9.1 pre-installed						1				
Operating system / Restore data storage medium / TPM										
• Windows Server 2019 Standard Edition incl. 16-core, 5 clients, 64-bit, MUI (en, de, fr, it, sp, ch), without Restore USB flash drive							P			
• Windows Server 2019 Standard Edition incl. 16-core, 5 clients, 64-bit, MUI (en, de, fr, it, sp, ch), without Restore USB flash drive, TPM 2.0 (not for China)							Q			
• Windows Server 2019 Standard Edition incl. 16-core, 5 clients, 64-bit, MUI (en, de, fr, it, sp, ch), with Restore USB flash drive							R			
• Windows Server 2019 Standard Edition incl. 16-core, 5 clients, 64-bit, MUI (en, de, fr, it, sp, ch), with Restore USB flash drive, TPM 2.0 (not for China)							S			
Bus module / Communication / Multi-monitor										
• Bus module 4-slot: 2 x PCI, 2 x PCIe x16 (8 L)								A		
• Bus module 4-slot: 2 x PCI, 2 x PCIe x16 (8 L), multi-monitor 4-5 displays, combined, onboard interfaces (2 x DP) + PCIe x16 graphics card (3 x mDP: 3 x adapter mDP on DP), 2 GB (1 slot occupied)								B		
• Bus module 4-slot: 2 x PCI, 2 x PCIe x16 (8 L), BCE								C		
• Bus module 4-slot: 2 x PCI, 2 x PCIe x16 (8 L), BCE, multi-monitor 4-5 displays, combined, onboard interfaces (2 x DP) + PCIe x16 graphics card (3 x mDP: 3 x adapter mDP on DP), 2 GB (1 slot occupied)								D		
• Bus module 4-slot: 2 x PCI, 2 x PCIe x16 (8 L), Industrial Ethernet (CP1623), (1 slot occupied)								E		
• Bus module 4-slot: 2 x PCI, 2 x PCIe x16 (8 L), Industrial Ethernet (CP1623), (1 slot occupied), multi-monitor 4-5 displays, combined, onboard interfaces (2 x DP) + PCIe x16 graphics card (3 x mDP: 3 x adapter mDP on DP), 2 GB (1 slot occupied) ²⁾								F		
• Bus module 4-slot: 2 x PCIe x16 (8 L), 1 x PCIe x16 (4 L), 1 x PCIe x16 (1 L)									G	
SIMATIC Process Control System - IPC647E For OS Server, Engineering Server, Web Server	6ES7661-									
(RACK PC, 19", 2 U) Interfaces: 3 x Gbps Ethernet (IE/PN, RJ45); M.2 PCIe x4 (Key M) slot internal; 1 x DVI-D; 2 x DisplayPort; 1 x COM (RS 232, 9-pin); audio; 4 x USB3.1 Gen2 (Type A), 2 x USB3.1 Gen2 (Type C) on the rear side; 2 x USB3.1 Gen 1 (Type A) on the front; 1 x USB3.1 Gen2 (Type A) internal Temperature and fan monitoring, watchdog, card retainer	0									
• Bus module 4-slot: 2 x PCIe x16 (8 L), 1 x PCIe x16 (4 L), 1 x PCIe x16 (1 L), multi-monitor 4-5 screens, combined, onboard interfaces (2 x DP) + PCIe x16 graphics card (3 x mDP: 3 x adapter mDP on DP), 2 GB (1 slot occupied)										H
• Bus module 4-slot: 2 x PCIe x16 (8 L), 1 x PCIe x16 (4 L), 1 x PCIe x16 (1 L), BCE										J
• Bus module 4-slot: 2 x PCIe x16 (8 L), 1 x PCIe x16 (4 L), 1 x PCIe x16 (1 L), BCE, multi-monitor 4-5 screens, combined, onboard interfaces (2 x DP) + PCIe x16 graphics card (3 x mDP: 3 x adapter mDP on DP), 2 GB (1 slot occupied)										K
• Bus module 4-slot: 2 x PCIe x16 (8 L), 1 x PCIe x16 (4 L), 1 x PCIe x16 (1 L), Industrial Ethernet (CP1623), (1 slot occupied)										L
• Bus module 4-slot: 2 x PCIe x16 (8 L), 1 x PCIe x16 (4 L), 1 x PCIe x16 (1 L), multi-monitor 4-5 screens, combined, onboard interfaces (2 x DP) + PCIe x16 graphics card (3 x mDP: 3 x adapter mDP on DP), 2 GB (1 slot occupied)										M
Power supply / power supply cord										
• 100/240 V AC industrial power supply										
- Without power supply cord										0
- Power supply cord for Europe										1
- Power supply cord for USA										2
- Power supply cord for China										3
• 2 x 100/240 V AC redundant industrial power supply unit										
- Without power supply cord										4
- Power supply cord for Europe										5
- Power supply cord for USA										6
- Power supply cord for China										7

¹⁾ Selection criterion "Processor / System type", Position B, F, cannot be combined with selection criterion "Main memory", Position 5, 6, 7

²⁾ Selection criterion "Drives", Position G, cannot be combined with selection criterion "Drive cage / M.2 memory", Position 0, 1, 2, or with selection criterion "Bus module / Communication / Multi-monitor", Position F

³⁾ Selection criterion "Drives", Position X, cannot be combined with selection criterion "Drive cage / M.2 memory", Position 0, 4

Ordering data (continued)

SIMATIC Process Control System IPC647E as spare part

	Article No.									
SIMATIC Process Control System - IPC647E Spare part	6ES7661-									
(RACK PC, 19", 2 U) Interfaces: 3 x Gbps Ethernet (IE/PN, RJ45); M.2 PCIe x4 (Key M) slot internal; 1 x DVI-D; 2 x DisplayPort; 1 x COM (RS 232, 9-pin); audio; 4 x USB3.1 Gen2 (Type A), 2 x USB3.1 Gen2 (Type C) on the rear side; 2 x USB3.1 Gen 1 (Type A) on the front; 1 x USB3.1 Gen2 (Type A) internal Temperature and fan monitoring, watchdog, card retainer	0									
Processor and system type										
<u>Core i5-8500 (6C/6T, 3.0 (4.1) GHz, 9 MB cache, TB, AMT)</u> • Core i5-8500 (6C/6T, 3.0 (4.1) GHz, 9 MB cache, TB, AMT) - spare part ¹⁾	V									
<u>Core i7-8700 (6C/12T, 3.2 (4.6) GHz, 12 MB cache, TB, AMT)</u> • Core i7-8700 (6C/12T, 3.2 (4.6) GHz, 12 MB cache, TB, AMT) - spare part ¹⁾	W									
<u>Xeon E-2176G (6C/12T, 3.7 (4.7) GHz, 12 MB cache, TB, AMT)</u> • Xeon E-2176G (6C/12T, 3.7 (4.7) GHz, 12 MB cache, TB, AMT) - Spare part	X									
<u>Xeon E-2278GE (8C/16T, 3.3 (4.7) GHz, 16 MB cache, TB, AMT)</u> • Xeon E-2278GE (8C/16T, 3.3 (4.7) GHz, 16 MB cache, TB, AMT) - Spare part	Y									
Drives:										
<u>(HDD)</u>										
• 1 TB HDD [Enterprise] 3.5" SATA	A									
• 2 TB HDD [Enterprise] 3.5" SATA	B									
• RAID1, 2 x 1 TB HDD [Enterprise] 3.5" SATA	C									
• RAID1, 2 x 2 TB HDD [Enterprise] 3.5" SATA	D									
<u>HW RAID, SAS</u>										
• RAID1, 2 x 2 TB HDD [Enterprise] 3.5" SAS; PCIe x8 RAID controller incl. ZMCP module (1 slot occupied) ²⁾	G									
<u>SSD</u>										
• 480 GB SSD 2.5" SATA	P									
• 960 GB SSD 2.5" SATA	Q									
• 1920 GB SSD 2.5" SATA	R									
• RAID1, 2 x 480 GB SSD 2.5" SATA	S									
• RAID1, 2 x 960 GB SSD 2.5" SATA	T									
• RAID1, 2 x 1920 GB SSD 2.5" SATA	U									
<u>Without drives³⁾</u>	X									
Drive cage / M.2 memory										
• Drive cage for internal installation, 0.5 g vibration, 5 g shock ²⁾³⁾	0									
• Drive cage for internal installation, 0.5 g vibration, 5 g shock, 512 GB SSD M.2 NVMe (M.2 slot occupied) (for operating system) ²⁾	1									
• Drive cage for internal installation, 0.5 g vibration, 5 g shock, 1024 GB SSD M.2 NVMe (M.2 slot occupied) (for operating system) ²⁾	2									
• Drive cage for removable trays, on the front ³⁾	4									
• Drive cage for removable trays, on the front, 512 GB SSD M.2 NVMe (M.2 slot occupied) (for operating system)	5									
• Drive cage for removable trays, on the front, 1024 GB SSD M.2 NVMe (M.2 slot occupied) (for operating system)	6									
SIMATIC Process Control System - IPC647E Spare part	6ES7661-									
(RACK PC, 19", 2 U) Interfaces: 3 x Gbps Ethernet (IE/PN, RJ45); M.2 PCIe x4 (Key M) slot internal; 1 x DVI-D; 2 x DisplayPort; 1 x COM (RS 232, 9-pin); audio; 4 x USB3.1 Gen2 (Type A), 2 x USB3.1 Gen2 (Type C) on the rear side; 2 x USB3.1 Gen 1 (Type A) on the front; 1 x USB3.1 Gen2 (Type A) internal Temperature and fan monitoring, watchdog, card retainer	0									
Main memory										
• 8 GB DDR4 SDRAM (2 x 4 GB), dual channel	0									
• 16 GB DDR4 SDRAM (2 x 8 GB), dual channel	1									
• 32 GB DDR4 SDRAM (2 x 16 GB), dual channel	2									
• 64 GB DDR4 SDRAM (4 x 16 GB), dual channel	3									
• 128 GB DDR4 SDRAM (4 x 32 GB), dual channel	4									
• 16 GB DDR4 SDRAM (2 x 8 GB), ECC, dual channel, (only with Xeon processor) ¹⁾	5									
• 32 GB DDR4 SDRAM (2 x 16 GB), ECC, dual channel, (only with Xeon processor) ¹⁾	6									
• 64 GB DDR4 SDRAM (4 x 16 GB), ECC, dual channel, (only with Xeon processor) ¹⁾	7									
Software installation										
• Without pre-installation									8	
Operating system / Restore data storage medium / TPM										
• Windows 10 Enterprise 2019 LTSC, MUI (en, de, fr, it, sp, ch), 64-bit, without Restore USB flash drive ²⁾										A
• Windows 10 Enterprise 2019 LTSC, MUI (en, de, fr, it, sp, ch), 64-bit, without Restore USB flash drive, TPM 2.0 (not for China) ²⁾										B
• Windows 10 Enterprise 2019 LTSC, MUI (en, de, fr, it, sp, ch), 64-bit, with Restore USB flash drive ²⁾										C
• Windows 10 Enterprise 2019 LTSC, MUI (en, de, fr, it, sp, ch), 64-bit, with Restore USB flash drive, TPM 2.0 (not for China) ²⁾										D
• Windows Server 2019 Standard Edition incl. 16-core, 5 clients, 64-bit, MUI (en, de, fr, it, sp, ch), without Restore USB flash drive										P
• Windows Server 2019 Standard Edition incl. 16-core, 5 clients, 64-bit, MUI (en, de, fr, it, sp, ch), without Restore USB flash drive, TPM 2.0 (not for China)										Q
• Windows Server 2019 Standard Edition incl. 16-core, 5 clients, 64-bit, MUI (en, de, fr, it, sp, ch), with Restore USB flash drive										R
• Windows Server 2019 Standard Edition incl. 16-core, 5 clients, 64-bit, MUI (en, de, fr, it, sp, ch), with Restore USB flash drive, TPM 2.0 (not for China)										S
• Without operating system, without Restore USB flash drive										X
Bus module / Communication / Multi-monitor										
• Bus module 4-slot: 2 x PCI, 2 x PCIe x16 (8 L)										A
• Bus module 4-slot: 2 x PCI, 2 x PCIe x16 (8 L), multi-monitor 4-5 displays, combined, onboard interfaces (2 x DP) + PCIe x16 graphics card (3 x mDP: 3 x adapter mDP on DP), 2 GB (1 slot occupied)										B
• Bus module 4-slot: 2 x PCI, 2 x PCIe x16 (8 L), BCE										C
• Bus module 4-slot: 2 x PCI, 2 x PCIe x16 (8 L), BCE, multi-monitor 4-5 displays, combined, onboard interfaces (2 x DP) + PCIe x16 graphics card (3 x mDP: 3 x adapter mDP on DP), 2 GB (1 slot occupied)										D

SIMATIC PCS 7 system hardware

Process Control System IPC

SIMATIC Rack PC

IPC647E

Accessories (continued)

	Article No.
SIMATIC Process Control System - IPC647E Spare part	6ES7661-
(RACK PC, 19", 2 U) Interfaces: 3 x Gbps Ethernet (IE/PN, RJ45); M.2 PCIe x4 (Key M) slot internal; 1 x DVI-D; 2 x DisplayPort; 1 x COM (RS 232, 9-pin); audio; 4 x USB3.1 Gen2 (Type A), 2 x USB3.1 Gen2 (Type C) on the rear side; 2 x USB3.1 Gen 1 (Type A) on the front; 1 x USB3.1 Gen2 (Type A) internal Temperature and fan monitoring, watchdog, card retainer	0
• Bus module 4-slot: 2 x PCI, 2 x PCIe x16 (8 L), Industrial Ethernet (CP1623), (1 slot occupied)	E
• Bus module 4-slot: 2 x PCI, 2 x PCIe x16 (8 L), Industrial Ethernet (CP1623), (1 slot occupied), multi-monitor 4-5 displays, combined, onboard interfaces (2 x DP) + PCI x16 graphics card (3 x mDP: 3 x adapter mDP on DP), 2 GB (1 slot occupied) ²⁾	F
• Bus module 4-slot: 2 x PCIe x16 (8 L), 1 x PCIe x16 (4 L), 1 x PCIe x16 (1 L)	G
• Bus module 4-slot: 2 x PCIe x16 (8 L), 1 x PCIe x16 (4 L), 1 x PCIe x16 (1 L), multi-monitor 4-5 screens, combined, onboard interfaces (2 x DP) + PCIe x16 graphics card (3 x mDP: 3 x adapter mDP on DP), 2 GB (1 slot occupied)	H
• Bus module 4-slot: 2 x PCIe x16 (8 L), 1 x PCIe x16 (4 L), 1 x PCIe x16 (1 L), BCE	J
• Bus module 4-slot: 2 x PCIe x16 (8 L), 1 x PCIe x16 (4 L), 1 x PCIe x16 (1 L), BCE, multi-monitor 4-5 screens, combined, onboard interfaces (2 x DP) + PCIe x16 graphics card (3 x mDP: 3 x adapter mDP on DP), 2 GB (1 slot occupied)	K
• Bus module 4-slot: 2 x PCIe x16 (8 L), 1 x PCIe x16 (4 L), 1 x PCIe x16 (1 L), Industrial Ethernet (CP1623), (1 slot occupied)	L
• Bus module 4-slot: 2 x PCIe x16 (8 L), 1 x PCIe x16 (4 L), 1 x PCIe x16 (1 L), Industrial Ethernet (CP1623), (1 slot occupied), multi-monitor 4-5 screens, combined, onboard interfaces (2 x DP) + PCIe x16 graphics card (3 x mDP: 3 x adapter mDP on DP), 2 GB (1 slot occupied)	M
Power supply / power supply cord	
• 100/240 V AC industrial power supply	0
- Without power supply cord	1
- Power supply cord for Europe	2
- Power supply cord for USA	3
- Power supply cord for China	
• 2 x 100/240 V AC redundant industrial power supply unit	4
- Without power supply cord	5
- Power supply cord for Europe	6
- Power supply cord for USA	7
- Power supply cord for China	

1) Selection criterion "Processor / System type", Position V, W, cannot be combined with selection criterion "Main memory", Position 5, 6, 7
 2) Selection criterion "Drives", Position G, cannot be combined with selection criterion "Drive cage / M.2 memory", Position 0, 1, 2, with selection criterion "Operating system / Restore data storage medium / TPM", Position A, B, C, D, or with selection criterion "Bus module / Communication / Multi-monitor", Position F
 3) Selection criterion "Drives", Position X, cannot be combined with selection criterion "Drive cage / M.2 memory", Position 0, 4

Additional and expansion components

USB keyboard TKL-105 Color: black • Keyboard layout, German • Keyboard layout, US International	6AV6881-0AU14-0AA0 6AV6881-0AU14-1AA0
SIMATIC HMI USB mouse Optical mouse with scroll wheel and USB connection, color anthracite	6AV2181-8AT00-0AX0
Memory expansion • 4 GB DDR4 SDRAM (1 x 4 GB) • 8 GB DDR4 SDRAM (1 x 8 GB) • 16 GB DDR4 SDRAM (1 x 16 GB) • 32 GB DDR4 SDRAM (1 x 32 GB)	6ES7648-2AL60-0QA0 6ES7648-2AL70-0QA0 6ES7648-2AL80-0QA0 6ES7648-2AL81-0QA0
Retainer For locking the internal USB port	6ES7648-1AA00-0XK0
Tray for low-profile removable drive bay For 3.5" hard disk (SATA/SAS) or 2.5" SSD (SATA), without drive	6ES7648-0EH00-1BA0
Adapter cable • DisplayPort to DVI-D for onboard graphics • DisplayPort to VGA for onboard graphics • Mini-DisplayPort to VGA for graphics card • Mini-DisplayPort to DVI-D for graphics card • Mini-DisplayPort to DVI-D for graphics card (3 units per pack) • Mini-DisplayPort to DisplayPort for graphics card • Mini-DisplayPort to DisplayPort for graphics card (3 units per pack)	6ES7648-3AF00-0XA0 6ES7648-3AG00-0XA0 6ES7648-3AL00-0XA0 6ES7648-3AK00-0XA0 6ES7648-3AK00-1XA0 6ES7648-3AJ00-0XA0 6ES7648-3AJ00-1XA0
Power supply cord, 3 m, for Rack PCs • Europe (for Austria, Belgium, Finland, France, Germany, the Netherlands, Spain, Sweden) • For the UK • For Switzerland • For the USA • For Italy • For China	6ES7900-0AA00-0XA0 6ES7900-0BA00-0XA0 6ES7900-0CA00-0XA0 6ES7900-0DA00-0XA0 6ES7900-0EA00-0XA0 6ES7900-0FA00-0XA0
SIMATIC NET HARDNET IE S7 REDCONNECT PowerPack For communication with high-availability AS, see the "Communication" chapter, "Industrial Ethernet – System connection PCS 7 systems" section.	

Accessories

Power supply cord for Rack PC

The SIMATIC PCS 7 preferred types are always delivered with a "European power supply cord". This can be used in Germany, France, Spain, Netherlands, Belgium, Sweden, Austria and Finland. The country-specific versions listed in the Ordering data are required for other countries. The following picture shows the design of a number of power supply plugs:



Overview



SIMATIC IPC847E

The SIMATIC Process Control System IPC type IPC847E is the most powerful and well equipped system platform. It satisfies all requirements for implementing complex server applications and for archiving process data.

Many basic components, such as chip set, processor, work memory, etc. are largely identical to those of type IPC647E. As a result of the double overall height, the SIMATIC Process Control System IPC of type IPC847E has more slots and therefore ample potential for expansions. Since it would be over-dimensioned as a client, it is only offered as a single station and server.

Design

SIMATIC Process Control System IPCs type IPC847E are UL-certified and have the CE marking for use in industry as well as residential, business and commercial environments.

The painted all-metal enclosure in 19" mounting format (4 HUs) is especially protected against dust by a filter and pressurized ventilation. It features a mechanically and electromagnetically rugged design and is very easy to service.

The SIMATIC Process Control System IPC of type IPC847E can be positioned and installed horizontally or vertically. Using an optional tower kit, the Rack PC can be converted into an industry tower. The dimensions of the IPC847E also allow space-saving assembly in 500-mm deep 19" control cabinets.

SIMATIC Process Control System IPCs type IPC847E are suitable for reliable 24-hour continuous operation at ambient temperatures between 5 and 50 °C. Shocks up to 5 g and vibrations up to 0.5 g can be tolerated during operation.

Restore installations

The operating system and SIMATIC PCS 7 software are pre-installed on the SIMATIC Process Control System IPC. The table below shows the contents of the Restore installations and the pre-installed software for each version of the SIMATIC Process Control System IPC.

SIMATIC Process Control System IPC for PCS 7 V9.1	Restore installations	Pre-installed on delivery
ES/OS single station, OS client		
SIMATIC PCS 7 ES/OS single station OS client IPC847E (IE or BCE)	Restore Image 1: Operating system Windows 10 IoT Enterprise 2019 LTSC 64-bit with default settings for optimal SIMATIC PCS 7 operation	–
	Restore Image 2:	Can be selected during commissioning
	• Operating system Windows 10 IoT Enterprise 2019 LTSC 64-bit plus software installation for operation as ES/OS single station	–
	• Operating system Windows 10 IoT Enterprise 2019 LTSC 64-bit plus software installation for operation as OS Client	●
Server		
SIMATIC PCS 7 OS Server IPC847E (IE or BCE)	Restore Image 1: Windows Server 2019 Standard Edition 64-bit operating system with default settings for optimal SIMATIC PCS 7 operation	–
	Restore Image 2:	Can be selected during commissioning
	• Operating system Windows Server 2019 Standard Edition 64-bit plus software installation for operation as OS Server	●
	• Operating system Windows Server 2019 Standard Edition 64-bit plus software installation for operation as engineering station	–
	• Operating system Windows Server 2019 Standard Edition 64-bit plus software installation for operation as SIMATIC PCS 7 Web Server	–

Individual configuration of SIMATIC Process Control System IPC

By selecting predefined equipment features, you can individually configure the SIMATIC Process Control System IPC with the desired article numbers. Selection tables for single station, server and client are available for this in the "Ordering data" (paper catalog) section. An additional selection table enables you to order complete SIMATIC Process Control System IPCs as a replacement part.

The SIMATIC Process Control System IPC847E configurator in the Industry Mall allows you to interactively select and directly order the SIMATIC Process Control System IPC in the single station or server version – either directly for the system or as replacement part.

Individually configurable SIMATIC Process Control System IPCs are only manufactured after the order is received (built to order). Therefore the average delivery time for such an order is 15 working days.

SIMATIC PCS 7 system hardware

Process Control System IPC

SIMATIC Rack PC

IPC847E

Ordering data**Individually configurable SIMATIC Process Control System IPC847E**

	Article No.		Article No.
SIMATIC Process Control System - IPC847E For ES/OS single station, OS client	6ES7661-		SIMATIC Process Control System - IPC847E For ES/OS single station, OS client
(RACK PC, 19", 4 U) Interfaces: 3 x Gbps Ethernet (IE/PN, RJ45); 1 x DVI-D; 2 x DisplayPort; 1 x COM (RS 232, 9-pin); audio; 4 x USB3.1 Gen2 (Type A), 2 x USB3.1 Gen2 (Type C) on the rear side; 2 x USB3.1 Gen 1 (Type A) on the front; 1 x USB3.1 Gen2 (Type A) internal Temperature and fan monitoring, watchdog, card retainer	1		(RACK PC, 19", 4 U) Interfaces: 3 x Gbps Ethernet (IE/PN, RJ45); 1 x DVI-D; 2 x DisplayPort; 1 x COM (RS 232, 9-pin); audio; 4 x USB3.1 Gen2 (Type A), 2 x USB3.1 Gen2 (Type C) on the rear side; 2 x USB3.1 Gen 1 (Type A) on the front; 1 x USB3.1 Gen2 (Type A) internal Temperature and fan monitoring, watchdog, card retainer
Processor and system type			Drive cage / M.2 memory
Core i5-8500 (6C/6T, 3.0 (4.1) GHz, 9 MB cache, TB, AMT)	A		• Drive cage for internal installation, 0.5 g vibration, 5 g shock ²⁾³⁾
• Core i5-8500 (6C/6T, 3.0 (4.1) GHz, 9 MB cache, TB, AMT) - PCS 7 ES/OS single station, OS client ¹⁾			• Drive cage for internal installation, 0.5 g vibration, 5 g shock, 512 GB SSD M.2 NVMe on PCIe x4 adapter card (1 slot occupied) (for operating system) ²⁾
Core i7-8700 (6C/12T, 3.2 (4.6) GHz, 12 MB cache, TB, AMT)	E		• Drive cage for internal installation, 0.5 g vibration, 5 g shock, 1024 GB SSD M.2 NVMe on PCIe x4 adapter card (1 slot occupied) (for operating system) ²⁾
• Core i7-8700 (6C/12T, 3.2 (4.6) GHz, 12 MB cache, TB, AMT) - PCS 7 ES/OS single station, OS client ¹⁾			• Drive cage for removable trays, on the front ³⁾
Xeon E-2176G (6C/12T, 3.7 (4.7) GHz, 12 MB cache, TB, AMT)	J		• Drive cage for removable trays, on the front, 512 GB SSD M.2 NVMe on PCIe x4 adapter card (1 slot occupied) (for operating system)
• Xeon E-2176G (6C/12T, 3.7 (4.7) GHz, 12 MB cache, TB, AMT) - PCS 7 ES/OS single station, OS client			• Drive cage for removable trays, on the front, 1024 GB SSD M.2 NVMe on PCIe x4 adapter card (1 slot occupied) (for operating system)
Xeon E-2278GE (8C/16T, 3.3 (4.7) GHz, 16 MB cache, TB, AMT)	N		
• Xeon E-2278GE (8C/16T, 3.3 (4.7) GHz, 16 MB cache, TB, AMT) - PCS 7 ES/OS single station, OS client			Main memory
Drives:			• 8 GB DDR4 SDRAM (2 × 4 GB), dual channel
(HDD)			• 16 GB DDR4 SDRAM (2 × 8 GB), dual channel
• 1 TB HDD [Enterprise] 3.5" SATA	A		• 32 GB DDR4 SDRAM (2 × 16 GB), dual channel
• 2 TB HDD [Enterprise] 3.5" SATA	B		• 64 GB DDR4 SDRAM (4 × 16 GB), dual channel
• RAID1, 2 x 1 TB HDD [Enterprise] 3.5" SATA	C		• 128 GB DDR4 SDRAM (4 × 32 GB), dual channel
• RAID1, 2 x 2 TB HDD [Enterprise] 3.5" SATA	D		• 16 GB DDR4 SDRAM (2 × 8 GB), ECC, dual channel, (only with Xeon processor) ¹⁾
• RAID1, 2 x 2 TB HDD [Enterprise] 3.5" SATA + 2 TB HDD [Enterprise] 3.5" SATA as HotSpare	E		• 32 GB DDR4 SDRAM (2 × 16 GB), ECC, dual channel, (only with Xeon processor) ¹⁾
• RAID1, 2 x 2 TB HDD [Enterprise] 3.5" SATA + 480 GB 2.5" SSD SATA (for operating system if M.2 SSD not ordered)	F		• 64 GB DDR4 SDRAM (4 × 16 GB), ECC, dual channel, (only with Xeon processor) ¹⁾
SSD			
• 480 GB SSD 2.5" SATA	P		Software installation
• 960 GB SSD 2.5" SATA	Q		• PCS 7 V9.1 pre-installed
• 1920 GB SSD 2.5" SATA	R		
• RAID1, 2 x 480 GB SSD 2.5" SATA	S		Operating system / Restore data storage medium / TPM
• RAID1, 2 x 960 GB SSD 2.5" SATA	T		• Windows 10 Enterprise 2019 LTSC, MUI (en, de, fr, it, sp, ch), 64-bit, without Restore USB flash drive
• RAID1, 2 x 1920 GB SSD 2.5" SATA	U		• Windows 10 Enterprise 2019 LTSC, MUI (en, de, fr, it, sp, ch), 64-bit, without Restore USB flash drive, TPM 2.0 (not for China)
• RAID5, approx. 3.8 TB (3 x 1920 GB SSD 2.5" SATA)	V		• Windows 10 Enterprise 2019 LTSC, MUI (en, de, fr, it, sp, ch), 64-bit, with Restore USB flash drive
• RAID5, approx. 5.7 TB (4 x 1920 GB SSD 2.5" SATA) ²⁾	W		• Windows 10 Enterprise 2019 LTSC, MUI (en, de, fr, it, sp, ch), 64-bit, with Restore USB flash drive, TPM 2.0 (not for China)
Without drives³⁾	X		

Ordering data (continued)

	Article No.		Article No.
SIMATIC Process Control System - IPC847E For ES/OS single station, OS client	6ES7661-		SIMATIC Process Control System - IPC847E For OS Server, Engineering Server, Web Server
(RACK PC, 19", 4 U) Interfaces: 3 x Gbps Ethernet (IE/PN, RJ45); 1 x DVI-D; 2 x DisplayPort; 1 x COM (RS 232, 9-pin); audio; 4 x USB3.1 Gen2 (Type A), 2 x USB3.1 Gen2 (Type C) on the rear side; 2 x USB3.1 Gen 1 (Type A) on the front; 1 x USB3.1 Gen2 (Type A) internal Temperature and fan monitoring, watchdog, card retainer	1		(RACK PC, 19", 4 U) Interfaces: 3 x Gbps Ethernet (IE/PN, RJ45); 1 x DVI-D; 2 x DisplayPort; 1 x COM (RS 232, 9-pin); audio; 4 x USB3.1 Gen2 (Type A), 2 x USB3.1 Gen2 (Type C) on the rear side; 2 x USB3.1 Gen 1 (Type A) on the front; 1 x USB3.1 Gen2 (Type A) internal Temperature and fan monitoring, watchdog, card retainer
Bus module / Communication / Multi-monitor			Processor and system type
• Bus module 11-slot: 3 x PCI, 1 x PCIe x16 (8 L), 5 x PCIe x16 (4 L), 2 x PCIe x4 (4 L)		A	<u>Core i5-8500 (6C/6T, 3.0 (4.1) GHz, 9 MB cache, TB, AMT)</u>
• Bus module 11-slot: 3 x PCI, 1 x PCIe x16 (8 L), 5 x PCIe x16 (4 L), 2 x PCIe x4 (4 L), multi-monitor 4–5 screens, combined, onboard interfaces (2 x DP) + PCIe x16 graphics card (3 x mDP: 3 x adapter mDP on DP), 2 GB (1 slot occupied)		B	• Core i5-8500 (6C/6T, 3.0 (4.1) GHz, 9 MB cache, TB, AMT) - PCS 7 OS Server, Engineering Server, Web Server ¹⁾
• Bus module 11-slot: 3 x PCI, 1 x PCIe x16 (8 L), 5 x PCIe x16 (4 L), 2 x PCIe x4 (4 L), BCE		C	<u>Core i7-8700 (6C/12T, 3.2 (4.6) GHz, 12 MB cache, TB, AMT)</u>
• Bus module 11-slot: 3 x PCI, 1 x PCIe x16 (8 L), 5 x PCIe x16 (4 L), 2 x PCIe x4 (4 L), BCE, multi-monitor 4–5 screens, combined, onboard interfaces (2 x DP) + PCIe x16 graphics card (3 x mDP: 3 x adapter mDP on DP), 2 GB (1 slot occupied)		D	• Core i7-8700 (6C/12T, 3.2 (4.6) GHz, 12 MB cache, TB, AMT) - PCS 7 OS Server, Engineering Server, Web Server ¹⁾
• Bus module 11-slot: 3 x PCI, 1 x PCIe x16 (8 L), 5 x PCIe x16 (4 L), 2 x PCIe x4 (4 L), Industrial Ethernet (CP1623), (1 slot occupied)		E	<u>Xeon E-2176G (6C/12T, 3.7 (4.7) GHz, 12 MB cache, TB, AMT)</u>
• Bus module 11-slot: 3 x PCI, 1 x PCIe x16 (8 L), 5 x PCIe x16 (4 L), 2 x PCIe x4 (4 L), Industrial Ethernet (CP1623), (1 slot occupied), multi-monitor 4–5 screens, combined, onboard interfaces (2 x DP) + PCIe x16 graphics card (3 x mDP: 3 x adapter mDP on DP), 2 GB (1 slot occupied)		F	• Xeon E-2176G (6C/12T, 3.7 (4.7) GHz, 12 MB cache, TB, AMT) - PCS 7 OS Server, Engineering Server, Web Server
Power supply / power supply cord			<u>Xeon E-2278GE (8C/16T, 3.3 (4.7) GHz, 16 MB cache, TB, AMT)</u>
• 100/240 V AC industrial power supply			• Xeon E-2278GE (8C/16T, 3.3 (4.7) GHz, 16 MB cache, TB, AMT) - PCS 7 OS Server, Engineering Server, Web Server
- Without power supply cord		0	Drives:
- Power supply cord for Europe		1	(HDD)
- Power supply cord for USA		2	• 1 TB HDD [Enterprise] 3.5" SATA
- Power supply cord for China		3	• 2 TB HDD [Enterprise] 3.5" SATA
• 2 x 100/240 V AC redundant industrial power supply unit		4	• RAID1, 2 x 1 TB HDD [Enterprise] 3.5" SATA
- Without power supply cord		4	• RAID1, 2 x 2 TB HDD [Enterprise] 3.5" SATA
- Power supply cord for Europe		5	• RAID1, 2 x 2 TB HDD [Enterprise] 3.5" SATA + 2 TB HDD [Enterprise] 3.5" SATA as HotSpare
- Power supply cord for USA		6	• RAID1, 2 x 2 TB HDD [Enterprise] 3.5" SATA + 480 GB 2.5" SSD SATA (for operating system if M.2 SSD not ordered)
- Power supply cord for China		7	<u>HW RAID, SAS</u>
			• RAID1, 2 x 2 TB HDD [Enterprise] 3.5" SAS; PCIe x8 RAID controller incl. ZMCP module (1 slot occupied) ²⁾
			• RAID1, 2 x 2 TB HDD [Enterprise] 3.5" SAS; PCIe x8 RAID controller incl. ZMCP module (1 slot occupied) + 480 GB SSD 2.5" SATA ²⁾
			• RAID5, 4 TB (3 x 2 TB HDD [Enterprise] 3.5" SAS); PCIe x8 RAID controller incl. ZMCP module (1 slot occupied) ²⁾
			• RAID5, 4 TB (3 x 2 TB HDD [Enterprise] 3.5" SAS) + 2 TB HDD [Enterprise] 3.5" SAS as HotSpare, PCIe x8 RAID controller incl. ZMCP module (1 slot occupied) ²⁾
			• RAID5, 6 TB (4 x 2 TB HDD [Enterprise] 3.5" SAS); PCIe x8 RAID controller incl. ZMCP module (1 slot occupied) ²⁾
			<u>SSD</u>
			• 480 GB SSD 2.5" SATA
			• 960 GB SSD 2.5" SATA
			• 1920 GB SSD 2.5" SATA
			• RAID1, 2 x 480 GB SSD 2.5" SATA

1) Selection criterion "Processor / System type", Position A, E, cannot be combined with selection criterion "Main memory", Position 5, 6, 7

2) Selection criterion "Drives", Position W, cannot be combined with selection criterion "Drive cage / M.2 memory", Position 0, 1, 2

3) Selection criterion "Drives", Position X, cannot be combined with selection criterion "Drive cage / M.2 memory", Position 0, 4

SIMATIC PCS 7 system hardware

Process Control System IPC

SIMATIC Rack PC

IPC847E

Ordering data (continued)

	Article No.									
SIMATIC Process Control System - IPC847E For OS Server, Engineering Server, Web Server	6ES7661-									
(RACK PC, 19", 4 U) Interfaces: 3 x Gbps Ethernet (IE/PN, RJ45); 1 x DVI-D; 2 x DisplayPort; 1 x COM (RS 232, 9-pin); audio; 4 x USB3.1 Gen2 (Type A), 2 x USB3.1 Gen2 (Type C) on the rear side; 2 x USB3.1 Gen 1 (Type A) on the front; 1 x USB3.1 Gen2 (Type A) internal Temperature and fan monitoring, watchdog, card retainer	1									
• RAID1, 2 x 960 GB SSD 2.5" SATA									T	
• RAID1, 2 x 1920 GB SSD 2.5" SATA									U	
• RAID5, approx. 3.8 TB (3 x 1920 GB SSD 2.5" SATA)									V	
• RAID5, approx. 5.7 TB (4 x 1920 GB SSD 2.5" SATA) ⁴⁾									W	
Without drives ³⁾									X	
Drive cage / M.2 memory										
• Drive cage for internal installation, 0.5 g vibration, 5 g shock ²⁾³⁾⁴⁾									0	
• Drive cage for internal installation, 0.5 g vibration, 5 g shock, 512 GB SSD M.2 NVMe on PCIe x4 adapter card (1 slot occupied) (for operating system) ²⁾⁴⁾									1	
• Drive cage for internal installation, 0.5 g vibration, 5 g shock, 1024 GB SSD M.2 NVMe on PCIe x4 adapter card (1 slot occupied) (for operating system) ²⁾⁴⁾									2	
• Drive cage for removable trays, on the front ³⁾									4	
• Drive cage for removable trays, on the front, 512 GB SSD M.2 NVMe on PCIe x4 adapter card (1 slot occupied) (for operating system)									5	
• Drive cage for removable trays, on the front, 1024 GB SSD M.2 NVMe on PCIe x4 adapter card (1 slot occupied) (for operating system)									6	
Main memory										
• 8 GB DDR4 SDRAM (2 x 4 GB), dual channel									0	
• 16 GB DDR4 SDRAM (2 x 8 GB), dual channel									1	
• 32 GB DDR4 SDRAM (2 x 16 GB), dual channel									2	
• 64 GB DDR4 SDRAM (4 x 16 GB), dual channel									3	
• 128 GB DDR4 SDRAM (4 x 32 GB), dual channel									4	
• 16 GB DDR4 SDRAM (2 x 8 GB), ECC, dual channel, (only with Xeon processor) ¹⁾									5	
• 32 GB DDR4 SDRAM (2 x 16 GB), ECC, dual channel, (only with Xeon processor) ¹⁾									6	
• 64 GB DDR4 SDRAM (4 x 16 GB), ECC, dual channel, (only with Xeon processor) ¹⁾									7	
Software installation										
• PCS 7 V9.1 pre-installed									1	
Operating system / Restore data storage medium / TPM										
• Windows Server 2019 Standard Edition incl. 16-core, 5 clients, 64-bit, MUI (en, de, fr, it, sp, ch), without Restore USB flash drive									P	
• Windows Server 2019 Standard Edition incl. 16-core, 5 clients, 64-bit, MUI (en, de, fr, it, sp, ch), without Restore USB flash drive, TPM 2.0 (not for China)									Q	
• Windows Server 2019 Standard Edition incl. 16-core, 5 clients, 64-bit, MUI (en, de, fr, it, sp, ch), with Restore USB flash drive									R	
• Windows Server 2019 Standard Edition incl. 16-core, 5 clients, 64-bit, MUI (en, de, fr, it, sp, ch), with Restore USB flash drive, TPM 2.0 (not for China)									S	
SIMATIC Process Control System - IPC847E For OS Server, Engineering Server, Web Server	6ES7661-									
(RACK PC, 19", 4 U) Interfaces: 3 x Gbps Ethernet (IE/PN, RJ45); 1 x DVI-D; 2 x DisplayPort; 1 x COM (RS 232, 9-pin); audio; 4 x USB3.1 Gen2 (Type A), 2 x USB3.1 Gen2 (Type C) on the rear side; 2 x USB3.1 Gen 1 (Type A) on the front; 1 x USB3.1 Gen2 (Type A) internal Temperature and fan monitoring, watchdog, card retainer	1									
Bus module / Communication / Multi-monitor										
• Bus module 11-slot: 3 x PCI, 1 x PCIe x16 (8 L), 5 x PCIe x16 (4 L), 2 x PCIe x4 (4 L)										A
• Bus module 11-slot: 3 x PCI, 1 x PCIe x16 (8 L), 5 x PCIe x16 (4 L), 2 x PCIe x4 (4 L), multi-monitor 4-5 screens, combined, onboard interfaces (2 x DP) + PCIe x16 graphics card (3 x mDP: 3 x adapter mDP on DP), 2 GB (1 slot occupied)										B
• Bus module 11-slot: 3 x PCI, 1 x PCIe x16 (8 L), 5 x PCIe x16 (4 L), 2 x PCIe x4 (4 L), BCE										C
• Bus module 11-slot: 3 x PCI, 1 x PCIe x16 (8 L), 5 x PCIe x16 (4 L), 2 x PCIe x4 (4 L), BCE, multi-monitor 4-5 screens, combined, onboard interfaces (2 x DP) + PCIe x16 graphics card (3 x mDP: 3 x adapter mDP on DP), 2 GB (1 slot occupied)										D
• Bus module 11-slot: 3 x PCI, 1 x PCIe x16 (8 L), 5 x PCIe x16 (4 L), 2 x PCIe x4 (4 L), Industrial Ethernet (CP1623), (1 slot occupied)										E
• Bus module 11-slot: 3 x PCI, 1 x PCIe x16 (8 L), 5 x PCIe x16 (4 L), 2 x PCIe x4 (4 L), Industrial Ethernet (CP1623), multi-monitor 4-5 screens, combined, onboard interfaces (2 x DP) + PCIe x16 graphics card (3 x mDP: 3 x adapter mDP on DP), 2 GB (1 slot occupied)										F
Power supply / power supply cord										
• 100/240 V AC industrial power supply										
- Without power supply cord										0
- Power supply cord for Europe										1
- Power supply cord for USA										2
- Power supply cord for China										3
• 2 x 100/240 V AC redundant industrial power supply unit										
- Without power supply cord										4
- Power supply cord for Europe										5
- Power supply cord for USA										6
- Power supply cord for China										7

1) Selection criterion "Processor / System type", Position B, F, cannot be combined with selection criterion "Main memory", Position 5, 6, 7

2) Selection criterion "Drives", Position G, H, J, K, L, cannot be combined with selection criterion "Drive cage / M.2 memory", Position 0, 1, 2

3) Selection criterion "Drives", Position X, cannot be combined with selection criterion "Drive cage / M.2 memory", Position 0, 4

4) Selection criterion "Drives", Position W, cannot be combined with selection criterion "Drive cage / M.2 memory", Position 0, 1, 2

Ordering data (continued)**SIMATIC Process Control System IPC847E as spare part**

		Article No.			Article No.
SIMATIC Process Control System - IPC847E Spare part		6ES7661-			6ES7661-
		1			1
(RACK PC, 19", 4 U) Interfaces: 3 x Gbps Ethernet (IE/PN, RJ45) 1 x DVI-D; 2 x DisplayPort; 1 x COM (RS 232, 9-pin); audio; 4 x USB3.1 Gen2 (Type A), 2 x USB3.1 Gen2 (Type C) on the rear side; 2 x USB3.1 Gen 1 (Type A) on the front; 1 x USB3.1 Gen2 (Type A) internal Temperature and fan monitoring, watchdog, card retainer					
Processor and system type					
Core i5-8500 (6C/6T, 3.0 (4.1) GHz, 9 MB cache, TB, AMT) • Core i5-8500 (6C/6T, 3.0 (4.1) GHz, 9 MB cache, TB, AMT) - spare part ¹⁾		V			V
Core i7-8700 (6C/12T, 3.2 (4.6) GHz, 12 MB cache, TB, AMT) • Core i7-8700 (6C/12T, 3.2 (4.6) GHz, 12 MB cache, TB, AMT) - spare part ¹⁾		W			W
Xeon E-2176G (6C/12T, 3.7 (4.7) GHz, 12 MB cache, TB, AMT) • Xeon E-2176G (6C/12T, 3.7 (4.7) GHz, 12 MB cache, TB, AMT) - Spare part		X			X
Xeon E-2278GE (8C/16T, 3.3 (4.7) GHz, 16 MB cache, TB, AMT) • Xeon E-2278GE (8C/16T, 3.3 (4.7) GHz, 16 MB cache, TB, AMT) - Spare part		Y			
Drives:					
(HDD)					
• 1 TB HDD [Enterprise] 3.5" SATA		A			
• 2 TB HDD [Enterprise] 3.5" SATA		B			
• RAID1, 2 x 1 TB HDD [Enterprise] 3.5" SATA		C			
• RAID1, 2 x 2 TB HDD [Enterprise] 3.5" SATA		D			
• RAID1, 2 x 2 TB HDD [Enterprise] 3.5" SATA + 2 TB HDD [Enterprise] 3.5" SATA as HotSpare		E			
• RAID1, 2 x 2 TB HDD [Enterprise] 3.5" SATA + 480 GB 2.5" SSD SATA (for operating system if M.2 SSD not ordered)		F			
HW RAID, SAS					
• RAID1, 2 x 2 TB HDD [Enterprise] 3.5" SAS; PCIe x8 RAID controller incl. ZMCP module (1 slot occupied) ²⁾		G			
• RAID1, 2 x 2 TB HDD [Enterprise] 3.5" SAS; PCIe x8 RAID controller incl. ZMCP module (1 slot occupied) + 480 GB SSD 2.5" SATA ²⁾		H			
• RAID5, 4 TB (3 x 2 TB HDD [Enterprise] 3.5" SAS); PCIe x8 RAID controller incl. ZMCP module (1 slot occupied) ²⁾		J			
• RAID5, 4 TB (3 x 2 TB HDD [Enterprise] 3.5" SAS) + 2 TB HDD [Enterprise] 3.5" SAS as HotSpare, PCIe x8 RAID controller incl. ZMCP module (1 slot occupied) ²⁾		K			
• RAID5, 6 TB (4 x 2 TB HDD [Enterprise] 3.5" SAS); PCIe x8 RAID controller incl. ZMCP module (1 slot occupied) ²⁾		L			
SSD					
• 480 GB SSD 2.5" SATA		P			
• 960 GB SSD 2.5" SATA		Q			
• 1920 GB SSD 2.5" SATA		R			
• RAID1, 2 x 480 GB SSD 2.5" SATA		S			
• RAID1, 2 x 960 GB SSD 2.5" SATA		T			
• RAID1, 2 x 1920 GB SSD 2.5" SATA		U			
SIMATIC Process Control System - IPC847E Spare part					
(RACK PC, 19", 4 U) Interfaces: 3 x Gbps Ethernet (IE/PN, RJ45) 1 x DVI-D; 2 x DisplayPort; 1 x COM (RS 232, 9-pin); audio; 4 x USB3.1 Gen2 (Type A), 2 x USB3.1 Gen2 (Type C) on the rear side; 2 x USB3.1 Gen 1 (Type A) on the front; 1 x USB3.1 Gen2 (Type A) internal Temperature and fan monitoring, watchdog, card retainer					
Processor and system type					
• RAID5, approx. 3.8 TB (3 x 1920 GB SSD 2.5" SATA)		V			
• RAID5, approx. 5.7 TB (4 x 1920 GB SSD 2.5" SATA) ⁴⁾		W			
Without drives ³⁾		X			
Drive cage / M.2 memory					
• Drive cage for internal installation, 0.5 g vibration, 5 g shock ²⁾³⁾⁴⁾		0			
• Drive cage for internal installation, 0.5 g vibration, 5 g shock, 512 GB SSD M.2 NVMe on PCIe x4 adapter card (1 slot occupied) (for operating system) ²⁾⁴⁾		1			
• Drive cage for internal installation, 0.5 g vibration, 5 g shock, 1024 GB SSD M.2 NVMe on PCIe x4 adapter card (1 slot occupied) (for operating system) ²⁾⁴⁾		2			
• Drive cage for removable trays, on the front ³⁾		4			
• Drive cage for removable trays, on the front, 512 GB SSD M.2 NVMe (M.2 slot occupied) on PCIe x4 adapter card (1 slot occupied) (for operating system)		5			
• Drive cage for removable trays, on the front, 1024 GB SSD M.2 NVMe on PCIe x4 adapter card (1 slot occupied) (for operating system)		6			
Main memory					
• 8 GB DDR4 SDRAM (2 x 4 GB), dual channel		0			
• 16 GB DDR4 SDRAM (2 x 8 GB), dual channel		1			
• 32 GB DDR4 SDRAM (2 x 16 GB), dual channel		2			
• 64 GB DDR4 SDRAM (4 x 16 GB), dual channel		3			
• 128 GB DDR4 SDRAM (4 x 32 GB), dual channel		4			
• 16 GB DDR4 SDRAM (2 x 8 GB), ECC, dual channel, (only with Xeon processor) ¹⁾		5			
• 32 GB DDR4 SDRAM (2 x 16 GB), ECC, dual channel, (only with Xeon processor) ¹⁾		6			
• 64 GB DDR4 SDRAM (4 x 16 GB), ECC, dual channel, (only with Xeon processor) ¹⁾		7			
Software installation					
• Without pre-installation		8			
Operating system / Restore data storage medium / TPM					
• Windows 10 Enterprise 2019 LTSC, MUI (en, de, fr, it, sp, ch), 64-bit, without Restore USB flash drive ²⁾		A			
• Windows 10 Enterprise 2019 LTSC, MUI (en, de, fr, it, sp, ch), 64-bit, without Restore USB flash drive, TPM 2.0 (not for China) ²⁾		B			
• Windows 10 Enterprise 2019 LTSC, MUI (en, de, fr, it, sp, ch), 64-bit, with Restore USB flash drive ²⁾		C			
• Windows 10 Enterprise 2019 LTSC, MUI (en, de, fr, it, sp, ch), 64-bit, with Restore USB flash drive, TPM 2.0 (not for China) ²⁾		D			
• Windows Server 2019 Standard Edition incl. 16-core, 5 clients, 64-bit, MUI (en, de, fr, it, sp, ch), without Restore USB flash drive		P			

SIMATIC PCS 7 system hardware

Process Control System IPC

SIMATIC Rack PC

IPC847E

Ordering data (continued)

	Article No.						
SIMATIC Process Control System - IPC847E Spare part	6ES7661-						
(RACK PC, 19", 4 U) Interfaces: 3 x Gbps Ethernet (IE/PN, RJ45) 1 x DVI-D; 2 x DisplayPort; 1 x COM (RS 232, 9-pin); audio; 4 x USB3.1 Gen2 (Type A), 2 x USB3.1 Gen2 (Type C) on the rear side; 2 x USB3.1 Gen 1 (Type A) on the front; 1 x USB3.1 Gen2 (Type A) internal Temperature and fan monitoring, watchdog, card retainer	1						
• Windows Server 2019 Standard Edition incl. 16-core, 5 clients, 64-bit, MUI (en, de, fr, it, sp, ch), without Restore USB flash drive, TPM 2.0 (not for China)							Q
• Windows Server 2019 Standard Edition incl. 16-core, 5 clients, 64-bit, MUI (en, de, fr, it, sp, ch), with Restore USB flash drive							R
• Windows Server 2019 Standard Edition incl. 16-core, 5 clients, 64-bit, MUI (en, de, fr, it, sp, ch), with Restore USB flash drive, TPM 2.0 (not for China)							S
• Without operating system, without Restore USB flash drive							X
Bus module / Communication / Multi-monitor							
• Bus module 11-slot: 3 x PCI, 1 x PCIe x16 (8 L), 5 x PCIe x16 (4 L), 2 x PCIe x4 (4 L)							A
• Bus module 11-slot: 3 x PCI, 1 x PCIe x16 (8 L), 5 x PCIe x16 (4 L), 2 x PCIe x4 (4 L), multi-monitor 4–5 screens, combined, onboard interfaces (2 x DP) + PCIe x16 graphics card (3 x mDP: 3 x adapter mDP on DP), 2 GB (1 slot occupied)							B
• Bus module 11-slot: 3 x PCI, 1 x PCIe x16 (8 L), 5 x PCIe x16 (4 L), 2 x PCIe x4 (4 L), BCE							C
• Bus module 11-slot: 3 x PCI, 1 x PCIe x16 (8 L), 5 x PCIe x16 (4 L), 2 x PCIe x4 (4 L), BCE, multi-monitor 4–5 screens, combined, onboard interfaces (2 x DP) + PCIe x16 graphics card (3 x mDP: 3 x adapter mDP on DP), 2 GB (1 slot occupied)							D
• Bus module 11-slot: 3 x PCI, 1 x PCIe x16 (8 L), 5 x PCIe x16 (4 L), 2 x PCIe x4 (4 L), Industrial Ethernet (CP1623), (1 slot occupied)							E
• Bus module 11-slot: 3 x PCI, 1 x PCIe x16 (8 L), 5 x PCIe x16 (4 L), 2 x PCIe x4 (4 L), Industrial Ethernet (CP1623), multi-monitor 4–5 screens, combined, onboard interfaces (2 x DP) + PCIe x16 graphics card (3 x mDP: 3 x adapter mDP on DP), 2 GB (1 slot occupied)							F
Power supply / power supply cord							
• 100/240 V AC industrial power supply							
- Without power supply cord							0
- Power supply cord for Europe							1
- Power supply cord for USA							2
- Power supply cord for China							3
• 2 x 100/240 V AC redundant industrial power supply unit							
- Without power supply cord							4
- Power supply cord for Europe							5
- Power supply cord for USA							6
- Power supply cord for China							7

1) Selection criterion "Processor / System type", Position V, W, cannot be combined with selection criterion "Main memory", Position 5, 6, 7

2) Selection criterion "Drives", Position G, H, J, K, L, cannot be combined with selection criterion "Drive cage / M.2 memory", Position 0, 1, 2, or with selection criterion "Operating system / Restore data storage medium / TPM", position A, B, C, D

3) Selection criterion "Drives", Position X, cannot be combined with selection criterion "Drive cage / M.2 memory", Position 0, 4

4) Selection criterion "Drives", Position W, cannot be combined with selection criterion "Drive cage / M.2 memory", Position 0, 1, 2

Additional and expansion components

USB keyboard TKL-105 Color: black • Keyboard layout, German • Keyboard layout, US International	6AV6881-0AU14-0AA0 6AV6881-0AU14-1AA0
SIMATIC HMI USB mouse Optical mouse with scroll wheel and USB connection, color anthracite	6AV2181-8AT00-0AX0
Memory expansion • 4 GB DDR4 SDRAM (1 x 4 GB) • 8 GB DDR4 SDRAM (1 x 8 GB) • 16 GB DDR4 SDRAM (1 x 16 GB) • 32 GB DDR4 SDRAM (1 x 32 GB)	6ES7648-2AL60-0QA0 6ES7648-2AL70-0QA0 6ES7648-2AL80-0QA0 6ES7648-2AL81-0QA0
Retainer For locking the internal USB port	6ES7648-1AA00-0XK0
Tray for low-profile removable drive bay For 3.5" hard disk (SATA/SAS) or 2.5" SSD (SATA), without drive	6ES7648-0EH00-1BA0
Adapter cable • DisplayPort to DVI-D for onboard graphics • DisplayPort to VGA for onboard graphics • Mini-DisplayPort to VGA for graphics card • Mini-DisplayPort to DVI-D for graphics card • Mini-DisplayPort to DVI-D for graphics card (3 units per pack) • Mini-DisplayPort to DisplayPort for graphics card • Mini-DisplayPort to DisplayPort for graphics card (3 units per pack)	6ES7648-3AF00-0XA0 6ES7648-3AG00-0XA0 6ES7648-3AL00-0XA0 6ES7648-3AK00-0XA0 6ES7648-3AK00-1XA0 6ES7648-3AJ00-0XA0 6ES7648-3AJ00-1XA0
Power supply cord, 3 m, for Rack PCs • Europe (for Austria, Belgium, Finland, France, Germany, the Netherlands, Spain, Sweden) • For the UK • For Switzerland • For the USA • For Italy • For China	6ES7900-0AA00-0XA0 6ES7900-0BA00-0XA0 6ES7900-0CA00-0XA0 6ES7900-0DA00-0XA0 6ES7900-0EA00-0XA0 6ES7900-0FA00-0XA0
SIMATIC NET HARDNET IE S7 REDCONNECT PowerPack For communication with high-availability AS, see the "Communication" chapter, "Industrial Ethernet – System connection PCS 7 systems" section.	

Accessories**Power supply cord for Rack PC**

The SIMATIC PCS 7 preferred types are always delivered with a "European power supply cord". This can be used in Germany, France, Spain, Netherlands, Belgium, Sweden, Austria and Finland.

The country-specific versions listed in the Ordering data are required for other countries. The following picture shows the design of a number of power supply plugs:



Country-specific power supply cords for Rack PC

Tower kit for IPC847E

The tower kit enables conversion of a SIMATIC Process Control System IPC with Rack PC design to an industrial tower PC. A tower kit can be ordered as an accessory for the SIMATIC Process Control System IPC of the type IPC847E.



Tower kit for IPC847E

SIMATIC PCS 7 system hardware

Process Control System IPC

SIMATIC Microbox PC

Overview

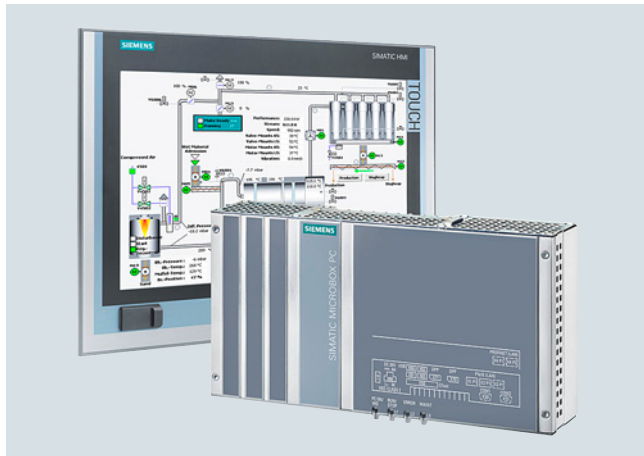

SIMATIC IPC427E and SIMATIC IPC477E family

Clients based on the rugged SIMATIC Microbox PC can be used within the SIMATIC PCS 7 process control system in the operator system and in SIMATIC BATCH. With their compact design, they are a space-saving alternative to clients based on a SIMATIC BOX PC or SIMATIC Rack PC for these applications. However, the numbers of expansion options and interfaces are comparatively lower.

Two designs are available:

- SIMATIC Process Control System Client IPC427E
Computing unit (without monitor) in compact metal enclosure, suitable for DIN rail and wall mounting, optional installation with portrait mounting kit
- SIMATIC Process Control System Client IPC477E
Built-in unit, consisting of 22" TFT single Touch Panel with integrated computing unit, suitable for installation in mounting cutouts such as in consoles or cabinets

Both designs are available with hard disk as well as solid state drive. Due to their exceptional physical properties, both versions are suitable for continuous maintenance-free 24/7 operation without the support of a fan.

For the SIMATIC Process Control System Client IPC427E, visualization of a project/subproject can be distributed to two process monitors connected to the onboard interfaces in multi-monitor mode. For the SIMATIC Process Control System Client IPC477E, process control is primarily via the integrated 22" display.

Technical specifications

Comparison of SIMATIC Process Control System Clients IPC427E and IPC477E

SIMATIC Process Control System Clients based on Microbox		
Types	SIMATIC Process Control System Client IPC427E	SIMATIC Process Control System Client IPC477E
Design and equipment features		
Design	<ul style="list-style-type: none"> • Compact Microbox PC without panel • DIN rail or wall mounting; horizontal (preferred) or vertical • Portrait mounting; vertical 	<ul style="list-style-type: none"> • Compact Panel PC, consisting of 22" TFT Single Touch Panel with integrated computing unit • Built-in unit for installation in mounting cutouts, for example in consoles or cabinets; in landscape format (vertical or max. ± 45° vertical incline) • Fastening with mounting clips or mounting brackets
Degree of protection in accordance with IEC 60529	IP20	IP65 on the front; IP20 on the rear side (enclosure)
CPU	Intel Core i5-6442EQ, 4C/4T, 1.9 (2.7) GHz, 6 MB cache, iAMT	Intel Core i5-6442EQ, 4C/4T, 1.9 (2.7) GHz, 6 MB cache, iAMT
Main memory	8 GB DDR4 SO-DIMM Max. 16 GB	8 GB DDR4 SO-DIMM Max. 16 GB
Graphic controller	Intel HD graphics controller	Intel HD graphics controller
Storage media, alternative		
<ul style="list-style-type: none"> • Hard disk • Solid State Drive 	2.5" SATA-HDD 320 GB 2.5" SATA-SSD 240 GB	2.5" SATA-HDD 320 GB 2.5" SATA-SSD 240 GB
Storage media, additive		
<ul style="list-style-type: none"> • CD-ROM/DVD-RW/diskette 	Connectable via USB (not included in scope of delivery)	Connectable via USB (not included in scope of delivery)
Interfaces		
<ul style="list-style-type: none"> • Ethernet • USB • Graphics connection • Keyboard, mouse 	3 Ethernet ports (RJ45); 10/100/1000 Mbps, isolated, with teaming capability 4 high-speed USB 3.0 ports 2 × DisplayPort Connectable via USB (keyboard and mouse not included in scope of delivery)	3 Ethernet ports (RJ45); 10/100/1000 Mbps, isolated, with teaming capability 4 high-speed USB 3.0 ports 2 × DisplayPort Connectable via USB (keyboard and mouse not included in scope of delivery)
Monitoring functions		
<ul style="list-style-type: none"> • Temperature monitoring • Watchdog • Status LEDs • Fan 	Yes Yes Yes No	– Yes – –
Monitoring function via the network	Optional	–

Technical specifications (continued)

SIMATIC Process Control System Clients based on Microbox		
Types	SIMATIC Process Control System Client IPC427E	SIMATIC Process Control System Client IPC477E
Operating system, basic software		
Operating system	Windows 10 Enterprise 2019 LTSC, 64-bit	Windows 10 Enterprise 2019 LTSC, 64-bit
System-tested SIMATIC industrial software	SIMATIC IPC DiagMonitor integrated in pre-installation	SIMATIC IPC DiagMonitor integrated in pre-installation
Electromagnetic compatibility (EMC)		
Interference emission over mains/AC power supply	EN 61000-6-3, EN 61000-6-4, CISPR 22 class B, FCC class A	EN 61000-6-3, EN 61000-6-4, CISPR 22 class B, FCC class A
Immunity to conducted interference on the supply lines	±2 kV (according to IEC 61000-4-4; burst) ±1 kV (according to IEC 61000-4-5; symmetrical surge) ±2 kV (according to IEC 61000-4-5; asymmetrical surge)	±2 kV (according to IEC 61000-4-4; burst) ±1 kV (according to IEC 61000-4-5; symmetrical surge) ±2 kV (according to IEC 61000-4-5; asymmetrical surge)
Noise immunity on signal lines	±1 kV (according to IEC 61000-4-4; burst; length < 3 m) ±2 kV (according to IEC 61000-4-4; burst; length > 3 m) ±2 kV (according to IEC 61000-4-5; surge; length > 30 m)	±1 kV (according to IEC 61000-4-4; burst; length < 3 m) ±2 kV (according to IEC 61000-4-4; burst; length > 3 m) ±2 kV (according to IEC 61000-4-5; surge; length > 30 m)
Immunity to static discharge in accordance with IEC 61000-4-2	±6 kV contact discharge ±8 kV air discharge	±6 kV contact discharge ±8 kV air discharge
Immunity to RF radiation	10 V/m for 80 to 1 000 MHz and 1.4 to 2 GHz, 80% AM in accordance with IEC 61000-4-3 3 V/m for 2 to 2.7 GHz, 80% AM in accordance with IEC 61000-4-3 10 V for 10 kHz to 80 MHz, 80% AM in accordance with IEC 61000-4-6	10 V/m for 80 to 1 000 MHz and 1.4 to 2 GHz, 80% AM in accordance with IEC 61000-4-3 3 V/m for 2 to 2.7 GHz, 80% AM in accordance with IEC 61000-4-3 10 V for 10 kHz to 80 MHz, 80% AM in accordance with IEC 61000-4-6
Immunity to magnetic fields at 50 Hz	100 A/m in accordance with IEC 61000-4-8	100 A/m in accordance with IEC 61000-4-8
Climatic conditions		
Ambient temperature in operation	0 to +50 °C	0 to +45 °C
Relative humidity • Operation • Storage	Tested according to IEC 60068-2-78, IEC 60068-2-30 5 ... 80% at 25 °C (no condensation) 5 ... 95% at 25 °C (no condensation)	Tested according to IEC 60068-2-78, IEC 60068-2-30 5 ... 80% at 25 °C (no condensation)
Mechanical ambient conditions		
Vibration load • Operation	Tested according to IEC 60068-2-6 10 ... 58 Hz: 0.075 mm 58 ... 200 Hz: 9.8 m/s ² (1 g)	Tested according to IEC 60068-2-6 5 ... 9 Hz: 3.5 mm; 9 ... 500 Hz: 9.8 m/s ² (with SSD); 10 ... 58 Hz 0.0375 mm; 58 ... 200 Hz: 4.9 m/s ² (hard disk)
Shock load • Operation	Tested according to IEC 60068-2-29 50 m/s ² (5 g), 30 ms, 100 shocks	Tested according to IEC 60068-2-27 50 m/s ² , 30 ms (with hard disk) 150 m/s ² , 11 ms (without hard disk)
Standards, approvals and certificates		
CE mark	Yes	Yes
CSA approval		Yes
UL approval • UL 508	Yes Yes	Yes Yes
cULus	Yes	Yes
RCM (formerly C-TICK)	Yes	Yes
KC certification	Yes	Yes
FCC	Yes	Yes
EMC • EN 61000-6-2	CE, EN 55022A, EN 61000-6-4, EN 61000-6-2 Yes	CE, EN 61000-6-4; CISPR 22:2004 class A; FCC class A
Dimensions		
Width × height × depth (in mm)	262 × 139.7 × 55.5	• 542 × 362 × 83 (installation dimensions, central configuration, no optical drive) • 542 × 362 × 76 (mounting cutout/device depth)
Operator panel (width × height in mm)	--	560 × 380

SIMATIC PCS 7 system hardware

Process Control System IPC
SIMATIC Microbox PC

OS Client IPC427E

Overview

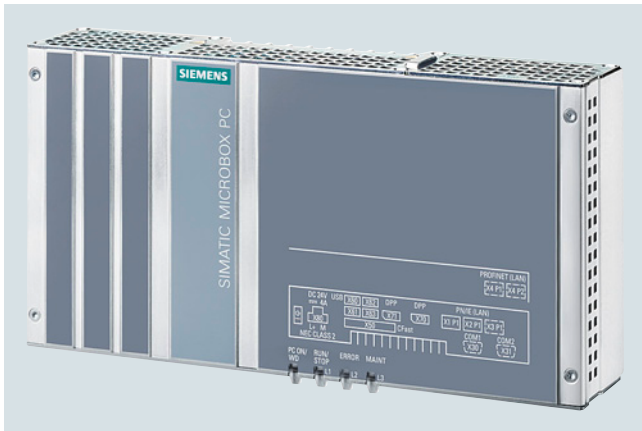

SIMATIC PCS 7 OS Client IPC427E

The SIMATIC Process Control System Client IPC427E is offered in two versions:

- SIMATIC Process Control System Client IPC427E (HDD)
With hard disk 2.5" SATA-HDD, 320 GB
- SIMATIC Process Control System Client IPC427E (SSD)
With solid state drive 2.5" SATA-SSD, 240 GB

Design

Both versions of the SIMATIC Process Control System Client IPC427E are suitable for continuous maintenance-free 24/7 operation without the support of a fan.

The absence of rotating storage media means that the SSD version is particularly resistant to vibration and shock. When operating in a restricted access location (RAL), e.g. in a lockable control cabinet, operating temperatures from 0 °C to +50 °C are permissible for this version in a horizontal mounting position.

The compact design of the SIMATIC Process Control System Client IPC427E (HDD/SSD) and the flexible mounting options (DIN rail, wall or portrait mounting) either horizontally or vertically facilitate space-saving installation.

Expansions/interfaces

The SIMATIC Process Control System Client IPC427E (HDD/SSD) features:

- 4 high-speed USB 3.0 ports
- 2 DisplayPorts (DVI with DPP-to-DVI adapter); can be used for multi-monitor mode with two screens
- 3 Gigabit Ethernet ports (IE/PN)

The integrated Ethernet ports are suitable for connection to a redundant terminal bus over IE-RNA (for details on implementation, refer to the function manual "High-availability process control systems", "Redundant, high availability terminal bus").

The SIMATIC Process Control System Client IPC427E (HDD/SSD) is supplied without input/output devices. In addition to mouse and keyboard, two other input/output devices can be externally connected via the provided USB ports, e.g. an optical drive (DVD-ROM/DVD±RW) or smart card reader.

Monitoring functions

Configurable monitoring functions can be recorded and evaluated via SIMATIC IPC DiagMonitor and SIMATIC PCS 7 Maintenance Station. These monitoring functions include:

- Program execution (watchdog)
- Processor and board temperatures
- Enhanced diagnostics/messages, e.g. operating hours counter, hard disk status or system status, back-up battery status

The "Power" and "Watchdog" signals are displayed on LEDs.

Pre-installed software

The following software is pre-installed on the SIMATIC Process Control System Client IPC427E (HDD/SSD) on delivery:

- Operating system Windows 10 Enterprise 2019 LTSC, 64-bit
- SIMATIC PCS 7 OS Software Client
- SIMATIC IPC DiagMonitor diagnostics software

Ordering data	Article No.	Accessories
<p>SIMATIC Process Control System Client 427E based on SIMATIC IPC427E SIMATIC IPC427E for use as SIMATIC PCS 7 OS Client/Batch Client</p> <p>Intel Core i5-6442EQ (up to 2.7 GHz, 6 MB cache); 8 GB work memory; 3 × Gigabit Ethernet (IE/PN); 4 × high-speed USB 3.0; 24 V DC power supply</p> <p>SIMATIC IPC DiagMonitor diagnostics software and Restore USB sets; SIMATIC PCS 7 OS Software Client V9.1 pre-installed</p> <p>Note: Product package without optical drive, mouse, keyboard or monitor</p> <p>Operating system Windows 10 Enterprise 2019 LTSC, 64-bit</p> <ul style="list-style-type: none"> • SIMATIC Process Control System Client IPC427E (HDD) Version with hard disk 320 GB, HDD SATA • SIMATIC Process Control System Client IPC427E (SSD) Version with 240 GB solid state drive, SSD SATA 	<p>6ES7650-0VG68-0YX0</p> <p>6ES7650-0VG68-0YX1</p>	<p>Portrait mounting kit</p> <p>The portrait assembly kit allows space-saving installation of the SIMATIC Microbox PC in the control cabinet. The technical specifications of the SIMATIC Microbox PC correspond in this design form to those with a vertical DIN rail assembly.</p> <p>Portrait mounting reduces the mounting area required (W × H in mm) from 262 × 133 to 61.5 × 315. Together with the kit, the SIMATIC Microbox PC occupies an installation depth of 149.7 mm in the control cabinet. Since all interfaces of the SIMATIC Microbox PC are accessible from the front, this type of assembly is very convenient for commissioning.</p> <p>When using the portrait assembly kit for the SIMATIC Microbox PC, please also note the information on operation planning and device installation in the "SIMATIC IPC427E industrial PC" manual.</p>
Additional and expansion components		
<p>SIMATIC IPC, graphics adapter cable, DVI-I to VGA Length 250 mm</p>	6ES7648-3AB00-0XA0	
<p>SIMATIC IPC, graphics adapter DPP to DVI Converts DisplayPort to DVI-D</p>	6ES7648-3AF00-0XA0	
Keyboard/mouse		
<p>USB keyboard TKL-105 Color: black</p> <ul style="list-style-type: none"> • Keyboard layout, German • Keyboard layout, US International 	<p>6AV6881-0AU14-0AA0</p> <p>6AV6881-0AU14-1AA0</p>	
<p>SIMATIC HMI USB mouse Optical mouse with scroll wheel and USB connection, color anthracite</p>	6AV2181-8AT00-0AX0	
Accessories		
Portrait mounting		
<p>Portrait mounting kit For space-saving installation of the SIMATIC PCS 7 OS Client 427E (on the front)</p>	6ES7648-1AA20-0YPO	

Technical specifications

For detailed technical specifications of the SIMATIC Process Control System Client IPC427E, see "Comparison of SIMATIC Process Control System Clients IPC427E and IPC477E" in the catalog section "SIMATIC Microbox PC".

SIMATIC PCS 7 system hardware

Process Control System IPC
SIMATIC Microbox PC

OS Client IPC477E

Overview

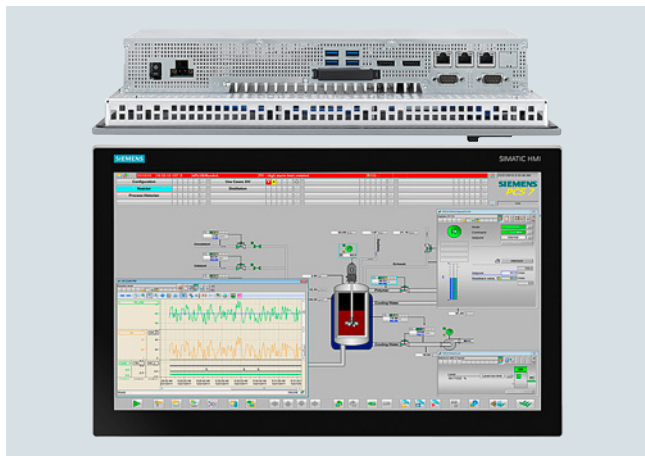

SIMATIC Process Control System Client IPC477E, from above and from front

The SIMATIC Process Control System Client IPC477E consists of a 22" TFT Single Touch Panel with an integrated computing unit. It is available in two versions.

- SIMATIC Process Control System Client IPC477E (HDD)
With hard disk, 2.5" SATA HDD, 320 GB
- SIMATIC Process Control System Client IPC477E (SSD)
With solid-state drive, 2.5" SATA SSD, 240 GB

Design

The design of the SIMATIC Process Control System Client IPC477E has been optimized for installation in the mounting cutouts of cabinets, enclosures and consoles.

Both versions of the SIMATIC Process Control System Client IPC477E are suitable for continuous maintenance-free 24/7 operation without the support of a fan.

The more rugged SIMATIC Process Control System Client IPC477E with SSD can bear greater mechanical loads. With vertical installation in landscape format, it is approved for operating temperatures of 0 to +45 °C.

Using a touch pen as an input tool protects the touch screen and makes it easy to achieve pin-point accuracy when operating small text boxes or buttons – especially when working with gloves.

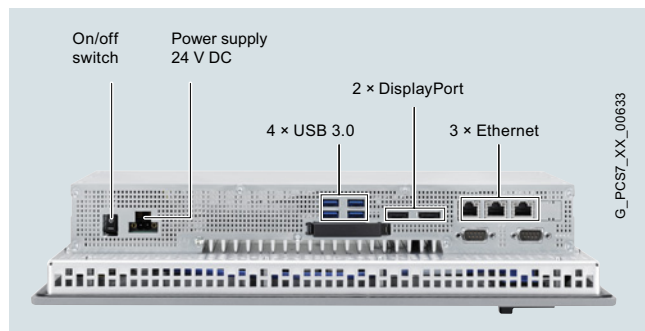

IPC477E, 22", for SIMATIC PCS 7, with connections

Expansions/interfaces

The SIMATIC Process Control System Client IPC477E (HDD/SSD) features:

- 4 high-speed USB 3.0 ports, on the rear side
- 1 USB port, on the front
- 2 DisplayPort interfaces
- 3 Gigabit Ethernet ports (1E/PN)

The integrated Ethernet ports are suitable for connection to a redundant terminal bus (for details on implementation, refer to the function manual "High-availability process control systems", "Redundant, high availability terminal bus").

The SIMATIC Process Control System Client IPC477E (HDD/SSD) is supplied without input/output devices. In addition to mouse and keyboard, two other input/output devices can be externally connected via the provided USB ports, e.g. an optical drive (DVD-ROM/DVD±RW) or smart card reader.

Monitoring functions

Configurable monitoring functions can be recorded and evaluated via SIMATIC IPC DiagMonitor and SIMATIC PCS 7 Maintenance Station. These monitoring functions include:

- Program execution (watchdog)
- Processor and board temperatures
- Enhanced diagnostics/messages, e.g. operating hours counter, hard disk status or system status, back-up battery status

Pre-installed software

The following software is pre-installed on the SIMATIC Process Control System Client IPC477E (HDD/SSD) on delivery:

- Operating system Windows 10 Enterprise 2019 LTSC, 64-bit
- SIMATIC PCS 7 OS Software Client
- SIMATIC IPC DiagMonitor diagnostics software

Ordering data	Article No.
SIMATIC Process Control System Client IPC477E based on SIMATIC IPC477E SIMATIC IPC477E for use as SIMATIC PCS 7 OS Client/BATCH Client 22" Single Touch Panel; 1920 x 1080 pixels; Intel Core i5-6442EQ (up to 2.7 GHz, 6 MB cache); 8 GB work memory; 3 x GB Ethernet (IE/PN); 4 x high-speed USB 3.0; 1 x USB 2.0; 24 V DC power supply SIMATIC IPC DiagMonitor diagnostics software and Restore USB flash drive; SIMATIC PCS 7 OS Software Client V9.1 pre-installed <u>Note:</u> Product package without optical drive, mouse or keyboard <u>Operating system Windows 10 Enterprise 2019 LTSC, 64-bit</u>	
<ul style="list-style-type: none"> • SIMATIC Process Control System Client IPC477E (HDD) Version with hard disk 320 GB, HDD SATA 	6ES7650-0VG68-1YX0
<ul style="list-style-type: none"> • SIMATIC Process Control System Client IPC477E (SSD) Version with 240 GB solid state drive, SSD SATA 	6ES7650-0VG68-1YX1

Additional and expansion components

USB keyboard TKL-105 Color: black <ul style="list-style-type: none"> • Keyboard layout, German • Keyboard layout, US International 	6AV6881-0AU14-0AA0 6AV6881-0AU14-1AA0
SIMATIC HMI USB mouse Optical mouse with scroll wheel and USB connection, color anthracite	6AV2181-8AT00-0AX0
Touch pen, thick, resistive technology For resistive touch screen, optimized for operation with gloves, including screw-on wall-mounting bracket	6AV7672-1JB00-0AA0

Technical specifications

For detailed technical specifications of the SIMATIC Process Control System Client IPC477E, see "Comparison of SIMATIC Process Control System Clients IPC427E and IPC477E" in the catalog section "SIMATIC Microbox PC".

SIMATIC PCS 7 system hardware

Process Control System IPC

Expansion components

Mouse and keyboard

Design

Mouse



SIMATIC Process Control System IPCs, SIMATIC PCS 7 compact systems as well as OS Clients based on SIMATIC Box/Microbox PC are delivered without a mouse. The SIMATIC HMI USB mouse is recommended as the input device for the operator-controlled stations of a SIMATIC PCS 7 system.

Keyboard



SIMATIC Process Control System IPCs, SIMATIC PCS 7 compact systems as well as OS Clients based on SIMATIC BOX and Microbox PC are delivered without a keyboard.

An example of a keyboard without additional special functions that is suitable for process mode with SIMATIC PCS 7 is the USB keyboard TKL-105.

The USB keyboard TKL-105 is a very rugged keyboard that is suitable even for harsh environments. Thanks to its IP68 degree of protection, the keyboard can even be washed (dishwasher-proof). The new black color fits optimally into all environments. The housing is made of ABS with anti-microbial coating. The long-travel keys ensure excellent tactile feel and fatigue-free typing.

Ordering data

Article No.

SIMATIC HMI USB mouse
Optical mouse with scroll wheel and USB connection, color anthracite

6AV2181-8AT00-0AX0

USB keyboard TKL-105

Color: black

- Keyboard layout, German
- Keyboard layout, US International

6AV6881-0AU14-0AA0

6AV6881-0AU14-1AA0

Technical specifications

Article number	6AV6881-0AU14-0AA0	6AV6881-0AU14-1AA0
	USB keyboard GER, TKL-105	USB keyboard INT, TKL-105
General information		
Product type designation	USB keyboard GERMAN	USB keyboard international US
Control elements		
Version of actuating element	Long-stroke key with 4 mm contact travel	Long-stroke key with 4 mm contact travel
Operating principle of the actuating element	Keyboard with long-stroke keys with membrane switching contacts	Keyboard with long-stroke keys with membrane switching contacts
Input device		
• Scroll wheel	No	No
• Movement tracking	none	none
Keyboard fonts		
• Design	Keyboard with long-stroke keys	Keyboard with long-stroke keys
• Keyboard assignment	105 keys, German layout	105 keys, international US layout
• Color of the buttons	Black	Black
• Color of the key inscription	White	White
• Key illumination	No	No
• Function keys	Yes	Yes
- Number of function keys	12	12
- Number of function keys with LEDs	0	0
- Programmable	No	No
• Number pad	Yes; Free-standing	Yes; Free-standing
• status LED displays	Yes; Num, Caps and Scroll	Yes; Num, Caps and Scroll
- for number pad	Yes	Yes
- for Shift keys	Yes	Yes
Connection type		
• USB	Yes; USB 2.0 type A	Yes; USB 2.0 type A
• PS/2	No	No
• Cable length	0 m; See cable length	0 m; See cable length
Frame size/design		
• Standard	Yes; For industrial applications	Yes; For industrial applications
Installation type/mounting		
Mounting	Desktop	Desktop
Mounting type	none	none
Supply voltage		
Rated value (DC)	5 V; via USB	5 V; via USB
Battery		
Battery-operated	No; maintenance-free	No; maintenance-free
Interfaces		
Number of USB interfaces	1; USB 2.0	1; USB 2.0
Degree and class of protection		
IP (all-round)	IP68 all-round and dishwasher safe	IP68 all-round and dishwasher safe
IP (at the front)	USB connector without degree of protection	USB connector without degree of protection
Standards, approvals, certificates		
CE mark	Yes	Yes
cULus	Yes; cUL	Yes; cUL
BIS	No; required for export to India	No; required for export to India

SIMATIC PCS 7 system hardware

Process Control System IPC

Expansion components

Mouse and keyboard**Technical specifications**

Article number	6AV6881-0AU14-0AA0	6AV6881-0AU14-1AA0
	USB keyboard GER, TKL-105	USB keyboard INT, TKL-105
Ambient conditions		
Suited for indoor use	Yes	Yes
Suited for outdoor use	No; possible under certain conditions	No; possible under certain conditions
Ambient temperature during operation		
• min.	0 °C	0 °C
• max.	70 °C	70 °C
Relative humidity		
• Operation, max.	80 %; no condensation	80 %; no condensation
• Condensation permissible	No	No
Runs under operating system		
• Windows CE	Yes	Yes
• Windows Vista	Yes	Yes
• Windows XP	Yes	Yes
• Windows 7	Yes	Yes
• Windows 8	Yes	Yes
• Windows 10	Yes	Yes
Cables		
Cable length	1.5 m; USB	1.5 m; USB
Mechanics/material		
Material		
• Plastic	Yes; Black	Yes; Black
Enclosure material (front)		
• Plastic	Yes; ABS with antimicrobial coating	Yes; ABS with antimicrobial coating
Enclosure color (front)	Black	Black
Enclosure color (rear)	Black	Black
Torques/forces		
• Breakdown torque	0.53 N·m; Switching force buttons	0.53 N·m; Switching force buttons
Service life		
• Number of operating cycles, keys	10 000 000; Operations (minimum)	10 000 000; Operations (minimum)
Dimensions		
Width	459 mm	459 mm
Height	35 mm	35 mm
Depth	174 mm	174 mm
Weights		
Weight without packaging	800 g	800 g
Scope of supply		
Delivery quantity in pieces	1	1
Other		
printable with laser printer	No; Layout change possible, one-off costs around € 2 000	No; Layout change possible, one-off costs around € 2 000
Merchandise	Yes; GETT TKL-105	Yes; GETT TKL-105
Manufacturer name	GETT Gerätetechnik GmbH	GETT Gerätetechnik GmbH
Manufacturer's address	Mittlerer Ring 1, 08233 Treuen (Vogtland), Germany	Mittlerer Ring 1, 08233 Treuen (Vogtland), Germany
contacting the manufacturer	Phone +49 37468 660-0, email: info@gett.de	Phone +49 37468 660-0, email: info@gett.de
Target devices	For SIMATIC HMI devices and IPCs with the appropriate slot	For SIMATIC HMI devices and IPCs with the appropriate slot
Note:	Corresponds to KL21203	Corresponds to KL24603

Overview



A smart card reader can be used to check operator privileges on a Single Station or Client. The smart card reader works with SIMATIC Logon, the user administration and access control function integrated in SIMATIC PCS 7 (see section "Industrial Security", paragraph "SIMATIC Logon").

The smart card has the function of a "key" for the operator station. Inputs are only permissible as long as it is inserted in the reader. Such unambiguous identification is particularly necessary for plants having to comply with validation requirements.

Ordering data

Article No.

USB smart card reader

Desktop unit with USB connecting cable

6ES7652-0XX02-1XC0

SIMATIC PCS 7 TCOS 3.0 chip card for chip card reader

Pack with 10 units; 1 card is required per user

6ES7652-0XX00-1XD2

Technical specifications

Type	USB smart card reader
Interface	
Interface type	USB 2.0 CCID (Chip Card Interface Device), USB 1.1 compatible
Transmission rate	12 Mbps
Power supply	Via USB
Design and equipment	
Design	Desktop unit with foot for vertical positioning; adhesive pad at rear for optional mounting
Material	ABS
Color	Two shades of gray
Status display	Two-color LED
Connecting cable length	1.8 m
Dimensions and weights	
Dimensions (L x W x D in mm)	80 x 67 x 28
Weight without foot	110 g
Weight with foot	141 g
Ambient conditions in operation	
Temperature	0 ... 55 °C
Humidity	10 ... 90 %
Service life/MTBF	
Insertion cycles	100 000
MTBF (Mean Time Between Failures)	500 000 h
Test symbols / certifications	
	<ul style="list-style-type: none"> • Microsoft WHQL (Windows Hardware Quality Lab) • ISO 7816 • USB 2.0 (USB 1.1 compatible) • CCID (Chip Card Interface Device) • GSA Fips201 approved product list
Safety/environmental standards	
	<ul style="list-style-type: none"> • CE • WEEE • FCC • UL • VCCI • MIC • RoHS

SIMATIC PCS 7 system hardware

Process Control System IPC

Expansion components

Input tools

Overview



Touch pen, thick, incl. wall bracket for screw mounting

Touch pens are effective input tools for operating the touch screen, and are especially helpful when working with gloves or under extreme ambient conditions.

You can use the touch pen to operate small buttons and input boxes with pint-point accuracy and also avoid scratches and soiling.

The thick touch pen for resistive touch screens offered here is suitable for all SIMATIC PCS 7 OS Clients and SIMATIC PCS 7 compact systems with TFT touch panels:

- PCS 7 OS Client IPC477E
- SIMATIC PCS 7 BOX in Design Version with Panel Front

Ordering data

Article No.

Touch pen, thick, resistive technology

For resistive touch screen, optimized for operation with gloves, including screw-on wall-mounting bracket

6AV7672-1JB00-0AA0

Technical specifications

Article number	6AV7672-1JB00-0AA0	6AV2181-8AV20-0AX0	6AV2181-8AV60-0AX0	6AV6645-7AB14-0AS1
	Touch pen, thick, resistive	Touch pen system	Touch pen caps	Touch pen, thin, ALU resistive
General information				
Product type designation	Touch pen, thick, resistive technology	Touch pen system capacitive technology	Touch pen caps	Touch pen, thin, ALU resistive
Frame size/design				
• Standard	Yes; For industrial applications	Yes; For industrial applications	Yes; Special cap for capacitive touch pens	Yes; For industrial applications
• Exceptional		Yes; Spare caps can be stowed in the pen		
• Ergonomic	Yes; With holder	Yes; With holder		
Installation type/mounting				
Mounting type		Wall-mounting bracket can be mounted with mounting disk, 2x M3 screw or adhesive pads		
Front mounting		Yes; also optimized for PRO Extension Unit 22.5 mm opening (from HS01))		
Wall mounting/direct mounting	Yes; Screw-on clamping holder and elastic attachment cord	Yes	Yes; Capacitive touch system	Yes; using 40 cm retaining cord
Degree and class of protection				
IP (at the front)		IP65 (depending on mounting)		
Ambient conditions				
Suited for indoor use		Yes		Yes
Suited for outdoor use		Yes; only suitable under certain conditions due to different environmental conditions; replacement cycle can be increased	Yes; only suitable under certain conditions due to different environmental conditions; replacement cycle can be increased	Yes

Technical specifications (continued)

Article number	6AV7672-1JB00-0AA0	6AV2181-8AV20-0AX0	6AV2181-8AV60-0AX0	6AV6645-7AB14-0AS1
	Touch pen, thick, resistive	Touch pen system	Touch pen caps	Touch pen, thin, ALU resistive
Ambient temperature during operation				
• min.	-40 °C; at temperatures below 10 °C and above 30 °C, the use of suitable gloves is recommended	-40 °C; at temperatures below 10 °C and above 30 °C, the use of suitable gloves is recommended	-40 °C; at temperatures below 10 °C and above 30 °C, the use of suitable gloves is recommended	-40 °C
• max.	80 °C	80 °C; at temperatures below 10 °C and above 30 °C, the use of suitable gloves is recommended	80 °C; at temperatures below 10 °C and above 30 °C, the use of suitable gloves is recommended	80 °C
Relative humidity				
• Operation, max.	90 %	95 %	95 %	90 %
Mechanics/material				
Material				
• Plastic	Yes; Touch pen SIMATIC HMI	Yes; Attachment cord	Yes	
• Aluminum		Yes; Touch pen, wall-mounting bracket		Yes; pen, anodized
• Stainless steel	Yes; Mounting			
Screw type				
• Torx	Yes			
Dimensions				
Length	155 mm	150 mm	8 mm	125 mm
Diameter	20 mm	14 mm	8 mm	8 mm
Enclosure diameter		37 mm; Diameter wall-mounting bracket		
Mounting cutout, height		39 mm; Height wall-mounting bracket		
Weights				
Weight without packaging		0,13 kg	0,8 g	
Scope of supply				
Delivery quantity in pieces	1; Optional for Extension Units of the PRO devices	1; 1x touch pen with string, wall-mounting bracket, M6 screw, mounting disk, O-ring, adhesive pads, spare caps for touch pen	10; Caps for touch pen	5; Incl. retaining cord for Mobile Panel 277 10"
Other				
Merchandise	No	Yes; Function depending on touch sensitivity, not suitable for Ceran cooktops, MP377 Daylight, possibly others	Yes; Function depending on touch sensitivity, not suitable for Ceran cooktops, MP377 Daylight, possibly others	Yes
Manufacturer name	SIEMENS	QUERUM products UG	QUERUM products UG	QUERUM products UG
Manufacturer's address	Gleiwitzerstraße 555, 90475 Nuremberg, Germany	Wirtsstr. 23, 85110 Kipfenberg-Böhming, Germany	Wirtsstr. 23, 85110 Kipfenberg-Böhming, Germany	Wirtsstr. 23, 85110 Kipfenberg-Böhming, Germany
Target devices	for resistive touch screens, optimized for operating while wearing gloves	For common capacitive and resistive touch systems	For common capacitive and resistive touch systems	for resistive touch screens
Note:		Length of the interconnecting lead 53 cm to 100 cm	only usable for touch pen 6AV2181-8AV20-0AX0	

SIMATIC PCS 7 system hardware

Notes

12

Automation systems



13/2	Introduction
13/4	AS 410-5H and AS 410E modular systems
13/10	Standard automation systems
13/14	High-availability automation systems
13/20	Safety-related automation systems
13/28	Complementary S7-400 systems
13/31	Standard automation systems
13/35	High-availability automation systems
13/40	Safety-related automation systems
13/45	SIPLUS automation systems

SIMATIC PCS 7 system hardware

Automation systems

Introduction

Overview



SIMATIC PCS 7 automation systems in various designs:
Modular S7-400 systems plus Microbox system

Automation systems are available in different designs for the SIMATIC PCS 7 process control system. The automation performance can therefore be finely scaled within wide limits.

The automation systems offered can be classified as follows:

- Modular systems of the S7-400 series with hardware controller in the versions "Standard", "High availability" and "Safety-related"
 - AS 410-5H/AS 410E automation systems
 - Complementary S7-400 systems

Application

Automation system with APL	AS 412H	AS 414-3	AS 414-3IE	AS 414H	AS 416-2	AS 416-3	AS 416-3IE	AS 416H	AS 417-4	AS 417H
	AS 410 with CPU 410-5H									
	AS 410E ¹⁾									
Analog value measurements	10	150	150	100	300	500	500	400	800	600
Digital value measurements	20	300	300	250	600	1 000	1 000	800	1 400	1 000
PID controls	5	50	50	50	100	200	200	150	250	200
Motors	7	75	75	75	150	250	250	200	450	400
Valves	7	75	75	75	150	250	250	200	450	400
SFC	0	15	15	15	60	100	100	100	200	200
Steps	0	150	150	150	700	1 000	1 000	1 000	2 000	2 000
Dosing	0	5	5	3	20	25	25	25	50	50
Digital inputs DI	30	450	450	300	900	1 500	1 500	1 200	2 200	1 800
Digital outputs DO	10	150	150	110	300	500	500	400	750	650
Analog inputs AI	15	225	225	150	450	750	750	600	1 100	900
Analog outputs AO	5	75	75	50	150	250	250	200	350	350
Process objects (PO)	30	450	450	350	900	1 500	1 500	1 200	2 200	2 000

Typical mixed configuration limits for SIMATIC PCS 7 automation systems, based on the SIMATIC PCS 7 Advanced Process Library (APL)

¹⁾ Up to 200 process objects

Note:

The values quoted here are not AS-specific maximum values for the particular item. Instead, they represent a typical distribution of the available total capacity of the AS during mixed operation of all the items of a contiguous block.

The number of process objects is not an absolute value, but depends on the library used as well as on the number and type of blocks used in the application.

Application (continued)**Modular automation systems of the S7-400 range**

AS type	CPU	Interfaces			
		PN/IE (2 ports)	MPI/DP	DP	DP module as optional plug-in
Standard systems					
AS 410S	CPU 410-5H Process Automation and CPU 410E	2	–	1	–
AS 414-3	CPU 414-3	–	1	1	1
AS 414-3IE	CPU 414-3 PN/DP	1	1	–	1
AS 416-2	CPU 416-2	–	1	1	–
AS 416-3	CPU 416-3	–	1	1	1
AS 416-3IE	CPU 416-3 PN/DP	1	1	–	1
AS 417-4	CPU 417-4	–	1	1	2
High availability and safety-oriented systems					
AS 410H/F/FH	CPU 410-5H Process Automation and CPU 410E (1 × or 2 ×)	2	–	1	–
AS 412H/F/FH	CPU 412-5H (1 × or 2 ×)	1	1	1	–
AS 414H/F/FH	CPU 414-5H (1 × or 2 ×)	1	1	1	–
AS 416H/F/FH	CPU 416-5H (1 × or 2 ×)	1	1	1	–
AS 417H/F/FH	CPU 417-5H (1 × or 2 ×)	1	1	1	–

The rugged automation systems of the S7-400 series are suitable for universal use. They are characterized by high processing and communication performance. The product range offered basically differs in the following features:

- **AS 410-5H/AS 410E automation systems**
 - Preferred systems for new plants with SIMATIC PCS 7
 - Suitable for SIMATIC PCS 7 as of V8.0+SP1¹⁾ or as of V9.0 (AS 410E)
 - Standard systems, fault-tolerant systems, and safety-oriented systems are based on the very same CPU
 - Performance of the general-purpose CPU 410-5H is scalable and expandable based on the number of process objects
 - Changes in the type of module during operation (TCiR) possible together with the SIMATIC PCS 7 Engineering System V8.1 and higher
 - Redundant PROFINET configurations and configuration changes during operation for PROFINET in singular and redundant applications
- **Complementary S7-400 systems**
 - Can be used in plants with SIMATIC PCS 7 V8/V7
 - As an alternative to AS 410-5H/AS 410E, primarily in systems with SIMATIC PCS 7 V7
 - Scalable based on types of CPU differing in performance

The CPU for all automation systems of the S7-400 series is already equipped as standard with the PROFIBUS DP fieldbus connection. Depending on the type of CPU, one or two further PROFIBUS DP interfaces are possible directly on the CPU using additive IF 964 DP interface modules. If required, up to 10 PROFIBUS communications modules can be additionally operated on each CPU.

S7-400 automation systems can be integrated via a PROFINET interface into the CPU in PROFINET IO, some types via communications module CP 443-1 as well.

¹⁾ An additional hardware upgrade package (HUP CPU 410-5H) is required for SIMATIC PCS 7 V8.0+SP1

More information**Online configurators**

Selected SIMATIC S7-400 components are combined as "AS bundles" according to the task involved for the modular SIMATIC PCS 7 automation systems. Configurators are available in the Industry Mall help you to assemble the AS bundles:

- Online configurators for AS 410 automation systems
 - SIMATIC PCS 7 AS 410 Single Station configurator
 - SIMATIC PCS 7 AS 410 Redundancy Station configurator
- Online configurators for complementary S7-400 systems
 - SIMATIC PCS 7 AS Single Station configurator
 - SIMATIC PCS 7 AS Redundancy Station configurator

SIMATIC PCS 7 system hardware

Automation systems

AS 410-5H and AS 410E modular systems

Overview



AS 410S on CR3 rack

With the rugged all-round AS 410 system, the SIMATIC PCS 7 process control system offers an exclusive automation system from the SIMATIC S7-400 series, which can be used in all domains due to its versatility.

The rugged AS 410 is a modern, future-oriented, all-round system for the process industry. Its versatility means it can be used in all areas – as a standard AS 410S system, as a high-availability AS 410H or as safety-related AS 410F/FH. More and more innovative functions are being exclusively combined with this automation system, for example redundant PROFINET configurations and configuration changes during operation for PROFINET in singular and redundant applications

With its high-performance hardware and optimized firmware, the innovative **CPU 410-5H Process Automation** of the AS 410 covers the entire performance range of conventional AS 412 to AS 417 automation systems. Its automation performance can be scaled with System Expansion Cards based on the number of SIMATIC PCS 7 process objects (POs) as follows:

- 100 POs
- 500 POs
- 1 000 POs
- 1 600 POs
- $\geq 2\,000$ POs (PO 2k+)

The type reduction to a single CPU offers numerous advantages. It significantly simplifies selection and configuration of the automation system as well as spare part inventory and plant expansion.

The AS 410E automation systems with **CPU 410E Process Automation** is a cost-saving alternative for applications with a few process objects. Based on CPU 410-5H hardware, it offers the same benefits for applications with up to 200 PO.

Design

Like all SIMATIC PCS 7 automation systems of the S7-400 series, AS 410 automation systems are available as "AS bundles" as follows:

- Individual components bundled per system in one delivery
- Pre-assembled and tested complete systems (no extra charge compared to delivery of individual components)

The AS bundles come furnished with the SIMATIC PCS 7 Runtime license for 100 process objects (PO). Building on this, the number of process objects can be increased with cumulative AS Runtime licenses for 100, 1 000 or 10 000 POs.

The configuration of the AS bundles as well as the Article No.'s can be defined by selecting pre-configured ordering units. System-specific ordering configurations are available in tabular form for this purpose in the sections "Standard automation systems", "Fault-tolerant automation systems" and "Safety-related automation systems".

For interactive configuration of AS bundles, there are also two online configurators available in the Industry Mall:

- SIMATIC PCS 7 AS 410 Single Station configurator
- SIMATIC PCS 7 AS 410 Redundancy Station configurator

CPU, aluminum rack (except UR1), optional redundancy or redundant power supply modules (in 4 A and 10 A versions), communications modules and sync modules of the SIMATIC PCS 7 AS 410 bundles have an additional coating (conformal coating).

AS 410 bundles for operating temperatures up to 70 °C

The AS 410 bundles are usually designed for operating temperatures up to 60 °C. Additional designs are available for extreme conditions; these are permitted for operating temperatures up to 70 °C. Their components mainly carry the designation "XTR" (extended temperature range) in their names. All components of the "AS 410 bundles for the extended temperature range (XTR)" also have an additional coating (conformal coating).

The Article No.'s of the AS 410 bundles for the extended temperature range (XTR) can be defined in the sections "Standard automation systems", "High availability automation systems" and "Safety-related automation systems" by means of an individual configuration table.

Design (continued)

Flexible and scalable availability

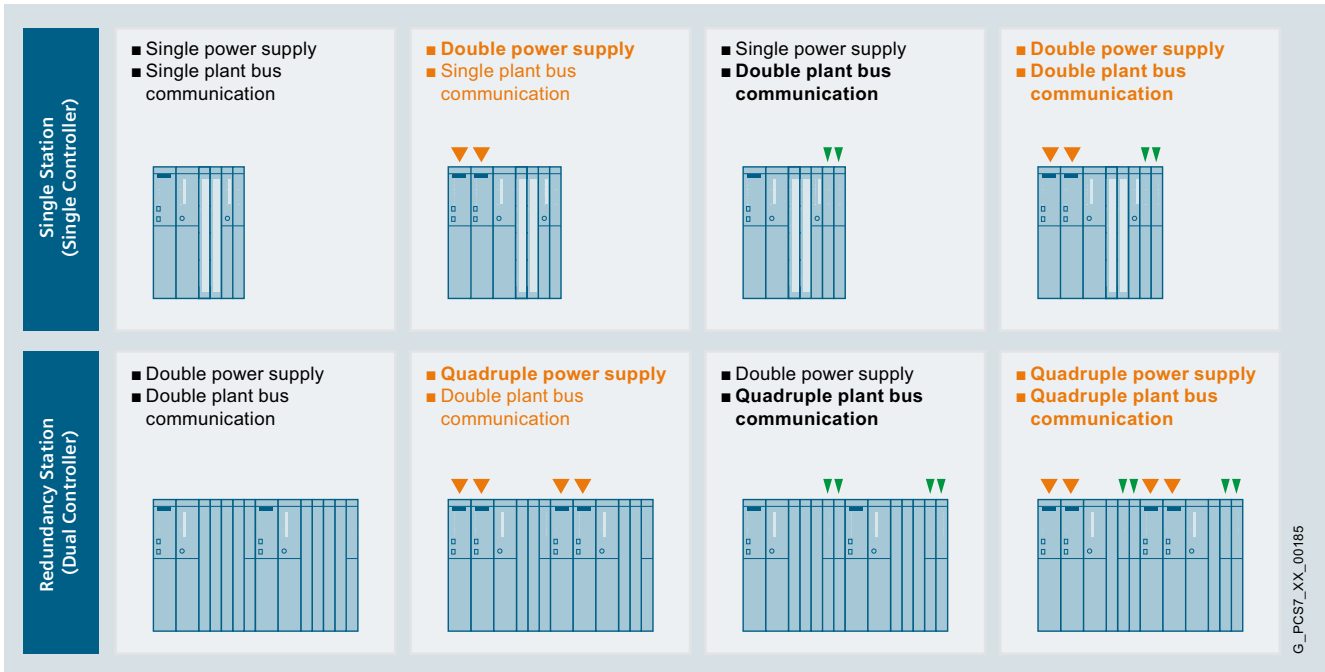

A particular characteristic of the modular S7-400 systems is the flexible and scalable availability of various components.

For a SIMATIC PCS 7 AS Single Station of the AS 410 type, you have the option of specifically increasing the availability by implementing a redundant configuration of the power supply or the Industrial Ethernet communications module, and combining these measures.

Even the AS Redundancy Station of the AS 410 type with its redundant CPUs offers significantly higher availability. It operates according to the 1oo2 principle, in which a switch is made from the active subsystem to the standby system in the event of a fault. Starting from here, you can double the power supply or the Industrial Ethernet communications module for each subsystem, and combine these measures.

SIMATIC PCS 7 system hardware

Automation systems

AS 410-5H and AS 410E modular systems

Design (continued)

CPU 410-5H Process Automation: the "all-rounder" for process automation

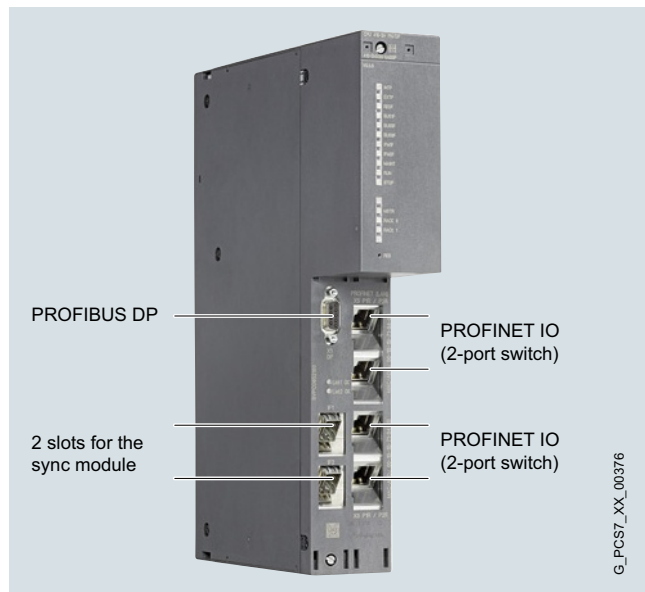

CPU 410-5H Process Automation

The CPU 410-5H Process Automation is at the heart of the standard automation systems as well as the high-availability and safety-related AS 410 automation systems. With Expansion Cards for 100 PO, 500 PO, 1 000 PO, 1 600 PO and PO 2k+ (corresponds to $\geq 2\,600$ PO), you can define your performance for your specific application with up to around 2 600 PO.

If the performance limit defined by the System Expansion Card is reached during configuration, commissioning or operation, a subsequent increase in performance is possible without replacing the hardware by using an appropriate number of CPU 410 Expansion Packs 100 POs/500 POs.

As shown in the figure, CPU 410-5H Process Automation is equipped with two PROFINET IO interfaces (2-port switch in each case) for up to 250 I/O devices and a PROFIBUS DP interface for up to 96 PROFIBUS DP slaves. Two integrated slots allow the synchronization of two redundant subsystems via sync modules and sync cables (FOC).

CPU 410-5H Process Automation supports NTP as well as S7 time synchronization.

Other features include:

- Integrated 48 MB load memory and 32 MB work memory each for program and data
- Cycle time up to 10 ms/9 process tasks
- Total number of I/Os (on PROFIBUS DP and PROFINET IO) approx. 7 500, 16 KB each for inputs and outputs
- Additional protection of the circuit board with coating (conformal coating)
- Expanded temperature range during operation up to 70 °C (as of product version 2)
- High-precision time stamping
- Recessed RESET button
- Preset hardware parameters (PCS 7 skinning)
- Changes in the type of module during operation (TCiR) in association with the SIMATIC PCS 7 Engineering System V8.1 and higher



CPU 410E for small applications

The cost-effective CPU 410E is available for applications with a few process objects, for which it offers the same benefits as the CPU 410-5H in terms of

- Flexibility
 - Standard, high-availability and fail-safe applications
 - Identical hardware as with CPU 410-5H
- Ruggedness
 - Conformal coating
 - Extended temperature range up to 70 °C
- Secure investment
 - 1 PROFIBUS and 2 PROFINET interfaces
 - Innovations in firmware updates

Restrictions compared to CPU 410-5H relate to the number of POs, work memory and I/O data. The following table shows the main differences between and features common to the two CPUs.

	CPU 410E	CPU 410-5H
Work memory (for program and data)	4 MB	32 MB
Load memory (integrated, non-volatile)	48 MB	48 MB
CPU processing times for bit operations, typ.	7.5 ns	7.5 ns
I/O data	1536 bytes inputs/outputs	16 KB inputs/outputs
Number of process objects	Up to 200	100 to 2 k+

Design (continued)

I/O connection via PROFIBUS DP

The distributed process I/O can be integrated into a PROFIBUS DP segment either directly or via a lower-level fieldbus (PROFIBUS PA or FOUNDATION Fieldbus H1). For details, see the "Industrial Communication" chapter, "PROFIBUS DP", "PROFIBUS PA" and "FOUNDATION Fieldbus H1" sections.

PROFIBUS DP segments with distributed process I/O can be operated on a PROFIBUS DP interface in the CPU and on additive CP 443-5 Extended (conformal coating) PROFIBUS DP interface modules. You can configure up to 4 individual or redundant CP 443-5 Extended PROFIBUS DP interface modules (conformal coating) for an automation system using the configurators for SIMATIC PCS 7 automation systems in the Industry Mall as well as in the catalog sections "Standard automation systems", "Fault-tolerant automation systems" and "Safety-related automation systems".

You can additionally implement further PROFIBUS interfaces using separately ordered CP 443-5 Extended PROFIBUS DP interface modules (conformal coating). According to the manual, up to 10 CP 443-5 Extended modules can be operated in one automation system.

I/O connection via PROFINET IO

It is easy to efficiently connect AS 410 automation systems to remote I/O stations via the PROFINET IO interfaces integrated in the CPU 410-5H Process Automation, for example to remote ET 200M or ET 200SP HA I/O stations (see also "Industrial Communication" chapter, "PROFINET" section). PROFINET IO interfaces made available by additive communications modules of type CP 443-1 cannot be used.

Technical specifications

Article number	6ES7410-5HX08-0AB0	6ES7410-5HM08-0AB0
	PCS 7 CPU410-5H F. S7-400/S7-400H/F/FH	PCS 7 CPU 410E F. S7-400/S7-400H/F/FH
General information		
Product type designation	CPU 410-5H	CPU 410E
Design of PLC basic unit	With Conformal Coating (ISA-S71.04 severity level G1; G2; G3) and operating temperature to 70 °C	With Conformal Coating (ISA-S71.04 severity level G1; G2; G3) and operating temperature to 70 °C
Product function		
• SysLog	Yes; via TCP; up to 4 receivers can be parameterized; buffer capacity max. 3 200 entries	Yes; via TCP; up to 4 receivers can be parameterized; buffer capacity max. 3 200 entries
• Field interface security	Yes	Yes
Engineering with		
• Programming package	SIMATIC PCS 7 V9.0 or higher	SIMATIC PCS 7 V9.0 or higher
Processor		
CPU speed	450 MHz; Multi-processor system	450 MHz; Multi-processor system
Memory		
PCS 7 process objects	100 ... approx. 2 600, adjustable with System Expansion Card	200; max.
Work memory		
• integrated	32 Mbyte; max., dependent on the System Expansion Card used	4 Mbyte
• integrated (for program)	Dependent on the System Expansion Card used	4 Mbyte; max.
• integrated (for data)	Dependent on the System Expansion Card used	4 Mbyte; max.
• expandable	Dependent on the System Expansion Card used	No
CPU processing times		
average processing time of PCS 7 typicals	110 µs; with APL Typicals	110 µs; with APL Typicals
Process tasks, max.	9; Individually adjustable from 10 ms to 5 s	9; Individually adjustable from 10 ms to 5 s
IEC counter		
• present	Yes	Yes
IEC timer		
• present	Yes	Yes
Data areas and their retentivity		
Flag		
• Size, max.	16 384 byte	16 384 byte

SIMATIC PCS 7 system hardware

Automation systems

AS 410-5H and AS 410E modular systems

Technical specifications (continued)

Article number	6ES7410-5HX08-0AB0	6ES7410-5HM08-0AB0
	PCS 7 CPU410-5H F. S7-400/S7-400H/F/FH	PCS 7 CPU 410E F. S7-400/S7-400H/F/FH
Address area		
I/O address area		
• Inputs	16 kbyte; max., dependent on the System Expansion Card used	2 048 byte; max. 1 536 bytes for inputs or outputs per interface
• Outputs	16 kbyte; max., dependent on the System Expansion Card used	2 048 byte; max. 1 536 bytes for inputs or outputs per interface
Time of day		
Clock		
• Hardware clock (real-time)	Yes	Yes
Operating hours counter		
• Number	16	16
Interfaces		
Number of PROFINET interfaces	2	2
Number of RS 485 interfaces	1; PROFIBUS DP	1; PROFIBUS DP
Number of other interfaces	2; 2x synchronization	2; 2x synchronization
1. Interface		
Interface type	RS 485 / PROFIBUS	RS 485 / PROFIBUS
Protocols		
• PROFIBUS DP master	Yes	Yes
• PROFIBUS DP slave	No	No
PROFIBUS DP master		
• Number of DP slaves, max.	96	96
• Number of slots per interface, max.	1 632	1 632
2. Interface		
Protocols		
• PROFINET IO Controller	Yes	Yes
• PROFINET IO Device	No	No
• PROFINET CBA	No	No
PROFINET IO Controller		
Services		
- Number of connectable IO Devices, max.	250	250
- Number of connectable IO Devices for RT, max.	250	250
3. Interface		
Protocols		
• PROFINET IO Controller	Yes	Yes
• PROFINET IO Device	No	No
• PROFINET CBA	No	No
PROFINET IO Controller		
Services		
- Number of connectable IO Devices, max.	250	250
- Number of connectable IO Devices for RT, max.	250	250
4. Interface		
Interface type	Pluggable synchronization submodule (FO)	Pluggable synchronization submodule (FO)
Plug-in interface modules	Synchronization module 6ES7960-1AA06-0XA0, 6ES7960-1AB06-0XA0 or 6ES7960-1AA08-0XA0	Synchronization module 6ES7960-1AA06-0XA0, 6ES7960-1AB06-0XA0 or 6ES7960-1AA08-0XA0
5. Interface		
Interface type	Pluggable synchronization submodule (FO)	Pluggable synchronization submodule (FO)
Plug-in interface modules	Synchronization module 6ES7960-1AA06-0XA0, 6ES7960-1AB06-0XA0 or 6ES7960-1AA08-0XA0	Synchronization module 6ES7960-1AA06-0XA0, 6ES7960-1AB06-0XA0 or 6ES7960-1AA08-0XA0

Technical specifications (continued)

Article number	6ES7410-5HX08-0AB0	6ES7410-5HM08-0AB0
	PCS 7 CPU410-5H F. S7-400/S7-400H/F/FH	PCS 7 CPU 410E F. S7-400/S7-400H/F/FH
Protocols		
Supports protocol for PROFINET IO	Yes	Yes
PROFINET CBA	No	No
PROFIsafe	Yes	Yes
PROFIBUS	Yes	Yes
AS-Interface	Yes; Via add-on	Yes; Via add-on
SIMATIC communication		
• S7 routing	Yes	Yes
Further protocols		
• Foundation Fieldbus	Yes; via DP/FF Link	Yes; via DP/FF Link
• MODBUS	Yes; Via add-on	Yes; Via add-on
Communication functions		
PG/OP communication	Yes	Yes
Data record routing	Yes	Yes
S7 communication		
• supported	Yes	Yes
Number of connections		
• overall	120	120
Ambient conditions		
Ambient temperature during operation		
• min.	0 °C	0 °C
• max.	70 °C	70 °C
Configuration		
Know-how protection		
• User program protection/password protection	Yes	Yes
• Block encryption	Yes; With S7 block Privacy	Yes; With S7 block Privacy
Dimensions		
Width	50 mm	50 mm
Height	290 mm	290 mm
Depth	219 mm	219 mm
Weights		
Weight, approx.	1.1 kg	1.1 kg

Accessories
Backup batteries

Lithium backup batteries of type AA with 2.3 Ah are used in the power supply modules of all SIMATIC PCS 7 automation systems of the S7-400 range (AS bundles). Since lithium batteries are easily inflammable, more rigorous transport and storage regulations apply to them.

To avoid subjecting the AS bundles to these more rigorous transport and storage regulations, the backup batteries must be ordered and delivered separately (Article No. 6ES7971-0BA00 or 6ES7971-0BA02).

The following backup batteries are required depending on the configuration of the AS bundles:

- SIMATIC PCS 7 AS Single Station with
 - 1 power supply module: 2 units
 - 2 redundant power supply modules: 4 units
- SIMATIC PCS 7 AS Redundancy Station with
 - 2 power supply modules: 4 units
 - 2 x 2 redundant power supply modules: 8 units

SIMATIC PCS 7 system hardware

Automation systems

AS 410-5H and AS 410E modular systems

Standard automation systems

Overview



Standard AS 410S automation system

The AS 410S modular standard automation systems are suitable for general use. These are always your first choice if high availability through redundancy and safety-related functions are not relevant for the application.

In the range from 100 to approx. 2 600 POs, their performance can be customized to meet the task at hand using System Expansion Cards.

An AS 410S is also the base system for a fault-tolerant (AS 410H) or a safety-related automation system (AS 410F, AS 410FH). Your decision for the AS 410S is therefore not final, you can remain flexible. If the task changes, the automation system can be used differently at any time and the target system can be expanded accordingly.

Design

Individual configuration of AS bundles

The configuration of the standard automation systems as well as the Article No.'s can be defined by selecting pre-configured ordering units.

Typical combinations can be selected from the tables in the "Ordering data" section of the printed catalog. The complete range is available to you via the SIMATIC PCS 7 AS 410 Single Station online configurator in the Industry Mall.

Subsequent increase in performance

If the performance limit defined by the ordered system expansion card is reached during configuration, commissioning or operation, a subsequent increase in performance is possible by using an appropriate number of CPU 410 Expansion Packs 100 POs/500 POs. Hardware modifications are not necessary.

I/O connection via PROFIBUS DP

Several PROFIBUS DP segments with distributed process I/Os can be operated on one standard automation system. A PROFIBUS DP interface is already integrated in the CPU 410-5H Process Automation. Up to four additional PROFIBUS DP interfaces can be configured using additive PROFIBUS DP interface modules CP 443-5.

I/O connection via PROFINET IO

Standard AS 410S automation systems can only be connected to remote I/O stations via the two PROFINET interfaces (each with 2-port switch) integrated in the CPU 410-5H Process Automation, for example to remote ET 200M/ET 200SP HA I/O stations (see also "Industrial Communication" chapter, "PROFINET" section).

The availability of the I/O devices can be increased by a ring topology with media redundancy (MRP). If the transmission link in the ring is interrupted at a given location, for example, due to a break in the ring cable or the failure of a station, the redundancy manager, e.g. the CPU, immediately activates the alternative communication path.

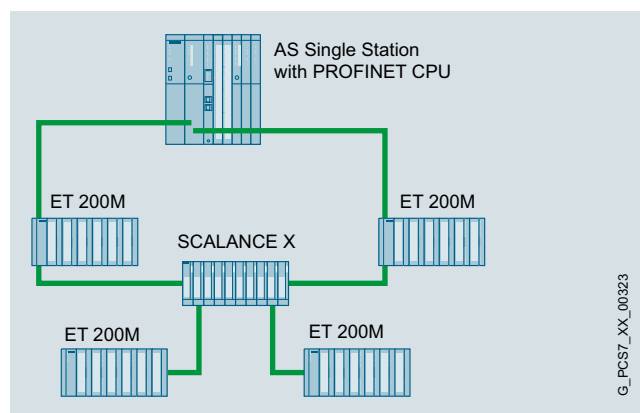

Example for PROFINET IO communication with media redundancy

Industrial Ethernet (IE) plant bus communication

If the PROFINET interfaces integrated in the CPU are not used for PROFINET IO, they can then also be used for the connection to the Industrial Ethernet plant bus. Otherwise, the AS 410S standard automation system can be connected to the Industrial Ethernet plant bus via the CP 443-1 communication module (conformal coating). If necessary, the availability of plant bus communication can be increased by using a second CP 443-1 communication module (conformal coating).

Redundant power supply

If you have two separate power supply networks for your plant, you can increase the availability of the AS 410S standard automation systems by using two redundant power supplies.

Runtime licenses

The AS bundles come furnished with the SIMATIC PCS 7 Runtime license for 100 POs. The number of process objects can be extended by additional Runtime licenses for 100, 1000 or 10 000 POs. The process objects of additional Runtime licenses can be added to process objects which already exist. The number and type (e.g. 100 or 1000) of additional Runtime licenses is irrelevant with regard to the implementable quantity framework.

Ordering data

Standard automation systems with CPU 410-5H

	Article No.					
AS 410S CPU 410-5H with PROFIBUS DP and PROFINET IO interface 32 MB work memory (16 MB each for program and data) with SIMATIC PCS 7 AS Runtime license for 100 POs	6ES7654-					
	C	0	-	F		
Type of delivery						
• Individual components, not pre-assembled	5					
• Pre-assembled and tested	6					
System Expansion Card						
• System Expansion Card 100 POs		J				
• System Expansion Card 500 POs		L				
• System Expansion Card 1 000 POs		N				
• System Expansion Card 1 600 POs		P				
• System Expansion Card PO 2k+ (≥ 2 000)		Q				
• System Expansion Card 0 PO (blank)		R				
Additive Industrial Ethernet interface modules¹⁾						
• Without CP 443-1		0				
• 1 × CP 443-1 ²⁾		3				
• 2 × CP 443-1 ²⁾		4				
Racks						
• UR2 (9 slots), aluminum ¹⁾²⁾				3		
• UR2 (9 slots), steel ¹⁾				4		
• UR1 (18 slots), aluminum				5		
• UR1 (18 slots), steel				6		
• CR3 (4 slots), aluminum ²⁾³⁾				7		
Power supply (without backup batteries)						
• 1 × PS 407, 4 A for 120/230 V UC ²⁾⁴⁾				A		
• 1 × PS 407, 10 A for 120/230 V UC				B		
• 1 × PS 407, 10 A for 120/230 V UC, optional redundancy ²⁾				C		
• 1 × PS 407, 20 A for 120/230 V UC				D		
• 2 × PS 407, 10 A for 120/230 V UC, redundant ²⁾				E		
• 1 × PS 405, 4 A for 24 V DC ²⁾⁴⁾				F		
• 1 × PS 405, 10 A for 24 V DC				G		
• 1 × PS 405, 10 A for 24 V DC, optional redundancy ²⁾				H		
• 1 × PS 405, 20 A for 24 V DC				J		
• 2 × PS 405, 10 A for 24 V DC, redundant ²⁾				K		
Additive PROFIBUS DP interface modules¹⁾						
• Without CP 443-5 Extended						0
• 1 × CP 443-5 Extended ²⁾						1
• 2 × CP 443-5 Extended ²⁾						2
• 3 × CP 443-5 Extended ²⁾						3
• 4 × CP 443-5 Extended ²⁾						4

¹⁾ Up to 5 CPs (Industrial Ethernet/PROFIBUS) can be plugged into the UR2 rack with a single power supply, or up to 3 CPs with a redundant power supply.

²⁾ Conformal coating

³⁾ Only in conjunction with 4 A power supplies

⁴⁾ Only in conjunction with CR3 rack

Standard automation systems with CPU 410-5H for the expanded temperature range (XTR)

	Article No.					
AS 410S CPU 410-5H with PROFIBUS DP and PROFINET IO interface 32 MB work memory (16 MB each for program and data) with SIMATIC PCS 7 AS Runtime license for 100 POs	6ES7654-					
	C	0	-	F		
Type of delivery						
• Individual components, not pre-assembled	5					
• Pre-assembled and tested	6					
System Expansion Card						
• System Expansion Card 100 POs		J				
• System Expansion Card 500 POs		L				
• System Expansion Card 1 000 POs		N				
• System Expansion Card 1 600 POs		P				
• System Expansion Card PO 2k+ (≥ 2 000)		Q				
• System Expansion Card 0 PO (blank)		R				
Additive Industrial Ethernet interface modules						
• Without CP 443-1				0		
• 1 × CP 443-1				3		
• 2 × CP 443-1				4		
Racks						
• UR2 XTR (9 slots), aluminum ¹⁾					3	
• CR3 XTR, 4 slots, aluminum ²⁾					7	
Power supply (without backup batteries)						
• 1 × PS 407, 4 A XTR for 120/230 V UC ³⁾						A
• 1 × PS 407, 10 A XTR for 120/230 V UC, optional redundancy						C
• 2 × PS 407, 10 A XTR for 120/230 V UC, redundant						E
• 1 × PS 405, 4 A XTR for 24 V DC ³⁾						F
• 1 × PS 405, 10 A XTR for 24 V DC, optional redundancy						H
• 2 × PS 405, 10 A XTR for 24 V DC, redundant						K
Additive PROFIBUS DP interface modules						
• Without CP 443-5 Extended						0

¹⁾ Only in conjunction with 10 A power supplies

²⁾ Only in conjunction with 4 A power supplies

³⁾ Only in conjunction with CR3 rack

SIMATIC PCS 7 system hardware

Automation systems

AS 410-5H and AS 410E modular systems

Standard automation systems

Ordering data (continued)

Standard automation systems with CPU 410E

	Article No.						
AS 410SE CPU 410E with PROFIBUS DP and PROFINET IO interface 4 MB work memory (2 MB each for program and data) with SIMATIC PCS 7 AS Runtime license for 100 POs and System Expansion Card PO 200M	6ES7654-						
	E	K	O	-		F	
Type of delivery							
• Individual components, not pre-assembled	5						
• Pre-assembled and tested	6						
Additive Industrial Ethernet interface modules¹⁾							
• Without CP 443-1	0						
• 1 × CP 443-1 ²⁾	3						
• 2 × CP 443-1 ²⁾	4						
Racks							
• UR2 (9 slots), aluminum ¹⁾²⁾	3						
• UR2 (9 slots), steel ¹⁾	4						
• CR3 (4 slots), aluminum ²⁾³⁾	7						
Power supply (without backup batteries)							
• 1 × PS 407, 4 A for 120/230 V UC ²⁾⁴⁾	A						
• 1 × PS 407, 10 A for 120/230 V UC	B						
• 1 × PS 407, 10 A for 120/230 V UC, optional redundancy ²⁾	C						
• 2 × PS 407, 10 A for 120/230 V UC, redundant ²⁾	E						
• 1 × PS 405, 4 A for 24 V DC ²⁾⁴⁾	F						
• 1 × PS 405, 10 A for 24 V DC	G						
• 1 × PS 405, 10 A for 24 V DC, optional redundancy ²⁾	H						
• 2 × PS 405, 10 A for 24 V DC, redundant ²⁾	K						
Additive PROFIBUS DP interface modules¹⁾							
• Without CP 443-5 Extended	0						
• 1 × CP 443-5 Extended ²⁾	1						
• 2 × CP 443-5 Extended ²⁾	2						
• 3 × CP 443-5 Extended ²⁾	3						
• 4 × CP 443-5 Extended ²⁾	4						

¹⁾ Up to 5 CPs (Industrial Ethernet/PROFIBUS) can be plugged into the UR2 rack with a single power supply, or up to 3 CPs with a redundant power supply.

²⁾ Conformal coating

³⁾ Only in conjunction with 4 A power supplies

⁴⁾ Only in conjunction with CR3 rack

Individual components

Individual components for AS 410S standard automation systems	
CPU 410-5H Process Automation as spare part Conformal coating; for operating temperature up to 70 °C 32 MB work memory integrated (16 MB each for program and data); module occupies 2 slots	6ES7410-5HX08-0AB0
CPU 410-5H Process Automation 100 PO Bundle CPU bundle, consisting of CPU 410-5H Process Automation and PCS 7 System Expansion Card for 100 PO	6ES7654-5CJ00-0XF0

Standard automation systems with CPU 410E for the expanded temperature range (XTR)

	Article No.						
AS 410SE CPU 410E with PROFIBUS DP and PROFINET IO interface 4 MB work memory (2 MB each for program and data) with SIMATIC PCS 7 AS Runtime license for 100 POs and System Expansion Card PO 200M	6ES7654-						
	E	K	O	-		F	
Type of delivery							
• Individual components, not pre-assembled	5						
• Pre-assembled and tested	6						
Additive Industrial Ethernet interface modules							
• Without CP 443-1	0						
• 1 × CP 443-1	3						
• 2 × CP 443-1	4						
Racks							
• UR2 XTR (9 slots), aluminum ¹⁾	3						
• CR3 XTR, 4 slots, aluminum ²⁾	7						
Power supply (without backup batteries)							
• 1 × PS 407, 4 A XTR for 120/230 V UC ³⁾	A						
• 1 × PS 407, 10 A XTR for 120/230 V UC, optional redundancy	C						
• 2 × PS 407, 10 A XTR for 120/230 V UC, redundant	E						
• 1 × PS 405, 4 A XTR for 24 V DC ³⁾	F						
• 1 × PS 405, 10 A XTR for 24 V DC, optional redundancy	H						
• 2 × PS 405, 10 A XTR for 24 V DC, redundant	K						
Additive PROFIBUS DP interface modules							
• Without CP 443-5 Extended	0						

¹⁾ Only in conjunction with 10 A power supplies

²⁾ Only in conjunction with 4 A power supplies

³⁾ Only in conjunction with CR3 rack

CPU 410-5H Process Automation 500 PO Bundle CPU bundle, consisting of CPU 410-5H Process Automation and PCS 7 System Expansion Card for 500 PO	6ES7654-5CL00-0XF0
CPU 410-5H Process Automation 1 000 PO Bundle CPU bundle, consisting of CPU 410-5H Process Automation and PCS 7 System Expansion Card for 1 000 PO	6ES7654-5CN00-0XF0
CPU 410-5H Process Automation 1 600 PO Bundle CPU bundle, consisting of CPU 410-5H Process Automation and PCS 7 System Expansion Card for 1 600 PO	6ES7654-5CP00-0XF0

SIMATIC PCS 7 system hardware

Automation systems

AS 410-5H and AS 410E modular systems

Standard automation systems

Ordering data	Article No.	Article No.	
CPU 410-5H Process Automation PO 2k+ Bundle CPU bundle, consisting of CPU 410-5H Process Automation and PCS 7 System Expansion Card for PO 2k+ (≥ 2 000)	6ES7654-5CQ00-0XF0	Backup battery For PS 405/407, type AA, 3.6 V, 2.3 Ah	6ES7971-0BA00
CPU 410 Expansion Pack For subsequent increase in performance of the CPU 410-5H process automation Upgrade option for 1 installation, independent of language Without SIMATIC PCS 7 Software Media Package <ul style="list-style-type: none"> Goods delivery License key on USB flash drive, Certificate of License - 100 POs - 500 POs Online delivery License key download, online Certificate of License Note: Email address required! - 100 POs - 500 POs 	6ES7653-2CA00-0XE0 6ES7653-2CC00-0XE0 6ES7653-2CA00-0XK0 6ES7653-2CC00-0XK0	XTR backup battery For PS 405/407, type AA, 3.6 V, 2.3 Ah; for operating temperatures up to 70 °C	6ES7971-0BA02
		Aluminum rack <ul style="list-style-type: none"> UR1, 18 slots UR2 XTR, 9 slots (conformal coating; for operating temperature up to 70 °C) CR3 XTR, 4 slots (conformal coating; for operating temperature up to 70 °C) 	6ES7400-1TA11-0AA0 6ES7400-1JA11-0AA1 6ES7401-1DA01-0AA1
		Steel rack <ul style="list-style-type: none"> UR1, 18 slots UR2, 9 slots 	6ES7400-1TA01-0AA0 6ES7400-1JA01-0AA0
		Individual components for AS 410E standard automation systems	
PS 407 power supply module with battery compartment for 2 backup batteries, module occupies 2 slots <ul style="list-style-type: none"> 4 A XTR (conformal coating; for operating temperature up to 70 °C) 120/230 V UC; 5 V DC/4 A, 24 V DC/0.5 A 10 A 120/230 V UC; 5 V DC/10 A, 24 V DC/1 A 10 A XTR, optional redundancy (conformal coating; for operating temperature up to 70 °C) 120/230 V UC; 5 V DC/10 A, 24 V DC/1 A 20 A 120/230 V UC; 5 V DC/20 A, 24 V DC/1 A 	6ES7407-0DA02-0AA1 6ES7407-0KA02-0AA0 6ES7407-0KR02-0AA1 6ES7407-0RA02-0AA0	CPU 410E Process Automation as spare part Conformal coating; for operating temperature up to 70 °C 4 MB work memory integrated (2 MB each for program and data); module occupies 2 slots	6ES7410-5HM08-0AB0
		Runtime licenses for SIMATIC PCS 7 automation systems (can be added to existing licenses)	
PS 405 power supply module with battery compartment for 2 backup batteries, module occupies 2 slots <ul style="list-style-type: none"> 4 A XTR (conformal coating; for operating temperature up to 70 °C) 24/48/60 V DC; 5 V DC/4 A, 24 V DC/0.5 A 10 A 24/48/60 V DC; 5 V DC/10 A, 24 V DC/1 A 10 A XTR, optional redundancy (conformal coating; for operating temperature up to 70 °C) 24/48/60 V DC; 5 V DC/10 A, 24 V DC/1 A 20 A 24/48/60 V DC; 5 V DC/20 A, 24 V DC/1 A; with battery compartment for 2 backup batteries, module occupies 2 slots 	6ES7405-0DA02-0AA1 6ES7405-0KA02-0AA0 6ES7405-0KR02-0AA1 6ES7405-0RA02-0AA0	SIMATIC PCS 7 AS Runtime license Language-neutral, floating license for 1 user Without SIMATIC PCS 7 Software Media Package <ul style="list-style-type: none"> Goods delivery License key on USB flash drive, Certificate of License - 100 POs - 1 000 POs - 10 000 POs Online delivery License key download, online Certificate of License Note: Email address required! - 100 POs - 1 000 POs - 10 000 POs 	6ES7653-2BA00-0XB5 6ES7653-2BB00-0XB5 6ES7653-2BC00-0XB5 6ES7653-2BA00-0XH5 6ES7653-2BB00-0XH5 6ES7653-2BC00-0XH5

SIMATIC PCS 7 system hardware

Automation systems

AS 410-5H and AS 410E modular systems

High-availability automation systems

Overview



Redundancy Station AS 410H

High availability automation systems are used to reduce the risk of production failures. The higher investment costs for high availability automation systems are frequently negligible compared to the costs resulting from production failures. The higher the costs of a production failure, the more worthwhile it is to use a high availability system.

High availability SIMATIC PCS 7 automation systems can be used in a system configuration on their own or together with standard and safety-related automation systems.

Design

The AS 410H, which consists of two redundant, galvanically isolated subsystems, can be mounted on a UR2-H compact rack with a split backplane bus or on two separate racks (UR1 or UR2). The configuration in two racks has the advantage that the redundant subsystems are spatially separated (for example, by a fire-proof wall) and can be located far apart from each other. Depending on the sync modules used, distances from 10 m to 10 km are possible between the two subsystems. As a result of the electrical isolation, the system is also resistant to EMC interference.

Individual configuration of AS bundles

The configuration of the high availability automation systems and the Article No.'s can be defined by selecting pre-configured ordering units.

Typical combinations can be selected from the tables in section "Ordering data" of the paper catalog. The complete range for selection is available via the SIMATIC PCS 7 AS 410 Redundancy Station online configurator in the Industry Mall.

Ordering information:

- For an AS 410H redundant configuration based on two AS Single Stations (AS 410S), you also require 4 sync modules (up to 10 m or up to 10 km) and 2 fiber-optic sync cables. The selection depends on the distance between the two AS single stations.
- FO sync cables longer than 1 m must always be ordered separately (2 cables required in each case).

Subsequent increase in performance/ use of redundant PROFINET (R1)

If the performance limit defined by the ordered system expansion card is reached during configuration, commissioning or operation, a subsequent increase in performance is possible by using an appropriate number of CPU 410 Expansion Packs 100 POs/500 POs. Hardware modifications are not necessary.

Aside from increasing performance, the redundancy functions of PROFINET can also be expanded. If a redundant PROFINET (R1) is to be used in place of PROFINET system redundancy (S2), this function can be expanded with the "CPU 410 Expansion Pack PN Red".

Design (continued)**I/O connection via PROFIBUS DP**

The distributed process I/O can be integrated into a PROFIBUS DP segment either directly or via a lower-level fieldbus (PROFIBUS PA or FOUNDATION Fieldbus H1).

Several PROFIBUS DP segments with distributed process I/Os can be operated on an AS 410H high availability automation system. A PROFIBUS DP interface is integrated in each of the two CPUs 410-5H Process Automation. Up to four more PROFIBUS DP interfaces with add-on CP 443-5 PROFIBUS DP interfaces (conformal coating) can be configured for each redundant subsystem.

With redundant PROFIBUS DP lines, the process I/Os can be connected to an AS 410H as follows:

- ET 200M remote I/Os stations with two IM 153-2 High Feature interface modules on a special bus module
- ET 200iSP remote I/Os stations with two IM 152-1 on a special terminal module
- Field devices on the PROFIBUS PA over a PA link to two redundant IM 153-2 High Feature interface modules
- Field devices on the FOUNDATION Fieldbus H1 via a redundant Compact FF Link pair
- Non-redundant PROFIBUS DP devices, e.g. ET 200S or ET 200pro remote I/O stations per Y-Link

I/O connection via PROFINET IO

High availability AS 410H automation systems can be connected via PROFINET IO with remote I/O stations, for example, ET 200M or ET 200SP remote I/O stations. Only the PROFINET interfaces integrated in the CPUs can be used for this on the automation system.

The maximum availability with minimum error reaction times is achieved by the AS 410H when used in conjunction with system redundancy of the I/O devices. System redundancy refers to a type of PROFINET IO communication in which each I/O device establishes a communication link to each of the two CPUs of an AS 410H over the topological network. Then, the failure of a CPU does not automatically lead to failure of the connected I/O devices.

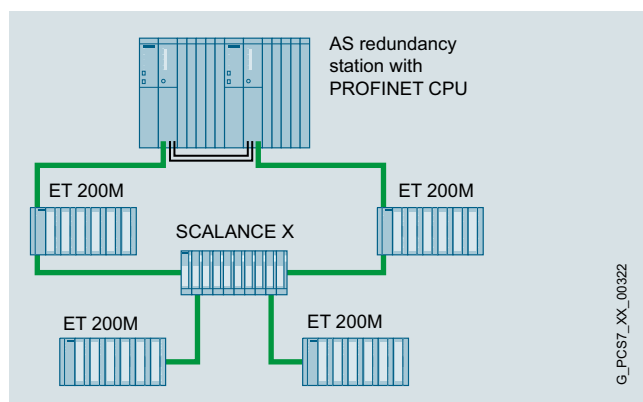

PROFINET IO communication with system redundancy

Communication via the Industrial Ethernet (IE) plant bus

If the PROFINET interfaces integrated in the CPUs of the AS 410H are not used for PROFINET IO, they can then also be used for the connection to the Industrial Ethernet plant bus. Otherwise, the two subsystems of the AS 410H can be connected to the plant bus using one CP 443-1 communication module (conformal coating) each.

The plant bus can be implemented in the form of a ring structure, which can also be configured with redundant architecture if the availability requirements are high. When there are two redundant rings it makes sense to configure two IE interface/communication modules in each case and to distribute their connections between the two rings (4-way connection). Double faults such as failure of the switch on ring 1 with simultaneous interruption of the bus cable on ring 2 can thus be tolerated.

Runtime licenses

The automation systems come furnished with the SIMATIC PCS 7 AS Runtime license for 100 process objects (PO). The number of process objects can be extended by additional Runtime licenses for 100, 1 000 or 10 000 POs. The process objects of additional Runtime licenses can be added to process objects which already exist. The number and type (e.g. 100 or 1000) of additional Runtime licenses are irrelevant.

SIMATIC PCS 7 system hardware

Automation systems

AS 410-5H and AS 410E modular systems

High-availability automation systems**Ordering data****High-availability automation systems with CPU 410-5H**

	Article No.					
	6ES7656-					
	C			-		F
AS 410H (Redundancy Station) 2 × CPU 410-5H with PROFIBUS DP and PROFINET IO interface 32 MB work memory (16 MB each for program and data) with SIMATIC PCS 7 AS Runtime license for 100 POs						
Type of delivery						
• Individual components, not pre-assembled	5					
• Pre-assembled and tested	6					
System Expansion Card						
• 2 × System Expansion Card 100 PO		J				
• 2 × System Expansion Card 500 PO		L				
• 2 × System Expansion Card 1 000 PO		N				
• 2 × System Expansion Card 1 600 PO		P				
• 2 × System Expansion Card PO 2k+ (≥ 2 000)		Q				
• 2 × System Expansion Card 0 PO (empty)		R				
Sync modules and cables						
• 2 × 2 sync modules ²⁾ for distances up to 10 m and 2 × FO sync cable, 1 m			3			
• 2 × 2 sync modules for up to 10 km and 2 × FO sync cable, 1 m, for testing			4			
Additive Industrial Ethernet interface modules¹⁾						
• Without CP 443-1				0		
• 2 × 1 CP 443-1 ²⁾				3		
• 2 × 2 CP 443-1 ²⁾				4		
Racks						
• 1 × UR2-H (2 × 9 slots), aluminum ¹⁾²⁾					1	
• 1 × UR2-H (2 × 9 slots), steel ¹⁾					2	
• 2 × UR2 (9 slots), aluminum ¹⁾²⁾					3	
• 2 × UR2 (9 slots), steel ¹⁾					4	
• 2 × CR3 (4 slots), aluminum ²⁾³⁾					7	
Power supply (without backup batteries)						
• 2 × PS 407, 4 A for 120/230 V UC ²⁾⁴⁾						A
• 2 × PS 407, 10 A for 120/230 V UC						B
• 2 × PS 407, 10 A for 120/230 V UC, optional redundancy ²⁾						C
• 2 × PS 407, 20 A for 120/230 V UC						D
• 2 × 2 PS 407, 10 A for 120/230 V UC, redundant ²⁾						E
• 2 × PS 405, 4 A for 24 V DC ²⁾⁴⁾						F
• 2 × PS 405, 10 A for 24 V DC						G
• 2 × PS 405, 10 A for 24 V DC, optional redundancy ²⁾						H
• 2 × PS 405, 20 A for 24 V DC						J
• 2 × 2 PS 405, 10 A for 24 V DC, redundant ²⁾						K
Additive PROFIBUS DP interface modules¹⁾						
• Without CP 443-5 Extended						0
• 2 × 1 CP 443-5 Extended ²⁾						1
• 2 × 2 CP 443-5 Extended ²⁾						2
• 2 × 3 CP 443-5 Extended ²⁾						3
• 2 × 4 CP 443-5 Extended ²⁾						4

1) In configurations with UR2/UR2-H racks, up to 5 CPs (Industrial Ethernet/PROFIBUS) can be configured with a single power supply per subsystem, or up to 3 CPs per subsystem with a redundant power supply.

2) Conformal coating

3) Only in conjunction with 4 A power supplies

4) Only in conjunction with CR3 rack

High-availability automation systems with CPU 410-5H for the expanded temperature range (XTR)

	Article No.					
	6ES7656-					
	C			-		F
AS 410H (Redundancy Station) 2 × CPU 410-5H with PROFIBUS DP and PROFINET IO interface 32 MB work memory (16 MB each for program and data) with SIMATIC PCS 7 AS Runtime license for 100 POs						
Type of delivery						
• Individual components, not pre-assembled	5					
• Pre-assembled and tested	6					
System Expansion Card						
• 2 × System Expansion Card 100 PO		J				
• 2 × System Expansion Card 500 PO		L				
• 2 × System Expansion Card 1 000 PO		N				
• 2 × System Expansion Card 1 600 PO		P				
• 2 × System Expansion Card PO 2k+ (≥ 2 000)		Q				
• 2 × System Expansion Card 0 PO (empty)		R				
Sync modules and cables						
• 2 × 2 sync modules V8 XTR for distances up to 10 m and 2 × FO sync cable, 1 m				3		
Additive Industrial Ethernet interface modules						
• Without CP 443-1					0	
• 1 × 2 CP 443-1					3	
• 2 × 2 CP 443-1					4	
Racks						
• 1 × UR2-H XTR (2 × 9 slots), aluminum ¹⁾						1
• 2 × UR2 XTR (9 slots), aluminum ¹⁾						3
• 2 × CR3 XTR, 4 slots, aluminum ²⁾						7
Power supply (without backup batteries)						
• 2 × PS 407, 4 A XTR for 120/230 V UC ³⁾						A
• 2 × PS 407, 10 A XTR for 120/230 V UC, optional redundancy						C
• 2 × 2 PS 407, 10 A XTR for 120/230 V UC, redundant						E
• 2 × PS 405, 4 A XTR for 24 V DC ³⁾						F
• 2 × PS 405, 10 A XTR for 24 V DC, optional redundancy						H
• 2 × 2 PS 405, 10 A XTR for 24 V DC, redundant						K
Additive PROFIBUS DP interface modules						
• Without CP 443-5 Extended						0

1) Only in conjunction with 10 A power supplies

2) Only in conjunction with 4 A power supplies

3) Only in conjunction with CR3 rack

Ordering data (continued)

High-availability automation systems with CPU 410E

	Article No.					
	6ES7656-					
	E	K		-		F
AS 410HE (Redundancy Station) 2 × CPU 410E with PROFIBUS DP and PROFINET IO interface 4 MB work memory (2 MB each for program and data) with SIMATIC PCS 7 AS Runtime license for 100 POs and System Expansion Card PO 200M						
Type of delivery						
• Individual components, not pre-assembled	5					
• Pre-assembled and tested	6					
Sync modules and cables						
• 2 × 2 sync modules ²⁾ for distances up to 10 m and 2 × FO sync cable, 1 m			3			
• 2 × 2 sync modules for up to 10 km and 2 × FO sync cable, 1 m, for testing			4			
Additive Industrial Ethernet interface modules¹⁾						
• Without CP 443-1					0	
• 2 × 1 CP 443-1 ²⁾					3	
• 2 × 2 CP 443-1 ²⁾					4	
Racks						
• 1 × UR2-H (2 × 9 slots), aluminum ¹⁾²⁾						1
• 1 × UR2-H (2 × 9 slots), steel ¹⁾						2
• 2 × UR2 (9 slots), aluminum ¹⁾²⁾						3
• 2 × UR2 (9 slots), steel ¹⁾						4
• 2 × CR3 (4 slots), aluminum ²⁾³⁾						7
Power supply (without backup batteries)						
• 2 × PS 407, 4 A for 120/230 V UC ²⁾⁴⁾						A
• 2 × PS 407, 10 A for 120/230 V UC						B
• 2 × PS 407, 10 A for 120/230 V UC, optional redundancy ²⁾						C
• 2 × 2 PS 407, 10 A for 120/230 V UC, redundant ²⁾						E
• 2 × PS 405, 4 A for 24 V DC ²⁾⁴⁾						F
• 2 × PS 405, 10 A for 24 V DC						G
• 2 × PS 405, 10 A for 24 V DC, optional redundancy ²⁾						H
• 2 × 2 PS 405, 10 A for 24 V DC, redundant ²⁾						K
Additive PROFIBUS DP interface modules¹⁾						
• Without CP 443-5 Extended						0
• 2 × 1 CP 443-5 Extended ²⁾						1
• 2 × 2 CP 443-5 Extended ²⁾						2
• 2 × 3 CP 443-5 Extended ²⁾						3
• 2 × 4 CP 443-5 Extended ²⁾						4

¹⁾ In configurations with UR2/UR2-H racks, up to 5 CPs (Industrial Ethernet/PROFIBUS) can be configured with a single power supply per subsystem, or up to 3 CPs per subsystem with a redundant power supply.

²⁾ Conformal coating

³⁾ Only in conjunction with 4 A power supplies

⁴⁾ Only in conjunction with CR3 rack

High-availability automation systems with CPU 410E for the expanded temperature range (XTR)

	Article No.					
	6ES7656-					
	E	K		-		F
AS 410HE (Redundancy Station) 2 × CPU 410E with PROFIBUS DP and PROFINET IO interface 4 MB work memory (2 MB each for program and data) with SIMATIC PCS 7 AS Runtime license for 100 POs and System Expansion Card PO 200M						
Type of delivery						
• Individual components, not pre-assembled	5					
• Pre-assembled and tested	6					
Sync modules and cables						
• 2 × 2 sync modules V8 XTR for distances up to 10 m and 2 × FO sync cable, 1 m			3			
Additive Industrial Ethernet interface modules						
• Without CP 443-1					0	
• 1 × 2 CP 443-1					3	
• 2 × 2 CP 443-1					4	
Racks						
• 1 × UR2-H XTR (2 × 9 slots), aluminum ¹⁾						1
• 2 × UR2 XTR (9 slots), aluminum ¹⁾						3
• 2 × CR3 XTR, 4 slots, aluminum ²⁾						7
Power supply (without backup batteries)						
• 2 × PS 407, 4 A XTR for 120/230 V UC ³⁾						A
• 2 × PS 407, 10 A XTR for 120/230 V UC, optional redundancy						C
• 2 × 2 PS 407, 10 A XTR for 120/230 V UC, redundant						E
• 2 × PS 405, 4 A XTR for 24 V DC ³⁾						F
• 2 × PS 405, 10 A XTR for 24 V DC, optional redundancy						H
• 2 × 2 PS 405, 10 A XTR for 24 V DC, redundant						K
Additive PROFIBUS DP interface modules						
• Without CP 443-5 Extended						0

¹⁾ Only in conjunction with 10 A power supplies

²⁾ Only in conjunction with 4 A power supplies

³⁾ Only in conjunction with CR3 rack

SIMATIC PCS 7 system hardware

Automation systems

AS 410-5H and AS 410E modular systems

High-availability automation systems**Ordering data****Article No.****Article No.****Individual components**

Individual components of the high availability SIMATIC PCS 7 automation systems AS 410H

CPU 410-5H Process Automation as spare part

Conformal coating; for operating temperature up to 70 °C

32 MB work memory integrated (16 MB each for program and data); module occupies 2 slots

6ES7410-5HX08-0AB0

CPU 410-5H Process Automation 100 PO Bundle

CPU bundle, consisting of CPU 410-5H Process Automation and PCS 7 System Expansion Card for 100 PO

6ES7654-5CJ00-0XF0

CPU 410-5H Process Automation 500 PO Bundle

CPU bundle, consisting of CPU 410-5H Process Automation and PCS 7 System Expansion Card for 500 PO

6ES7654-5CL00-0XF0

CPU 410-5H Process Automation 1 000 PO Bundle

CPU bundle, consisting of CPU 410-5H Process Automation and PCS 7 System Expansion Card for 1 000 PO

6ES7654-5CN00-0XF0

CPU 410-5H Process Automation 1 600 PO Bundle

CPU bundle, consisting of CPU 410-5H Process Automation and PCS 7 System Expansion Card for 1 600 PO

6ES7654-5CP00-0XF0

CPU 410-5H Process Automation PO 2k+ Bundle

CPU bundle, consisting of CPU 410-5H Process Automation and PCS 7 System Expansion Card for PO 2k+ (≥ 2 000)

6ES7654-5CQ00-0XF0

CPU 410 Expansion Pack

For subsequent increase in performance of the CPU 410-5H process automation

Language-neutral, without SIMATIC PCS 7 Software Media Package

- Goods delivery
 - License key on USB flash drive, Certificate of License

- 100 PO, license for upgrading 1 CPU

6ES7653-2CA00-0XE0

- 500 PO, license for upgrading 1 CPU

6ES7653-2CC00-0XE0

- PN RED for use of redundant PROFINET (R1), with 2 licenses for upgrading an H system

6ES7653-2CX01-0XE0

- Online delivery
 - License key download, online Certificate of License
- Note: Email address required!

- 100 PO, license for upgrading 1 CPU

6ES7653-2CA00-0XK0

- 500 PO, license for upgrading 1 CPU

6ES7653-2CC00-0XK0

- PN RED for use of redundant PROFINET (R1), with 2 licenses for upgrading an H system

6ES7653-2CX01-0XK0

Sync set

For coupling two redundant CPUs; for distances up to

- 10 m, consisting of 4 sync modules for up to 10 m and 2 FO sync cables, 1 m each
 - 10 km, consisting of 4 sync modules for up to 10 km
- Note: please order fiber-optic sync cables (2 units) in the required length separately.

6ES7656-7XX30-0XE0

6ES7656-7XX40-0XE0

Sync module

For coupling two redundant CPUs; 2 modules required for each CPU; for distances up to

- 10 m
- 10 km

6ES7960-1AA06-0XA0

6ES7960-1AB06-0XA0

Sync module V8 XTR

(Conformal coating; for operating temperature up to 70 °C) For coupling two redundant CPUs; 2 modules required for each CPU; for distances up to 10 m

6ES7960-1AA08-0XA0

Sync cable (fiber-optic connecting cable)

For connecting two redundant CPUs, 2 cables required for each redundant automation system

- 1 m
- 2 m
- 10 m

6ES7960-1AA04-5AA0

6ES7960-1AA04-5BA0

6ES7960-1AA04-5KA0

Other lengths

On request

PS 407 power supply module

with battery compartment for 2 backup batteries, module occupies 2 slots

- **4 A XTR** (conformal coating; for operating temperature up to 70 °C) 120/230 V UC; 5 V DC/4 A, 24 V DC/0.5 A

6ES7407-0DA02-0AA1

- **10 A** 120/230 V UC; 5 V DC/10 A, 24 V DC/1 A

6ES7407-0KA02-0AA0

- **10 A XTR, optional redundancy** (conformal coating; for operating temperature up to 70 °C) 120/230 V UC; 5 V DC/10 A, 24 V DC/1 A

6ES7407-0KR02-0AA1

- **20 A** 120/230 V UC; 5 V DC/20 A, 24 V DC/1 A

6ES7407-0RA02-0AA0

PS 405 power supply module

with battery compartment for 2 backup batteries, module occupies 2 slots

- **4 A XTR** (conformal coating; for operating temperature up to 70 °C) 24/48/60 V DC; 5 V DC/4 A, 24 V DC/0.5 A

6ES7405-0DA02-0AA1

- **10 A** 24/48/60 V DC; 5 V DC/10 A, 24 V DC/1 A

6ES7405-0KA02-0AA0

- **10 A XTR, optional redundancy** (conformal coating; for operating temperature up to 70 °C) 24/48/60 V DC; 5 V DC/10 A, 24 V DC/1 A

6ES7405-0KR02-0AA1

- **20 A** 24/48/60 V DC; 5 V DC/20 A, 24 V DC/1 A; with battery compartment for 2 backup batteries, module occupies 2 slots

6ES7405-0RA02-0AA0

Ordering data	Article No.		Article No.
Backup battery For PS 405/407, type AA, 3.6 V, 2.3 Ah	6ES7971-0BA00		Runtime licenses for SIMATIC PCS 7 automation systems (can be added to existing licenses)
XTR backup battery For PS 405/407, type AA, 3.6 V, 2.3 Ah; for operating temperatures up to 70 °C	6ES7971-0BA02		SIMATIC PCS 7 AS Runtime license Language-neutral, floating license for 1 user Without SIMATIC PCS 7 Software Media Package
Aluminum rack • UR1, 18 slots • UR2 XTR, 9 slots (conformal coating; for operating temperature up to 70 °C) • UR2-H XTR, for divided central controllers; 2 × 9 slots (conformal coating; for operating temperature up to 70 °C) • CR3 XTR, 4 slots (conformal coating; for operating temperature up to 70 °C)	6ES7400-1TA11-0AA0 6ES7400-1JA11-0AA1 6ES7400-2JA10-0AA1 6ES7401-1DA01-0AA1		• Goods delivery License key on USB flash drive, Certificate of License - 100 POs - 1 000 POs - 10 000 POs • Online delivery License key download, online Certificate of License <u>Note:</u> Email address required! - 100 POs - 1 000 POs - 10 000 POs
Steel rack • UR1, 18 slots • UR2, 9 slots • UR2-H, for divided central controllers; 2 × 9 slots	6ES7400-1TA01-0AA0 6ES7400-1JA01-0AA0 6ES7400-2JA00-0AA0		Y-Link For connection of devices with only 1 PROFIBUS DP interface to a redundant automation system
Individual components for AS 410HE high availability automation systems			
CPU 410E Process Automation as spare part Conformal coating; for operating temperature up to 70 °C 4 MB work memory integrated (2 MB each for program and data); module occupies 2 slots	6ES7410-5HM08-0AB0		

Options

Y-Link

- Bus coupler for transition from a redundant PROFIBUS DP master system to a single-channel PROFIBUS DP master system
- For connection of devices with only one PROFIBUS DP interface to the redundant PROFIBUS DP master system

The Y-link comprises:

- 2 IM 153-2 High Feature Outdoor high feature interface modules
- One Y coupler including RS 485 repeater
- One BM IM/IM bus module for two IM 153-2 High Feature Outdoor modules
- One BM Y coupler bus module

Evaluation of the Y-Link diagnostics (and hence indirectly of the connected DP standard slaves) is supported by driver blocks.

SIMATIC PCS 7 system hardware

Automation systems

AS 410-5H and AS 410E modular systems

Safety-related automation systems

Overview



AS Single Station AS 410F

Safety-related automation systems are used for critical applications where a fault could endanger life or result in damage to the plant or the environment. These F/FH systems also referred to as "fail-safe automation systems" detect both faults in the process and their own internal faults in association with the safety-related F modules of the ET 200 distributed I/O systems or fail-safe transmitters connected directly via the fieldbus. They automatically transfer the plant to a safe state in the event of a fault.

Design

The PROFIsafe profile allows safety-related communication between the automation system (controller) and the process I/O via both PROFIBUS and PROFINET. The decision for choosing either PROFINET IO or the PROFIBUS DP/PA fieldbuses has a significant influence on the architecture of the safety-related system.

For information on the safety-related design versions with PROFIBUS DP/PA and PROFINET IO, refer to the section "Safety Integrated for Process Automation", "Introduction".

The safety-related SIMATIC PCS 7 automation systems are based either on the hardware of the AS 410S standard automation system (F systems) or the hardware of the AS 410H high availability automation system (FH systems), which have been supplemented with safety functions using SIMATIC S7 F systems.

In accordance with the design variant, they are categorized as:

- **AS Single Station AS 410F** with only one CPU (safety-related)
- **AS Redundancy Station AS 410FH** with two redundant CPUs (safety-related and high availability)

Availability can be flexibly increased with a redundant design for the power supply or the Industrial Ethernet communications module (for details, see the section "Modular AS 410 systems" under "Flexible and scalable availability").

All AS 410F/FH systems are TÜV-certified and comply with the safety requirements up to SIL 3 according to IEC 61508.

In these systems with multitasking capability, several programs can be executed simultaneously in one CPU – basic process control (BPCS) applications or also safety-related applications. The programs are reaction-free, i.e. faults in BPCS applications have no effect on safety-related applications, and vice versa. Special tasks with very short response times can also be implemented.

The redundant FH systems operating according to the 1-out-of-2 principle consist of two subsystems of identical design. These are electrically isolated from each other to achieve optimum EMC, and are synchronized with each other via fiber-optic cables. In case of an error, there is a bumpless switchover from the active subsystem to the reserve system. The two subsystems can be present in the same rack or separated by up to 10 km. The spatial separation provides additional security in the case of extreme influences in the environment of the active subsystem, e.g. resulting from a fire.

The redundancy of the FH systems is only used to increase the availability. It is not relevant to processing of the safety functions and the associated fault detection.

Design (continued)

Individual configuration of AS bundles

Configuration of the safety-related automation systems as well as the Article No.'s can be defined by selecting pre-configured ordering units.

Typical combinations for the respective system can be selected using tables in the "Ordering data" section. These are divided into:

- AS Single Station AS 410F with one CPU
- AS Redundancy Station AS 410FH with two redundant CPUs, mounted on one common rack (UR2-H) or two separate racks (UR2)

The complete range for selection is available using two correspondingly structured online configurators in the Industry Mall:

- SIMATIC PCS 7 AS 410 Single Station configurator
- SIMATIC PCS 7 AS 410 Redundancy Station configurator

System expansion cards including a SIMATIC S7 F Systems Runtime License should be selected for safety-related AS 410 F/FH automation systems.

FO sync cables longer than 1 m must always be ordered separately (2 cables required in each case).

The components suitable for engineering the safety-related applications can be ordered in the section "Safety Integrated for Process Automation":

- SIMATIC S7 F Systems
F programming tool with F block library for programming safety-related user programs on the engineering system
- SIMATIC S7 Safety Matrix
Convenient safety lifecycle tool for configuration, operation and servicing

Subsequent increase in performance/ use of redundant PROFINET (R1)

If the performance limit defined by the ordered system expansion card is reached during configuration, commissioning or operation, a subsequent increase in performance is possible by using an appropriate number of CPU 410 Expansion Packs 100 POs/500 POs. Hardware modifications are not necessary.

Aside from increasing performance, the redundancy functions of PROFINET can also be expanded. If a redundant PROFINET (R1) is to be used in place of PROFINET system redundancy (S2), this function can be expanded with the "CPU 410 Expansion Pack PN Red".

I/O connection via PROFIBUS DP

The distributed process I/O can be integrated into a PROFIBUS DP segment either directly or via a lower-level PROFIBUS PA fieldbus. Several PROFIBUS DP segments with distributed process I/Os can be operated on an AS 410F/FH automation system.

A PROFIBUS DP interface is already integrated in each CPU 410-5H Process Automation. Using the online configurator in the Industry Mall or in the selection and ordering data, up to four additional PROFIBUS DP interfaces can be configured with additive CP 443-5 PROFIBUS DP interfaces (conformal coating) for each AS 410F as well as for each subsystem of the AS 410FH.

Connection of the process I/Os to two redundant PROFIBUS DP lines of an FH system (AS Redundancy Station) is carried out as described in the section "High availability automation systems".

The FOUNDATION Fieldbus (FF) H1 and the FF devices are not supported by Safety Integrated for Process Automation.

I/O connection via PROFINET IO

Safety-related AS 410F/FH automation systems can be connected via PROFINET IO with remote I/O stations, for example, ET 200M or ET 200SP remote I/O stations. Only the two PROFINET interfaces (2-port switches) integrated in the CPU can be used for this on the automation system. You can find more information in the section "Safety Integrated for Process Automation", "Introduction".

Communication over the plant bus

If the PROFINET interfaces integrated in the CPU of the safety-related automation systems are not used for PROFINET IO, they are then available for connection to the Industrial Ethernet plant bus. Otherwise, the AS 410F and the two subsystems of the AS 410FH can be connected to the plant bus via one CP 443-1 (conformal coating) communication module each.

The plant bus can be implemented in the form of a ring structure, which can also be configured with redundant architecture if the availability requirements are high. When there are two redundant rings, it makes sense to configure two IE interface/communication modules per AS (AS 410F) or AS subsystem (AS 410FH) and to distribute their connections over the two rings (4-way connection). Double faults such as failure of the switch on ring 1 with simultaneous interruption of the bus cable on ring 2 can thus be tolerated.

Runtime licenses

Safety-related automation systems come furnished with the SIMATIC PCS 7 AS Runtime license for 100 process objects (PO) and the SIMATIC S7 F Systems RT license. The 100 POs of the SIMATIC PCS 7 AS Runtime license can be expanded by additional Runtime licenses for 100, 1 000 or 10 000 POs. The process objects of additional Runtime licenses can be added to process objects which already exist. The number and type (e.g. 100 or 1000) of additional Runtime licenses are irrelevant.

SIMATIC PCS 7 system hardware

Automation systems

AS 410-5H and AS 410E modular systems

Safety-related automation systems**Ordering data****Safety-oriented automation systems with CPU 410-5H**

	Article No.					
AS 410F (single station) CPU 410-5H with PROFIBUS DP and PROFINET IO interface 32 MB work memory (16 MB each for program and data) with SIMATIC PCS 7 AS runtime license for 100 POs	6ES7654-					
	C	0	-	F		
Type of delivery						
• Individual components, not pre-assembled	5					
• Pre-assembled and tested	6					
System Expansion Card						
• System Expansion Card 100 POs incl. SIMATIC S7 F-systems runtime license		A				
• System Expansion Card 500 POs incl. SIMATIC S7 F-systems runtime license		C				
• System Expansion Card 1 000 PO incl. SIMATIC S7 F-systems runtime license		E				
• System Expansion Card 1 600 PO incl. SIMATIC S7 F-systems runtime license		F				
• System Expansion Card PO 2k+ (≥ 2 000) incl. SIMATIC S7 F-systems runtime license		G				
• System Expansion Card 0 PO (empty) incl. SIMATIC S7 F-systems runtime license		H				
Additive Industrial Ethernet interface modules¹⁾						
• Without CP 443-1		0				
• 1 × CP 443-1 ²⁾		3				
• 2 × CP 443-1 ²⁾		4				
Racks						
• UR2 (9 slots), aluminum ¹⁾²⁾			3			
• UR2 (9 slots), steel ¹⁾			4			
• UR1 (18 slots), aluminum			5			
• UR1 (18 slots), steel			6			
• CR3 (4 slots), aluminum ²⁾³⁾			7			
Power supply (without backup batteries)						
• 1 × PS 407, 4 A for 120/230 V UC ²⁾⁴⁾				A		
• 1 × PS 407, 10 A for 120/230 V UC				B		
• 1 × PS 407, 10 A for 120/230 V UC, optional redundancy ²⁾				C		
• 1 × PS 407, 20 A for 120/230 V UC				D		
• 2 × PS 407, 10 A for 120/230 V UC, redundant ²⁾				E		
• 1 × PS 405, 4 A for 24 V DC ²⁾⁴⁾				F		
• 1 × PS 405, 10 A for 24 V DC				G		
• 1 × PS 405, 10 A for 24 V DC, optional redundancy ²⁾				H		
• 1 × PS 405, 20 A for 24 V DC				J		
• 2 × PS 405, 10 A for 24 V DC, redundant ²⁾				K		
Additive PROFIBUS DP interface modules¹⁾						
• Without CP 443-5 Extended						0
• 1 × CP 443-5 Extended ²⁾						1
• 2 × CP 443-5 Extended ²⁾						2
• 3 × CP 443-5 Extended ²⁾						3
• 4 × CP 443-5 Extended ²⁾						4

¹⁾ Up to 5 CPs (Industrial Ethernet/PROFIBUS) can be plugged into the UR2 rack with a single power supply, or up to 3 CPs with a redundant power supply.

²⁾ Conformal coating

³⁾ Only in conjunction with 4 A power supplies

⁴⁾ Only in conjunction with CR3 rack

	Article No.					
AS 410FH (Redundancy Station) 2 × CPU 410-5H with PROFIBUS DP and PROFINET IO interface 32 MB work memory (16 MB each for program and data) with SIMATIC PCS 7 AS Runtime license for 100 POs	6ES7656-					
	C	0	-	F		
Type of delivery						
• Individual components, not pre-assembled	5					
• Pre-assembled and tested	6					
System Expansion Card						
• 2 × System Expansion Card 100 PO incl. SIMATIC S7 F-systems runtime license		A				
• 2 × System Expansion Card 500 PO incl. SIMATIC S7 F-systems runtime license		C				
• 2 × System Expansion Card 1 000 PO incl. SIMATIC S7 F-systems runtime license		E				
• 2 × System Expansion Card 1 600 PO incl. SIMATIC S7 F-systems runtime license		F				
• 2 × System Expansion Card PO 2k+ (≥ 2 000) incl. SIMATIC S7 F-systems runtime license		G				
• 2 × System Expansion Card 0 PO (empty) incl. SIMATIC S7 F-systems runtime license		H				
Sync modules and cables						
• 2 × 2 sync modules ²⁾ for distances up to 10 m and 2 × FO sync cable, 1 m			3			
• 2 × 2 sync modules for up to 10 km and 2 × FO sync cable, 1 m, for testing			4			
Additive Industrial Ethernet interface modules¹⁾						
• Without CP 443-1						0
• 2 × 1 CP 443-1 ²⁾						3
• 2 × 2 CP 443-1 ²⁾						4
Racks						
• 1 × UR2-H (2 × 9 slots), aluminum ¹⁾²⁾						1
• 1 × UR2-H (2 × 9 slots), steel ¹⁾						2
• 2 × UR2 (9 slots), aluminum ¹⁾²⁾						3
• 2 × UR2 (9 slots), steel ¹⁾						4
• 2 × CR3 (4 slots), aluminum ²⁾³⁾						7
Power supply (without backup batteries)						
• 2 × PS 407, 4 A for 120/230 V UC ²⁾⁴⁾						A
• 2 × PS 407, 10 A for 120/230 V UC						B
• 2 × PS 407, 10 A for 120/230 V UC, optional redundancy ²⁾						C
• 2 × PS 407, 20 A for 120/230 V UC						D
• 2 × 2 PS 407, 10 A for 120/230 V UC, redundant ²⁾						E
• 2 × PS 405, 4 A for 24 V DC ²⁾⁴⁾						F
• 2 × PS 405, 10 A for 24 V DC						G
• 2 × PS 405, 10 A for 24 V DC, optional redundancy ²⁾						H
• 2 × PS 405, 20 A for 24 V DC						J
• 2 × 2 PS 405, 10 A for 24 V DC, redundant ²⁾						K
Additive PROFIBUS DP interface modules¹⁾						
• Without CP 443-5 Extended						0
• 2 × 1 CP 443-5 Extended ²⁾						1
• 2 × 2 CP 443-5 Extended ²⁾						2
• 2 × 3 CP 443-5 Extended ²⁾						3
• 2 × 4 CP 443-5 Extended ²⁾						4

¹⁾ In configurations with UR2/UR2-H racks, up to 5 CPs (Industrial Ethernet/PROFIBUS) can be configured with a single power supply per subsystem, or up to 3 CPs per subsystem with a redundant power supply.

²⁾ Conformal coating

³⁾ Only in conjunction with 4 A power supplies

⁴⁾ Only in conjunction with CR3 rack

Ordering data (continued)

Safety-oriented automation systems with CPU 410-5H for the expanded temperature range (XTR)

	Article No.								Article No.							
AS 410F (single station) CPU 410-5H with PROFIBUS DP and PROFINET IO interface 32 MB work memory (16 MB each for program and data) with SIMATIC PCS 7 AS runtime license for 100 POs	6ES7654-							AS 410FH (Redundancy Station) 2 × CPU 410-5H with PROFIBUS DP and PROFINET IO interface 32 MB work memory (16 MB each for program and data) with SIMATIC PCS 7 AS Runtime license for 100 POs	6ES7656-							
	C		0		-		F		C				-			F
Type of delivery • Individual components, not pre-assembled • Pre-assembled and tested	5							5								
System Expansion Card • System Expansion Card 100 POs incl. SIMATIC S7 F-systems runtime license • System Expansion Card 500 POs incl. SIMATIC S7 F-systems runtime license • System Expansion Card 1 000 PO incl. SIMATIC S7 F-systems runtime license • System Expansion Card 1 600 PO incl. SIMATIC S7 F-systems runtime license • System Expansion Card PO 2k+ (≥ 2 000) incl. SIMATIC S7 F-systems runtime license • System Expansion Card 0 PO (empty) incl. SIMATIC S7 F-systems runtime license		A							A							
		C							C							
		E							E							
		F							F							
		G							G							
		H							H							
Additive Industrial Ethernet interface modules • Without CP 443-1 • 1 × CP 443-1 • 2 × CP 443-1			0													
			3													
			4													
Racks • UR2 XTR (9 slots), aluminum ¹⁾ • CR3 XTR, 4 slots, aluminum ²⁾					3											
					7											
Power supply (without backup batteries) • 1 × PS 407, 4 A XTR for 120/230 V UC ³⁾ • 1 × PS 407, 10 A XTR for 120/230 V UC, optional redundancy • 2 × PS 407, 10 A XTR for 120/230 V UC, redundant • 1 × PS 405, 4 A XTR for 24 V DC ³⁾ • 1 × PS 405, 10 A XTR for 24 V DC, optional redundancy • 2 × PS 405, 10 A XTR for 24 V DC, redundant						A										
						C										
						E										
						F										
						H										
						K										
Additive PROFIBUS DP interface modules • Without CP 443-5 Extended							0									
Sync modules and cables • 2 × 2 sync modules V8 XTR for distances up to 10 m and 2 × FO sync cable, 1 m								3								
Additive Industrial Ethernet interface modules • Without CP 443-1 • 1 × 2 CP 443-1 • 2 × 2 CP 443-1									0							
									3							
									4							
Racks • 1 × UR2-H XTR (2 × 9 slots), aluminum ¹⁾ • 2 × UR2 XTR (9 slots), aluminum ¹⁾ • 2 × CR3 XTR, 4 slots, aluminum ²⁾														1		
														3		
														7		
Power supply (without backup batteries) • 2 × PS 407, 4 A XTR for 120/230 V UC ³⁾ • 2 × PS 407, 10 A XTR for 120/230 V UC, optional redundancy • 2 × 2 PS 407, 10 A XTR for 120/230 V UC, redundant • 2 × PS 405, 4 A XTR for 24 V DC ³⁾ • 2 × PS 405, 10 A XTR for 24 V DC, optional redundancy • 2 × 2 PS 405, 10 A XTR for 24 V DC, redundant															A	
															C	
															E	
															F	
															H	
															K	
Additive PROFIBUS DP interface modules • Without CP 443-5 Extended																0

1) Only in conjunction with 10 A power supplies

2) Only in conjunction with 4 A power supplies

3) Only in conjunction with CR3 rack

1) Only in conjunction with 10 A power supplies

2) Only in conjunction with 4 A power supplies

3) Only in conjunction with CR3 rack

SIMATIC PCS 7 system hardware

Automation systems

AS 410-5H and AS 410E modular systems

Safety-related automation systems

Ordering data

Safety-oriented automation systems with CPU 410E

	Article No.					
	6ES7654-					
	E	B	0	-	F	
AS 410FE (single station) CPU 410E with PROFIBUS DP and PROFINET IO interface 4 MB work memory (2 MB each for program and data) with SIMATIC PCS 7 AS runtime license for 100 POs and System Expansion Card PO 200M						
Type of delivery						
• Individual components, not pre-assembled	5					
• Pre-assembled and tested	6					
Additive Industrial Ethernet interface modules¹⁾						
• Without CP 443-1			0			
• 1 × CP 443-1 ²⁾			3			
• 2 × CP 443-1 ²⁾			4			
Racks						
• UR2 (9 slots), aluminum ¹⁾²⁾					3	
• UR2 (9 slots), steel ¹⁾					4	
• CR3 (4 slots), aluminum ²⁾³⁾					7	
Power supply (without backup batteries)						
• 1 × PS 407, 4 A for 120/230 V UC ²⁾⁴⁾						A
• 1 × PS 407, 10 A for 120/230 V UC						B
• 1 × PS 407, 10 A for 120/230 V UC, optional redundancy ²⁾						C
• 2 × PS 407, 10 A for 120/230 V UC, redundant ²⁾						E
• 1 × PS 405, 4 A for 24 V DC ²⁾⁴⁾						F
• 1 × PS 405, 10 A for 24 V DC						G
• 1 × PS 405, 10 A for 24 V DC, optional redundancy ²⁾						H
• 2 × PS 405, 10 A for 24 V DC, redundant ²⁾						K
Additive PROFIBUS DP interface modules¹⁾						
• Without CP 443-5 Extended						0
• 1 × CP 443-5 Extended ²⁾						1
• 2 × CP 443-5 Extended ²⁾						2
• 3 × CP 443-5 Extended ²⁾						3
• 4 × CP 443-5 Extended ²⁾						4

¹⁾ Up to 5 CPs (Industrial Ethernet/PROFIBUS) can be plugged into the UR2 rack with a single power supply, or up to 3 CPs with a redundant power supply.

²⁾ Conformal coating

³⁾ Only in conjunction with 4 A power supplies

⁴⁾ Only in conjunction with CR3 rack

	Article No.					
	6ES7656-					
	E	B	0	-	F	
AS 410FHE (Redundancy Station) 2 × CPU 410E with PROFIBUS DP and PROFINET IO interface 4 MB work memory (2 MB each for program and data) with SIMATIC PCS 7 AS Runtime license for 100 POs and System Expansion Card PO 200M						
Type of delivery						
• Individual components, not pre-assembled	5					
• Pre-assembled and tested	6					
Sync modules and cables						
• 2 × 2 sync modules ²⁾ for distances up to 10 m and 2 × FO sync cable, 1 m					3	
• 2 × 2 sync modules for up to 10 km and 2 × FO sync cable, 1 m, for testing					4	
Additive Industrial Ethernet interface modules¹⁾						
• Without CP 443-1						0
• 2 × 1 CP 443-1 ²⁾						3
• 2 × 2 CP 443-1 ²⁾						4
Racks						
• 1 × UR2-H (2 × 9 slots), aluminum ¹⁾²⁾						1
• 1 × UR2-H (2 × 9 slots), steel ¹⁾						2
• 2 × UR2 (9 slots), aluminum ¹⁾²⁾						3
• 2 × UR2 (9 slots), steel ¹⁾						4
• 2 × CR3 (4 slots), aluminum ²⁾³⁾						7
Power supply (without backup batteries)						
• 2 × PS 407, 4 A for 120/230 V UC ²⁾⁴⁾						A
• 2 × PS 407, 10 A for 120/230 V UC						B
• 2 × PS 407, 10 A for 120/230 V UC, optional redundancy ²⁾						C
• 2 × PS 407, 20 A for 120/230 V UC						D
• 2 × 2 PS 407, 10 A for 120/230 V UC, redundant ²⁾						E
• 2 × PS 405, 4 A for 24 V DC ²⁾⁴⁾						F
• 2 × PS 405, 10 A for 24 V DC						G
• 2 × PS 405, 10 A for 24 V DC, optional redundancy ²⁾						H
• 2 × PS 405, 20 A for 24 V DC						J
• 2 × 2 PS 405, 10 A for 24 V DC, redundant ²⁾						K
Additive PROFIBUS DP interface modules¹⁾						
• Without CP 443-5 Extended						0
• 2 × 1 CP 443-5 Extended ²⁾						1
• 2 × 2 CP 443-5 Extended ²⁾						2
• 2 × 3 CP 443-5 Extended ²⁾						3
• 2 × 4 CP 443-5 Extended ²⁾						4

¹⁾ In configurations with UR2/UR2-H racks, up to 5 CPs (Industrial Ethernet/PROFIBUS) can be configured with a single power supply per subsystem, or up to 3 CPs per subsystem with a redundant power supply.

²⁾ Conformal coating

³⁾ Only in conjunction with 4 A power supplies

⁴⁾ Only in conjunction with CR3 rack

Ordering data (continued)

Safety-oriented automation systems with CPU 410E for the expanded temperature range (XTR)

	Article No.					
AS 410FE (single station) CPU 410E with PROFIBUS DP and PROFINET IO interface 4 MB work memory (2 MB each for program and data) with SIMATIC PCS 7 AS runtime license for 100 POs and System Expansion Card PO 200M	6ES7654-					
	E	B	0	-	F	0
Type of delivery						
• Individual components, not pre-assembled	5					
• Pre-assembled and tested	6					
Additive Industrial Ethernet interface modules						
• Without CP 443-1			0			
• 1 × CP 443-1			3			
• 2 × CP 443-1			4			
Racks						
• UR2 XTR (9 slots), aluminum ¹⁾				3		
• CR3 XTR, 4 slots, aluminum ²⁾				7		
Power supply (without backup batteries)						
• 1 × PS 407, 4 A XTR for 120/230 V UC ³⁾					A	
• 1 × PS 407, 10 A XTR for 120/230 V UC, optional redundancy					C	
• 2 × PS 407, 10 A XTR for 120/230 V UC, redundant					E	
• 1 × PS 405, 4 A XTR for 24 V DC ³⁾					F	
• 1 × PS 405, 10 A XTR for 24 V DC, optional redundancy					H	
• 2 × PS 405, 10 A XTR for 24 V DC, redundant					K	
Additive PROFIBUS DP interface modules						
• Without CP 443-5 Extended						0
¹⁾ Only in conjunction with 10 A power supplies ²⁾ Only in conjunction with 4 A power supplies ³⁾ Only in conjunction with CR3 rack						

	Article No.					
AS 410FHE (Redundancy Station) 2 × CPU 410E with PROFIBUS DP and PROFINET IO interface 4 MB work memory (2 MB each for program and data) with SIMATIC PCS 7 AS Runtime license for 100 POs and System Expansion Card PO 200M	6ES7656-					
	E	B	-	F	0	
Type of delivery						
• Individual components, not pre-assembled	5					
• Pre-assembled and tested	6					
Sync modules and cables						
• 2 × 2 sync modules V8 XTR for distances up to 10 m and 2 × FO sync cable, 1 m		3				
Additive Industrial Ethernet interface modules						
• Without CP 443-1			0			
• 1 × 2 CP 443-1			3			
• 2 × 2 CP 443-1			4			
Racks						
• 1 × UR2-H XTR (2 × 9 slots), aluminum ¹⁾					1	
• 2 × UR2 XTR (9 slots), aluminum ¹⁾					3	
• 2 × CR3 XTR, 4 slots, aluminum ²⁾					7	
Power supply (without backup batteries)						
• 2 × PS 407, 4 A XTR for 120/230 V UC ³⁾					A	
• 2 × PS 407, 10 A XTR for 120/230 V UC, optional redundancy					C	
• 2 × 2 PS 407, 10 A XTR for 120/230 V UC, redundant					E	
• 2 × PS 405, 4 A XTR for 24 V DC ³⁾					F	
• 2 × PS 405, 10 A XTR for 24 V DC, optional redundancy					H	
• 2 × 2 PS 405, 10 A XTR for 24 V DC, redundant					K	
Additive PROFIBUS DP interface modules						
• Without CP 443-5 Extended						0
¹⁾ Only in conjunction with 10 A power supplies ²⁾ Only in conjunction with 4 A power supplies ³⁾ Only in conjunction with CR3 rack						

SIMATIC PCS 7 system hardware

Automation systems

AS 410-5H and AS 410E modular systems

Safety-related automation systems

Ordering data

Article No.

Article No.

Individual components

Ordering data	Article No.	Article No.
Individual components of the safety-oriented SIMATIC PCS 7 AS 410F and AS 410FH automation systems		
SIMATIC S7 F-systems RT license For processing safety-oriented user programs, for one AS 410F/FH system each	6ES7833-1CC00-6YX0	
CPU 410-5H Process Automation as spare part Conformal coating; for operating temperature up to 70 °C 32 MB work memory integrated (16 MB each for program and data); module occupies 2 slots	6ES7410-5HX08-0AB0	
CPU 410-5H Process Automation 100 PO Bundle CPU bundle, consisting of CPU 410-5H Process Automation and PCS 7 System Expansion Card for 100 PO	6ES7654-5CJ00-0XF0	
CPU 410-5H Process Automation 500 PO Bundle CPU bundle, consisting of CPU 410-5H Process Automation and PCS 7 System Expansion Card for 500 PO	6ES7654-5CL00-0XF0	
CPU 410-5H Process Automation 1 000 PO Bundle CPU bundle, consisting of CPU 410-5H Process Automation and PCS 7 System Expansion Card for 1 000 PO	6ES7654-5CN00-0XF0	
CPU 410-5H Process Automation 1 600 PO Bundle CPU bundle, consisting of CPU 410-5H Process Automation and PCS 7 System Expansion Card for 1 600 PO	6ES7654-5CP00-0XF0	
CPU 410-5H Process Automation PO 2k+ Bundle CPU bundle, consisting of CPU 410-5H Process Automation and PCS 7 System Expansion Card for PO 2k+ (≥ 2 000)	6ES7654-5CQ00-0XF0	
CPU 410 Expansion Pack For subsequent increase in performance of the CPU 410-5H process automation Language-neutral, without SIMATIC PCS 7 Software Media Package <ul style="list-style-type: none"> Goods delivery License key on USB flash drive, Certificate of License <ul style="list-style-type: none"> - 100 PO, license for upgrading 1 CPU - 500 PO, license for upgrading 1 CPU - PN RED for use of redundant PROFINET (R1), with 2 licenses for upgrading an H system Online delivery License key download, online Certificate of License Note: Email address required! <ul style="list-style-type: none"> - 100 PO, license for upgrading 1 CPU - 500 PO, license for upgrading 1 CPU - PN RED for use of redundant PROFINET (R1), with 2 licenses for upgrading an H system 	6ES7653-2CA00-0XE0 6ES7653-2CC00-0XE0 6ES7653-2CX01-0XE0 6ES7653-2CA00-0XK0 6ES7653-2CC00-0XK0 6ES7653-2CX01-0XK0	
Sync set For coupling two redundant CPUs; for distances up to <ul style="list-style-type: none"> 10 m, consisting of 4 sync modules for up to 10 m and 2 fiber-optic sync cables, 1 m each 10 km, consisting of 4 sync modules for up to 10 km Note: please order fiber-optic sync cables (2 units) in the required length separately. 		6ES7656-7XX30-0XE0 6ES7656-7XX40-0XE0
Sync module For coupling two redundant CPUs; 2 modules required for each CPU, for distances up to <ul style="list-style-type: none"> 10 m 10 km 		6ES7960-1AA06-0XAA0 6ES7960-1AB06-0XAA0
Sync module V8 XTR (Conformal coating; for operating temperature up to 70 °C) For coupling two redundant CPUs; 2 modules required for each CPU; for distances up to 10 m		6ES7960-1AA08-0XAA0
Sync cable (fiber-optic connecting cable) For connecting two redundant CPUs, 2 cables required for each redundant automation system <ul style="list-style-type: none"> 1 m 2 m 10 m Other lengths		6ES7960-1AA04-5AA0 6ES7960-1AA04-5BA0 6ES7960-1AA04-5KA0 On request
PS 407 power supply module with battery compartment for 2 backup batteries, module occupies 2 slots <ul style="list-style-type: none"> 4 A XTR (conformal coating; for operating temperature up to 70 °C) 120/230 V UC; 5 V DC/4 A, 24 V DC/0.5 A 10 A 120/230 V UC; 5 V DC/10 A, 24 V DC/1 A 10 A XTR, optional redundancy (conformal coating; for operating temperature up to 70 °C) 120/230 V UC; 5 V DC/10 A, 24 V DC/1 A 20 A 120/230 V UC; 5 V DC/20 A, 24 V DC/1 A 		6ES7407-0DA02-0AA1 6ES7407-0KA02-0AA0 6ES7407-0KR02-0AA1 6ES7407-0RA02-0AA0
PS 405 power supply module with battery compartment for 2 backup batteries, module occupies 2 slots <ul style="list-style-type: none"> 4 A XTR (conformal coating; for operating temperature up to 70 °C) 24/48/60 V DC; 5 V DC/4 A, 24 V DC/0.5 A 10 A 24/48/60 V DC; 5 V DC/10 A, 24 V DC/1 A 10 A XTR, optional redundancy (conformal coating; for operating temperature up to 70 °C) 24/48/60 V DC; 5 V DC/10 A, 24 V DC/1 A 20 A 24/48/60 V DC; 5 V DC/20 A, 24 V DC/1 A; with battery compartment for 2 backup batteries, module occupies 2 slots 		6ES7405-0DA02-0AA1 6ES7405-0KA02-0AA0 6ES7405-0KR02-0AA1 6ES7405-0RA02-0AA0

SIMATIC PCS 7 system hardware

Automation systems

AS 410-5H and AS 410E modular systems

Safety-related automation systems

Ordering data	Article No.	Article No.
Backup battery For PS 405/407, type AA, 3.6 V, 2.3 Ah	6ES7971-0BA00	Runtime licenses for SIMATIC PCS 7 automation systems (can be added to existing licenses)
XTR backup battery For PS 405/407, type AA, 3.6 V, 2.3 Ah; for operating temperatures up to 70 °C	6ES7971-0BA02	SIMATIC PCS 7 AS Runtime license Language-neutral, floating license for 1 user Without SIMATIC PCS 7 Software Media Package <ul style="list-style-type: none"> Goods delivery <ul style="list-style-type: none"> License key on USB flash drive, Certificate of License <ul style="list-style-type: none"> - 100 POs - 1 000 POs - 10 000 POs Online delivery <ul style="list-style-type: none"> License key download, online Certificate of License Note: Email address required! <ul style="list-style-type: none"> - 100 POs - 1 000 POs - 10 000 POs
Aluminum rack <ul style="list-style-type: none"> UR1, 18 slots UR2 XTR, 9 slots (conformal coating; for operating temperature up to 70 °C) UR2-H XTR, for divided central controllers; 2 x 9 slots (conformal coating; for operating temperature up to 70 °C) CR3 XTR, 4 slots (conformal coating; for operating temperature up to 70 °C) 	6ES7400-1TA11-0AA0 6ES7400-1JA11-0AA1 6ES7400-2JA10-0AA1 6ES7401-1DA01-0AA1	6ES7653-2BA00-0XB5 6ES7653-2BB00-0XB5 6ES7653-2BC00-0XB5 6ES7653-2BA00-0XH5 6ES7653-2BB00-0XH5 6ES7653-2BC00-0XH5
Steel rack <ul style="list-style-type: none"> UR1, 18 slots UR2, 9 slots UR2-H, for divided central controllers; 2 x 9 slots 	6ES7400-1TA01-0AA0 6ES7400-1JA01-0AA0 6ES7400-2JA00-0AA0	AS 410F/FH Engineering See "Safety Integrated for Process Automation", SIMATIC S7 F-systems
Individual components for safety-oriented AS 410FE automation systems		Y-Link
CPU 410E Process Automation as spare part Conformal coating; for operating temperature up to 70 °C 4 MB work memory integrated (2 MB each for program and data); module occupies 2 slots	6ES7410-5HM08-0AB0	Y-Link For connection of devices with only one PROFIBUS DP interface to a redundant automation system

SIMATIC PCS 7 system hardware

Automation systems

Complementary S7-400 systems

Overview



AS 416-2 automation system

With the S7-400 automation systems, which are scalable via different types of CPU, you have an alternative to AS 410 automation systems. The systems that can be used in plants with SIMATIC PCS 7 V7/V8 can be classified as follows:

- Standard automation systems
- High availability automation systems
- Safety-related automation systems

Standard automation systems

The AS 414-3, AS 414-3IE, AS 416-2, AS 416-3, AS 416-3IE and AS 417-4 standard automation systems are extremely robust and feature high processing and communication performance.

The AS 414-3 and AS 414-3IE are tailored for smaller-scale applications with smaller quantity structures. This allows for a low-cost starter solution with a modular and scalable system based on the S7-400 controller range. Larger quantity frameworks can be implemented with the AS 416-2, AS416-3/416-3IE and AS 417-4 automation systems. These systems are preferred for medium and large-sized plants.

High availability automation systems

The aim in using high availability automation systems is to minimize the risk of a production outage. In accordance with their basic design, these systems are categorized as:

- AS Single Stations: AS 412-5-1H, AS 414-5-1H, AS 416-5-1H, and AS 417-5-1H with only one CPU, e.g. for the following applications:
 - Subsequent expansion to a redundant system
 - Redundant configuration on UR1 racks, comprising 2 single stations, 4 sync modules, and 2 FO sync cables
- AS Redundancy Stations: AS 412-5-2H, AS 414-5-2H, AS 416-5-2H and AS 417-5-2H with two redundant CPUs, mounted on one common rack (UR2-H) or two separate racks (UR2)

Safety-related automation systems

Safety-related automation systems (F/FH systems) are available for safety-relevant applications in which an incident can result in danger to persons, plant damage or environmental pollution. They are based on the hardware of the high availability automation systems, which is expanded by safety functions with SIMATIC S7 F systems.

In accordance with the design variant, they are categorized as:

- **AS Single Stations**
AS 412F, AS 414F, AS 416F, and AS 417F with only one CPU (safety-related)
- **AS Redundancy Stations**
AS 412FH, AS 414FH, AS 416FH, and AS 417FH with two redundant CPUs (safety-related and high availability)

The safety-related F/FH systems collaborate with safety-related F modules of the ET 200 distributed I/O systems or fail-safe transmitters connected directly via the fieldbus to detect not only faults in the process, but also their own, internal faults. They automatically transfer the plant to a safe state in the event of a fault. The redundancy of the FH systems is only used to increase the availability. It is not relevant to processing of the safety functions and the associated fault detection.

All F/FH systems are TÜV-certified and comply with the safety requirements up to SIL 3 according to IEC 61508.

Design

Racks

Automation systems based on only one CPU (AS Single Station) can be mounted on a UR1 rack (18 slots) or UR2 rack (9 slots).

The automation systems (AS Redundancy Station) consisting of two electrically isolated redundant subsystems can be mounted on a UR2-H compact rack with divided backplane bus or on two separate racks (UR1 or UR2). The design with two racks allows physical separation of the redundant subsystems, e.g. by a fireproof partition and over a distance of up to 10 km. As a result of the galvanic isolation, the system is insensitive to electromagnetic interferences.

Redundant power supply

If you have two separate power supply networks for your system, you can increase the availability of the automation systems with redundant power supplies (2 power supplies for one AS Single Station or 1 or 2 power supplies for each subsystem of an AS Redundancy Station).

Communication via the Industrial Ethernet (IE) plant bus

Each standard automation system is connected to the Industrial Ethernet plant bus by means of a CP 443-1 communication module.

If the PN/IE interfaces integrated in the CPUs of the high availability and safety-related automation systems are not used for PROFINET IO, they can then also be used for the connection to the Industrial Ethernet plant bus. Otherwise, the 1H/F systems (AS Single Station) and the two subsystems of the 2H/FH systems (AS Redundancy Station) can be connected to the plant bus via one CP 443-1 communication module each.

Design (continued)

I/O connection via PROFIBUS DP

The distributed process I/O can be integrated into a PROFIBUS DP segment either directly or via a lower-level fieldbus (PROFIBUS PA or FOUNDATION Fieldbus H1).

Several PROFIBUS DP segments with distributed process I/O can be operated on a standard automation system, an 1H/F system (AS Single Station), or a 2H/FH system (AS Redundancy Station). The following table provides an overview of the number and type of configurable PROFIBUS DP interfaces.

AS type	PROFIBUS interfaces							
	1	2	3	4	5	6	7	8
AS 412-5-1H/AS 412F	MPI/DP	DP	CP	CP	CP	CP		
AS 412-5-2H/AS 412FH	MPI/DP	DP	CP	CP	CP	CP		
AS 414-5-1H/AS 414F	MPI/DP	DP	CP	CP	CP	CP		
AS 414-5-2H/AS 414FH	MPI/DP	DP	CP	CP	CP	CP		
AS 416-5-1H/AS 416F	MPI/DP	DP	CP	CP	CP	CP		
AS 416-5-2H/AS 416FH	MPI/DP	DP	CP	CP	CP	CP		
AS 417-5-1H/AS 417F	MPI/DP	DP	CP	CP	CP	CP		
AS 417-5-2H/AS 417FH	MPI/DP	DP	CP	CP	CP	CP		
AS 416-2	MPI/DP	DP	CP	CP	CP	CP		
AS 414-3IE	MPI/DP	IF	CP	CP	CP	CP		
AS 416-3IE	MPI/DP	IF	CP	CP	CP	CP		
AS 414-3	MPI/DP	DP	IF	CP	CP	CP	CP	
AS 416-3	MPI/DP	DP	IF	CP	CP	CP	CP	
AS 417-4	MPI/DP	DP	IF	IF	CP	CP	CP	CP

Overview of number and type of configurable PROFIBUS interfaces

MPI/DP = Integrated MPI/DP interface (for up to 32 PROFIBUS DP nodes)

DP = Integrated PROFIBUS DP interface

IF = Optional PROFIBUS DP interface module

CP = Additive CP 443-5 Extended PROFIBUS DP interface

I/O connection via PROFINET (PN)

Standard automation systems, high availability and safety-oriented automation systems (AS Single Stations and AS Redundancy Stations) can be networked simply and effectively with ET 200M remote I/O stations over PROFINET IO. If a PN/IE interface is integrated in the CPU of the automation system (AS 414-3IE, AS 416-3IE, and all H/F/FH systems), then it is to be used for connecting ET 200M remote I/O stations via PROFINET IO. In standard automation systems, the PN/IE interfaces of type CP 443-1 communication modules can also be used for PROFINET IO.

The maximum availability with minimum error handling times is achieved by the AS Redundancy Station (2 H/FH systems) in conjunction with the system redundancy of the I/O devices. System redundancy refers to a type of PROFINET IO communication where each I/O device establishes a communication connection to each of the two CPUs of an AS Redundancy Station over the topological network.

Runtime licenses

Each automation system is shipped with the SIMATIC PCS 7 AS Runtime License for 100 process objects (POs). Safety-related automation systems are additionally shipped with the SIMATIC S7 F Systems RT License. The 100 POs of the SIMATIC PCS 7 AS Runtime license can be expanded by additional Runtime licenses for 100, 1 000 or 10 000 POs. The process objects of additional Runtime licenses can be added to process objects which already exist. The number and type (e.g. 100 or 1000) of additional Runtime licenses are irrelevant.

Individual configuration of AS bundles

The various versions of the SIMATIC PCS 7 automation systems AS 412 to AS 417 are available as AS bundles as follows:

- Individual components, combined per station in one consignment
- Preassembled and tested complete systems (no extra charge compared to delivery of individual components)

Typical combinations can be selected from tables in the section "Selection and ordering data".

The complete range is available to you via two configurators in the Industry Mall:

- SIMATIC PCS 7 AS Single Station configurator
- SIMATIC PCS 7 AS Redundancy Station configurator

Ordering information

- For a redundancy configuration based on 2 AS Single Stations, 4 sync modules (up to 10 m or 10 km) and 2 FO sync cables are additionally required. The selection depends on the distance between the two AS single stations.
- FO sync cables longer than 1 m must always be ordered separately (2 cables required in each case).

SIMATIC PCS 7 system hardware

Automation systems

Complementary S7-400 systems

Accessories

Backup batteries

Lithium backup batteries of type AA with 2.3 Ah are used in the power supply modules of all SIMATIC PCS 7 automation systems AS 412 to AS 417. Since lithium batteries are easily inflammable, more rigorous transport and storage regulations apply to them.

To avoid subjecting the AS bundles to these more rigorous transport and storage regulations, the backup batteries must be ordered and delivered separately (Article No. 6ES7971-0BA00).

The following backup batteries are required depending on the configuration of the AS bundles:

- SIMATIC PCS 7 AS Single Station:
 - With 1 power supply module: 2 units
 - With 2 redundant power supply modules: 4 units
- SIMATIC PCS 7 AS Redundancy Station:
 - With 2 power supply modules: 4 units
 - With 2 x 2 redundant power supply modules: 8 units

Ordering data**Configuration tables for standard automation systems**

	Article No.					
AS 414-3 with SIMATIC PCS 7 AS Runtime license for 100 POs CPU with 3 interfaces (MPI/DP and slot for IF module) 4 MB RAM (2 MB each for program and data)	6ES7654- - - - - - G					
Type of delivery • Individual components, not pre-assembled • Pre-assembled and tested	7 8					
Memory card • Memory card 2 MB RAM (up to approx. 100 POs) • Memory card 4 MB RAM (up to approx. 210 POs) • Memory card 8 MB RAM (up to approx. 800 POs)	B C D					
CPU type • CPU 414-3 (up to approx. 450 POs)	C					
Additive IF 964-DP interface module • Without additive IF 964-DP • 1 x IF 964-DP	0 1					
Interface to Industrial Ethernet/PROFINET plant bus • 1 x CP 443-1EX30 • 2 x CP 443-1EX30	3 4					
Racks • UR2 (9 slots), aluminum • UR2 (9 slots), steel • UR1 (18 slots), aluminum • UR1 (18 slots), steel	3 4 5 6					
Power supply (without backup batteries) • 1 x PS 407, 10 A for 120/230 V UC • 1 x PS 407, 10 A for 120/230 V UC, optional redundancy • 1 x PS 407, 20 A for 120/230 V UC • 2 x PS 407, 10 A for 120/230 V AC/DC, optional redundancy • 1 x PS 405, 10 A for 24 V DC • 1 x PS 405, 10 A for 24 V DC, optional redundancy • 1 x PS 405, 20 A for 24 V DC • 2 x PS 405, 10 A for 24 V DC, optional redundancy	B C D E G H J K					
Additive PROFIBUS DP interfaces • Without CP 443-5 Extended • 1 x CP 443-5 Extended • 2 x CP 443-5 Extended • 3 x CP 443-5 Extended ¹⁾ • 4 x CP 443-5 Extended ¹⁾	0 1 2 3 4					
AS 416-2 with SIMATIC PCS 7 AS Runtime license for 100 POs CPU with 2 interfaces (MPI/DP and DP) 8 MB RAM (4 MB each for program and data)	6ES7654- - - - - - G					
Type of delivery • Individual components, not pre-assembled • Pre-assembled and tested	7 8					
Memory card • Memory card 4 MB RAM (up to approx. 210 POs) • Memory card 8 MB RAM (up to approx. 800 POs) • Memory card 16 MB RAM (up to approx. 3 000 POs)	C D E					
CPU type • CPU 416-2 (up to approx. 900 POs)	G					
Additive IF 964-DP interface module • Without additive IF 964-DP	0					
Interface to Industrial Ethernet/PROFINET plant bus • 1 x CP 443-1EX30 • 2 x CP 443-1EX30	3 4					
Racks • UR2 (9 slots), aluminum • UR2 (9 slots), steel • UR1 (18 slots), aluminum • UR1 (18 slots), steel	3 4 5 6					
Power supply (without backup batteries) • 1 x PS 407, 10 A for 120/230 V UC • 1 x PS 407, 10 A for 120/230 V UC, optional redundancy • 1 x PS 407, 20 A for 120/230 V UC • 2 x PS 407, 10 A for 120/230 V AC/DC, optional redundancy • 1 x PS 405, 10 A for 24 V DC • 1 x PS 405, 10 A for 24 V DC, optional redundancy • 1 x PS 405, 20 A for 24 V DC • 2 x PS 405, 10 A for 24 V DC, optional redundancy	B C D E G H J K					
Additive PROFIBUS DP interfaces • Without CP 443-5 Extended • 1 x CP 443-5 Extended • 2 x CP 443-5 Extended • 3 x CP 443-5 Extended • 4 x CP 443-5 Extended ¹⁾	0 1 2 3 4					

¹⁾ With the UR2 rack in combination with a redundant power supply, the number of additive CP 443-5 Extended is limited to 2.

¹⁾ With the UR2 rack in combination with a redundant power supply, the number of additive CP 443-5 Extended is limited to 3.

SIMATIC PCS 7 system hardware

Automation systems

Complementary S7-400 systems

Standard automation systems**Ordering data** (continued)

	Article No.						
	6	E	S	7	6	5	4
AS 416-3 with SIMATIC PCS 7 AS Runtime license for 100 POs CPU with 3 interfaces (MPI/DP, DP and slot for IF module) 16 MB RAM (8 MB each for program and data)							G
Type of delivery • Individual components, not pre-assembled • Pre-assembled and tested							7 8
Memory card • Memory card 4 MB RAM (up to approx. 210 POs) • Memory card 8 MB RAM (up to approx. 800 POs) • Memory card 16 MB RAM (up to approx. 2 100 POs)		C					D E
CPU type • CPU 416-3 (up to approx. 1 500 POs)							H
Additive IF 964-DP interface module • Without additive IF 964-DP • 1 x IF 964-DP							0 1
Interface to Industrial Ethernet/PROFINET plant bus • 1 x CP 443-1EX30 • 2 x CP 443-1EX30							3 4
Racks • UR2 (9 slots), aluminum • UR2 (9 slots), steel • UR1 (18 slots), aluminum • UR1 (18 slots), steel							3 4 5 6
Power supply (without backup batteries) • 1 x PS 407, 10 A for 120/230 V UC • 1 x PS 407, 10 A for 120/230 V UC, optional redundancy • 1 x PS 407, 20 A for 120/230 V UC • 2 x PS 407, 10 A for 120/230 V AC/DC, optional redundancy • 1 x PS 405, 10 A for 24 V DC • 1 x PS 405, 10 A for 24 V DC, optional redundancy • 1 x PS 405, 20 A for 24 V DC • 2 x PS 405, 10 A for 24 V DC, optional redundancy							B C D E G H J K
Additive PROFIBUS DP interfaces • Without CP 443-5 Extended • 1 x CP 443-5 Extended • 2 x CP 443-5 Extended • 3 x CP 443-5 Extended ¹⁾ • 4 x CP 443-5 Extended ¹⁾							0 1 2 3 4

¹⁾ With the UR2 rack in combination with a redundant power supply, the number of additive CP 443-5 Extended is limited to 2.

	Article No.						
	6	E	S	7	6	5	4
AS 417-4 with SIMATIC PCS 7 AS Runtime license for 100 POs CPU with 4 interfaces (MPI/DP, DP and 2 slots for IF modules) 30 MB RAM (15 MB each for program and data)							G
Type of delivery • Individual components, not pre-assembled • Pre-assembled and tested							7 8
Memory card • Memory card 8 MB RAM (up to approx. 800 POs) • Memory card 16 MB RAM (up to approx. 2 100 POs) • Memory card 64 MB RAM (> 2 100 POs)		D					E G
CPU type • CPU 417-4 (up to approx. 2 200 POs)							K
Additive IF 964-DP interface module • Without additive IF 964-DP • 1 x IF 964-DP • 2 x IF 964-DP							0 1 2
Interface to Industrial Ethernet/PROFINET plant bus • 1 x CP 443-1EX30 • 2 x CP 443-1EX30							3 4
Racks • UR2 (9 slots), aluminum • UR2 (9 slots), steel • UR1 (18 slots), aluminum • UR1 (18 slots), steel							3 4 5 6
Power supply (without backup batteries) • 1 x PS 407, 10 A for 120/230 V UC • 1 x PS 407, 10 A for 120/230 V UC, optional redundancy • 1 x PS 407, 20 A for 120/230 V UC • 2 x PS 407, 10 A for 120/230 V AC/DC, optional redundancy • 1 x PS 405, 10 A for 24 V DC • 1 x PS 405, 10 A for 24 V DC, optional redundancy • 1 x PS 405, 20 A for 24 V DC • 2 x PS 405, 10 A for 24 V DC, optional redundancy							B C D E G H J K
Additive PROFIBUS DP interfaces • Without CP 443-5 Extended • 1 x CP 443-5 Extended • 2 x CP 443-5 Extended • 3 x CP 443-5 Extended ¹⁾ • 4 x CP 443-5 Extended ¹⁾							0 1 2 3 4

¹⁾ With the UR2 rack in combination with a redundant power supply, the number of additive CP 443-5 Extended is limited to 2.

Ordering data (continued)

	Article No.						
AS 414-3IE with SIMATIC PCS 7 AS Runtime license for 100 POs CPU with 2 DP interfaces (MPI/DP and slot for IF module) 4 MB RAM (2 MB each for program and data)	6ES7654-						
							G
Type of delivery • Individual components, not pre-assembled • Pre-assembled and tested	7						
	8						
Memory card • Memory card 2 MB RAM (up to approx. 100 POs) • Memory card 4 MB RAM (up to approx. 210 POs) • Memory card 8 MB RAM (up to approx. 800 POs)		B					
		C					
		D					
CPU type • CPU 414-3 PN/DP (up to approx. 450 POs)			D				
Additive IF 964-DP interface module • Without additive IF 964-DP • 1 × IF 964-DP				0			
				1			
Interface to Industrial Ethernet/PROFINET plant bus • Integrated, without CP 443-1 • 1 × CP 443-1EX30 • 2 × CP 443-1EX30					0		
					3		
					4		
Racks • UR2 (9 slots), aluminum • UR2 (9 slots), steel • UR1 (18 slots), aluminum • UR1 (18 slots), steel						3	
						4	
						5	
						6	
Power supply (without backup batteries) • 1 × PS 407, 10 A for 120/230 V UC • 1 × PS 407, 10 A for 120/230 V UC, optional redundancy • 1 × PS 407, 20 A for 120/230 V UC • 2 × PS 407, 10 A for 120/230 V AC/DC, optional redundancy • 1 × PS 405, 10 A for 24 V DC • 1 × PS 405, 10 A for 24 V DC, optional redundancy • 1 × PS 405, 20 A for 24 V DC • 2 × PS 405, 10 A for 24 V DC, optional redundancy							B
							C
							D
							E
							G
							H
							J
							K
Additive PROFIBUS DP interfaces • Without CP 443-5 Extended • 1 × CP 443-5 Extended • 2 × CP 443-5 Extended • 3 × CP 443-5 Extended • 4 × CP 443-5 Extended ¹⁾							0
							1
							2
							3
							4

¹⁾ With the UR2 rack in combination with a redundant power supply, the number of additive CP 443-5 Extended is limited to 3.

	Article No.						
AS 416-3IE with SIMATIC PCS 7 AS Runtime license for 100 POs CPU with 2 DP interfaces (MPI/DP and slot for IF module) 16 MB RAM (8 MB each for program and data)	6ES7654-						
							G
Type of delivery • Individual components, not pre-assembled • Pre-assembled and tested	7						
	8						
Memory card • Memory card 4 MB RAM (up to approx. 210 POs) • Memory card 8 MB RAM (up to approx. 800 POs) • Memory card 16 MB RAM (up to approx. 2 100 POs)							C
							D
							E
CPU type • CPU 416-3 PN/DP (up to approx. 1 500 POs)							J
Additive IF 964-DP interface module • Without additive IF 964-DP • 1 × IF 964-DP						0	
						1	
Interface to Industrial Ethernet/PROFINET plant bus • Integrated, without CP 443-1 • 1 × CP 443-1EX30 • 2 × CP 443-1EX30							0
							3
							4
Racks • UR2 (9 slots), aluminum • UR2 (9 slots), steel • UR1 (18 slots), aluminum • UR1 (18 slots), steel							3
							4
							5
							6
Power supply (without backup batteries) • 1 × PS 407, 10 A for 120/230 V UC • 1 × PS 407, 10 A for 120/230 V UC, optional redundancy • 1 × PS 407, 20 A for 120/230 V UC • 2 × PS 407, 10 A for 120/230 V AC/DC, optional redundancy • 1 × PS 405, 10 A for 24 V DC • 1 × PS 405, 10 A for 24 V DC, optional redundancy • 1 × PS 405, 20 A for 24 V DC • 2 × PS 405, 10 A for 24 V DC, optional redundancy							B
							C
							D
							E
							G
							H
							J
							K
Additive PROFIBUS DP interfaces • Without CP 443-5 Extended • 1 × CP 443-5 Extended • 2 × CP 443-5 Extended • 3 × CP 443-5 Extended • 4 × CP 443-5 Extended ¹⁾							0
							1
							2
							3
							4

¹⁾ With the UR2 rack in combination with a redundant power supply, the number of additive CP 443-5 Extended is limited to 3.

SIMATIC PCS 7 system hardware

Automation systems

Complementary S7-400 systems

Standard automation systems

Ordering data

Article No.

Article No.

Individual components of standard automation systems

CPU 414-3 RAM 4 MB (2 MB each for program and data); module occupies 2 slots	6ES7414-3XM07-0AB0	PS 407 power supply module; 10 A 120/230 V UC; 5 V DC/10 A, 24 V DC/1 A; with battery compartment for 2 backup batteries, module occupies 2 slots	6ES7407-0KA02-0AA0
CPU 416-2 RAM 8 MB (4 MB each for program and data); module occupies 1 slot	6ES7416-2XP07-0AB0	PS 407 power supply module; 10 A, optional redundancy 120/230 V UC; 5 V DC/10 A, 24 V DC/1 A; with battery compartment for 2 backup batteries, module occupies 2 slots	6ES7407-0KR02-0AA0
CPU 416-3 RAM 16 MB (8 MB each for program and data); module occupies 2 slots	6ES7416-3XS07-0AB0	PS 407 power supply module; 20 A 120/230 V UC; 5 V DC/20 A, 24 V DC/1 A; with battery compartment for 2 backup batteries, module occupies 2 slots	6ES7407-0RA02-0AA0
CPU 417-4 32 MB RAM integrated (16 MB each for program and data); module occupies 2 slots	6ES7417-4XT07-0AB0	PS 405 power supply module; 10 A 24 V DC; 5 V DC/10 A, 24 V DC/1 A; with battery compartment for 2 backup batteries, module occupies 2 slots	6ES7405-0KA02-0AA0
CPU 414-3 PN/DP RAM 4 MB (2 MB each for program and data); module occupies 2 slots	6ES7414-3EM07-0AB0	PS 405 power supply module; 10 A, optional redundancy 24 V DC; 5 V DC/10 A, 24 V DC/1 A; with battery compartment for 2 backup batteries, module occupies 2 slots	6ES7405-0KR02-0AA0
CPU 416-3 PN/DP RAM 16 MB (8 MB each for program and data); module occupies 2 slots	6ES7416-3ES07-0AB0	PS 405 power supply module; 20 A 24 V DC; 5 V DC/20 A, 24 V DC/1 A; with battery compartment for 2 backup batteries, module occupies 2 slots	6ES7405-0RA02-0AA0
Memory card RAM • 2 MB • 4 MB • 8 MB • 16 MB • 64 MB	6ES7952-1AL00-0AA0 6ES7952-1AM00-0AA0 6ES7952-1AP00-0AA0 6ES7952-1AS00-0AA0 6ES7952-1AY00-0AA0	Backup battery Type AA, 2.3 Ah	6ES7971-0BA00
Memory Card Flash EPROM Only required to update firmware • 16 MB	6ES7952-1KS00-0AA0	Aluminum UR1 rack 18 slots	6ES7400-1TA11-0AA0
CP 443-1 Communication module for connecting SIMATIC S7-400 to Industrial Ethernet via TCP/IP, ISO and UDP; PROFINET IO controller, MRP; integrated real-time switch ERTEC with two ports; 2 x RJ45 interface; S7 communication, open communication (SEND/RECEIVE) with FETCH/WRITE, with or without RFC 1006, DHCP, SNMP V2, diagnostics, multicast, access protection via IP access list, initialization via LAN 10/100 Mbps; with electronic manual on DVD	6GK7443-1EX30-0XE0	Aluminum UR2 rack 9 slots	6ES7400-1JA11-0AA0
CP 443-5 Extended Communication module for connection of SIMATIC S7-400 to PROFIBUS as DP master or for S7 communication, for increasing the number of DP lines, for data set routing with SIMATIC PDM and for 10-ms time stamping, electronic manual on CD; module occupies 1 slot	6GK7443-5DX05-0XE0	Steel UR1 rack 18 slots	6ES7400-1TA01-0AA0
IF 964-DP Interface module for connection of another PROFIBUS DP line, for plugging into a free DP module slot of the CPU	6ES7964-2AA04-0AB0	Steel UR2 rack 9 slots	6ES7400-1JA01-0AA0
		Runtime licenses for SIMATIC PCS 7 automation systems (can be added to existing licenses)	
		SIMATIC PCS 7 AS Runtime license Language-neutral, floating license for 1 user Without SIMATIC PCS 7 Software Media Package • Goods delivery License key on USB flash drive, Certificate of License - 100 POs - 1 000 POs - 10 000 POs • Online delivery License key download, online Certificate of License Note: Email address required! - 100 POs - 1 000 POs - 10 000 POs	6ES7653-2BA00-0XB5 6ES7653-2BB00-0XB5 6ES7653-2BC00-0XB5 6ES7653-2BA00-0XH5 6ES7653-2BB00-0XH5 6ES7653-2BC00-0XH5

Ordering data
Configuration tables for high availability automation systems

	Article No.						
AS 412-5-1H (Single Station) with SIMATIC PCS 7 AS Runtime license for 100 POs CPU with 2 PROFIBUS interfaces (MPI/DP master and DP master) and 1 PN/IE interface (2 port switch) 1 MB RAM (512 KB each for program and data)	6ES7654-						
							G
Type of delivery • Individual components, not pre-assembled • Pre-assembled and tested	7						
	8						
Memory card • Memory card 1 MB RAM (up to approx. 30 POs) • Memory card 2 MB RAM (up to approx. 100 POs)		A					
		B					
CPU type • CPU 412-5H (up to approx. 30 POs)			A				
Additive IF 964-DP interface module • Without additive IF 964-DP				0			
Interface to Industrial Ethernet plant bus • Without interface module • 1 × CP 443-1EX30 ¹⁾ • 2 × CP 443-1EX30 for redundant interface ¹⁾				0			
				3			
				4			
Racks • UR2 (9 slots), aluminum • UR2 (9 slots), steel • UR1 (18 slots), aluminum • UR1 (18 slots), steel					3		
					4		
					5		
					6		
Power supply (without backup batteries) • 1 × PS 407, 10 A for 120/230 V AC/DC • 1 × PS 407, 10 A for 120/230 V AC/DC, optional redundancy • 1 × PS 407, 20 A for 120/230 V AC/DC • 2 × PS 407, 10 A for 120/230 V AC/DC (redundant) • 1 × PS 405, 10 A for 24 V DC • 1 × PS 405, 10 A for 24 V DC, optional redundancy • 1 × PS 405, 20 A for 24 V DC • 2 × PS 405, 10 A for 24 V DC (redundant)						B	
						C	
						D	
						E	
						G	
						H	
						J	
						K	
Additive PROFIBUS DP interfaces • Without CP 443-5 Extended • 1 × CP 443-5 Extended • 2 × CP 443-5 Extended ¹⁾ • 3 × CP 443-5 Extended ¹⁾ • 4 × CP 443-5 Extended ¹⁾							0
							1
							2
							3
							4

¹⁾ Up to 5 CPs can be plugged into the UR2 rack with a single power supply or up to 3 with a redundant power supply.

	Article No.						
AS 414-5-1H (Single Station) with SIMATIC PCS 7 AS Runtime license for 100 POs CPU with 2 PROFIBUS interfaces (MPI/DP master and DP master) and 1 PN/IE interface (2 port switch) 4 MB RAM (2 MB each for program and data)	6ES7654-						
							G
Type of delivery • Individual components, not pre-assembled • Pre-assembled and tested	7						
	8						
Memory card • Memory card 2 MB RAM (up to approx. 100 POs) • Memory card 4 MB RAM (up to approx. 210 POs)		B					
		C					
CPU type • CPU 414-5H (up to approx. 350 POs)			E				
Additive IF 964-DP interface modules • Without additive IF 964-DP				0			
Interface to Industrial Ethernet plant bus • Without interface module • 1 × CP 443-1EX30 ¹⁾ • 2 × CP 443-1EX30 for redundant interface ¹⁾				0			
				3			
				4			
Racks • UR2 (9 slots), aluminum • UR2 (9 slots), steel • UR1 (18 slots), aluminum • UR1 (18 slots), steel						3	
						4	
						5	
						6	
Power supply (without backup batteries) • 1 × PS 407, 10 A for 120/230 V AC/DC • 1 × PS 407, 10 A for 120/230 V AC/DC, optional redundancy • 1 × PS 407, 20 A for 120/230 V AC/DC • 2 × PS 407, 10 A for 120/230 V AC/DC (redundant) • 1 × PS 405, 10 A for 24 V DC • 1 × PS 405, 10 A for 24 V DC, optional redundancy • 1 × PS 405, 20 A for 24 V DC • 2 × PS 405, 10 A for 24 V DC (redundant)							B
							C
							D
							E
							G
							H
							J
							K
Additive PROFIBUS DP interfaces • Without CP 443-5 Extended • 1 × CP 443-5 Extended • 2 × CP 443-5 Extended ¹⁾ • 3 × CP 443-5 Extended ¹⁾ • 4 × CP 443-5 Extended ¹⁾							0
							1
							2
							3
							4

¹⁾ Up to 5 CPs can be plugged into the UR2 rack with a single power supply or up to 3 with a redundant power supply.

SIMATIC PCS 7 system hardware

Automation systems

Complementary S7-400 systems

High-availability automation systems

Ordering data (continued)

	Article No.						
AS 416-5-1H (Single Station) with SIMATIC PCS 7 AS Runtime license for 100 POs CPU with 2 PROFIBUS interfaces (MPI/DP master and DP master) and 1 PN/IE interface (2 port switch) 16 MB RAM (6 MB for program and 10 MB for data)	6ES7654-						
							G
Type of delivery • Individual components, not pre-assembled • Pre-assembled and tested	7 8						
Memory card • Memory card 4 MB RAM (up to approx. 210 POs) • Memory card 8 MB RAM (up to approx. 800 POs) • Memory card 16 MB RAM (up to approx. 2 100 POs)	C D E						
CPU type • CPU 416-5H (up to approx. 1 200 POs)	P						
Additive IF 964-DP interface modules • Without additive IF 964-DP		0					
Interface to Industrial Ethernet plant bus • Without interface module • 1 × CP 443-1EX30 ¹⁾ • 2 × CP 443-1EX30 for redundant interface ¹⁾			0 3 4				
Racks • UR2 (9 slots), aluminum • UR2 (9 slots), steel • UR1 (18 slots), aluminum • UR1 (18 slots), steel				3 4 5 6			
Power supply (without backup batteries) • 1 × PS 407, 10 A for 120/230 V AC/DC • 1 × PS 407, 10 A for 120/230 V AC/DC, optional redundancy • 1 × PS 407, 20 A for 120/230 V AC/DC • 2 × PS 407, 10 A for 120/230 V AC/DC (redundant) • 1 × PS 405, 10 A for 24 V DC • 1 × PS 405, 10 A for 24 V DC, optional redundancy • 1 × PS 405, 20 A for 24 V DC • 2 × PS 405, 10 A for 24 V DC (redundant)					B C D E G H J K		
Additive PROFIBUS DP interfaces • Without CP 443-5 Extended • 1 × CP 443-5 Extended • 2 × CP 443-5 Extended ¹⁾ • 3 × CP 443-5 Extended ¹⁾ • 4 × CP 443-5 Extended ¹⁾						0 1 2 3 4	

¹⁾ Up to 5 CPs can be plugged into the UR2 rack with a single power supply or up to 3 with a redundant power supply.

	Article No.						
AS 417-5-1H (Single Station) with SIMATIC PCS 7 AS Runtime license for 100 POs CPU with 2 PROFIBUS interfaces (MPI/DP master and DP master) and 1 PN/IE interface (2 port switch) 32 MB RAM (16 MB each for program and data)	6ES7654-						
							G
Type of delivery • Individual components, not pre-assembled • Pre-assembled and tested	7 8						
Memory card • Memory card 4 MB RAM (up to approx. 210 POs) • Memory card 8 MB RAM (up to approx. 800 POs) • Memory card 16 MB RAM (up to approx. 2 100 POs) • Memory card 64 MB RAM	C D E G						
CPU type • CPU 417-5H (up to approx. 2 000 POs)	M						
Additive IF 964-DP interface modules • Without additive IF 964-DP		0					
Interface to Industrial Ethernet plant bus • Without interface module • 1 × CP 443-1EX30 ¹⁾ • 2 × CP 443-1EX30 for redundant interface ¹⁾			0 3 4				
Racks • UR2 (9 slots), aluminum • UR2 (9 slots), steel • UR1 (18 slots), aluminum • UR1 (18 slots), steel					3 4 5 6		
Power supply (without backup batteries) • 1 × PS 407, 10 A for 120/230 V AC/DC • 1 × PS 407, 10 A for 120/230 V AC/DC, optional redundancy • 1 × PS 407, 20 A for 120/230 V AC/DC • 2 × PS 407, 10 A for 120/230 V AC/DC (redundant) • 1 × PS 405, 10 A for 24 V DC • 1 × PS 405, 10 A for 24 V DC, optional redundancy • 1 × PS 405, 20 A for 24 V DC • 2 × PS 405, 10 A for 24 V DC (redundant)						B C D E G H J K	
Additive PROFIBUS DP interfaces • Without CP 443-5 Extended • 1 × CP 443-5 Extended • 2 × CP 443-5 Extended ¹⁾ • 3 × CP 443-5 Extended ¹⁾ • 4 × CP 443-5 Extended ¹⁾						0 1 2 3 4	

¹⁾ Up to 5 CPs can be plugged into the UR2 rack with a single power supply or up to 3 with a redundant power supply.

Ordering data (continued)

	Article No.						
AS 412-5-2H (Redundancy Station) with SIMATIC PCS 7 AS Runtime license for 100 POs 2 × CPU each with 2 PROFIBUS interfaces (MPI/DP master and DP master) and 1 PN/IE interface (2-port switch) 2 × 1 MB RAM (512 KB each for program and data)	6ES7656-						
Type of delivery							
• Individual components, not pre-assembled	7						
• Pre-assembled and tested	8						
Memory card							
• 2 × Memory Card 1 MB RAM (up to approx. 30 POs)	A						
• 2 × Memory Card 2 MB RAM (up to approx. 100 POs)	B						
CPU type							
• 2 × CPU 412-5H (up to approx. 30 POs)	A						
Sync modules and cables							
• 2 × 2 sync modules for distances up to 10 m and 2 × FO sync cable, 1 m		3					
Interface to Industrial Ethernet plant bus							
• Without interface module			0				
• 2 × CP 443-1EX30 for redundant interface ¹⁾			3				
• 2 × 2 CP 443-1EX30 for 4-way connection ¹⁾			4				
Racks							
• 1 × UR2-H (2 × 9 slots), aluminum				1			
• 1 × UR2-H (2 × 9 slots), steel				2			
• 2 × UR2 (9 slots), aluminum				3			
• 2 × UR2 (9 slots), steel				4			
Power supply (without backup batteries)							
• 2 × PS 407, 10 A for 120/230 V AC/DC					B		
• 2 × PS 407, 10 A for 120/230 V AC/DC, optional redundancy					C		
• 2 × PS 407, 20 A for 120/230 V AC/DC					D		
• 2 × 2 PS 407, 10 A for 120/230 V AC/DC (redundant)					E		
• 2 × PS 405, 10 A for 24 V DC					G		
• 2 × PS 405, 10 A for 24 V DC, optional redundancy					H		
• 2 × PS 405, 20 A for 24 V DC					J		
• 2 × 2 PS 405, 10 A for 24 V DC (redundant)					K		
Additive PROFIBUS DP interfaces							
• Without CP 443-5 Extended						0	
• 2 × CP 443-5 Extended						1	
• 2 × 2 CP 443-5 Extended ¹⁾						2	
• 2 × 3 CP 443-5 Extended ¹⁾						3	
• 2 × 4 CP 443-5 Extended ¹⁾						4	

¹⁾ Up to 5 CPs can be plugged in per subsystem with a single power supply or up to 3 with a redundant power supply.

	Article No.						
AS 414-5-2H (Redundancy Station) with SIMATIC PCS 7 AS Runtime license for 100 POs 2 × CPU each with 2 PROFIBUS interfaces (MPI/DP master and DP master) and 1 PN/IE interface (2-port switch) 2 × 4 MB RAM (2 MB each for program and data)	6ES7656-						
Type of delivery							
• Individual components, not pre-assembled	7						
• Pre-assembled and tested	8						
Memory card							
• 2 × Memory Card 2 MB RAM (up to approx. 100 POs)	B						
• 2 × Memory Card 4 MB RAM (up to approx. 210 POs)	C						
CPU type							
• 2 × CPU 414-5H (up to approx. 350 POs)	E						
Sync modules and cables							
• 2 × 2 sync modules for distances up to 10 m and 2 × FO sync cable, 1 m		3					
• 2 × 2 sync modules for up to 10 km and 2 × FO sync cable, 1 m, for testing		4					
Interface to Industrial Ethernet plant bus							
• Without interface module					0		
• 2 × CP 443-1EX30 for redundant interface ¹⁾					3		
• 2 × 2 CP 443-1EX30 for 4-way connection ¹⁾					4		
Racks							
• 1 × UR2-H (2 × 9 slots), aluminum						1	
• 1 × UR2-H (2 × 9 slots), steel						2	
• 2 × UR2 (9 slots), aluminum						3	
• 2 × UR2 (9 slots), steel						4	
Power supply (without backup batteries)							
• 2 × PS 407, 10 A for 120/230 V AC/DC						B	
• 2 × PS 407, 10 A for 120/230 V AC/DC, optional redundancy						C	
• 2 × PS 407, 20 A for 120/230 V AC/DC						D	
• 2 × 2 PS 407, 10 A for 120/230 V AC/DC (redundant)						E	
• 2 × PS 405, 10 A for 24 V DC						G	
• 2 × PS 405, 10 A for 24 V DC, optional redundancy						H	
• 2 × PS 405, 20 A for 24 V DC						J	
• 2 × 2 PS 405, 10 A for 24 V DC (redundant)						K	
Additive PROFIBUS DP interfaces							
• Without CP 443-5 Extended						0	
• 2 × CP 443-5 Extended						1	
• 2 × 2 CP 443-5 Extended ¹⁾						2	
• 2 × 3 CP 443-5 Extended ¹⁾						3	
• 2 × 4 CP 443-5 Extended ¹⁾						4	

¹⁾ Up to 5 CPs can be plugged in per subsystem with a single power supply or up to 3 with a redundant power supply.

SIMATIC PCS 7 system hardware

Automation systems

Complementary S7-400 systems

High-availability automation systems

Ordering data (continued)

	Article No.						
	6	E	S	7	6	5	6
AS 416-5-2H (Redundancy Station) with SIMATIC PCS 7 AS Runtime license for 100 POs 2 × CPU each with 2 PROFIBUS interfaces (MPI/DP master and DP master) and 1 PN/IE interface (2-port switch) 2 × 16 MB RAM (6 MB each for program and 10 MB each for data)							
Type of delivery • Individual components, not pre-assembled • Pre-assembled and tested	7						F
	8						
Memory card • 2 × Memory Card 4 MB RAM (up to approx. 210 POs) • 2 × Memory Card 8 MB RAM (up to approx. 800 POs) • 2 × Memory Card 16 MB RAM (up to approx. 2 100 POs)		C					
		D					
		E					
CPU type • 2 × CPU 416-5H (up to approx. 1 200 POs)			P				
Sync modules and cables • 2 × 2 sync modules for distances up to 10 m and 2 × FO sync cable, 1 m • 2 × 2 sync modules for up to 10 km and 2 × FO sync cable, 1 m, for testing			3				
			4				
Interface to Industrial Ethernet plant bus • Without interface module • 2 × CP 443-1EX30 for redundant interface ¹⁾ • 2 × 2 CP 443-1EX30 for 4-way connection ¹⁾				0			
				3			
				4			
Racks • 1 × UR2-H (2 × 9 slots), aluminum • 1 × UR2-H (2 × 9 slots), steel • 2 × UR2 (9 slots), aluminum • 2 × UR2 (9 slots), steel					1		
					2		
					3		
					4		
Power supply (without backup batteries) • 2 × PS 407, 10 A for 120/230 V AC/DC • 2 × PS 407, 10 A for 120/230 V AC/DC, optional redundancy • 2 × PS 407, 20 A for 120/230 V AC/DC • 2 × 2 PS 407, 10 A for 120/230 V AC/DC (redundant) • 2 × PS 405, 10 A for 24 V DC • 2 × PS 405, 10 A for 24 V DC, optional redundancy • 2 × PS 405, 20 A for 24 V DC • 2 × 2 PS 405, 10 A for 24 V DC (redundant)							B
							C
							D
							E
							G
							H
							J
							K
Additive PROFIBUS DP interfaces • Without CP 443-5 Extended • 2 × CP 443-5 Extended • 2 × 2 CP 443-5 Extended ¹⁾ • 2 × 3 CP 443-5 Extended ¹⁾ • 2 × 4 CP 443-5 Extended ¹⁾							0
							1
							2
							3
							4

¹⁾ Up to 5 CPs can be plugged in per subsystem with a single power supply or up to 3 with a redundant power supply.

	Article No.						
	6	E	S	7	6	5	6
AS 417-5-2H (Redundancy Station) with SIMATIC PCS 7 AS Runtime license for 100 POs 2 × CPU each with 2 PROFIBUS interfaces (MPI/DP master and DP master) and 1 PN/IE interface (2-port switch) 2 × 32 MB RAM (16 MB each for program and data)							
Type of delivery • Individual components, not pre-assembled • Pre-assembled and tested	7						F
	8						
Memory card • 2 × Memory Card 4 MB RAM (up to approx. 210 POs) • 2 × Memory Card 8 MB RAM (up to approx. 800 POs) • 2 × Memory Card 16 MB RAM (up to approx. 2 100 POs)		C					
		D					
		E					
CPU type • 2 × CPU 417-5H (up to approx. 2 000 POs)				M			
Sync modules and cables • 2 × 2 sync modules for distances up to 10 m and 2 × FO sync cable, 1 m • 2 × 2 sync modules for up to 10 km and 2 × FO sync cable, 1 m, for testing					3		
					4		
Interface to Industrial Ethernet plant bus • Without interface module • 2 × CP 443-1EX30 for redundant interface ¹⁾ • 2 × 2 CP 443-1EX30 for 4-way connection ¹⁾						0	
						3	
						4	
Racks • 1 × UR2-H (2 × 9 slots), aluminum • 1 × UR2-H (2 × 9 slots), steel • 2 × UR2 (9 slots), aluminum • 2 × UR2 (9 slots), steel							1
							2
							3
							4
Power supply (without backup batteries) • 2 × PS 407, 10 A for 120/230 V AC/DC • 2 × PS 407, 10 A for 120/230 V AC/DC, optional redundancy • 2 × PS 407, 20 A for 120/230 V AC/DC • 2 × 2 PS 407, 10 A for 120/230 V AC/DC (redundant) • 2 × PS 405, 10 A for 24 V DC • 2 × PS 405, 10 A for 24 V DC, optional redundancy • 2 × PS 405, 20 A for 24 V DC • 2 × 2 PS 405, 10 A for 24 V DC (redundant)							B
							C
							D
							E
							G
							H
							J
							K
Additive PROFIBUS DP interfaces • Without CP 443-5 Extended • 2 × CP 443-5 Extended • 2 × 2 CP 443-5 Extended ¹⁾ • 2 × 3 CP 443-5 Extended ¹⁾ • 2 × 4 CP 443-5 Extended ¹⁾							0
							1
							2
							3
							4

¹⁾ Up to 5 CPs can be plugged in per subsystem with a single power supply or up to 3 with a redundant power supply.

Ordering data

Article No.

Article No.

Individual components of high availability automation systems

Ordering data	Article No.	Ordering data	Article No.
Individual components of the high availability SIMATIC PCS 7 automation systems		CP 443-5 Extended Communication module for connection of SIMATIC S7-400 to PROFIBUS as DP master or for S7 communication, for increasing the number of DP lines, for data set routing with SIMATIC PDM and for 10 ms time stamping, electronic manual on CD; module occupies 1 slot	6GK7443-5DX05-0XE0
CPU 412-5H PN/DP 1 MB RAM (512 KB each for program and data) Module occupies 2 slots	6ES7412-5HK06-0AB0	PS 407 power supply module; 10 A 120/230 V AC/DC; 5 V DC/10 A, 24 V DC/1 A; with battery compartment for 2 backup batteries, module occupies 2 slots	6ES7407-0KA02-0AA0
CPU 414-5H PN/DP 4 MB RAM (2 MB each for program and data) Module occupies 2 slots	6ES7414-5HM06-0AB0	PS 407 power supply module; 10 A, optional redundancy 120/230 V AC/DC; 5 V DC/10 A, 24 V DC/1 A; with battery compartment for 2 backup batteries, module occupies 2 slots	6ES7407-0KR02-0AA0
CPU 416-5H PN/DP 16 MB RAM (6 MB for program and 10 MB for data) Module occupies 2 slots	6ES7416-5HS06-0AB0	PS 407 power supply module; 20 A 120/230 V AC/DC; 5 V DC/20 A, 24 V DC/1 A; with battery compartment for 2 backup batteries, module occupies 2 slots	6ES7407-0RA02-0AA0
CPU 417-5H PN/DP 32 MB RAM (16 MB each for program and data) Module occupies 2 slots	6ES7417-5HT06-0AB0	PS 405 power supply module; 10 A 24 V DC; 5 V DC/10 A, 24 V DC/1 A; with battery compartment for 2 backup batteries, module occupies 2 slots	6ES7405-0KA02-0AA0
Sync set For linking the two redundant 412-5H, 414-5H, 416-5H or 417-5H CPUs; for distances up to <ul style="list-style-type: none"> • 10 m, consisting of 4 sync modules for up to 10 m and 2 FO sync cables, 1 m each • 10 km, consisting of 4 sync modules for up to 10 km Note: please order fiber-optic sync cables (2 units) in the required length separately. 	6ES7656-7XX30-0XE0 6ES7656-7XX40-0XE0	PS 405 power supply module; 10 A, optional redundancy 24 V DC; 5 V DC/10 A, 24 V DC/1 A; with battery compartment for 2 backup batteries, module occupies 2 slots	6ES7405-0KR02-0AA0
Sync module For linking the two 412-5H, 414-5H, 416-5H or 417-5H CPUs; 2 modules required per CPU For distances of up to <ul style="list-style-type: none"> • 10 m • 10 km 	6ES7960-1AA06-0XA0 6ES7960-1AB06-0XA0	PS 405 power supply module; 20 A 24 V DC; 5 V DC/20 A, 24 V DC/1 A; with battery compartment for 2 backup batteries, module occupies 2 slots	6ES7405-0RA02-0AA0
Sync cable (fiber-optic cable) For connecting the two 412-5H, 414-5H, 416-5H or 417-5H CPUs; each redundant automation system requires 2 cables <ul style="list-style-type: none"> • 1 m • 2 m • 10 m Other lengths	6ES7960-1AA04-5AA0 6ES7960-1AA04-5BA0 6ES7960-1AA04-5KA0 On request	Backup battery Type AA, 2.3 Ah	6ES7971-0BA00
Memory card RAM <ul style="list-style-type: none"> • 1 MB • 2 MB • 4 MB • 8 MB • 16 MB • 64 MB 	6ES7952-1AK00-0AA0 6ES7952-1AL00-0AA0 6ES7952-1AM00-0AA0 6ES7952-1AP00-0AA0 6ES7952-1AS00-0AA0 6ES7952-1AY00-0AA0	Aluminum UR1 rack 18 slots	6ES7400-1TA11-0AA0
Memory Card Flash-EPROM Only required to update firmware. Alternative: firmware update via the engineering system <ul style="list-style-type: none"> • 16 MB 	6ES7952-1KS00-0AA0	Aluminum UR2 rack 9 slots	6ES7400-1JA11-0AA0
CP 443-1 Communication module for connecting SIMATIC S7-400 to Industrial Ethernet via TCP/IP, ISO and UDP; PROFINET IO controller, MRP; integrated real-time switch ERTEC with two ports; 2 × RJ45 interface; S7 communication, open communication (SEND/RECEIVE) with FETCH/WRITE, with or without RFC 1006, DHCP, SNMP V2, diagnostics, multicast, access protection via IP access list, initialization via LAN 10/100 Mbit/s; with electronic manual on DVD	6GK7443-1EX30-0XE0	Aluminum UR2-H rack For divided central controllers; 2 × 9 slots	6ES7400-2JA10-0AA0
		Steel UR1 rack 18 slots	6ES7400-1TA01-0AA0
		Steel UR2 rack 9 slots	6ES7400-1JA01-0AA0
		Steel UR2-H rack For divided central controllers; 2 × 9 slots	6ES7400-2JA00-0AA0
		Runtime licenses for SIMATIC PCS 7 automation systems (can be added to existing licenses)	See "Individual components of standard automation systems"

SIMATIC PCS 7 system hardware

Automation systems

Complementary S7-400 systems

Safety-related automation systems

Ordering data

Configuration tables for safety-related automation systems

	Article No.						
AS 412F (Single Station) with SIMATIC PCS 7 AS Runtime license for 100 POs CPU with 2 PROFIBUS interfaces (MPI/DP master and DP master) and 1 PN/IE interface (2 port switch) 1 MB RAM (512 KB each for program and data)	6ES7654-						
Type of delivery • Individual components, not pre-assembled • Pre-assembled and tested	7						G
Memory card • Memory card 1 MB RAM (up to approx. 30 POs) • Memory card 2 MB RAM (up to approx. 100 POs)	A						
CPU type • CPU 412-5H with SIMATIC S7 F Systems RT license (up to approx. 30 POs)		B					
Additive interface modules • Without additive interface module			0				
Interface to Industrial Ethernet plant bus • Without interface module • 1 × CP 443-1EX30 ¹⁾ • 2 × CP 443-1EX30 for redundant interface ¹⁾			0	3	4		
Racks • UR2 (9 slots), aluminum • UR2 (9 slots), steel • UR1 (18 slots), aluminum • UR1 (18 slots), steel					3	4	5
							6
Power supply (without backup batteries) • 1 × PS 407, 10 A for 120/230 V UC • 1 × PS 407, 10 A for 120/230 V UC, optional redundancy • 1 × PS 407, 20 A for 120/230 V UC • 2 × PS 407, 10 A for 120/230 V AC/DC (redundant) • 1 × PS 405, 10 A for 24 V DC • 1 × PS 405, 10 A for 24 V DC, optional redundancy • 1 × PS 405, 20 A for 24 V DC • 2 × PS 405, 10 A for 24 V DC (redundant)							B
							C
							D
							E
							G
							H
							J
							K
Additive PROFIBUS DP interfaces • Without CP 443-5 Extended • 1 × CP 443-5 Extended • 2 × CP 443-5 Extended ¹⁾ • 3 × CP 443-5 Extended ¹⁾ • 4 × CP 443-5 Extended ¹⁾							0
							1
							2
							3
							4

¹⁾ Up to 5 CPs can be plugged into the UR2 rack with a single power supply or up to 3 with a redundant power supply.

	Article No.						
AS 414F (Single Station) with SIMATIC PCS 7 AS Runtime license for 100 POs CPU with 2 PROFIBUS interfaces (MPI/DP master and DP master) and 1 PN/IE interface (2 port switch) 4 MB RAM (2 MB each for program and data)	6ES7654-						
Type of delivery • Individual components, not pre-assembled • Pre-assembled and tested	7						G
Memory card • Memory card 2 MB RAM (up to approx. 100 POs) • Memory card 4 MB RAM (up to approx. 210 POs)	B						
CPU type • CPU 414-5H with SIMATIC S7 F Systems RT license (up to approx. 350 POs)		F					
Additive interface modules • Without additive interface module			0				
Interface to Industrial Ethernet plant bus • Without interface module • 1 × CP 443-1EX30 ¹⁾ • 2 × CP 443-1EX30 for redundant interface ¹⁾			0	3	4		
Racks • UR2 (9 slots), aluminum • UR2 (9 slots), steel • UR1 (18 slots), aluminum • UR1 (18 slots), steel						3	4
							5
							6
Power supply (without backup batteries) • 1 × PS 407, 10 A for 120/230 V UC • 1 × PS 407, 10 A for 120/230 V UC, optional redundancy • 1 × PS 407, 20 A for 120/230 V UC • 2 × PS 407, 10 A for 120/230 V AC/DC (redundant) • 1 × PS 405, 10 A for 24 V DC • 1 × PS 405, 10 A for 24 V DC, optional redundancy • 1 × PS 405, 20 A for 24 V DC • 2 × PS 405, 10 A for 24 V DC (redundant)							B
							C
							D
							E
							G
							H
							J
							K
Additive PROFIBUS DP interfaces • Without CP 443-5 Extended • 1 × CP 443-5 Extended • 2 × CP 443-5 Extended ¹⁾ • 3 × CP 443-5 Extended ¹⁾ • 4 × CP 443-5 Extended ¹⁾							0
							1
							2
							3
							4

¹⁾ Up to 5 CPs can be plugged into the UR2 rack with a single power supply or up to 3 with a redundant power supply.

Ordering data (continued)

	Article No.						
AS 416F (Single Station) with SIMATIC PCS 7 AS Runtime license for 100 POs CPU with 2 PROFIBUS interfaces (MPI/DP master and DP master) and 1 PN/IE interface (2 port switch) 16 MB RAM (6 MB for program and 10 MB for data)	6ES7654- - - - - - G						
Type of delivery							
• Individual components, not pre-assembled	7						
• Pre-assembled and tested	8						
Memory card							
• Memory card 4 MB RAM (up to approx. 210 POs)	C						
• Memory card 8 MB RAM (up to approx. 800 POs)	D						
• Memory card 16 MB RAM (up to approx. 2 100 POs)	E						
CPU type							
• CPU 416-5H with SIMATIC S7 F Systems RT license (up to approx. 1 200 POs)		Q					
Additive IF 964-DP interface module							
• Without additive IF 964-DP		0					
Interface to Industrial Ethernet plant bus							
• Without interface module			0				
• 1 × CP 443-1EX30 ¹⁾			3				
• 2 × CP 443-1EX30 for redundant interface ¹⁾			4				
Racks							
• UR2 (9 slots), aluminum				3			
• UR2 (9 slots), steel				4			
• UR1 (18 slots), aluminum				5			
• UR1 (18 slots), steel				6			
Power supply (without backup batteries)							
• 1 × PS 407, 10 A for 120/230 V AC/DC					B		
• 1 × PS 407, 10 A for 120/230 V AC/DC, optional redundancy					C		
• 1 × PS 407, 20 A for 120/230 V AC/DC					D		
• 2 × PS 407, 10 A for 120/230 V AC/DC (redundant)					E		
• 1 × PS 405, 10 A for 24 V DC					G		
• 1 × PS 405, 10 A for 24 V DC, optional redundancy					H		
• 1 × PS 405, 20 A for 24 V DC					J		
• 2 × PS 405, 10 A for 24 V DC (redundant)					K		
Additive PROFIBUS DP interfaces							
• Without CP 443-5 Extended						0	
• 1 × CP 443-5 Extended						1	
• 2 × CP 443-5 Extended ¹⁾						2	
• 3 × CP 443-5 Extended ¹⁾						3	
• 4 × CP 443-5 Extended ¹⁾						4	

¹⁾ Up to 5 CPs can be plugged into the UR2 rack with a single power supply or up to 3 with a redundant power supply.

	Article No.						
AS 417F (Single Station) with SIMATIC PCS 7 AS Runtime license for 100 POs CPU with 2 PROFIBUS interfaces (MPI/DP master and DP master) and 1 PN/IE interface (2 port switch) 32 MB RAM (16 MB each for program and data)	6ES7654- - - - - - G						
Type of delivery							
• Individual components, not pre-assembled	7						
• Pre-assembled and tested	8						
Memory card							
• Memory card 4 MB RAM (up to approx. 210 POs)	C						
• Memory card 8 MB RAM (up to approx. 800 POs)	D						
• Memory card 16 MB RAM (up to approx. 2 100 POs)	E						
CPU type							
• CPU 417-5H with SIMATIC S7 F Systems RT license (up to approx. 2 000 POs)		N					
Additive interface modules							
• Without additive interface module			0				
Interface to Industrial Ethernet plant bus							
• Without interface module				0			
• 1 × CP 443-1EX30 ¹⁾				3			
• 2 × CP 443-1EX30 for redundant interface ¹⁾				4			
Racks							
• UR2 (9 slots), aluminum					3		
• UR2 (9 slots), steel					4		
• UR1 (18 slots), aluminum					5		
• UR1 (18 slots), steel					6		
Power supply (without backup batteries)							
• 1 × PS 407, 10 A for 120/230 V UC						B	
• 1 × PS 407, 10 A for 120/230 V UC, optional redundancy						C	
• 1 × PS 407, 20 A for 120/230 V UC						D	
• 2 × PS 407, 10 A for 120/230 V AC/DC (redundant)						E	
• 1 × PS 405, 10 A for 24 V DC						G	
• 1 × PS 405, 10 A for 24 V DC, optional redundancy						H	
• 1 × PS 405, 20 A for 24 V DC						J	
• 2 × PS 405, 10 A for 24 V DC (redundant)						K	
Additive PROFIBUS DP interfaces							
• Without CP 443-5 Extended						0	
• 1 × CP 443-5 Extended						1	
• 2 × CP 443-5 Extended ¹⁾						2	
• 3 × CP 443-5 Extended ¹⁾						3	
• 4 × CP 443-5 Extended ¹⁾						4	

¹⁾ Up to 5 CPs can be plugged into the UR2 rack with a single power supply or up to 3 with a redundant power supply.

SIMATIC PCS 7 system hardware

Automation systems

Complementary S7-400 systems

Safety-related automation systems**Ordering data (continued)**

	Article No.										
	6	E	S	7	6	5	6	5	6	5	6
AS 412FH (Redundant Station) with SIMATIC PCS 7 AS Runtime license for 100 POs 2 × CPU each with 2 PROFIBUS interfaces (MPI/DP master and DP master) and 1 PN/IE interface (2-port switch) 2 × 1 MB RAM (512 KB each for program and data)											
Type of delivery											
• Individual components, not pre-assembled											7
• Pre-assembled and tested											8
Memory card											
• 2 × Memory Card 1 MB RAM (up to approx. 30 POs)											A
• 2 × Memory Card 2 MB RAM (up to approx. 100 POs)											B
CPU type											
• 2 × CPU 412-5H with SIMATIC S7 F Systems RT license (up to approx. 30 POs)											B
Sync modules and cables											
• 2 × 2 sync modules for distances up to 10 m and 2 × FO sync cable, 1 m											3
Interface to Industrial Ethernet plant bus											
• Without interface module											0
• 2 × CP 443-1EX30 for redundant interface ¹⁾											3
• 2 × 2 CP 443-1EX30 for 4-way connection ¹⁾											4
Racks											
• 1 × UR2-H (2 × 9 slots), aluminum											1
• 1 × UR2-H (2 × 9 slots), steel											2
• 2 × UR2 (9 slots), aluminum											3
• 2 × UR2 (9 slots), steel											4
Power supply (without backup batteries)											
• 2 × PS 407, 10 A for 120/230 V AC/DC											B
• 2 × PS 407, 10 A for 120/230 V AC/DC, optional redundancy											C
• 2 × PS 407, 20 A for 120/230 V AC/DC											D
• 2 × 2 PS 407, 10 A for 120/230 V AC/DC (redundant)											E
• 2 × PS 405, 10 A for 24 V DC											G
• 2 × PS 405, 10 A for 24 V DC, optional redundancy											H
• 2 × PS 405, 20 A for 24 V DC											J
• 2 × 2 PS 405, 10 A for 24 V DC (redundant)											K
Additive PROFIBUS DP interfaces											
• Without CP 443-5 Extended											0
• 2 × CP 443-5 Extended											1
• 2 × 2 CP 443-5 Extended ¹⁾											2
• 2 × 3 CP 443-5 Extended ¹⁾											3
• 2 × 4 CP 443-5 Extended ¹⁾											4

¹⁾ Up to 5 CPs can be plugged in per subsystem with a single power supply or up to 3 with a redundant power supply.

	Article No.										
	6	E	S	7	6	5	6	5	6	5	6
AS 414FH (Redundant Station) with SIMATIC PCS 7 AS Runtime license for 100 POs 2 × CPU each with 2 PROFIBUS interfaces (MPI/DP master and DP master) and 1 PN/IE interface (2-port switch) 2 × 4 MB RAM (2 MB each for program and data)											
Type of delivery											
• Individual components, not pre-assembled											7
• Pre-assembled and tested											8
Memory card											
• 2 × Memory Card 2 MB RAM (up to approx. 100 POs)											B
• 2 × Memory Card 4 MB RAM (up to approx. 210 POs)											C
CPU type											
• 2 × CPU 414-5H with SIMATIC S7 F Systems RT license (up to approx. 350 POs)											F
Sync modules and cables											
• 2 × 2 sync modules for distances up to 10 m and 2 × FO sync cable, 1 m											3
• 2 × 2 sync modules for up to 10 km and 2 × FO sync cable, 1 m, for testing											4
Interface to Industrial Ethernet plant bus											
• Without interface module											0
• 2 × CP 443-1EX30 for redundant interface ¹⁾											3
• 2 × 2 CP 443-1EX30 for 4-way connection ¹⁾											4
Racks											
• 1 × UR2-H (2 × 9 slots), aluminum											1
• 1 × UR2-H (2 × 9 slots), steel											2
• 2 × UR2 (9 slots), aluminum											3
• 2 × UR2 (9 slots), steel											4
Power supply (without backup batteries)											
• 2 × PS 407, 10 A for 120/230 V AC/DC											B
• 2 × PS 407, 10 A for 120/230 V AC/DC, optional redundancy											C
• 2 × PS 407, 20 A for 120/230 V AC/DC											D
• 2 × 2 PS 407, 10 A for 120/230 V AC/DC (redundant)											E
• 2 × PS 405, 10 A for 24 V DC											G
• 2 × PS 405, 10 A for 24 V DC, optional redundancy											H
• 2 × PS 405, 20 A for 24 V DC											J
• 2 × 2 PS 405, 10 A for 24 V DC (redundant)											K
Additive PROFIBUS DP interfaces											
• Without CP 443-5 Extended											0
• 2 × CP 443-5 Extended											1
• 2 × 2 CP 443-5 Extended ¹⁾											2
• 2 × 3 CP 443-5 Extended ¹⁾											3
• 2 × 4 CP 443-5 Extended ¹⁾											4

¹⁾ Up to 5 CPs can be plugged in per subsystem with a single power supply or up to 3 with a redundant power supply.

Ordering data (continued)

	Article No.						
AS 416FH (Redundancy Station) with SIMATIC PCS 7 AS Runtime license for 100 POs 2 × CPU each with 2 PROFIBUS interfaces (MPI/DP master and DP master) and 1 PN/IE interface (2-port switch) 2 × 16 MB RAM (6 MB each for program and 10 MB each for data)	6ES7656-						
Type of delivery • Individual components, not pre-assembled • Pre-assembled and tested	7 8						F
Memory card • 2 × Memory Card 4 MB RAM (up to approx. 210 POs) • 2 × Memory Card 8 MB RAM (up to approx. 800 POs) • 2 × Memory Card 16 MB RAM (up to approx. 2 100 POs)	C D E						
CPU type • 2 × CPU 416-5H with SIMATIC S7 F Systems RT license (up to approx. 1 200 POs)	Q						
Sync modules and cables • 2 × 2 sync modules for distances up to 10 m and 2 × FO sync cable, 1 m • 2 × 2 sync modules for up to 10 km and 2 × FO sync cable, 1 m, for testing	3 4						
Interface to Industrial Ethernet plant bus • Without interface module • 2 × CP 443-1EX30 for redundant interface ¹⁾ • 2 × 2 CP 443-1EX30 for 4-way connection ¹⁾	0 3 4						
Racks • 1 × UR2-H (2 × 9 slots), aluminum • 1 × UR2-H (2 × 9 slots), steel • 2 × UR2 (9 slots), aluminum • 2 × UR2 (9 slots), steel	1 2 3 4						
Power supply (without backup batteries) • 2 × PS 407, 10 A for 120/230 V AC/DC • 2 × PS 407, 10 A for 120/230 V AC/DC, optional redundancy • 2 × PS 407, 20 A for 120/230 V AC/DC • 2 × 2 PS 407, 10 A for 120/230 V AC/DC (redundant) • 2 × PS 405, 10 A for 24 V DC • 2 × PS 405, 10 A for 24 V DC, optional redundancy • 2 × PS 405, 20 A for 24 V DC • 2 × 2 PS 405, 10 A for 24 V DC (redundant)	B C D E G H J K						
Additive PROFIBUS DP interfaces • Without CP 443-5 Extended • 2 × CP 443-5 Extended • 2 × 2 CP 443-5 Extended ¹⁾ • 2 × 3 CP 443-5 Extended ¹⁾ • 2 × 4 CP 443-5 Extended ¹⁾	0 1 2 3 4						

¹⁾ Up to 5 CPs can be plugged in per subsystem with a single power supply or up to 3 with a redundant power supply.

	Article No.						
AS 417FH (Redundant Station) with SIMATIC PCS 7 AS Runtime license for 100 POs 2 × CPU each with 2 PROFIBUS interfaces (MPI/DP master and DP master) and 1 PN/IE interface (2-port switch) 2 × 32 MB RAM (16 MB each for program and data)	6ES7656-						
Type of delivery • Individual components, not pre-assembled • Pre-assembled and tested	7 8						F
Memory card • 2 × Memory Card 4 MB RAM (up to approx. 210 POs) • 2 × Memory Card 8 MB RAM (up to approx. 800 POs) • 2 × Memory Card 16 MB RAM (up to approx. 2 100 POs)	C D E						
CPU type • 2 × CPU 417-5H with SIMATIC S7 F Systems RT license (up to approx. 2 000 POs)	N						
Sync modules and cables • 2 × 2 sync modules for distances up to 10 m and 2 × FO sync cable, 1 m • 2 × 2 sync modules for up to 10 km and 2 × FO sync cable, 1 m, for testing	3 4						
Interface to Industrial Ethernet plant bus • Without interface module • 2 × CP 443-1EX30 for redundant interface ¹⁾ • 2 × 2 CP 443-1EX30 for 4-way connection ¹⁾	0 3 4						
Racks • 1 × UR2-H (2 × 9 slots), aluminum • 1 × UR2-H (2 × 9 slots), steel • 2 × UR2 (9 slots), aluminum • 2 × UR2 (9 slots), steel	1 2 3 4						
Power supply (without backup batteries) • 2 × PS 407, 10 A for 120/230 V AC/DC • 2 × PS 407, 10 A for 120/230 V AC/DC, optional redundancy • 2 × PS 407, 20 A for 120/230 V AC/DC • 2 × 2 PS 407, 10 A for 120/230 V AC/DC (redundant) • 2 × PS 405, 10 A for 24 V DC • 2 × PS 405, 10 A for 24 V DC, optional redundancy • 2 × PS 405, 20 A for 24 V DC • 2 × 2 PS 405, 10 A for 24 V DC (redundant)	B C D E G H J K						
Additive PROFIBUS DP interfaces¹⁾ • Without CP 443-5 Extended • 2 × CP 443-5 Extended • 2 × 2 CP 443-5 Extended ¹⁾ • 2 × 3 CP 443-5 Extended ¹⁾ • 2 × 4 CP 443-5 Extended ¹⁾	0 1 2 3 4						

¹⁾ Up to 5 CPs can be plugged in per subsystem with a single power supply or up to 3 with a redundant power supply.

SIMATIC PCS 7 system hardware

Automation systems

Complementary S7-400 systems

Safety-related automation systems

Ordering data

Article No.

Article No.

Individual components of safety-related automation systems

Ordering data	Article No.	Article No.
Individual components of the safety-related SIMATIC PCS 7 automation systems		
SIMATIC S7 F Systems RT License For processing safety-related user programs, for one AS 412F/FH, AS 414F/FH, AS 416F/FH or AS 417F/FH system	6ES7833-1CC00-6YX0	
CPU 412-5H PN/DP 1 MB RAM (512 KB each for program and data) Module occupies 2 slots	6ES7412-5HK06-0AB0	
CPU 414-5H PN/DP 4 MB RAM (2 MB each for program and data) Module occupies 2 slots	6ES7414-5HM06-0AB0	
CPU 416-5H PN/DP 16 MB RAM (6 MB for program and 10 MB for data) Module occupies 2 slots	6ES7416-5HS06-0AB0	
CPU 417-5H PN/DP 32 MB RAM (16 MB each for program and data) Module occupies 2 slots	6ES7417-5HT06-0AB0	
Sync set For linking the two redundant 412-5H, 414-5H, 416-5H or 417-5H CPUs; for distances up to <ul style="list-style-type: none"> 10 m, consisting of 4 sync modules for up to 10 m and 2 FO sync cables, 1 m each 10 km, consisting of 4 sync modules for up to 10 km Note: please order fiber-optic sync cables (2 units) in the required length separately. 	6ES7656-7XX30-0XE0 6ES7656-7XX40-0XE0	
Sync module For connection of the two CPU 412-5H, 414-5H, 416-5H or 417-5H; 2 modules required for each CPU, for distances up to <ul style="list-style-type: none"> 10 m 10 km 	6ES7960-1AA06-0XA0 6ES7960-1AB06-0XA0	
Sync cable (fiber-optic cable) For connecting the two 412-5H, 414-5H, 416-5H or 417-5H CPUs; each redundant automation system requires 2 cables <ul style="list-style-type: none"> 1 m 2 m 10 m Other lengths On request	6ES7960-1AA04-5AA0 6ES7960-1AA04-5BA0 6ES7960-1AA04-5KA0 On request	
Memory card RAM <ul style="list-style-type: none"> 1 MB 2 MB 4 MB 8 MB 16 MB 64 MB 	6ES7952-1AK00-0AA0 6ES7952-1AL00-0AA0 6ES7952-1AM00-0AA0 6ES7952-1AP00-0AA0 6ES7952-1AS00-0AA0 6ES7952-1AY00-0AA0	
Memory Card Flash EPROM Only required to update firmware; alternative: firmware update via the engineering system <ul style="list-style-type: none"> 16 MB 	6ES7952-1KS00-0AA0	
CP 443-1 Communication module for connecting SIMATIC S7-400 to Industrial Ethernet via TCP/IP, ISO and UDP; PROFINET IO controller, MRP; integrated real-time switch ERTEC with two ports; 2 × RJ45 interface; S7 communication, open communication (SEND/RECEIVE) with FETCH/WRITE, with or without RFC 1006, DHCP, SNMP V2, diagnostics, multicast, access protection via IP access list, initialization via LAN 10/100 Mbps; with electronic manual on DVD		6GK7443-1EX30-0XE0
CP 443-5 Extended Communication module for connection of SIMATIC S7-400 to PROFIBUS as DP master or for S7 communication, for increasing the number of DP lines, for data set routing with SIMATIC PDM and for 10 ms time stamping, electronic manual on CD; module occupies 1 slot		6GK7443-5DX05-0XE0
PS 407 power supply module with battery compartment for 2 backup batteries, module occupies 2 slots <ul style="list-style-type: none"> 10 A 120/230 V AC/DC; 5 V DC/10 A, 24 V DC/1 A 10 A, redundant 120/230 V AC/DC; 5 V DC/10 A, 24 V DC/1 A 20 A 120/230 V UC; 5 V DC/20 A, 24 V DC/1 A 		6ES7407-0KA02-0AA0 6ES7407-0KR02-0AA0 6ES7407-0RA02-0AA0
PS 405 power supply module with battery compartment for 2 backup batteries, module occupies 2 slots <ul style="list-style-type: none"> 10 A 24 V DC; 5 V DC/10 A, 24 V DC/1 A 10 A, redundant 24 V DC; 5 V DC/10 A, 24 V DC/1 A 20 A 24 V DC; 5 V DC/20 A, 24 V DC/1 A 		6ES7405-0KA02-0AA0 6ES7405-0KR02-0AA0 6ES7405-0RA02-0AA0
Backup battery Type AA, 2.3 Ah		6ES7971-0BA00
Aluminum rack <ul style="list-style-type: none"> UR1, 18 slots UR2, 9 slots UR2-H, for divided central controllers; 2 × 9 slots 		6ES7400-1TA11-0AA0 6ES7400-1JA11-0AA0 6ES7400-2JA10-0AA0
Steel rack <ul style="list-style-type: none"> UR1, 18 slots UR2, 9 slots UR2-H, for divided central controllers; 2 × 9 slots 		6ES7400-1TA01-0AA0 6ES7400-1JA01-0AA0 6ES7400-2JA00-0AA0
Runtime licenses for SIMATIC PCS 7 automation systems (can be added to existing licenses)		See "Individual components of standard automation systems"

Overview

The SIMATIC PCS 7 automation systems are extremely rugged, both electrically and mechanically. For extreme ambient conditions, hardened and refined SIPLUS extreme products are another alternative, especially in the case of:

- High humidity
- Condensation
- Chemically, mechanically or biologically active materials

You can find an overview of the complete SIPLUS extreme product range online at:

<http://www.siemens.com/siplus>

Under "Devices for extreme requirements > Controllers > Advanced Controllers", you will find conversion tools that display the SIPLUS S7-400 articles for the corresponding SIMATIC S7-400 articles.

SIMATIC PCS 7 system hardware

Notes

Industrial communication



14/2	Introduction
14/5	Industrial Ethernet
14/8	SCALANCE X switches product overview
14/11	SCALANCE X-100 unmanaged media converters
14/13	SCALANCE XB-000 switches
14/15	SCALANCE XC-100 switches
14/17	SCALANCE XB-200 switches
14/19	SCALANCE XC-200 switches
14/25	SCALANCE XC-200EEC switches
14/27	SCALANCE XP-200 switches
14/30	SCALANCE XF-200 switches
14/32	SCALANCE XF-200BA switches
14/35	– BusAdapter BA 2xRJ45VD HA
14/36	SCALANCE X-200RNA switches
14/39	RUGGEDCOM compact switch RNA
14/39	– RUGGEDCOM RSG900R managed
14/41	RUGGEDCOM rack switch
14/41	– RUGGEDCOM RST2228 managed
14/44	SCALANCE XR-300 switches
14/48	– Media modules
14/53	SCALANCE XR-300 WG switches
14/56	SCALANCE XM-400 switches
14/59	– Port extender
14/61	– PoE power supplies
14/62	SCALANCE XR-500 switches
14/65	– Media modules
14/69	– Power supply
14/70	SCALANCE accessories
14/71	– C-PLUG
14/74	– Plug-in transceiver
14/78	Passive network components
14/78	– FastConnect
14/83	– Fiber-optic cables
14/85	System connection PCS 7 systems
14/89	Industrial Wireless LAN
14/99	PROFINET
14/101	Architecture
14/102	PROFINET switches
14/103	SCALANCE XF-200BA DNA (Y-Switch) switches
14/106	IE/PB LINK
14/108	PROFINET Bus Analyzer (BANY)
14/111	PROFIBUS
14/112	PROFIBUS DP
14/113	– Electrical networks
14/115	– Optical networks
14/117	– AS connection
14/118	– Y-Link
14/119	PROFIBUS PA
14/123	– PA network transition
14/127	– Active field distributors for PA components
14/133	– Passive PA components
14/134	FOUNDATION Fieldbus H1
14/136	FF network transitions
14/139	Active field distributors for FF components
14/144	Passive FF components
14/145	OpenPCS 7
14/147	Other communication
14/147	AS-Interface
14/149	Modbus
14/149	– CP 341 communications module

SIMATIC PCS 7 system hardware

Industrial communication

Introduction

Overview



With the SIMATIC NET network components based on globally established standards, SIMATIC PCS 7 possesses a powerful and rugged range of products for implementing totally integrated communication networks for reliable data exchange between all system components and levels in a plant.

The SIMATIC NET products specially developed for industrial applications provide optimum suitability for plants in all sectors. They are matched to one another, and meet the highest industrial demands, especially in areas subject to extreme influences, such as:

- Extended temperature range
- Vibration
- High mechanical stress

The SIMATIC NET products guarantee expandability and the protection of investments as a result of compatible further developments, as well as uniformity from inbound logistics to outbound logistics and from field devices up to the Manufacturing Execution System (MES).

Design

Incorporated in Totally Integrated Automation, the unique basis offered by Siemens for uniform automation of all sectors in the production, process or hybrid industries, the SIMATIC NET portfolio ensures fast and reliable communication between the individual systems/applications of the SIMATIC PCS 7 process control system such as:

- Automation systems, distributed I/O and field components
- Engineering system, operator system and maintenance station
- SIMATIC BATCH and SIMATIC Route Control
- Web clients and web servers for operator control and monitoring via Internet/Intranet as well as IT applications

Industrial Ethernet plant bus

Industrial Ethernet is used as the plant bus as well as terminal bus for multi-user systems with client/server architecture. For small systems, the "Basic Communication Ethernet" (BCE) integrated in the SIMATIC PCS 7 Industrial Workstations permits operation of single stations and servers on the plant bus even without a CP 1623/CP 1628 communications module.

In medium and large plants with high requirements, SIMATIC PCS 7 applies modern FastEthernet and Gigabit technology that combines the high availability provided by redundant electrical and optical rings with the scalable performance provided by switching technology and high transmission rates of up to 10 Gbps.

PROFINET

PROFINET is based on the international standards IEC 61158 and IEC 61784 and combines the advantages of the open network standard, Ethernet, and the PROFIBUS fieldbus system. It stands for maximum transparency, open IT communication, network security and real-time communication down to the field level. This makes PROFINET the basis for uniform automation network in the plant, into which existing fieldbuses implemented with PROFIBUS can be easily integrated.

Design (continued)

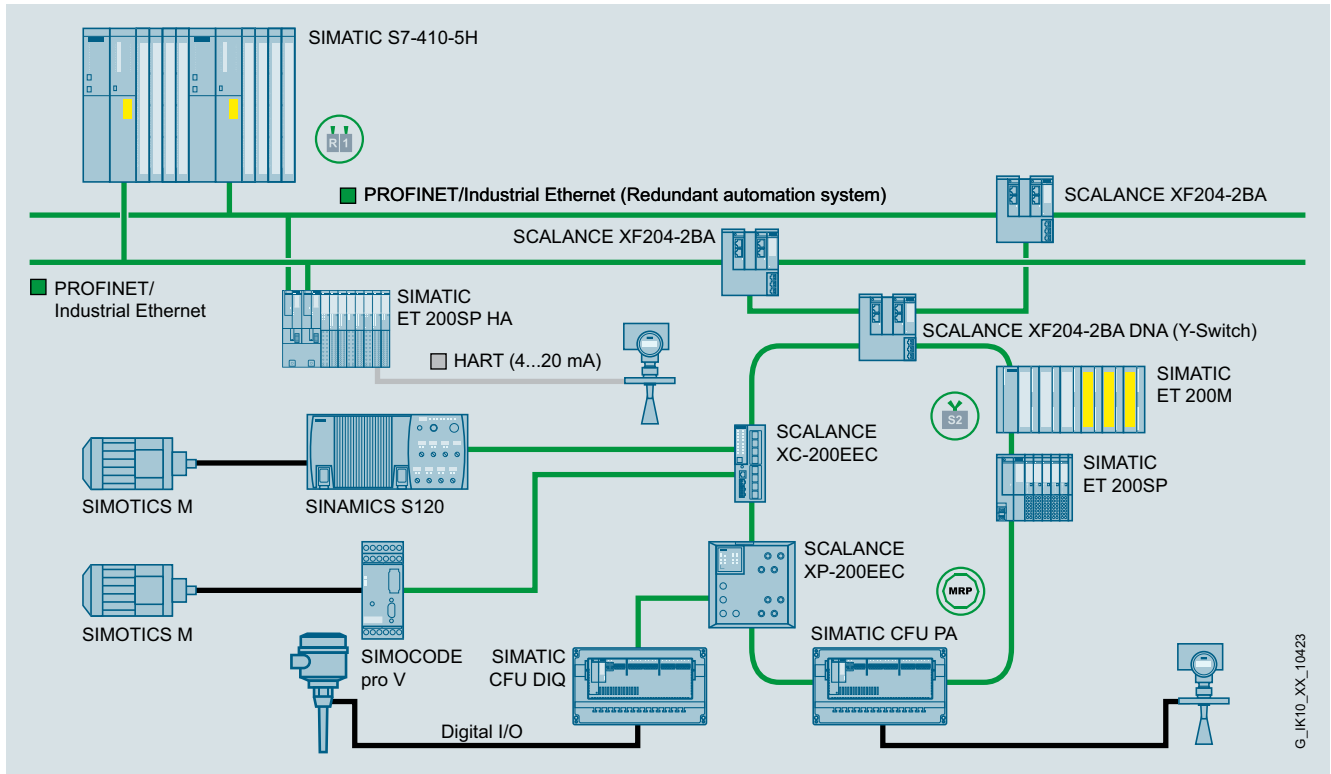

G_IK10_XX_10423

Example of PROFINET communication in the SIMATIC PCS 7 process control system

In the context of the SIMATIC PCS 7 process control system, PROFINET mainly focuses on communication between the automation systems (controllers) and the process I/O.

SIMATIC PCS 7 system hardware

Industrial communication

Introduction

Design (continued)

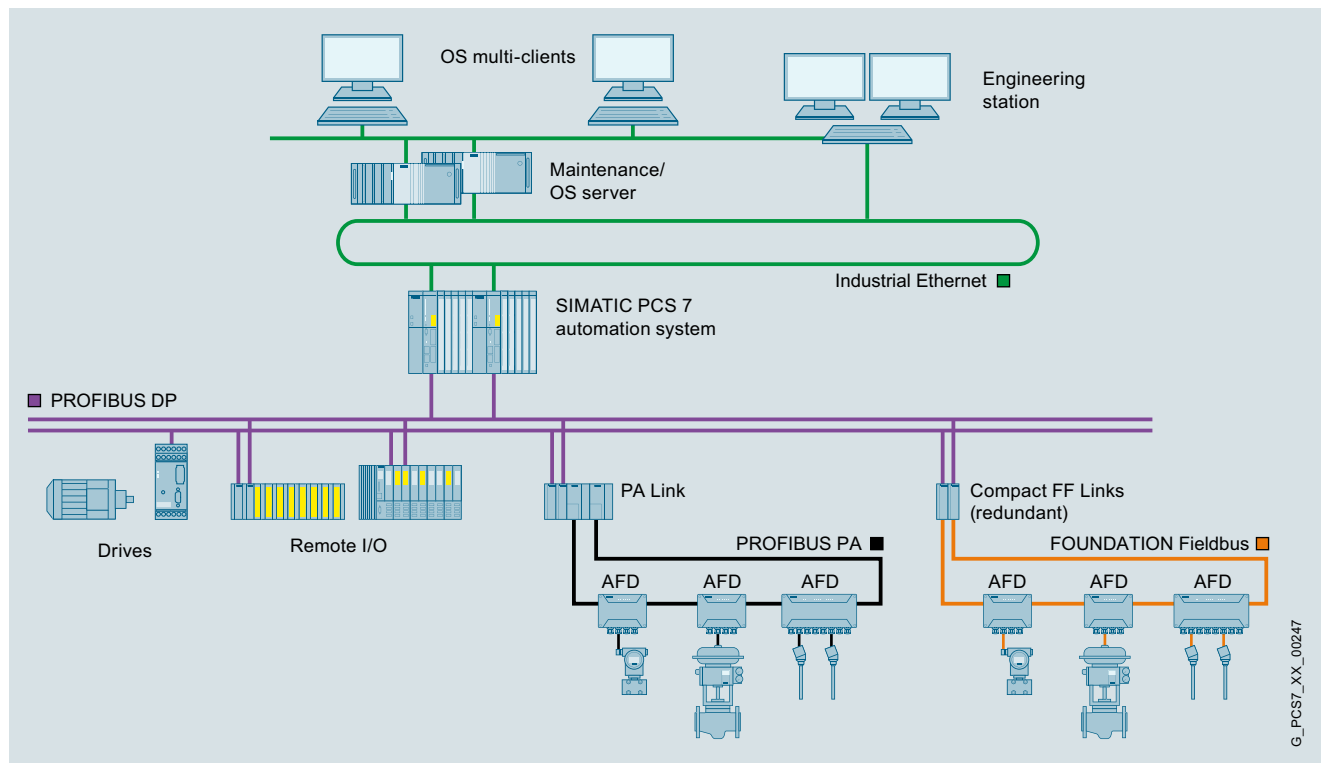

Integration of PROFIBUS PA and FOUNDATION Fieldbus H1

Fieldbus systems

PROFIBUS has become established as sturdy and reliable communications medium for connecting intelligent distributed I/O devices, transmitters and actuators to the controller level of the SIMATIC PCS 7 process control system. The universal, open fieldbus corresponds to the international standards IEC 61158 and IEC 61784.

PROFIBUS DP

PROFIBUS DP is both a system bus and an open communication system, and is designed for moderate transmission rates and short response times. It is therefore optimally suitable for the control of the following devices:

- Directly connected field devices, e.g. drives, motor starters, analyzers, process controllers, or panels
- Distributed I/O devices such as the SIMATIC ET 200M, SIMATIC ET 200iSP and SIMATIC ET 200pro remote I/O stations
- Transmitters and actuators on a seamlessly integrated PROFIBUS PA fieldbus or FOUNDATION Fieldbus H1

Since it also supports the transmission of the HART protocol, HART field devices can also be integrated in a PROFIBUS DP communication network.

PROFIBUS PA and FOUNDATION Fieldbus H1

In addition to the direct connection of transmitters and actuators including power supply via the communication medium, the high information content of the communication as well as the diagnostic options are also of importance for the automation of industrial processes that frequently take place in corrosive, harmful, and hazardous environments.

Both the PROFIBUS PA fieldbus and the FOUNDATION Fieldbus H1 meet these requirements. Both are optimally suitable for directly integrating actuators and sensors in operating environments up to Ex zone 1/21 or 0/20 into the process system.

Their physical bus characteristics are based on the MBP transmission technology (Manchester Coded; Bus Powered) and are largely identical according to IEC 61158. Both fieldbuses can be integrated seamlessly in the SIMATIC PCS 7 process control system using PROFIBUS DP as link.

PROFIBUS PA and FOUNDATION Fieldbus H1 thus profit equally from the higher-level PROFIBUS architecture.

G_PCS7_XX_00247

Overview

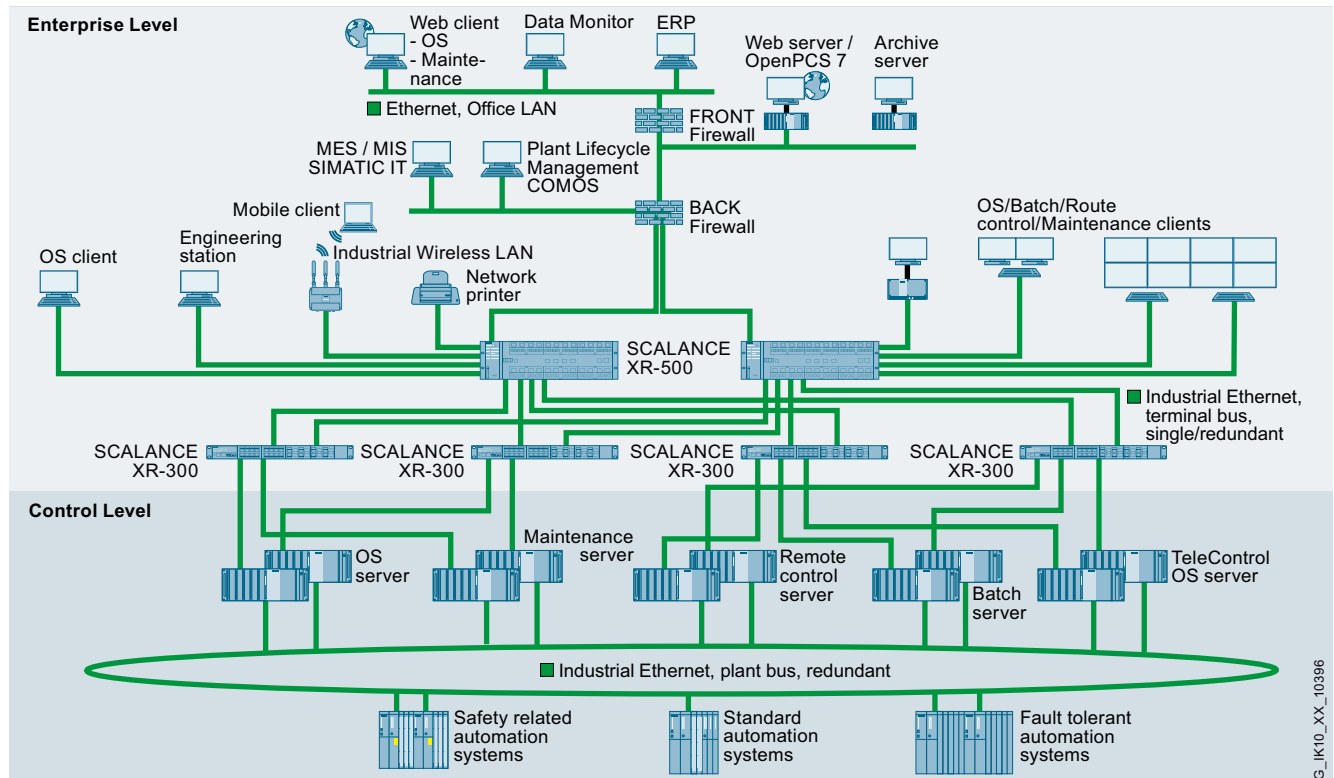

Typical configuration example for redundant plant bus

The plant bus and the terminal bus for multi-user systems with client/server architecture are implemented with Industrial Ethernet, a powerful area and cell network for industrial applications in line with the international IEEE 802.3 standard (Ethernet). Bus structures with optical rings are particularly suitable for this because of their interference immunity and high availability.

In medium-sized and large plants with high requirements, SIMATIC PCS 7 relies on modern FastEthernet and Gigabit technology. This combines the high reliability of optical rings with the scalable performance of switching technology and high transmission rates of up to 10 Gbps.

Benefits

Ethernet is now the number 1 network technology in the global LAN environment. Ethernet offers important characteristics that can give you significant advantages for your application:

- Fast commissioning through simple connections
- High flexibility since existing networks can be extended without any adverse effects
- High availability thanks to redundant network topologies
- Almost unlimited communications performance because scalable performance is available through switching technology if required
- Networking of different application areas (e.g. office and production)
- Investment security through continuous compatible further development
- Plant-wide clock system permits exact assignment of events within the entire system

Ethernet technology for industrial environments

With Industrial Ethernet, SIMATIC NET expands Ethernet technology with future-proof network components with special features and capabilities for use in industrial environments, for example:

- Rugged design, suitable for harsh industrial environments
- Fast local assembly using the FastConnect cabling system
- High fault tolerance due to redundancy and fast redundancy switchover, from bumpless redundancy through PRP and HSR to ring redundancy with MRP
- Continuous and central monitoring of network components with a simple yet effective signaling concept, and network management software

SIMATIC PCS 7 system hardware

Industrial communication

Industrial Ethernet

Design

The following Ethernet communications interfaces are used in the various SIMATIC PCS 7 subsystems (ES, OS, AS etc.):

- Interface modules integrated onboard
- Simple network adapters
- Special communications modules, e.g. CP 1623 and CP 1628

They are defined when selecting the respective system components, depending on the requirements. You can find more information in the section "System connection of PCS 7 systems".

The communication stations can be integrated in the terminal bus and the plant bus using Industrial Ethernet switches of the SCALANCE X product family. These switches offer scalable performance at an attractive price and support a wide variety of configuration options.

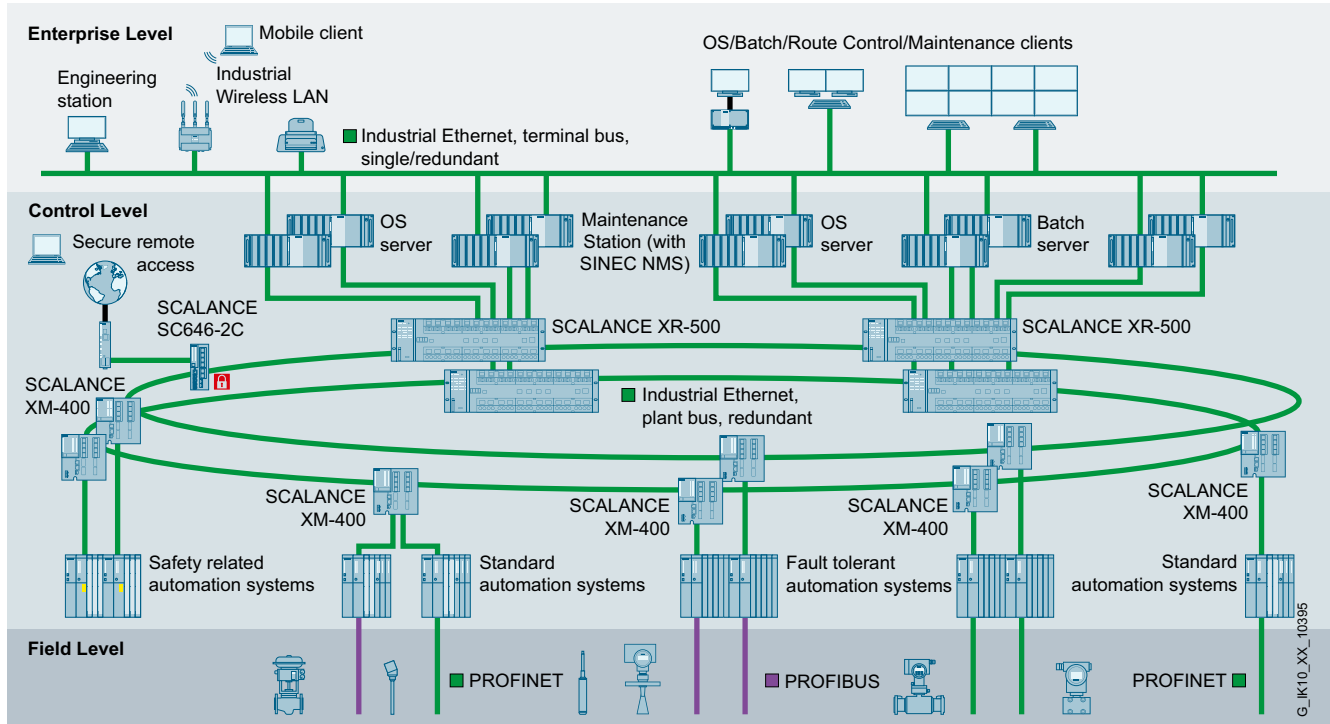

Configuration example for plant and terminal bus

Terminal bus

Client-server and server-server communication is carried out on a dedicated Ethernet LAN. The communication network identified as a terminal bus can be implemented with standard SIMATIC NET components such as Industrial Ethernet switches, onboard interface modules, network adapters, communications processors (CP), cabling, etc.

A ring design avoids communication failures should the line become damaged or disconnected at a particular point. To further increase availability, it is also possible to distribute terminal bus communication over two redundant rings. Each PCS 7 station is connected to one of two Industrial Ethernet ports on each of the two separate rings. The SIMATIC NET SOFTNET-IE RNA communication software on the PCS 7 stations organizes communication processes based on the PRP. Non-PRP-enabled terminal devices that have only one Industrial Ethernet port can be integrated in the redundant terminal bus via SCALANCE X204RNA.

According to IEC 62439-3, the **Parallel Redundancy Protocol (PRP)** is based on double transmission of message frames over two separate networks (Ring 1, Ring 2). On the sender side, the SOFTNET-IE RNA software or SCALANCE X-200RNA network access point duplicates the message frame arriving from the sender and feeds one message frame to Ring 1 and the other to Ring 2. On the receiver side, the software or network access point forwards the first incoming message frame to the recipient. The second message frame from the second LAN is discarded. Transmission of the message frame is thus always ensured without delay if an error occurs.

Design (continued)**Industrial Ethernet plant bus**

The automation systems (AS) communicate with one another and with the engineering system and Operator Systems (Servers/Single Stations) over the Industrial Ethernet plant bus. This can be configured in a similar way to the terminal bus, using SIMATIC NET standard components such as Industrial Ethernet switches, network adapters, communications modules (CP), cabling, etc. For small plants with up to 8 standard automation systems per Operator System, Single Stations and servers can be efficiently operated on the plant bus using "Basic Communication Ethernet" (BCE) and a FastEthernet network adapter. The CP 1623/CP 1628 communications module is always required if more than 8 automation systems or redundant automation systems are used.

As far as availability is concerned, ring topologies are always the first choice for the plant bus. With particularly high availability requirements, the plant bus can also be configured as a redundant double ring (two CPs per AS CPU and OS server). Double faults such as a switch failure on ring 1 with a simultaneous interruption in the bus cable on ring 2 can then be tolerated. The two rings in such a configuration are physically separated. The coupling partners are linked together logically when configuring with NetPro over a high-availability S7 connection (4-way redundancy). One switch each takes over the function of the redundancy manager for each ring. The current switches of the SCALANCE X-500, X-400, X-300 and X-200 product lines can act as redundancy manager in a ring.

Note:

Detailed information on Industrial Ethernet and network components can be found in Catalog IK PI, in the Industry Mall, or in Catalog CA 01 under "Industrial Communication".

SIMATIC PCS 7 system hardware

Industrial communication

Industrial Ethernet

SCALANCE X switches product overview

Overview



Managed Industrial Ethernet switches

Layer 2 Industrial Ethernet switches from Siemens include:

- Compact Switch Modules (CSMs)
- SCALANCE X Industrial Ethernet switches
- RUGGEDCOM Ethernet switches
- Communications processors (CP) with integral switch

Compact Switch Modules (CSMs)

Unmanaged switches for use directly on the SIMATIC for interface expansion and integration of machines into existing plant networks.

SCALANCE X-000 unmanaged

Unmanaged switches with electrical and/or optical ports for designing small networks for machine or plant islands with 10/100/1 000 Mbps. In addition, 24 V AC versions are available for use in building automation.

SCALANCE X-100 unmanaged

Switches with electrical and/or optical ports, redundant power supply, and signaling contact for use in machine-level applications. In addition, 24 V AC versions for use in building automation and devices in 19" rack design are available.

SCALANCE X-200 managed

For universal use, from machine-level applications to networked subsystems with data transfer rates up to 1 000 Mbps. Configuration and remote diagnostics are integrated into the STEP 7/TIA Portal engineering tool. This increases plant availability. Devices with a high degree of protection facilitate cabinet-free setup.

Corresponding switches are also available for use in subsystem networks with hard real-time requirements (Isochronous Real Time – IRT) and in H systems with maximum availability with S2 diagnostics, CiR/H-CiR and H-Sync. Versions with SFP plug-in transceivers are available to allow a choice between electrical and optical ports.

In addition, versions are offered for various applications – in the form of SIMATIC ET 200S, ET 200SP or S7-1500 assembly and also assembly without control cabinets.

SCALANCE X-300 managed

Networking of subsystems/plant areas, as well as connection to the shopfloor. The SCALANCE X-300 managed product line combines the firmware functionality of the SCALANCE X-400 line with the compact design of the SCALANCE X-200 line. This means the SCALANCE X-300 switches have extended management functions and an extended firmware functionality compared to the SCALANCE X-200 switches. Devices in the 19" rack design are also available, both as fully or partially modular devices and as so-called work group switches.

SCALANCE XM-400 managed (layer 3)

For flexible networking and structuring of high-performance plant networks. Thanks to the modular design, the switches can be adapted to the respective task. Using Port Extenders, the switches can be upgraded to up to 24x 10/100/1 000 Mbps ports, of which up to 8x ports can supply data and power to terminals with Power over Ethernet capability. In addition, SFP plug-in transceivers allow the XM-400 devices to be equipped with single-mode and/or multimode SFPs at 100 Mbps and/or 1 000 Mbps.

Optional routing functions on layer 3 permit communication between different IP subnetworks.

SCALANCE XR-500 managed (Layer 3)

For networking and structuring high-performance industrial networks and for connecting office networks to automation networks. As a Layer 3 switch, SCALANCE XR-500 is extremely well suited to use as a central component in backbone networks, e.g. when a high number of ports is required, at extremely high transmission rates (10 Gigabit Ethernet), or for redundant connection to an office infrastructure. The rack switches are especially designed for use in 19" control cabinets. The modular variants feature versatile plug-in 4-port media modules (electrical and optical) which can adapt to the respective requirements.

Optional routing functions on layer 3 permit communication between different IP subnetworks.

RUGGEDCOM Ethernet switches

Compact, modular managed switches available in both top hat DIN rail and rack versions. RUGGEDCOM switches are mainly intended for use in the power supply field, where the devices are able to work reliably in the electrically hostile and climatically demanding environments present in substations and industrial plants.

Communications processors for SIMATIC with integral switch















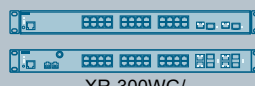
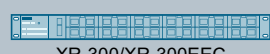

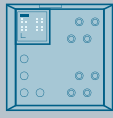





Managed switches for adding Industrial Ethernet/PROFINET interfaces to the SIMATIC and for integrating the controllers into existing line or ring topologies.

Thanks to integral layer 3 functionality, the Advanced-CPs can also be used as routers between IP subnets.

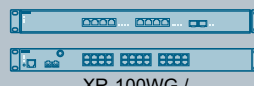
Communications processors for PC with integral switch

Managed switches for adding Industrial Ethernet/PROFINET interfaces to industrial PCs and for integrating PCs into existing line topologies.

Overview (continued)

		Network components (SCALANCE X)			CSM (Compact Switch Module)					
Backbone Layer	X-500 managed	 <p>XR-500</p>								
	X-400 managed	 <p>XM-400</p>	 <p>PE-400</p>							
Aggregation Layer	X-300 managed	 <p>X-300</p>	 <p>XR-300WG/ XR-300PoE WG</p>	 <p>XR-300/XR-300EEC</p>						
	X-200 managed	 <p>XB-200</p>	 <p>XC-200 / G / POE</p>	 <p>XP-200/ XP-200PoE EEC</p>	 <p>XF-200BA</p>	 <p>XF-200</p>				
Cell Layer	X-200IRT managed	 <p>X-200RNA</p>	 <p>X-200IRT</p>	 <p>X-200IRT PRO</p>	 <p>XF-200IRT</p>	 <p>X-200P IRT</p>				
	X-100 unmanaged	 <p>XB-100</p>	 <p>XC-100</p>	 <p>XR-100WG / XR-100PoE WG</p>	 <p>X-100 Media converter</p>					
	X-000 unmanaged	 <p>X-000</p>	 <p>XB-000</p>							
							 <p>LOGO! CSM</p>	 <p>CSM 1277</p>	 <p>CSM 377</p>	

G_1K10_XX_10255

Portfolio overview of managed and unmanaged Layer 2 and Layer 3 Industrial Ethernet switches

SIMATIC PCS 7 system hardware

Industrial communication

Industrial Ethernet

SCALANCE X switches product overview

Overview (continued)

	Areas of application / Type of networks / Requires	Office connection	Plant networking	Industry-related applications	Process automation	Power generation and distribution	Wind farms	Machinery and plant engineering	Unit networking	Standard mechanical engineering	Machine-internal networking	Network setup through SIMATIC S7-300, S7-1200 or LOGO!
X-500	Powerful backbone network with very high requirements on functionality / port density / availability as well as interface to Office IT	•	•	•								
X-400	Powerful plant network with high demand on functionality and availability	•	•	•								
X-300	Large networks with high demand on functionality and availability		•	•	•	•						
X-200	Networks with high demand on functionality and availability		•	•	•	•	•	•	•	•		
X-100	Networks with low demand on functionality						•	•	•	•		
X-000	Networks with low demand on functionality and ruggedness									•	•	
CSM	Networks or interface extension for SIMATIC S7-300, S7-1200, LOGO!											•

G_IK10_XX_10301

• applies to selected versions

SCALANCE X Industrial Ethernet switches: Areas of application

	Layer 3 / Routing	19" design	Modular through media modules	Support of Gigabit Ethernet	Support of 10 Gbit/s	PROFINET	EtherNet/IP	Office features (VLAN)	Diagnostic functions	Isynchronous Real-Time (IRT)	Power-over-Ethernet	Can be used under enhanced ambient conditions	Time synchronization to IEEE 1588	Additional interface for SIMATIC S7-300/ ET 200M, S7-1200 or LOGO!
X-500	•	•	•	•	•	•	•	•	•				•	
X-400	•		•	•	•	•	•	•	•		•			
X-300		•	•	•	•	•	•	•	•		•	•	•	
X-200				•	•	•	•	•	•	•	•	•		
X-100		•		•	•						•			
X-000				•								•		
CSM														•

G_IK10_XX_10302

• applies to selected versions

SCALANCE X Industrial Ethernet switches: Overview of functions

More information

Selection tool:

To support the selection of SCALANCE network components, the TIA selection tool is available at:

<http://www.siemens.com/tst>

Overview



The unmanaged Industrial Ethernet media converters of the SCALANCE X-100 product line are ideally suited to converting electrical signals into optical signals in Industrial Ethernet networks at data transfer rates of 10/100 Mbps in line and star topologies.

- Electrical or optical connection to nodes or networks according to port characteristics of the devices
- Rugged metal enclosure for space-saving cubicle mounting on standard rails, SIMATIC S7-300 DIN rails, or for wall mounting
- Rugged node connections with industry-standard RJ45 plug-in connectors with retaining collar that offers additional strain and bending strain relief thanks to latching on the enclosure
- Redundant power supply
- Diagnostics on the device by means of LEDs (power, link status, data communication)
- Error signaling contact with easy adjustment using the SET button

Product variants

SCALANCE X101-1, SCALANCE X101-1LD

- For converting electrical signals into optical signals in Industrial Ethernet line, star and ring topologies
- The Industrial Ethernet media converters have an electrical 10/100 Mbps RJ45 port and:
 - SCALANCE X101-1
1x 100 Mbps ST/BFOC port, optical (multi-mode, glass FOC)
 - SCALANCE X101-1LD
1x 100 Mbps ST/BFOC port, optical (single-mode, glass FOC)
- Redundant power supply with 2 x 24 V DC
- Diagnostics on the device using LEDs (power, link status, data traffic) and signaling contact (message screen can be set using a button on the device)
- The electric RJ45 port is industry standard and features an additional retaining collar for optimal connection of the IE FC RJ45 plugs

Benefits

get Designed for Industry

- Ideal solution for converting electrical signals into optical signals in Industrial Ethernet line, star and ring topologies
- Space-saving installation in the cabinet thanks to compact design in SIMATIC S7-300 format
- Reliable plug-in connection with industry-standard FastConnect plugs
- Cost savings, since installation is possible without a patch field by means of IE FC RJ45 plugs and IE FC standard cables

Design

The SCALANCE Industrial Ethernet media converters with a rugged metal enclosure are optimized for mounting on a standard rail and a SIMATIC S7-300 DIN rail. Direct wall mounting in various positions is also possible. Thanks to the dimensions of the enclosure that correspond to those of the SIMATIC S7-300, the devices are ideally suited for integration in an automation solution with SIMATIC S7-300 components.

The SCALANCE X-100 media converters feature:

- A 4-pin terminal block for connecting the redundant supply voltage (2 x 24 V DC)
- A row of LEDs for displaying status information (power, link status, data communication, signaling contact)
- A 2-pin terminal block for connecting the floating signaling contact
- A SET button for local configuration of the signaling contact and of cascading mode

The following port types are available:

- **10/100BaseTX, RJ45 port:**
Automatic detection of the data rate (10 or 100 Mbps), with autosensing and autocrossover function for connecting IE FC cables via IE FC RJ45 plugs over distances up to 100 m
- **100BaseFX, BFOC port with glass fiber-optic cable:**
For direct connection to Industrial Ethernet glass fiber-optic cables up to 3000 m or 26000 m for configuring line, star or ring topologies

SIMATIC PCS 7 system hardware

Industrial communication

Industrial Ethernet

SCALANCE X-100 unmanaged media converters

Ordering data

SCALANCE X-100 unmanaged media converter

Unmanaged Industrial Ethernet media converters, LED diagnostics, fault signaling contact with SET key, redundant power supply, PROFINET-compatible securing collars; manual available as download

- **SCALANCE X101-1**
1 x 10/100 Mbps RJ45 port
1 x 100 Mbps multimode FOC BFOC
- **SCALANCE X101-1LD**
1 x 10/100 Mbps RJ45 port
1 x 100 Mbps single-mode FOC BFOC

SIPLUS SCALANCE X101-1

1 x 10/100 Mbps RJ45 port
1 x 100 Mbps multimode BFOC

Accessories

SITOP compact 24 V/0.6 A

1-phase power supply with wide-range input
85 – 264 V AC/110 – 300 V DC, stabilized output voltage 24 V, rated output current value 0.6 A, slim design

IE FC Stripping Tool

Pre-adjusted stripping tool for fast stripping of Industrial Ethernet FC cables

IE FC RJ45 plug 180 2 x 2

RJ45 plug-in connector for Industrial Ethernet with a rugged metal enclosure and integrated insulation displacement contacts for connecting Industrial Ethernet FC installation cables; 180° cable outlet; for network components and CPs/CPUs with Industrial Ethernet interface

- 1 pack = 1 unit

IE FC TP standard cable GP 2 x 2 (Type A)

4-core, shielded TP installation cable for connection to IE FC outlet RJ45/IE FC RJ45 plug; PROFINET-compatible; with UL approval; sold by the meter; max. length 1 000 m, minimum order quantity 20 m

Article No.

6GK5101-1BB00-2AA3

6GK5101-1BC00-2AA3

6AG1101-1BB00-4AA3

6EP1331-5BA00

6GK1901-1GA00

6GK1901-1BB10-2AA0

6XV1840-2AH10

Article No.

IE TP Cord RJ45/RJ45

TP cable 4 x 2 with 2 RJ45 plugs

- 1 m
- 2 m
- 10 m

FC FO Termination Kit

Assembly case for local assembly of FC SC and FC BFOC connectors on FC FO standard cable, comprising a stripping tool, Kevlar cutters, fiber breaking tool and microscope

FC BFOC plug

Screw connector for on-site assembly on FC fiber-optic cable; (1 pack = 20 units + cleaning cloths)

FC FO standard cable GP 62.5/200/230

FC FO standard cable for fixed routing indoors with PVC sheath; sold by the meter; max. length 1 000 m; minimum order 20 m

Multimode FO BFOC connector set

For FO standard cable (50/125/1400), FO ground cable (50/125/1400), flexible FO trailing cable, INDOOR FC cable (62.5/125/900), 20 units

Standard cable GP? (50/125/1400/OM2++) segmentable 2)

Multimode cable, sold by the meter; max. length 1000 m; minimum order 20 m;

MM FO cord SC/BFOC

With one SC duplex connector and two BFOC connectors, 1 m

SM FO cord SC/BFOC

With one SC duplex connector and two BFOC connectors, 1 m

Screw-type terminal block

For SCALANCE X/W/S

- 2-pin for signaling contact (24 V DC) 1 pack = 5 units
- 4-pin for power supply (24 V DC) 1 pack = 5 units

6XV1870-3QH10

6XV1870-3QH20

6XV1870-3QN10

6GK1900-1GL00-0AA0

6GK1900-1GB00-0AC0

6XV1847-2A

6GK1901-0DA20-0AA0

6XV1873-2A

6XV1843-5EH10-0CB0

6XV1843-5FH10-0CB0

6GK5980-0BB00-0AA5

6GK5980-1DB00-0AA5

Overview



The unmanaged Industrial Ethernet switches of the SCALANCE XB-000 line are ideal for installing Industrial Ethernet networks in line and star topologies.

- Enclosure for space-saving installation in control cabinets or boxes on a standard DIN rail

Product variants

- **SCALANCE XB005 and SCALANCE XB008**
5 or 8 x 10/100 Mbps RJ45 ports, electrical
- **SCALANCE XB005G and SCALANCE XB008G (Gigabit)**
5 or 8 x 10/100/1000 Mbps RJ45 ports, electrical
- **SCALANCE XB004-1**
4 x 10/100 Mbps RJ45 ports, electrical
1 x 100 Mbps SC port, optical (multimode, glass), up to 5 km
- **SCALANCE XB004-2**
4 x 10/100 Mbps RJ45 ports, electrical
2 x 100 Mbps SC ports, optical (multimode, glass), up to 5 km
- **SCALANCE XB004-1LD (long distance)**
4 x 10/100 Mbps RJ45 ports, electrical
1 x 100 Mbps SC port, optical (single-mode, glass), up to 26 km
- **SCALANCE XB004-1G (Gigabit)**
4 x 10/100/1 000 Mbps RJ45 ports, electrical
1 x 1 000 Mbps SC port, optical (multimode, glass), up to 750 m
- **SCALANCE XB004-1LDG (long distance)**
4 x 10/100/1000 Mbps RJ45 ports, electrical
1 x 1000 Mbps SC port, optical (single-mode, glass), up to 10 km

Benefits

g e t Designed for Industry

- Implementation of simple and very economical machine networking
- Space-saving installation thanks to small, compact design
- Can be used in industrial environments
- Fast commissioning without configuration
- Easy on-site diagnostics via LEDs
- Uncomplicated use of uncrossed connecting cables possible thanks to the integrated Autocrossover function
- Low-cost connection of especially remote nodes possible
- 24 V AC versions for use in building automation

Design

The SCALANCE XB-000 Industrial Ethernet switches are optimized for installation on a standard rail. Wall mounting is possible.

The SCALANCE XB-000 switches have:

- A 3-pole terminal block for connecting the power supply (1 x 24 V DC) and functional ground
- An LED for indicating the status information (power)
- LEDs for indicating the status information (link status and data exchange) per port

The following port types are available:

- 10/100 BaseTX electrical RJ45 ports or 10/100/1000 BaseTX electrical RJ45 ports:
automatic data transmission rate detection (10 or 100 Mbps), with Autosensing and Autocrossing function for connecting IE TP cables up to 100 m.
- 100 BaseFX, optical SC port:
for direct connection to Industrial Ethernet FO cables. Multimode fiber-optic cable up to 5 km
- 100 BaseFX, optical SC port:
for direct connection to Industrial Ethernet FO cables. Single mode fiber-optic cable up to 26 km
- 1000 BaseSX, optical SC port:
for direct connection to Industrial Ethernet FO cables. Multimode fiber-optic cable up to 750 m
- 1000 BaseLX, optical SC port:
for direct connection to Industrial Ethernet FO cables. Single mode fiber-optic cable up to 10 km

All connections for data cables are located at the front, and the connection for the power supply is at the bottom.

SIMATIC PCS 7 system hardware

Industrial communication

Industrial Ethernet

SCALANCE XB-000 switches**Ordering data****Article No.****SCALANCE XB-000 Industrial Ethernet Switches**

Unmanaged Industrial Ethernet switches for 10/100/1 000 Mbps, LED diagnostics, manual available as download

- **SCALANCE XB005**
5 x 10/100 Mbps RJ45 ports electrical
- **SCALANCE XB008**
8 x 10/100 Mbps RJ45 ports electrical
- **SCALANCE XB004-1**
4 x 10/100 Mbps RJ45 ports electrical
1x 100 Mbps SC port optical (multimode, glass), up to 5 km
- **SCALANCE XB004-2**
4 x 10/100 Mbps RJ45 ports, electrical
2 x 100 Mbps SC ports, optical (multimode, glass), up to 5 km
- **SCALANCE XB004-1LD**
4 x 10/100 Mbps RJ45 ports electrical
1x 100 Mbps SC port optical (single-mode, glass), up to 26 km
- **SCALANCE XB005G**
5 x 10/100/1 000 Mbps electrical RJ45 ports
- **SCALANCE XB008G**
8 x 10/100/1 000 Mbps electrical RJ45 ports
- **SCALANCE XB004-1G**
4 x 10/100/1 000 Mbps RJ45 electrical ports
1x 1000 Mbps optical SC port (multimode, glass), up to 0.75 km
- **SCALANCE XB004-1LDG**
4 x 10/100/1 000 Mbps electrical RJ45 ports
1x 1 000 Mbps SC optical port (single-mode, glass), up to 10 km

6GK5005-0BA00-1AB2**6GK5008-0BA10-1AB2****6GK5004-1BD00-1AB2****6GK5004-2BD00-1AB2****6GK5004-1BF00-1AB2****6GK5005-0GA10-1AB2****6GK5008-0GA10-1AB2****6GK5004-1GL10-1AB2****6GK5004-1GM10-1AB2****Article No.****Accessories****SITOP compact 24 V/0.6 A**

Single-phase power supply with wide-range input 85 – 264 V AC/110 – 300 V DC, stabilized output voltage 24 V, rated output current value 0.6 A, slim design

6EP1331-5BA00**LOGO!Power 24 V/1.3 A**

Stabilized power supply
Input: 100-230 V AC (110-300 V DC)
Output: 24 V DC/1.3 A

6EP1331-1SH03**SCALANCE TAP104**

Test access port for the reaction-free extraction of Ethernet data frames (10/100 Mbps) from both transmission directions; extracts complete data traffic, including faulty frames, for further diagnostics.

6GK5104-0BA00-1SA2**IE TP Cord RJ45/RJ45**

Pre-assembled 8-wire Cat6A patch cable 4 x 2, with two RJ45 connectors, preferred length

- 0.3 m
- 0.5 m
- 1 m
- 2 m
- 3 m
- 4 m
- 6 m
- 10 m
- 15 m
- 20 m
- 25 m
- 30 m
- 35 m
- 40 m
- 45 m
- 50 m

6XV1870-3QE30
6XV1870-3QE50
6XV1870-3QH10
6XV1870-3QH20
6XV1870-3QH30
6XV1870-3QH40
6XV1870-3QH60
6XV1870-3QN10
6XV1870-3QN15
6XV1870-3QN20
6XV1870-3QN25
6XV1870-3QN30
6XV1870-3QN35
6XV1870-3QN40
6XV1870-3QN45
6XV1870-3QN50

FO Standard Cable GP 50/125/1400

Multimode cable, sold by the meter; max. delivery unit 1 000 m, minimum order quantity 20 m, also available pre-assembled with SC connectors in various lengths

6XV1873-2A**Notes:**

- You can find more information on the FastConnect range in the <https://support.industry.siemens.com/cs/document/109766358/ordering-overview-cabling-technology-for-communication-networks-in-industry?dti=0&lc=en-DE> ordering overview
- You can order supplementary components for the SIMATIC NET cabling range from your local contact. Technical advice on this subject is available from:
J. Hertlein
DI PA CI PRM 4
Tel.: +49 (172) 3172810
E-mail: juergen.hertlein@siemens.com

Overview



The unmanaged Industrial Ethernet switches of the SCALANCE XC-100 product line are optimized for installing Industrial Ethernet networks at transmission rates of 10/100 Mbps in line and star topologies for machine-level applications:

- Connection to stations or networks according to the port type of the devices – electrical with RJ45 port or optical with ST/BFOC or SC port
- Space-saving control cabinet installation on standard DIN rail, SIMATIC S7-300, S7-1500 DIN rail, or for wall mounting
- Rugged station connections with industry-standard RJ45 plug-in connectors that offer additional strain and bending strain relief thanks to latching on the enclosure (retaining collar)
- Redundant power supply
- Clear diagnostics display on the device by means of LEDs (power, link status, data communication)
- Error signaling contact with easy adjustment using the SET button

Product versions

SCALANCE XC106-2 / SCALANCE XC108 / SCALANCE XC116 / SCALANCE XC124 / SCALANCE X108 PoE

- Construction of optical Industrial Ethernet line or star topologies:
 - SCALANCE XC106-2
With 6 electrical ports (RJ45 with retaining collar) and 2 optical ports (ST/BFOC)
 - SCALANCE XC106-2
With 6 electrical ports (RJ45 with retaining collar) and 2 optical ports (SC)
 - SCALANCE XC108
With 8 electrical ports (RJ45 with retaining collar)
 - SCALANCE XC116
With 16 electrical ports (RJ45 with securing collar)
 - SCALANCE XC124
With 24 electrical ports (RJ45 with securing collar)
- Diagnostics on the device using LEDs (power, link status, data traffic) and signaling contact (message screen can be set using a button on the device)
- The RJ45 ports are suitable for industrial use and have additional retaining collars, optimized for connecting the IE FC RJ45 Plug 180.

Benefits

get Designed for Industry

- Ideal solution for configuring Industrial Ethernet line and star topologies
- Space-saving installation in the control cabinet thanks to compact design in SIMATIC S7-1500 format and mounting option on the SIMATIC S7-1500 DIN rail
- Extended temperature range from -40 °C to +70 °C (X108PoE: -20 °C to +60 °C)
- Reliable device connection with industry-standard FastConnect plugs
- Installation is possible without a patch field by means of IE FC RJ45 Plug 180 and IE FC Standard Cable
- Uncrossed connecting cables can be used due to the integrated autocrossover function

Design

The SCALANCE Industrial Ethernet switches with enclosure rear sections of metal are optimized for mounting on a standard DIN rail and an S7-1500 DIN rail. Direct wall mounting in various positions is also possible. Thanks to the enclosure dimensions that correspond to those of the SIMATIC S7-1500, the devices are ideally suited for integration into automation solutions and mounting on the SIMATIC S7-1500 DIN rail. Mounting on a SIMATIC S7-300 DIN rail is also possible.

The SCALANCE XC-100 switches feature:

- A 4-pin terminal block for connecting the redundant supply voltage (2 x 24 V DC)
- A raised row of LEDs for displaying status information (power, link status, data communication, signaling contact)
- A 2-pin terminal block for connecting the floating signaling contact
- A SET button for on-site configuration of the signaling contact

The following port types are available:

- **10/100BaseTX, RJ45 port;**
automatic detection of the data rate (10 or 100 Mbps), with autosensing and autocrossover function for connecting IE FC cables via IE FC RJ45 Plug 180 over distances up to 100 m
- **100BaseFX, ST/BFOC port;**
for direct connection to the Industrial Ethernet glass FOC up to 5 km
- **100BaseFX, SC port;**
for direct connection to the Industrial Ethernet glass FOC up to 5 km

SIMATIC PCS 7 system hardware

Industrial communication

Industrial Ethernet

SCALANCE XC-100 switches

Ordering data

SCALANCE XC-100 Industrial Ethernet Switches

Unmanaged Industrial Ethernet switches for 10/100 Mbps, manual available as download

- **SCALANCE XC106-2**
6 x 10/100 Mbps RJ45 ports, electrical
2 x ST/BFOC ports, optical (multimode BFOC, glass) up to 5 km
- **SCALANCE XC106-2**
6 x 10/100 Mbps RJ45 ports, electrical
2 x ST/BFOC ports, optical (multimode SC, glass)
- **SCALANCE XC108**
8 x 10/100 Mbps RJ45 ports, electrical
- **SCALANCE XC116**
16 x 10/100 Mbps RJ45 ports, electrical
- **SCALANCE XC124**
24 x 10/100 Mbps RJ45 ports, electrical

Accessories

S7-1500 PM 1507 Power Supply

SIMATIC PM 1507 24 V/3 A stabilized power supply for SIMATIC S7-1500
Input: 120/230 V AC
Output 24 V DC/3 A

S7-1500 PM 1507 Power Supply

SIMATIC PM 1507 24 V/8 A stabilized power supply for SIMATIC S7-1500
Input: 120/230 V AC
Output 24 V DC/8 A

SCALANCE TAP104

Test access port for the reaction-free extraction of Ethernet data frames (10/100 Mbps) from both transmission directions; extracts complete data traffic, including faulty frames, for further diagnostics.

IE FC RJ45 Plug 180 2 x 2

RJ45 plug-in connector for Industrial Ethernet with a rugged metal housing and integrated insulation displacement contacts for connecting Industrial Ethernet FC installation cables; with 180° cable outlet; for network components and CPs/CPUs with Industrial Ethernet interface

- 1 pack = 1 unit

Article No.

6GK5106-2BB00-2AC2

6GK5106-2BD00-2AC2

6GK5108-0BA00-2AC2

6GK5116-0BA00-2AC2

6GK5124-0BA00-2AC2

6EP1332-4BA00

6EP1333-4BA00

6GK5104-0BA00-1SA2

6GK1901-1BB10-2AA0

Article No.

IE FC TP Standard Cable GP 2 x 2 (Type A)

4-wire, shielded TP installation cable for connection to IE FC outlet RJ45/IE FC RJ45 plug; PROFINET-compliant; with UL approval; sold by the meter; max. delivery unit 1 000 m, minimum order quantity 20 m, also available as pre-assembled cable with RJ45 connectors in various lengths

6XV1840-2AH10

FC ST/ BFOC Plug

Screw connector for on-site assembly on FC fiber-optic cable; (1 pack = 10 units + cleaning cloths)

6GK1900-1GB00-0AC0

FO Standard Cable GP 50/125/1400

Multimode cable, sold by the meter; max. delivery unit 1 000 m, minimum order quantity 20 m, also available pre-assembled with ST/BFOC and SC connectors in various lengths

6XV1873-2A

Notes:

- You can find more information on the FastConnect range in the <https://support.industry.siemens.com/cs/document/109766358/ordering-overview-cabling-technology-for-communication-networks-in-industry?dti=0&lc=en-DE> ordering overview
- You can order supplementary components for the SIMATIC NET cabling range from your local contact. Technical advice on this subject is available from:
J. Hertlein
DI PA CI PRM 4
Tel.: +49 (172) 3172810
E-mail: juergen.hertlein@siemens.com

Overview



The managed SCALANCE XB-200 switches are optimized for setting up 10/100 Mbps Industrial Ethernets in line, star or ring topologies

- Electrical and optical nodes or network connections can be implemented using 8 or 16 RJ45 ports (10/100 Mbps) or 3 fiber-optic ports (100 Mbps)
- Rugged plastic enclosure
- Diagnostics on the device by means of LEDs (power, link status, data communication)
- The devices feature SNMP access, integral web server, remote diagnostics, and signaling over the network.
- Diagnostics and parameterization via web page or console port
- Support of the two industrial protocols, PROFINET and Ethernet/IP, in the same device (software-switchable)
- All device versions available with default setting for both PROFINET and EtherNet/IP

Product variants

- Switches with electrical ports:
 - SCALANCE XB208; 8 x 10/100 Mbps RJ45 port, electrical
 - SCALANCE XB216; 16 x 10/100 Mbps RJ45 port, electrical
- Switches with electrical and optical ports
 - SCALANCE XB205-3; 5 x 10/100 Mbps RJ45 port, electrical
3 x 100 Mbps ST/BFOC port, optical
 - SCALANCE XB205-3 LD; 5 x 10/100 Mbps RJ45 port, electrical
3 x 100 Mbps SC port, optical
 - SCALANCE XB213-3; 13 x 10/100 Mbps RJ45 port, electrical
3 x 100 Mbps ST/BFOC port, optical
 - SCALANCE XB213-3 LD; 13 x 10/100 Mbps RJ45 port, electrical
3 x 100 Mbps SC port, optical

Benefits

g e t Designed for Industry

- Ideal solution for configuring Ethernet line, ring and star topologies
- High network availability due to design of redundant ring structures on the basis of high-speed redundancy (HRP) or media redundancy protocol (MRP), redundancy manager integrated
- Quick and easy diagnosis with LEDs on the device, using integral web server and via SNMP
- Integration of the SCALANCE XB-200 switches into existing network management systems, e.g. SINEMA Server or SINEC NMS, by means of SNMP access
- Load limiting when using multicast-based protocols (Voice over IP, Video) thanks to IGMP Snooping/Querier and additional multicast and broadcast limiting per port
- Uncrossed connecting cables can be used due to the integrated autocrossover function
- Support of the two industrial protocols, PROFINET and EtherNet/IP, in the same device
- Low-maintenance operation thanks to fanless construction
- Support of VLANs permits integration into Enterprise Security Policies

Design

The SCALANCE XB-200 Industrial Ethernet switches in their rugged plastic enclosure are optimized for mounting on standard DIN rails.

The devices are designed with IP20 degree of protection.

The switches have a 6-pin terminal block for connecting the redundant supply voltage (24 V DC) and the grounding. The port LEDs provide information on the status (power, link status, data traffic).

Ethernet interfaces:

- 10/100BaseTX, RJ45 connection; 8/6 or 16/13 x RJ45 socket, automatic data transmission rate detection, with autosensing and autocrossover function
- 100 Mbit/s, SC-FO connection; 3 x SC-FO socket (multimode)
- 100 Mbit/s, SC-LD-FO connection; 3 x SC-LD-FO socket (single mode)

Other interfaces:

- 6-pin terminal block for redundant voltage feed (24 V DC) and grounding
- 1 x RJ11 as a connection for the serial interface

The port LEDs provide information on the status (power, link status, data traffic).

Remote diagnosis is possible by means SNMP, web browser and CLI.

SIMATIC PCS 7 system hardware

Industrial communication

Industrial Ethernet

SCALANCE XB-200 switches**Ordering data****Article No.****Article No.****SCALANCE XB-200 Industrial Ethernet Switches**

Industrial Ethernet switches with integral SNMP access, Web diagnostics, copper cable diagnostics, PROFINET and EtherNet/IP support, for configuring line, star and ring topologies; with integrated redundancy manager; includes operating instructions on DVD

SCALANCE XB208

8 x 10/100 Mbps RJ45 ports electrical;

- Default PROFINET settings
- Default Ethernet/IP settings

6GK5208-0BA00-2AB2
6GK5208-0BA00-2TB2

SCALANCE XB205-3

5 x 10/100 Mbps RJ45 ports, electrical,
3 x 100 Mbps BFOC ports, optical (multimode, glass), up to 5 km

- Default PROFINET settings
- Default Ethernet/IP settings

6GK5205-3BB00-2AB2
6GK5205-3BB00-2TB2

SCALANCE XB205-3

5 x 10/100 Mbps RJ45 ports, electrical;
3 x 100 Mbps SC ports, optical (multimode, glass), up to 5 km

- Default PROFINET settings
- Default Ethernet/IP settings

6GK5205-3BD00-2AB2
6GK5205-3BD00-2TB2

SCALANCE XB205-3LD

5 x 10/100 Mbps RJ45 ports, electrical;
3 x 100 Mbps BFOC ports, optical (single-mode, glass), up to 26 km

- Default PROFINET settings
- Default Ethernet/IP settings

6GK5205-3BF00-2AB2
6GK5205-3BF00-2TB2

SCALANCE XB216

16 x 10/100 Mbps RJ45 ports, electrical;

- Default PROFINET settings
- Default Ethernet/IP settings

6GK5216-0BA00-2AB2
6GK5216-0BA00-2TB2

SCALANCE XB213-3

13 x 10/100 Mbps RJ45 ports, electrical;
3 x 100 Mbps BFOC ports, optical (multimode, glass), up to 5 km

- Default PROFINET settings
- Default Ethernet/IP settings

6GK5213-3BB00-2AB2
6GK5213-3BB00-2TB2

SCALANCE XB213-3

13 x 10/100 Mbps RJ45 ports, electrical;

3 x 100 Mbps SC port, optical (multimode, glass), up to 5 km

- Default PROFINET settings
- Default Ethernet/IP settings

6GK5213-3BD00-2AB2
6GK5213-3BD00-2TB2

SCALANCE XB213-3LD

13 x 10/100 Mbps RJ45 ports, electrical;
3 x 100 Mbps BFOC ports, optical (single-mode, glass), up to 26 km

- Default PROFINET settings
- Default Ethernet/IP settings

6GK5213-3BF00-2AB2
6GK5213-3BF00-2TB2

Accessories**SITOP compact 24 V/0.6 A**

Single-phase power supply with wide-range input 85 – 264 V AC/110 – 300 V DC, stabilized output voltage 24 V, rated output current value 0.6 A, slim design

6EP1331-5BA00**LOGO!Power 24 V/1.3 A**

Stabilized power supply
Input: 100-230 V AC (110-300 V DC)
Output: 24 V DC/1.3 A

6EP1331-1SH03**IE TP Cord RJ45/RJ45**

Pre-assembled 8-wire Cat6_A patch cable 4 x 2, with two RJ45 connectors, preferred length

- 0.3 m
- 0.5 m
- 1 m
- 2 m
- 3 m
- 4 m
- 6 m
- 10 m
- 15 m
- 20 m
- 25 m
- 30 m
- 35 m
- 40 m
- 45 m
- 50 m

6XV1870-3QE30
6XV1870-3QE50
6XV1870-3QH10
6XV1870-3QH20
6XV1870-3QH30
6XV1870-3QH40
6XV1870-3QH60
6XV1870-3QN10
6XV1870-3QN15
6XV1870-3QN20
6XV1870-3QN25
6XV1870-3QN30
6XV1870-3QN35
6XV1870-3QN40
6XV1870-3QN45
6XV1870-3QN50

FO Standard Cable GP 50/125/1400

Multimode cable, sold by the meter; max. delivery unit 1 000 m, minimum order quantity 20 m, also available pre-assembled with ST/BFOC and SC connectors in various lengths

6XV1873-2A**SCALANCE TAP104**

Test access port for the reaction-free extraction of Ethernet data frames (10/100 Mbps) from both transmission directions; extracts complete data traffic, including faulty frames, for further diagnostics.

6GK5104-0BA00-1SA2**Notes:**

- You can find more information on the FastConnect range in the <https://support.industry.siemens.com/cs/document/109766358/ordering-overview-cabling-technology-for-communication-networks-in-industry?dti=0&lc=en-DE> ordering overview
- You can order supplementary components for the SIMATIC NET cabling range from your local contact. Technical advice on this subject is available from:
J. Hertlein
DI PA CI PRM 4
Tel.: +49 (172) 3172810
E-mail: juergen.hertlein@siemens.com

Overview

The managed Industrial Ethernet switches of the SCALANCE XC-200 product line are optimized for setting up Industrial Ethernet networks with data transfer rates of 10/100/1 000 Mbps as well as 2 x 10 Gbps (SCALANCE XC206-2G PoE and XC216-3G PoE only) in line, star or ring topologies. More information:

- Rugged enclosure in SIMATIC S7-1500 format, for mounting on standard DIN rails and SIMATIC S7-300 and S7-1500 DIN rails, or for direct wall mounting
- Electrical or optical connection to stations or networks according to port characteristics of the devices
- Versions with transmission rates up to 10 Gbps optical or 1 Gbps electrical
- Combo ports for the flexible use of interfaces: A combo port consists of an electric port and an SFP slot. Only one of the two ports can ever be active. If an SFP plug-in transceiver is inserted, the electric port is deactivated
- Rugged station connections with industry-standard RJ45 connectors that offer additional strain and bending strain relief thanks to latching on the enclosure
- Redundant power supply
- Console port for direct access to device
- Display of comprehensive operating mode and status information via LEDs and selection pushbuttons
- Signaling contact for connecting to an error signaling system
- Slot for optional C-PLUG removable data storage medium for easy device replacement without additional equipment such as a Field PG
- Grounding screw for external ground connection
- Flexible use in the automation environment due to switchover between the two industry protocols PROFINET and EtherNet/IP in the device
- Extensive diagnostics options: Full integration in PROFINET and EtherNet/IP diagnostics, SNMP access, integrated web server and automatic email transmission function for remote diagnostics and signaling via the network
- Integration into the SINEC NMS Network Management System for integrated network diagnostics with central firmware management
- Virtual LANs (VLAN) for easy structuring of large networks into smaller, logical subnetworks. Reasons for the subdivision into logical subnetworks are, for example, separation of the Ethernet networks to reduce the broadcast load, separation of sensitive areas from the main network, and subdivision of the network into logical working groups
- By learning the multicast sources and destinations (IGMP, Internet Group Management Protocol Snooping), SCALANCE XC-200 switches can also filter multicast data traffic and thus limit the load on the network
- Integrated security functions offer protection against unauthorized network access and configuration (e.g. authentication via IEEE 802.1X/ RADIUS)
- The PoE versions support Power over Ethernet (PoE). This allows nodes such as WLAN access points (e.g. SCALANCE W) or cameras (e.g. SIMATIC MV500) to be supplied with power in addition to data. Depending on the version, the PoE switches are supplied with power either via 24 V DC or via 54 V DC.
- A PoE power budget of 120 W is available for the PoE 24 V DC versions. With the 54 V DC versions, a power budget of up to 240 W can be realized using a 54 V DC power supply. The available power budget can be distributed to the PoE ports as required. Up to 30 W power per port according to IEEE802.3at and up to 60 W power according to IEEE802.3bt are supported with 2x PoE ports
- Technical inspectorate certification according to IEC 62443-4-2 for implementing secure system architectures.

SIMATIC PCS 7 system hardware

Industrial communication

Industrial Ethernet

SCALANCE XC-200 switches

Overview (continued)

Product versions

Switches with PROFINET delivery state:

- Switches with electrical ports:
 - [SCALANCE XC208](#);
With 8x RJ45 ports 10/100 Mbps, for mounting in control cabinet
 - [SCALANCE XC208G](#);
With 8x RJ45 ports 10/100/1 000 Mbps, for mounting in control cabinet
 - [SCALANCE XC216](#)
With 16x RJ45 ports 10/100 Mbps, for mounting in the control cabinet
 - [SCALANCE XC224](#);
With 24x RJ45 ports 10/100 Mbps, for mounting in the control cabinet
- Switches with electrical and optical ports:
 - [SCALANCE XC206-2](#)
With 6x RJ45 ports 10/100 Mbps and 2x ST/BFOC ports 100 Mbps
 - [SCALANCE XC206-2](#);
With 6x RJ45 ports 10/100 Mbps and 2x SC ports 100 Mbps
 - [SCALANCE XC206-2SFP](#);
With 6x RJ45 ports 10/100 Mbps and 2x SFP plug-in transceivers with 100 or 1 000 Mbps
 - [SCALANCE XC206-2SFP G](#);
With 6x RJ45 ports 10/100/1 000 Mbps and 2x SFP plug-in transceivers 1 000 Mbps
 - [SCALANCE XC216-4C](#);
With 12x RJ45 ports 10/100 Mbps and 4x Gigabit combo ports (either 10/100/1 000 Mbps RJ45 port or SFP connector 1 000 Mbps can be used)
 - [SCALANCE XC216-4C G](#);
With 12x RJ45 ports 10/100/1 000 Mbps and 4x Gigabit combo ports (either 10/100/1 000 Mbps RJ45 port or SFP plug-in transceiver 1 000 Mbps can be used)
 - [SCALANCE XC224-4C G](#);
With 20x RJ45 ports 10/100/1 000 Mbps and 4x Gigabit combo ports (either 10/100/1 000 Mbps RJ45 port or SFP plug-in transceiver 1 000 Mbps can be used)
- Switches with EtherNet/IP delivery state:
 - [SCALANCE XC206-2SFP G](#);
With 6x RJ45 ports 10/100/1 000 Mbps and 2x SFP plug-in transceivers 1 000 Mbps
 - [SCALANCE XC208G](#);
With 8x RJ45 ports 10/100/1 000 Mbps, for mounting in control cabinet
 - [SCALANCE XC216-4C G](#);
With 12x RJ45 ports 10/100/1 000 Mbps and 4x Gigabit combo ports (either 10/100/1 000 Mbps RJ45 port or SFP plug-in transceiver 1 000 Mbps can be used)
 - [SCALANCE XC224-4C G](#);
With 20x RJ45 ports 10/100/1 000 Mbps and 4x Gigabit combo ports (either 10/100/1 000 Mbps RJ45 port or SFP plug-in transceiver 1 000 Mbps can be used)
- PoE switches with delivery state PROFINET with 24 V DC infeed (PoE power budget 120 W):
 - [SCALANCE XC206-2G PoE](#);
with 2x SFP ports: Support for 1 000 or 10 000 Mbps SCALANCE SFPs and 6x PoE RJ45 ports 10/100/1 000 Mbps, 2x of which up to 60 Watt per PoE port (802.3bt) and 4x of which up to 30 Watt per PoE port (802.3at)
 - [SCALANCE XC208G PoE](#);
with 2x RJ45 10/100/1 000 Mbps and 6x PoE RJ45 ports 10/100/1 000 Mbps, 2x of which up to 60 Watt per PoE port (802.3bt) and 4x of which up to 30 Watt per PoE port (802.3at)
 - [SCALANCE XC216-3G PoE](#);
with 3x SFP ports: 2x support for 1 000 or 10 000 Mbps SCALANCE SFPs and 1x 1 000 Mbps SCALANCE SFP and 2x RJ45 10/100/1 000 Mbps and 14x PoE RJ45 ports 10/100/1 000 Mbps, 2x of which up to 60 watt per PoE port (802.3bt) and 12x of which up to 30 watt per PoE port (802.3at)
- PoE switches with delivery state PROFINET with 54 V DC infeed (PoE power budget: 240 W):
 - [SCALANCE XC206-2G PoE](#);
with 2x SFP ports: Support for 1 000 or 10 000 Mbps SCALANCE SFPs and 6x PoE RJ45 ports 10/100/1 000 Mbps, 2x of which up to 60 Watt per PoE port (802.3bt) and 4x of which up to 30 Watt per PoE port (802.3at)
 - [SCALANCE XC208G PoE](#);
with 2x RJ45 10/100/1 000 Mbps and 6x PoE RJ45 ports 10/100/1 000 Mbps, 2x of which up to 60 Watt per PoE port (802.3bt) and 4x of which up to 30 Watt per PoE port (802.3at)
 - [SCALANCE XC216-3G PoE](#);
with 3x SFP ports: 2x support for 1 000 or 10 000 Mbps SCALANCE SFPs and 1x 1 000 Mbps SCALANCE SFP and 2x RJ45 10/100/1 000 Mbps and 14x PoE RJ45 ports 10/100/1 000 Mbps, 2x of which up to 60 watt per PoE port (802.3bt) and 12x of which up to 30 watt per PoE port (802.3at)

Overview (continued)

Today's portfolio	XC206-2 ST (BFOC)/SC				XC206-2SFP					XC206-2SFP G / XC216-4C G							
	XC-200																
Previous portfolio	X-200 / (X-300)																
	X204-2	X204-2FM	X206-1	X304-2FE	X204-2	X204-2FM	X204-2LD	X206-1	X206-1LD	X306-1LD FE	X307-3	X307-3LD	X308-2	X308-2LD	X308-2LH	X308-2LH+	X308-2M

G_1K10_XX_09821

Migration from SCALANCE X-200/X-300 to the new SCALANCE XC-200 portfolio – Part 1

Current portfolio	XC206-2 G PoE	XC208	XC208G	XC216	XC216-4C G	XC224	XC224-4C G		
	XC-200								
Former portfolio	X-200 / (X-300)								
	X308-2M PoE	X208	X308-2M	X310	X216	X212-2	X212-2LD	X224	X320-1FE

G_1K10_XX_50822

Migration from SCALANCE X-200/X-300 to the new SCALANCE XC-200 portfolio – Part 2

SIMATIC PCS 7 system hardware

Industrial communication

Industrial Ethernet

SCALANCE XC-200 switches

Benefits

g e t Designed for Industry

- Operational reliability in industrial environments, e.g. due to rugged enclosure, redundancy, temperature range from -40 °C to +70 °C
- Increased plant availability thanks to:
 - Redundant power supply
 - Redundant network structures based on fast media redundancy HRP and MRP
 - Standby redundancy between HRP rings
 - Redundant coupling of MRP rings with MRP interconnection
 - Prevention of loops by standard STP, RSTP and MSTP mechanisms, and loop detection
 - Improved reconfiguration times for redundant connection of MRP rings in RSTP networks through RSTP+ function
 - SFP plug-in transceivers can be replaced or expanded during operation
 - easy device replacement by means of plug-in C-PLUG removable data storage medium
 - Link aggregation (IEEE 802.3ad) for parallel use of ports to increase transmission rate failure safety
- Easy monitoring and diagnostics due to separate diagnostics station with integrated LEDs, signaling contact, web browser, traps and email transmission
- Integration into the SINEC NMS network management system for integrated network diagnostics with central firmware management
- Reduced engineering expenditure for PLC/HMI due to integration into the SIMATIC system fault message concept
- Configuration in the TIA Portal as well as in Web Based Management (WBM)
- Easy integration in process and system diagnostics with PROFINET or EtherNet/IP
- Integration of SCALANCE XC-200 switches in existing network management systems, such as SINEC NMS, through SNMP access
- Easy integration in the process and system diagnostics with PROFINET via SIMATIC PCS 7 and PCS neo
- Reliable plug-in connection thanks to rugged, industry-standard device connection in conjunction with industry-standard FastConnect connectors
- Integration of switches through support of S2 system redundancy and H-Sync in SIMATIC S7-1500R/H systems
- Easy and cost-saving supply of connected cameras (e.g. SIMATIC MV500 IP or Ident cameras), WLAN access points (e.g. SCALANCE W) or localization components (e.g. SIMATIC RTLS gateways) with data and power on a single cable by using the PoE standard (Power over Ethernet, PoE versions)
- Optimal use of PoE power budget through PoE Power Management. The available PoE power budget can be distributed by the user to the PoE ports as desired
- Realization of high-performance networks over long distances

Design

SCALANCE XC-200 Industrial Ethernet switches with a rugged enclosure are optimized for mounting on standard DIN rails and SIMATIC S7-1500 mounting rails. Direct wall mounting in various positions and mounting on a SIMATIC S7-300 mounting rail are also possible. Thanks to the SIMATIC S7-1500 enclosure dimensions, the devices are ideally suited for integration into an automation solution with SIMATIC S7-1500 components.

The network access points with IP20 degree of protection feature:

- A 4-pin terminal block (push-in) for connecting the redundant supply voltage (2 x 24 DC)
- The following status information is displayed by LEDs on site:
 - Port status
 - Port mode (10/100/1 000 Mbps, full/half-duplex)
 - Status of the two power supplies
 - Signaling contact status
 - Signal mask (setpoint status)
 - Redundancy manager mode (RM mode)
 - Standby mode
- A 2-pin terminal block (push-in) for connecting the floating signaling contact
- A SELECT/SET key for on-site configuration of the signaling contact

SCALANCE XC-200 switches are available with the following port types:

- [10/100/1000BASETX, RJ45 connection](#); Automatic detection of the data rate (10, 100 or 1 000 Mbps), with autosensing and autocrossover function for connecting IE FC cables via IE FC RJ45 plugs over distances up to 100 m.
- [100BASEFX, ST/BFOC connection system \(SCALANCE XC-206-2\)](#); ST/BFOC ports for direct connection to Industrial Ethernet glass fiber-optic cables up to 5 km (multimode FOC)
- [100BASEFX, SC connection system \(SCALANCE XC-206-2\)](#); SC ports for direct connection to Industrial Ethernet glass fiber-optic cables up to 5 km (multimode FOC)
- [SFP slots for 100BASE-X, 1000BASE-X, 10GBASE-X](#) LC connections with different ranges can be implemented via SFP modules (multimode/single-mode up to 200 km)
- In the PoE versions, the SFP interfaces of the combo ports support both 1 000 Mbps SFPs and 10 000 Mbps SFP+

Ordering data	Article No.	Article No.
<p>SCALANCE XC-200 Industrial Ethernet Switches</p> <p>Industrial Ethernet switches with integrated SNMP access, online diagnostics, copper cable diagnostics and PROFINET diagnostics for configuring line, star and ring topologies; with integrated redundancy manager; incl. operating instructions, Industrial Ethernet network manual and configuration software on CD-ROM</p>		<p>Switches with PROFINET Delivery State (continued)</p> <ul style="list-style-type: none"> • SCALANCE XC216-4C With 12 RJ45 ports 10/100 Mbps • SCALANCE XC216-4C G With 12 RJ45 ports 10/100/1 000 Mbps • SCALANCE XC216-4C G (E/IP Def.) With 12 RJ45 ports 10/100/1 000 Mbps • SCALANCE XC224-4C G With 20 RJ45 ports 10/100/1 000 Mbps • SCALANCE XC224-4C G (E/IP Def.) With 20 RJ45 ports 10/100/1 000 Mbps • SCALANCE XC206-2G PoE with 6 PoE RJ45 ports 10/100/1 000 Mbps and 2 SFP ports (24 V DC) • SCALANCE XC206-2G PoE with 6 PoE RJ45 ports 10/100/1 000 Mbps and 2 SFP ports (54 V DC) • SCALANCE XC208G PoE with 6 PoE RJ45 ports 10/100/1 000 Mbps and 2 RJ45 ports 10/100/1 000 Mbps (24 V) • SCALANCE XC208G PoE (54 V) with 6 PoE RJ45 ports 10/100/1 000 Mbps and 2 RJ45 ports 10/100/1 000 Mbps (54 V) • SCALANCE XC216-3G PoE with 14 PoE RJ45 ports 10/100/1000 Mbps and 2 RJ45 ports 10/100/1000 Mbps • SCALANCE XC216-3G PoE (54 V) with 14 PoE RJ45 ports 10/100/1000 Mbps and 2 RJ45 ports 10/100/1000 Mbps (54 V)
<p>Switches with PROFINET Delivery State</p> <ul style="list-style-type: none"> • SCALANCE XC206-2 (ST/BFOC) With six RJ45 ports 10/100 Mbps and two ST/BFOC ports 100 Mbps • SCALANCE XC206-2 (SC) With six RJ45 ports 10/100 Mbps and two SC ports 100 Mbps • SCALANCE XC206-2SFP With six RJ45 ports 10/100 Mbps and two SFP slots for SFPs with 100 or 1 000 Mbps • SCALANCE XC206-2SFP G With six RJ45 ports 10/100/1 000 Mbps and two SFP slots for SFPs with 1 000 Mbps • SCALANCE XC208 With eight RJ45 ports 10/100 Mbps • SCALANCE XC208G With eight RJ45 ports 10/100/1 000 Mbps • SCALANCE XC216 With 16 RJ45 ports 10/100 Mbps • SCALANCE XC224 With 24 RJ45 ports 10/100 Mbps • SCALANCE XC206-2SFP G With six RJ45 ports 10/100/1 000 Mbps and two SFP slots for SFPs with 1 000 Mbps • SCALANCE XC208G With eight RJ45 ports 10/100/1 000 Mbps 	<p>6GK5206-2BB00-2AC2</p> <p>6GK5206-2BD00-2AC2</p> <p>6GK5206-2BS00-2AC2</p> <p>6GK5206-2GS00-2AC2</p> <p>6GK5208-0BA00-2AC2</p> <p>6GK5208-0GA00-2AC2</p> <p>6GK5216-0BA00-2AC2</p> <p>6GK5224-0BA00-2AC2</p> <p>6GK5206-2GS00-2TC2</p> <p>6GK5208-0GA00-2TC2</p>	<p>6GK5216-4BS00-2AC2</p> <p>6GK5216-4GS00-2AC2</p> <p>6GK5216-4GS00-2TC2</p> <p>6GK5224-4GS00-2AC2</p> <p>6GK5224-4GS00-2TC2</p> <p>6GK5206-2RS00-2AC2</p> <p>6GK5206-2RS00-5AC2</p> <p>6GK5208-0RA00-2AC2</p> <p>6GK5208-0RA00-5AC2</p> <p>6GK5216-3RS00-2AC2</p> <p>6GK5216-3RS00-5AC2</p>

SIMATIC PCS 7 system hardware

Industrial communication

Industrial Ethernet

SCALANCE XC-200 switches

Ordering data	Article No.	Article No.
Accessories		
S7-1500 PM 1507 Power Supply	6EP1333-4BA00	
SIMATIC PM 1507 24 V/8 A Stabilized power supply for SIMATIC S7-1500 Input: 120/230 V AC Output: 24 V DC/8 A		
SITOP PSU100E power supply	6EP3344-0SB00-0AY0	
Stabilized power supply Input: 120 / 230 V AC Output: 48 V DC/5 A		
RUGGEDCOM RPS1300 PoE power supply	6GK6000-8HS01-0AA0	
Stabilized power supply for RUGGEDCOM Power over Ethernet (PoE) Input: 120/230 V AC Output: 54 V DC/2.6 A		
SCALANCE PSR9230 PoE power supply	6GK5923-0PS00-2RA3	
Stabilized power supply for Power over Ethernet (PoE) Input: 230 V AC Output: 54 V DC		
C-PLUG		
Removable data storage medium for simple replacement of devices in the event of a fault; for storing configuration or engineering and application data; can be used in SIMATIC NET products with C-plug slot • 1 pack = 1 unit	6GK1900-0AB10	
IE FC RJ45 PLUG 180 2x2	6GK1901-1BB10-2AA0	
Industrial Ethernet FastConnect RJ45 plug 180 2x2, RJ45 connector (10/100 Mbps) with rugged metal enclosure and FC connection technology, for IE FC cable 2x2 180° cable outlet 1 pack = 1 unit		
IE FC RJ45 plug 4x2	6GK1901-1BB11-2AA0	
RJ45 plug-in data connector (10/100/1 000 Mbps), for connection to IE FC TP cables 4x2, with rugged metal enclosure and FastConnect connection technology		
IE FC TP Standard Cable GP 2 x 2 (Type A)	6XV1840-2AH10	
4-core, shielded TP installation cable for connection to IE FC RJ45 outlet/IE FC RJ45 plug; PROFINET-compliant; with UL approval; sold by the meter; max. delivery unit 1 000 m, minimum order quantity 20 m, also available as pre-assembled cable with RJ45 plugs in various lengths		
IE FC TP Standard Cable GP 4X2	6XV1878-2A	
TP installation cable Cat6 for connecting to IE FC RJ45 plug 4x2, AWG 24, sold by the meter; max. delivery unit 1 000 m, minimum order quantity 20 m, also available pre-assembled with RJ45 plugs in various lengths		
		FO Standard Cable GP 50/125/1400
		Multimode cable, sold by the meter; max. delivery unit 1 000 m, minimum order quantity 20 m, also available pre-assembled with ST/BFOC, SC and LC plugs in various lengths
		Small Form-Factor Pluggable (SFP)
		SFPs with LC plug for use in SCALANCE XC206-2G PoE; glass fiber-optic SFPs in single-mode and multimode, 1 000 or 10 000 Mbps.
		• SFP993-1, 1x 10 Gbps, Multimode
		6GK5993-1AT00-8AA0
		• SFP993-1LD, 1x 10 Gbps, Single-mode
		6GK5993-1AU00-8AA0
		• SFP993-1LH, 1x 10 Gbps, Single-mode
		6GK5993-1AV00-8AA0
		• Pre-assembled IE cable with 2x SFPs, 1 m
		6GK5980-3CB00-0AA1
		• Pre-assembled IE cable with 2x SFPs, 2 m
		6GK5980-3CB00-0AA2
		• Pre-assembled IE cable with 2x SFPs, 3 m
		6GK5980-3CB00-0AA7
		See accessories for SCALANCE XC-200 for further 1 Gbps SFPs https://mall.industry.siemens.com/mall/en/en/Catalog/Products/10350980?tree=CatalogTree
		SCALANCE TAP104
		6GK5104-0BA00-1SA2
		Test access port for the reaction-free extraction of Ethernet data frames (10/100 Mbps) from both transmission directions; extracts complete data traffic, including faulty frames, for further diagnostics.
		Notes:
		• You can find more information on the FastConnect range in the https://support.industry.siemens.com/cs/document/109766358/ordering-overview-cabling-technology-for-communication-networks-in-industry?dti=0&lc=en-DE ordering overview
		• You can order supplementary components for the SIMATIC NET cabling range from your local contact. Technical advice on this subject is available from: J. Hertlein DI PA CI PRM 4 Tel.: +49 (172) 3172810 Email: juergen.hertlein@siemens.com

Overview



The managed Industrial Ethernet switches of the SCALANCE XC-200EEC product line are optimized for setting up Industrial Ethernet networks in process automation with data transfer rates of 10/100/1000 Mbps in line, star or ring topologies. Rugged enclosure in SIMATIC S7-1500 format, for mounting on standard DIN mounting rails and SIMATIC S7-300 and SIMATIC S7-1500 mounting rails, or for direct wall mounting.

- The XC-200EEC versions are optimized for use in process automation and feature the following properties:
 - Conformal coating PCBs
 - Max. installation altitude 4 000 m
 - Extended temperature range from -40 °C to +70 °C
 - NAMUR NE 21-compliant
 - Firmware support for S2 device and CiR/H-CiR
 - Release and integration capability for SIMATIC PCS 7
- Electrical or optical connection to stations or networks according to port characteristics of the devices
- Versions with transmission rates up to 1 000 Mbps, electrical or optical

Product versions

- Switches with electrical ports:
 - SCALANCE XC208 (EEC)
With 8x RJ45 ports 10/100 Mbps for mounting in the control cabinet
 - SCALANCE XC208G (EEC)
With 8x RJ45 ports 10/100/1000 Mbps for mounting in the control cabinet
 - SCALANCE XC216 (EEC)
With 16x RJ45 ports 10/100 Mbps for mounting in the control cabinet
- Switches with electrical and optical ports
 - SCALANCE XC206-2SFP (EEC)
With 6x RJ45 ports 10/100 Mbps and 2x SFP plug-in transceivers with 100 or 1 000 Mbps
 - SCALANCE XC206-2SFP G (EEC)
With 6x RJ45 ports 10/100/1 000 Mbps and 2x SFP plug-in transceivers 1 000 Mbps
 - SCALANCE XC216-4C (EEC)
With 12x RJ45 ports 10/100/1 000 Mbps and 4x Gigabit combo ports (either 10/100/1 000 Mbps RJ45 port or SFP plug-in transceiver 1 000 Mbps can be used)
 - SCALANCE XC224-4C G (EEC)
With 20x RJ45 ports 10/100/1 000 Mbps and 4x Gigabit combo ports (either 10/100/1 000 Mbps RJ45 port or SFP plug-in transceiver 1 000 Mbps can be used)

Benefits

g e t Designed for Industry

- Operational reliability in industrial environments, e.g. due to rugged enclosure, redundancy, temperature range from -40 °C to +70 °C
- Increased plant availability thanks to:
 - Redundant power supply
 - Redundant network structures based on fast media redundancy HRP and MRP
 - Standby redundancy between HRP rings
 - Prevention of loops by standard STP, RSTP and MSTP mechanisms, and loop detection
 - SFP plug-in transceivers can be replaced or expanded during operation
 - Easy device replacement by means of plug-in C-PLUG removable data storage medium
 - Link aggregation (IEEE 802.3ad) for parallel use of ports to increase transmission rate failure safety
- Integration of switches in systems with S2 single system redundancy and Configuration in Run (CiR/H-CiR)
- Since Configuration in Run (CiR/H-CiR) is supported, PROFINET-defined configuration changes to the switch are performed during operation
- Configuration as a service bridge permits dedicated temporary access from the plant bus to the fieldbus for advanced commissioning and diagnostic purposes
- Easy monitoring and diagnostics due to separate diagnostics station with integrated LEDs, signaling contact, web browser, traps and e-mail transmission
- Easy integration in the process and system diagnostics with PROFINET via SIMATIC PCS 7
- Integration of Industrial Ethernet switches into existing network management systems (e.g. SINEMA Server or SINEC NMS) by means of SNMP access
- Reliable plug-in connection thanks to rugged, industry-standard device connection in conjunction with industry-standard FastConnect connectors

Design

SCALANCE XC-200EEC Industrial Ethernet switches with a rugged enclosure are optimized for mounting on standard DIN rails and SIMATIC S7-1500 mounting rails. Direct wall mounting in various positions and mounting on a SIMATIC S7-300 mounting rail are also possible. Thanks to the SIMATIC S7-1500 enclosure dimensions, the devices are ideally suited for integration into an automation solution with SIMATIC S7-1500 components.

The switches with IP20 degree of protection feature:

- A 4-pin terminal block (push-in) for connecting the redundant supply voltage (2 x 24 DC)
- LEDs for signaling on-site status information:
 - Port status
 - Port mode (10/100/1 000 Mbps, full/half-duplex)
 - Status of the two power supplies
 - Signaling contact status
 - Signal mask (setpoint status)
 - Redundancy manager mode (RM mode)
 - Standby mode
- A 2-pin terminal block (push-in) for connecting the floating signaling contact
- A SELECT/SET key for on-site configuration of the signaling contact

SIMATIC PCS 7 system hardware

Industrial communication

Industrial Ethernet

SCALANCE XC-200EEC switches**Design** (continued)

SCALANCE XC-200EEC switches are available with the following port types:

- 10/100/1000BASETX, RJ45 connection; Automatic detection of the data rate (10 or 100 Mbps), with autosensing and autocrossover function for connecting IE FC cables via IE FC RJ45 plugs over distances up to 100 m.
- SFP slots for 100BASE-X, 1000BASE-X, 10GBASE-X LC connections with different ranges can be implemented via SFP modules (multimode/single-mode up to 200 km)
- With SCALANCE XC206-2G PoE EEC, the SFP interfaces of the combo ports support both 1 000 Mbps SFPs and 10 000 Mbps SFP+

Ordering data**Article No.****Article No.****SCALANCE XC-200EEC Industrial Ethernet switches**

Industrial Ethernet switches with integrated SNMP access, online diagnostics, copper cable diagnostics and PROFINET diagnostics for configuring line, star and ring topologies; with integrated redundancy manager; incl. operating instructions, Industrial Ethernet network manual and configuration software on CD-ROM

- **SCALANCE XC206-2SFP (EEC)**
With six RJ45 ports
10/100 Mbps and two SFP slots for SFPs with 100 or 1 000 Mbps; with coated PCBs
- **SCALANCE XC206-2SFP G (EEC)**
With six RJ45 ports
10/100/1 000 Mbps and two SFP slots for SFPs with 1 000 Mbps; with coated PCBs
- **SCALANCE XC208 (EEC)**
With eight RJ45 ports
10/100 Mbps; with coated PCBs
- **SCALANCE XC208G (EEC)**
With eight RJ45 ports
10/100/1000 Mbps; with coated PCBs
- **SCALANCE XC216 (EEC)**
With 16x RJ45 ports 10/100 Mbps; with coated PCBs
- **SCALANCE XC216-4C G (EEC)**
With 12x RJ45 ports
10/100/1000 Mbps; with coated PCBs
- **SCALANCE XC224-4C G (EEC)**
With six RJ45 ports
10/100/1000 Mbps; with coated PCBs

6GK5206-2BS00-2FC2

6GK5206-2GS00-2FC2

6GK5208-0BA00-2FC2

6GK5208-0GA00-2FC2

6GK5216-0BA00-2FC2

6GK5216-4GS00-2FC2

6GK5224-4GS00-2FC2

Accessories**S7-1500 PM 1507 power supply**

6EP1333-4BA00

SIMATIC PM 1507 24 V/8 A
Regulated power supply for SIMATIC S7-1500
Input: 120/230 V AC
Output 24 V DC/8 A

C-PLUG (conformal coating)

C-PLUG removable data storage medium for simple replacement of devices in the event of a fault; for storing configuration or application data; can be used for SIMATIC NET products with C-PLUG slot, conformal coating

- 1 pack = 1 unit

6GK1900-0AQ00

SFP plug-in transceiver

See "Plug-in transceivers for SCALANCE"

IE FC TP standard cable GP 2 x 2 (type A)

6XV1840-2AH10

4-core, shielded TP installation cable for connection to IE FC RJ45 outlet/IE FC RJ45 plug; PROFINET-compliant; with UL approval; Sold by the meter; Max. length 1 000 m, minimum order quantity 20 m, also available as pre-assembled cable with RJ45 connectors in various lengths

IE FC TP standard cable GP 4X2

6XV1878-2A

TP installation cable Cat6 for connecting to IE FC RJ45 plug 4x2, AWG 24
Sold by the meter
Max. length 1 000 m, minimum order quantity 20 m, also available pre-assembled with RJ45 connectors in various lengths

FO standard cable GP 50/125/1400

6XV1873-2A

Multimode cable
Sold by the meter
Max. delivery unit 1000 m; minimum order quantity 20 m, also available pre-assembled with ST/BFOC, SC and LC connectors in various lengths

SCALANCE TAP104

6GK5104-0BA00-1SA2

Test access port for the reaction-free extraction of Ethernet data frames (10/100 Mbps) from both transmission directions; extracts complete data traffic, including faulty frames, for further diagnostics.

Notes:

- You can find more information on the FastConnect range in the <https://support.industry.siemens.com/cs/document/109766358/ordering-overview-cabling-technology-for-communication-networks-in-industry?dti=0&lc=en-DE> ordering overview
- You can order supplementary components for the SIMATIC NET cabling range from your local contact. Technical support on this subject is available from: J. Hertlein
PD PA CI PRM 4
Phone: +49 (911) 750-4465
E-mail: juergen.hertlein@siemens.com

Overview

The managed Industrial Ethernet switches of the SCALANCE XP-200 product line with 8 or 16 Ethernet ports are optimally suited for setting up cabinet-free automation concepts of Industrial Ethernet networks with transmission rates of 10/100/1000 Mbps in a line, star or ring topology.

- Integral redundancy manager for configuration of high availability networks in ring topologies
 - Electric device or network connection
 - Rugged metal enclosure with mounting options on SIMATIC ET 200pro rack, ITEM rail mounting or direct wall mounting
 - Rugged device connections with industrial-strength M12 plug connectors, M12 D-coded for FastEthernet (10/100 Mbps interfaces), M12 X-coded for Gigabit (1000 Mbps interfaces), PROFINET and EtherNet/IP-compliant M12 connection technology (M12 D-coded, M12 X-coded)
 - Redundant power supply (M12, A-coded)
 - Console port (M12, D-coded)
 - Diagnostics on the device by means of prominent LED display with integrated SELECT/SET button (power, link status, data communication, display mode)
 - Integration into the SINEMA Server or SINEC NMS network management system for integrated network diagnostics with central firmware management
 - Error signaling contact with easy adjustment using SELECT/SET button. Configuration storage using the C-PLUG removable data storage medium
 - Grounding screw for external ground connection
 - Virtual Local Area Network (VLAN) port-based, protocol-based and IP-based
 - IGMP snooping and query (use in EtherNet/IP networks)
 - Access Control List (ACL) MAC-based and IP-based
 - Link aggregation
 - Standby observer for HRP
 - IEEE 802.1X (e.g. RADIUS)
 - Rapid Spanning Tree Protocol/Multi Spanning Tree Protocol (RSTP/MSTP)
 - Remote Network Monitoring (RMON)
 - Configuration in the TIA Portal as well as in Web Based Management (WBM)
 - H-Sync for implementation of system redundancy together with a SIMATIC S7-1500R
- The XP-200EEC versions are also optimized for use in process automation and feature the following properties:
 - Conformal coating PCBs
 - Max. installation altitude 4000 m
 - Extended temperature range from -40 °C to +70 °C
 - NAMUR NE 21-compliant
 - Firmware support for S2 device and CiR/H-CiR
 - Release and integration capability for SIMATIC PCS 7

Product variants

For use in PROFINET and EtherNet/IP automation systems, device variants are offered that have a corresponding default setting for the respective automation system. However, the use of a device with a PROFINET or EtherNet/IP default setting is possible in the other network at any time by changing the configuration.

- Switches with PROFINET delivery state
 - **SCALANCE XP208**
With eight electrical ports (10/100 Mbps, M12 D-coded) for mounting outside the control cabinet (IP65)
 - **SCALANCE XP208EEC**
With eight electrical ports (10/100 Mbps, M12 D-coded) for mounting outside the control cabinet (IP65). Equipped with conformal coating PCBs for use with increased environmental requirements, e.g. rail applications (EN 50155/45545)
 - **SCALANCE XP208PoE EEC**
With four electrical ports (10/100 Mbps, M12 D-coded) and four electrical PoE ports (10/100 Mbps M12 D-coded) according to IEEE 802.3at Type 2 for mounting outside the control cabinet (IP65). Equipped with conformal coating PCBs for use where increased environmental requirements prevail, e.g. rail applications (EN 50155/45545)
 - **SCALANCE XP216**
With twelve electrical ports (10/100 Mbps, M12 D-coded) and 4 electrical ports (10/100/1000 Mbps, M12 X-coded) for mounting outside the control cabinet (IP65)
 - **SCALANCE XP216EEC**
With twelve electrical ports (10/100 Mbps, M12 D-coded) and 4 electrical ports (10/100/1000 Mbps, M12 X-coded) for mounting outside the control cabinet (IP65). Equipped with conformal coating PCBs for use where increased environmental requirements prevail, e.g. rail applications (EN 50155/45545)
 - **SCALANCE XP216PoE EEC**
With eight electrical ports (10/100 Mbps, M12 D-coded), six electrical PoE ports (10/100 Mbps, M12 D-coded) according to IEEE 802.3at Type 2, and two electrical PoE ports (10/100/1000 Mbps, M12 X-coded) according to IEEE 802.3at Type 2. The switch can also be operated with only two PoE ports (10/100 Mbps, M12 D-coded) according to IEEE 802.3at Type 2 and two PoE ports (10/100/1000 Mbps, M12 X-coded) according to IEEE 802.3at Type 2. The switch is designed for mounting outside the control cabinet (IP65), and is equipped with conformal coating PCBs for use where increased environmental requirements prevail, e.g. rail applications (EN 50155/45545)
- Switches with EtherNet/IP delivery state
 - **SCALANCE XP208**
With eight electrical ports (10/100 Mbps, M12 D-coded) for mounting outside the control cabinet (IP65)
 - **SCALANCE XP216**
With twelve electrical ports (10/100 Mbps, M12 D-coded) and 4 electrical ports (10/100/1000 Mbps, M12 X-coded) for mounting outside the control cabinet (IP65)

SIMATIC PCS 7 system hardware

Industrial communication

Industrial Ethernet

SCALANCE XP-200 switches

Benefits



- Ideal solution for configuring Industrial Ethernet line, star and ring topologies
- Industrial-grade plug-in connection (10/100 Mbps M12, D-coded and 10/100/1 000 Mbps, X-coded)
- High network availability through configuration of redundant ring topologies (redundancy manager integrated)
- Integration of the SCALANCE XP-200 Industrial Ethernet switches into existing network management systems (e.g. SINEMA Server or SINEC NMS) by means of SNMP access
- Easy integration in the process diagnostics and system diagnostics with PROFINET and EtherNet/IP
- Integrated configuration and diagnostics in STEP 7/TIA Portal bring significant advantages during the engineering, commissioning, and operating phases of a plant
- C-PLUG enables fast device replacement in the event of an error
- H-Sync for implementation of system redundancy together with a SIMATIC S7-1500R
- Integration of switches in systems with simple S2 system redundancy and Configuration in Run (CiR/HCiR)
- Since Configuration in Run (CiR/H-CiR) is supported, PROFINET-defined configuration changes to the switch are performed during operation
- Easy integration in the process and system diagnostics with PROFINET via SIMATIC PCS 7

Design

The SCALANCE XP-200 Industrial Ethernet switches with rugged metal enclosure are optimized for use outside the control cabinet. Mounting options on ET 200pro rack, ITEM rail mounting or direct wall mounting in variety of mounting positions.

The switches with IP65 degree of protection feature:

- Two 4-pin M12 connections (A-coded) for connection of redundant power supply (2 x 24 V DC)
- An LED display for display of status information using SELECT/SET button (power, link status, data traffic, power supply, signaling contact)
- One 2-pin M12 interface (B-coded) for connecting the floating signaling contact
- One 2-pin M12 interface (D-coded) as console access

The SCALANCE XP-200 switches are available with the following port types:

- **10/100 Mbps, M12 connection (D-coded);** automatic detection of the data rate (10 or 100 Mbps), with autosensing and autocrossover function for connection of IE FC cables via IE FC M12 Plug PRO 2x2 up to 100 m.
- **10/100/10000 Mbps, M12 connection (X-coded);** automatic detection of the data rate (10 or 100 or 1000 Mbps), with autosensing and autocrossover function for connection of IE FC cables via IE FC M12 Plug PRO 4x2 up to 100 m.

Ordering data

Article No.

Article No.

SCALANCE XP-200 Industrial Ethernet switches

Industrial Ethernet switches with integrated SNMP access, web diagnostics, copper cable diagnostics and PROFINET diagnostics, for configuration of electrical line, star and ring topologies; with integrated redundancy manager; incl. operating instructions, Industrial Ethernet network manual and configuration software on CD-ROM

- With electrical ports and PROFINET basic setting
 - **SCALANCE XP208**
With eight 10/100 Mbps M12 ports (D-coded)
 - **SCALANCE XP208EEC**
With eight 10/100 Mbps M12 ports (D-coded) with rail approval EN 50155/45545
 - **SCALANCE XP208PoE EEC**
With four 10/100 Mbps M12 ports (D-coded) and four 100/100 Mbps M12 PoE ports (D-coded) with rail approval EN 50155/45545
 - **SCALANCE XP216**
With twelve 10/100 Mbps M12 ports (D-coded) and four 10/100/1 000 Mbps M12 ports (X-coded)
 - **SCALANCE XP216EEC**
With twelve 10/100 Mbps M12 ports (D-coded) and four 10/100/1 000 Mbps M12 ports (X-coded) with rail approval EN 50155/45545
 - **SCALANCE XP216PoE EEC**
With 12 10/100 Mbps RJ45 ports and two fiber-optic cable ports
- With electrical ports and EtherNet/IP basic setting
 - **SCALANCE XP208**
With eight 10/100 Mbps M12 ports (D-coded)
 - **SCALANCE XP216**
With twelve 10/100 Mbps M12 ports (D-coded) and four 10/100/1 000 Mbps M12 ports (X-coded)

6GK5208-0HA00-2AS6

6GK5208-0HA00-2ES6

6GK5208-0UA00-5ES6

6GK5216-0HA00-2AS6

6GK5216-0HA00-2ES6

6GK5216-0UA00-5ES6

6GK5208-0HA00-2TS6

6GK5216-0HA00-2TS6

Accessories
SITOP PSU100P IP67

Stabilized power supply
 Input: 120/230 V AC
 Output: 24 V DC/8 A

6EP1334-7CA00

C-PLUG

Removable data storage medium for simple replacement of devices in the event of a fault; for storing configuration or engineering and application data; can be used in SIMATIC NET products with C-PLUG slot

6GK1900-0AB10

C-PLUG with conformal coating

Removable data storage medium for simple replacement of devices in the event of a fault; for storing configuration or engineering and application data; can be used in SIMATIC NET products with C-PLUG slot

6GK1900-0AQ00

IE connecting cable M12-90/M12-90

Flexible plug-in cable (4-core), pre-assembled with 4-pole M12 plugs (D-coded), 90° cable outlet, for connection of IE devices such as SCALANCE XP-200, ET 200pro and ET 200eco PN, IP65/67

Length:

- 0.3 m
- 0.5 m
- 1 m
- 1.5 m
- 2 m
- 3 m
- 5 m
- 10 m
- 15 m

6XV1870-8GE30
 6XV1870-8GE50
 6XV1870-8GH10
 6XV1870-8GH15
 6XV1870-8GH20
 6XV1870-8GH30
 6XV1870-8GH50
 6XV1870-8GN10
 6XV1870-8GN15

IE TP cord M12-90/M12-90

Pre-assembled IE flexible cable, with 2 M12 connectors (X-coded), 90° cable outlet

Length:

- 0.5 m
- 1 m
- 1.5 m
- 2 m
- 3 m
- 5 m
- 10 m
- 15 m

6XV1878-5GE50
 6XV1878-5GH10
 6XV1878-5GH15
 6XV1878-5GH20
 6XV1878-5GH30
 6XV1878-5GH50
 6XV1878-5GN10
 6XV1878-5GN15

Power connecting cable M12-90/M12-90

Flexible power cable (4-core), pre-assembled with M12 male connector and M12 female connector (A-coded), 90° cable outlet, for supplying SCALANCE XP-200, ET 200pro and ET 200eco PN, IP65/67

Length:

- 0.3 m
- 0.5 m
- 1 m
- 1.5 m
- 2 m
- 3 m
- 5 m
- 10 m
- 15 m

6XV1801-5GE30
 6XV1801-5GE50
 6XV1801-5GH10
 6XV1801-5GH15
 6XV1801-5GH20
 6XV1801-5GH30
 6XV1801-5GH50
 6XV1801-5GN10
 6XV1801-5GN15

SCALANCE TAP104

Test access port for the reaction-free extraction of Ethernet data frames (10/100 Mbps) from both transmission directions; extracts complete data traffic, including faulty frames, for further diagnostics.

6GK5104-0BA00-1SA2

Notes:

- You can find more information on the FastConnect range in the <https://support.industry.siemens.com/cs/document/109766358/ordering-overview-cabling-technology-for-communication-networks-in-industry?dti=0&lc=en-DE> ordering overview
- You can order supplementary components for the SIMATIC NET cabling range from your local contact. Technical advice on this subject is available from:
 J. Hertlein
 PD PA CI PRM 4
 Phone: +49 (911) 750-4465
 Email: juergen.hertlein@siemens.com

SIMATIC PCS 7 system hardware

Industrial communication

Industrial Ethernet

SCALANCE XF-200 switches

Overview



The managed Industrial Ethernet switches of the SCALANCE XF-200 line are optimized for setting up Industrial Ethernet networks at data transfer rates of 10/100 Mbps in a line, star or ring topology.

- Integrated redundancy manager for constructing Fast Ethernet ring topologies with fast media redundancy
- Electrical or optical connection to stations or networks according to port characteristics of the devices
- Enclosure in SIMATIC ET 200S format (slim design) for use in small control boxes
- Rugged station connections with industry-standard RJ45 connectors that offer additional strain and bending strain relief thanks to latching on the enclosure
- PROFINET diagnostics, SNMP access, integrated web server and automatic email transmission function for remote diagnostics and signaling via the network
- Integration into the SINEMA Server or SINEC NMS network management system for integrated network diagnostics with central firmware management

Product variants

- Switches with electrical and optical ports for glass multimode FOC up to 5 km:
 - SCALANCE XF204-2
4 x 10/100 Mbps RJ45 port, electrical
2 x 100 Mbps ST/BFOC port, optical
 - SCALANCE XF206-1
6 x 10/100 Mbps RJ45 port, electrical
1 x 100 Mbps ST/BFOC port, optical
- Switches with electrical ports:
 - SCALANCE XF204;
4 x 10/100 Mbps RJ45 port, electrical
 - SCALANCE XF208;
8 x 10/100 Mbps RJ45 port, electrical

Benefits

g e t Designed for Industry

- Saves space in the control cabinet and uses smaller control boxes due to slim design in the format of the SIMATIC ET 200S distributed I/O
- Simple connection and disconnection of the RJ45 plug by means of easily accessible RJ45 sockets angled downward on the device
- High availability of the network thanks to:
 - Redundant power supply
 - Redundant network structures based on fiber-optic or twisted-pair cables (redundancy manager is integrated)
 - Easy device replacement by means of C-PLUG removable data storage medium
- Lower susceptibility to failure and higher availability of the plant networking due to latching of the RJ45 FastConnect connectors in the sleeve of the RJ45 ports
- Protection of investment through integration into existing network management systems (e.g. SINEMA Server or SINEC NMS) by means of standardized SNMP access
- Time savings during engineering, commissioning and in the operating phase of a plant by using the configuration and diagnostics integrated in STEP 7/TIA Portal
- Integration into the SINEMA Server or SINEC NMS network management system for integrated network diagnostics with central firmware management

Design

The SCALANCE XF-200 managed Industrial Ethernet switches are designed for installation on a standard DIN rail. With their enclosure in SIMATIC ET 200S format (slim design), the devices are optimally suited for integration in automation solutions in small control boxes together with the SIMATIC ET 200S.

The switches with IP20 degree of protection feature:

- A 4-pin terminal block for connecting the redundant supply voltage (2 x 24 V DC)
- A row of LEDs to indicate the status information (power, link status, data traffic, power supply, signaling contact)
- A 2-pin terminal block for connecting the floating signaling contact
- A SET button for on-site configuration of the signaling contact

The SCALANCE XF-200 switches are available with the following port types:

- 10/100BaseTX, RJ45 connection;
RJ45 socket, automatic detection of the data rate (10 or 100 Mbps), with autosensing and autocrossover functions for connecting IE FC cables using the IE FC RJ45 Plug 180.
- 100BaseFX, ST/BFOC connection technology;
ST/BFOC sockets for direct connection to Industrial Ethernet glass fiber-optic cables up to 5 km (multimode FOC) for configuring line, ring, and star topologies.

Ordering data	Article No.	Article No.
SCALANCE XF-200 Industrial Ethernet Switches Industrial Ethernet switches with integrated SNMP access, online diagnostics, copper cable diagnostics and PROFINET diagnostics for configuring line, star and ring topologies; with integrated redundancy manager; incl. operating instructions, Industrial Ethernet network manual and configuration software on CD-ROM <ul style="list-style-type: none"> • SCALANCE XF204-2 4 x 10/100 Mbps RJ45 ports, electrical; 2 x 100 Mbps BFOC ports, optical (multimode, glass), up to 5 km • SCALANCE XF206-1 6 x 10/100 Mbps RJ45 ports, electrical; 1 x 100 Mbps BFOC ports, optical (multimode, glass), up to 5 km • SCALANCE XF204 4 x 10/100 Mbps RJ45 ports, electrical • SCALANCE XF208 8 x 10/100 Mbps RJ45 ports, electrical 	6GK5204-2BC00-2AF2 6GK5206-1BC00-2AF2 6GK5204-0BA00-2AF2 6GK5208-0BA00-2AF2	IE FC TP Standard Cable GP 2 x 2 (Type A) 4-wire, shielded TP installation cable for connection to IE FC outlet RJ45/IE FC RJ45 plug; PROFINET-compliant; with UL approval; sold by the meter; max. delivery unit 1 000 m, minimum order quantity 20 m, also available as pre-assembled cable with RJ45 connectors in various lengths FO Standard Cable GP 50/125/1400 Multimode cable, sold by the meter; max. delivery unit 1 000 m, minimum order quantity 20 m, also available pre-assembled with ST/BFOC and SC connectors in various lengths SCALANCE TAP104 Test access port for the reaction-free extraction of Ethernet data frames (10/100 Mbps) from both transmission directions; extracts complete data traffic, including faulty frames, for further diagnostics.
Accessories SIMATIC ET 200SP PS 24 V/5 A Stabilized power supply Input: 120/230 V AC Output: 24 V DC/5 A	6EP7133-6AB00-0BN0	6XV1840-2AH10 6XV1873-2A 6GK5104-0BA00-1SA2
C-PLUG Removable data storage medium for simple replacement of devices in the event of a fault; for storing configuration or engineering and application data; can be used in SIMATIC NET products with C-PLUG slot	6GK1900-0AB00	
IE FC RJ45 Plug 180 2 x 2 RJ45 plug-in connector for Industrial Ethernet with a rugged metal enclosure and integrated insulation displacement contacts for connecting Industrial Ethernet FC installation cables; with 180° cable outlet; for network components and CPs/CPUs with Industrial Ethernet interface <ul style="list-style-type: none"> • 1 pack = 1 unit 	6GK1901-1BB10-2AA0	

Notes:

- You can find more information on the FastConnect range in the <https://support.industry.siemens.com/cs/document/109766358/ordering-overview-cabling-technology-for-communication-networks-in-industry?dti=0&lc=en-DE> ordering overview
- You can order supplementary components for the SIMATIC NET cabling range from your local contact. Technical advice on this subject is available from:
J. Hertlein
DI PA CI PRM 4
Tel.: +49 (172) 3172810
E-mail: juergen.hertlein@siemens.com

SIMATIC PCS 7 system hardware

Industrial communication

Industrial Ethernet

SCALANCE XF-200BA switches

Overview



The SCALANCE XF204-2BA from Siemens is a new compact switch in SIMATIC ET 200SP design for factory automation and process automation. It fulfills the recommendations of NAMUR NE 21, and is therefore suitable for use in process automation. The flexible use of various BusAdapters allows support of electrical as well as optical line, star and ring topologies.

- XF-200BA versions are optimized for use in process automation and feature the following properties:
 - Conformal coating PCBs
 - Max. installation altitude 4000 m
 - Extended temperature range from -40 °C to +70 °C
 - NAMUR NE 21-compliant
 - Firmware support for S2 device and CiR/H-CiR
 - Release and integration capability in SIMATIC PCS 7 and PCS neo
- Connection of up to two modular BusAdapters (2 ports each) supported
- Enclosure in SIMATIC ET 200SP design (slim design, 100 mm wide) for space-saving use in small control boxes
- Integrated redundancy manager for configuring Fast Ethernet ring topologies with fast MRP media redundancy
- End-to-end system diagnostics with PROFINET, SNMP access, integrated web server, SINEMA Server or SINEC NMS and automatic email transmission function for remote diagnostics and signaling via the network
- H-Sync for implementation of system redundancy together with a SIMATIC S7-1500R

The following BusAdapters are currently released for use with SCALANCE XF204-2BA (others available soon):

- SIMATIC ET 200SP HA, BusAdapter BA 2xRJ45, 2 RJ45 sockets
- SIMATIC ET 200SP HA, BusAdapter BA 2xFC, 2 FastConnect connections
- SIMATIC ET 200SP, BusAdapter BA 2xSCRJ, 2 SCRJ FO connections
- SIMATIC BA 2xRJ45VD HA, 2 RJ45 sockets with VD technology (variable distance)
- SIMATIC ET 200SP, BusAdapter BA 2XRJ45, 2x RJ45 sockets
- SIMATIC ET 200SP, BusAdapter BA 2xFC, 2x FastConnect connections
- SIMATIC ET 200SP, BusAdapter BA SCRJ/RJ45, 1x SCRJ FO connection and 1x RJ45 connection
- SIMATIC ET 200SP, BusAdapter BA SCRJ/FC, 1x SCRJ FO connection and 1x FastConnect (FC) connection
- SIMATIC ET 200SP, BusAdapter BA 2xLC (as of function status 05), 2x LC FO connection, (as of function status 05)
- SIMATIC ET 200SP, BusAdapter BA LC/RJ45, 1x RJ45, 1x LC FO connection, (as of function status 05)
- SIMATIC ET 200SP, BusAdapter BA LC/FC, 1x RJ45 FastConnect, 1x LC FO connection, (as of function status 05)
- ET 200SP HA, BusAdapter, BA 2XLC, 2x LC FO connection, (as of function status 05)

Product variant

SCALANCE XF204-2BA

- The flexible use of various BusAdapters allows users to set up electrical and optical line, star and ring topologies with the SCALANCE XF204-2BA.

Benefits



- Setup of networks in SIMATIC PCS 7/neo systems with extended environmental conditions (conformal coating)
- Small frame size (SIMATIC ET 200SP design and BusAdapter concept)
- Simple, flexible integration into automation solutions through large selection of different BusAdapters
- Modular design with BusAdapters allows efficient spare part storage by using the same BusAdapter in multiple devices
- Approvals for ATEX Zone 2/IECEX, cULus HazLoc, FM, thus use in Zone 2 hazardous areas possible
- Conforms to NAMUR NE 21, integration in all conventional process control systems, such as SIMATIC PCS 7 and PCS neo
- Time savings during engineering, commissioning and in the operating phase of a plant by using the configuration and diagnostics integrated in STEP 7/TIA Portal
- Integration into the SINEMA Server or SINEC NMS network management system for integrated network diagnostics with central firmware management
- H-Sync for implementation of system redundancy together with a SIMATIC S7-1500R
- The SIMATIC BA 2xRJ45VD HA permits PROFINET communication up to 500 m
- Integration of switches in systems with simple S2 system redundancy and Configuration in Run (CiR/HCiR)
- Since Configuration in Run (CiR/H-CiR) is supported, PROFINET-defined configuration changes to the switch are performed during operation
- Easy integration in the process and system diagnostics with PROFINET via SIMATIC PCS 7 and PCS neo

Design

The SCALANCE XF204-2BA managed Industrial Ethernet switch is designed for mounting on a standard DIN rail. With its enclosure in SIMATIC ET 200SP format (slim design), the device is optimally suited for integration in automation solutions in small control boxes together with the SIMATIC ET 200SP.

The SCALANCE XF204-2BA switch with its rugged plastic enclosure and IP20 degree of protection is optimized for mounting on standard DIN rails. Thanks to the dimensions of the SIMATIC ET 200SP enclosure, the devices are ideally suited for integration into an automation solution with SIMATIC ET 200SP components.

The SCALANCE XF204-2BA switch is available with the following port types/interfaces:

- Variant with 2 BusAdapter interfaces
- Variant with two premounted BusAdapters BA 2xRJ45 HA

SIMATIC PCS 7 system hardware

Industrial communication

Industrial Ethernet

SCALANCE XF-200BA switches

Ordering data

SCALANCE XF-204-2BA Industrial Ethernet switches

Managed switch with
2 x BusAdapter interfaces,
24 V DC redundant power supply,
PN device, extended temperature
range, conformal coating,
configuration software on CD-ROM

• SCALANCE XF204-2BA

4 x 10/100 Mbps,
2 x BusAdapter interface,
fault signaling contact,
Set button, redundant 24 V DC
power supply, PROFINET device,
extended temperature range
-40°C ... +70°C, conformal
coating, with electronic manual
on DVD, C-PLUG optional,
supplied without BusAdapter

6GK5204-2AA00-2GF2

• SCALANCE XF204-2BA

two BA 2xRJ45 HA
BusAdapters premounted
6DL1193-6AR00-0AA0,
4 x 10/100 Mbps,
2 x BusAdapter interface,
fault signaling contact,
Set button, redundant 24 V DC
power supply, PROFINET device,
extended temperature range
-40°C ... +70°C, conformal
coating, with electronic manual
on DVD, C-PLUG optional,
supplied with BusAdapter

6GK5204-0BA00-2GF2

Accessories

SIMATIC ET 200SP PS 24 V/5 A

Stabilized power supply
Input: 120/230 V AC
Output: 24 V DC/5 A

6EP7133-6AB00-0BN0

SIMATIC ET 200SP HA, BusAdapter BA 2xRJ45, 2 RJ45 sockets

PROFINET BusAdapter with
Ethernet socket for standard RJ45
plug, with conformal coating PCBs

6DL1193-6AR00-0AA0

SIMATIC ET 200SP HA, BusAdapter BA 2xFC, 2 FastConnect connections

PROFINET BusAdapter with
FastConnect Ethernet connection
for direct bus cable connection,
with conformal coating PCBs

6DL1193-6AF00-0AA0

BusAdapter BA 2xRJ45VD HA

BusAdapter with coated PCBs
(conformal coating) and VD
technology for connecting 2,
4 and 8-wire cables via standard
RJ45 plugs

6GK5991-2VA00-8AA2

ET 200SP, BusAdapter BA 2xSCRJ

SIMATIC ET 200SP, BusAdapter BA
2xSCRJ, 2 SCRJ FO connections
for PROFINET

6ES7193-6AP00-0AA0

ET 200SP, BusAdapter BA SCRJ/RJ45

SIMATIC ET 200SP, BusAdapter BA
SCRJ/RJ45, media converter FOC-CU
1x SCRJ FO connection and
1x RJ45 connection for PROFINET

6ES7193-6AP20-0AA0

ET 200SP, BusAdapter BA SCRJ/FC

SIMATIC ET 200SP, BusAdapter:
BA SCRJ/FC, media converter
FOC-CU 1x SCRJ FO connection
and 1x FastConnect (FC)
connection for PROFINET

6ES7193-6AP40-0AA0

C-PLUG (CONFORMAL COATING)

C-PLUG removable data storage
medium for simple replacement of
devices in the event of a fault; for
storing configuration or application
data; can be used for SIMATIC NET
products with C-PLUG slot,
conformal coating

6GK1900-0AQ00

IE TP Cord RJ45/RJ45

Pre-assembled 8-wire Cat6A patch
cable 4 x 2, with two RJ45 plugs,
preferred length

- 0.3 m
- 0.5 m
- 1 m
- 2 m
- 3 m
- 4 m
- 6 m
- 10 m
- 15 m
- 20 m
- 25 m
- 30 m
- 35 m
- 40 m
- 45 m
- 50 m

6XV1870-3QE30
6XV1870-3QE50
6XV1870-3QH10
6XV1870-3QH20
6XV1870-3QH30
6XV1870-3QH40
6XV1870-3QH60
6XV1870-3QN10
6XV1870-3QN15
6XV1870-3QN20
6XV1870-3QN25
6XV1870-3QN30
6XV1870-3QN35
6XV1870-3QN40
6XV1870-3QN45
6XV1870-3QN50

FO Standard Cable GP 50/125/1400

Multimode cable,
sold by the meter;
max. delivery unit 1 000 m,
minimum order quantity 20 m,
also available pre-assembled
with LC plugs in various lengths

6XV1873-2A

SCALANCE TAP104

Test access port for the reaction-
free extraction of Ethernet data
frames (10/100 Mbps) from both
transmission directions;
extracts complete data traffic,
including faulty frames,
for further diagnostics.

6GK5104-0BA00-1SA2

Notes:

- You can find more information on the FastConnect range in the <https://support.industry.siemens.com/cs/document/109766358/ordering-overview-cabling-technology-for-communication-networks-in-industry?dti=0&lc=en-DE> ordering overview
- You can order supplementary components for the SIMATIC NET cabling range from your local contact. Technical advice on this subject is available from:
J. Hertlein
DI PA CI PRM 4
Tel.: +49 (172) 3172810
Email: juergen.hertlein@siemens.com

Overview

With the SIMATIC BA 2xRJ45VD HA, Siemens provides a new BusAdapter which is designed for variable distances and optimized for the process industry. Depending on the line type, distances of up to 1000 m are achieved with transfer rates of 10 Mbps and up to 500 m with 100 Mbps. This product can be used in several basic units with a BusAdapter interface thanks to the flexible BusAdapter concept. The release of the BusAdapter in the firmware of the basic unit is required.

- The BusAdapter has two 10/100 Mbps RJ45 ports
- Enclosure in the SIMATIC ET 200SP BusAdapter design

Currently, the SIMATIC BA 2xRJ45VD HA can be used with the following basic unit:

- SCALANCE XF204-2BA
- SCALANCE XF204-2BA DNA

Further basic units will follow. The release of the BusAdapter in the firmware (FW) of the basic unit is required.

Benefits

get Designed for Industry

- Reuse of installed PROFIBUS cables for Ethernet transfer via 2 wires
- 10 Mbps up to 1000 m (via 2 wires)
- 100 Mbps up to 100 m (via 2 wires)
- 100 Mbps up to 300 m (via 4 wires)
- 100 Mbps up to 500 m (via 8 wires)
- SIMATIC ET 200SP BusAdapter concept
- Setup of networks in PCS 7 systems with extended ambient conditions (conformal coating)
- Simple, flexible integration into automation solutions
- Approvals for ATEX Zone 2 / IECEx, cULus HazLoc, FM, thus use in Zone 2 hazardous areas possible
- Integration in all conventional process control systems, such as SIMATIC PCS 7

Design

- Technical setup in the SIMATIC ET 200SP design
- The BusAdapter has two RJ45 ports

Ordering data
Article No.
**Industrial Ethernet/PROFINET
BusAdapter BA 2xRJ45VD HA**

BusAdapter BA 2xRJ45VD HA for Ethernet communication via 2, 4 or 8-wire copper cables; 2xRJ45 sockets for Industrial Ethernet and PROFINET; Conformal Coating; -40 °C...+70 °C; installation altitude up to 4000 m; distances up to 1000 m at 10 Mbps; 4-wire up to 300 m at 100 Mbps; 8-wire up to 500 m at 100 Mbps.

- **BusAdapter BA 2xRJ45VD HA**
2 x 10/100 Mbps RJ45 ports, electrical

6GK5991-2VA00-8AA2
Accessories
IE FC RJ45 plug 180 2 x 2

Industrial Ethernet FastConnect RJ45 plug 180 2x2, RJ45 plug-in connector (10/100 Mbps), with rugged metal enclosure and FC connection technology, for IE FC cable 2x2; 180° cable outlet

- 1 pack = 1 unit

6GK1901-1BB10-2AA0
IE FC RJ45 plug 4x2

Industrial Ethernet FastConnect RJ45 plug 180 4x2, RJ45 connector (10/100/1000/10000 Mbps), CAT6A, AWG24, with rugged metal enclosure and FC connection technology, for IE FC cable 4x2; 180° cable outlet

- 1 pack = 1 unit

6GK1901-1BB12-2AA0
IE FC TP cable 2x2

Industrial Ethernet FC TP standard cable, GP 2x2 (PROFINET type A), TP installation cable for connection to IE FC RJ45 2x2, for universal use, 4-wire, shielded CAT 5E, sold by the meter, delivery unit maximum length of 2000 m, minimum order length 20 m

6XV1840-2AH10
IE FC TP Cable GP 4 x 2

Industrial Ethernet FastConnect TP standard cable GP 4x2, TP installation cable CAT6A for connecting to IE FC RJ45 plug 4x2, AWG24, sold by the meter, max. delivery unit 1000 m, minimum order quantity 20 m

6XV1878-2A
PB FC standard cable GP

Standard bus cable, with special design for fast assembly for permanent installation, sold by the meter, max. delivery unit 1000 m, minimum order quantity 20 m

6XV1830-0EH10

SIMATIC PCS 7 system hardware

Industrial communication

Industrial Ethernet

SCALANCE X-200RNA switches

Overview



SCALANCE X-204RNA for HSR (High-availability Seamless Redundancy Protocol in accordance with IEC 62439-3) and PRP (Parallel Redundancy Protocol in accordance with IEC 62439-3)

HSR

The SCALANCE X-200RNA (**R**edundant **N**etwork **A**ccess) managed Industrial Ethernet network access points with HSR functionality are used to connect up to two non-HSR-enabled terminal devices or network segments to a ring-shaped HSR network structure. They can also be used for simple and redundant transition from HSR to PRP (Parallel Redundancy Protocol) network structures.

- Media redundancy thanks to duplicate transmission of frames in ring-shaped networks
- High system availability since frames are sent simultaneously via two routes in the ring
- No reconfiguration times of the ring-shaped network are required in the event of an error due to duplicate transmission of frames in the ring
- Simple and redundant connection of HSR and PRP network structures

PRP

The SCALANCE X-200RNA (**R**edundant **N**etwork **A**ccess) managed Industrial Ethernet network access points with PRP functionality are used to connect up to two non-PRP-enabled terminal devices or network segments to parallel networks.

- Media redundancy thanks to duplicate transmission of frames in two parallel, separate networks
- High system availability since frames are sent simultaneously over two separate networks
- Reconfiguration times in a subnetwork do not affect the propagation time because the frames are transmitted via two separate networks (bumpless redundancy)

Product variants

- Network access point in plastic enclosure with electrical ports
 - SCALANCE X204RNA for HSR or PRP networks
 - For connecting up to two non-HSR- or PRP-enabled terminal devices to ring-shaped networks with four electrical ports
- Network access point in metal enclosure with electrical and optical ports as well as a wide-range power supply unit for use in expanded environmental conditions
 - SCALANCE X204RNA EEC for HSR or PRP networks
 - For connecting up to two non-HSR- or PRP-enabled terminal devices to ring-shaped networks with two electrical terminal device ports and two optical/electrical combo ports for network connection
 - SCALANCE X204RNA EEC for PRP or HSR networks
 - For connecting up to two non-PRP-enabled or non-HSR-enabled terminal devices to redundant networks with two electrical terminal device ports and two optical/electrical combo ports for network connection. PRP or HSR function can be defined by the user when starting the device (for description of PRP function, see chapter on X204RNA with PRP function).
- Redundant 24 V DC voltage infeed or wide-range power supply unit, depending on device version
- SNMP access, integrated web server and automatic email transmission function for remote diagnostics and signaling via the network
- Integration into the SINEMA Server or SINEC NMS network management system for integrated network diagnostics with central firmware management

Benefits



- Ideal solution for establishing Industrial Ethernet networks with high network availability
- HSR: Bumpless data transmission in ring-shaped network structures for high availability systems (e.g. process automation)
- PRP: Bumpless data transmission in parallel network structures for high availability systems
- Quick and easy diagnostics with LEDs on the device, using integral web server, via SINEMA Servers or SINEC NMS and via signaling contacts
- Integration of the SCALANCE X-200RNA network access points into existing network management systems (e.g. SINEMA Server or SINEC NMS) by means of SNMP access
- Simple commissioning without mandatory configuring
- Module replacement without the need for a programming device, using the C-PLUG removable data storage medium for backing up the configuration data

Design

The SCALANCE X204RNA and X204RNA EEC network access points with rugged plastic or metal enclosures have been optimized for installation on a standard mounting rail and for direct wall mounting in different mounting positions.

The network access points with IP20 degree of protection feature:

- A 4-pin terminal block for connecting the redundant supply voltage (2 x 24 V DC), or a 3-pin terminal block in the case of the wide-range power supply unit
- A row of LEDs to indicate the status information (power, link status, data traffic, power supply, signaling contact)
- A 2-pin or 3-pin terminal block for connecting the floating signaling contact in the corresponding voltage range
- A SET button for on-site configuration of the signaling contact

The SCALANCE X-200RNA modules are available with the following port types:

- **100BaseTX, RJ45 connection:**
RJ45 port with a data rate of 100 Mbps, with autosensing and autocrossover function for the connection of IE FC cables via IE FC RJ45 Plug 180 up to 100 m
- **100BaseTX, combo port (RJ45, SFP slot):**
100 Mbps combo ports for direct connection to Industrial Ethernet copper cables or glass fiber-optic cables (multimode/singlemode fiber-optic cable); if the RJ45 interface of the combo port is used, the SFP slot is deactivated, and vice versa.

SIMATIC PCS 7 system hardware

Industrial communication

Industrial Ethernet

SCALANCE X-200RNA switches

Ordering data

Article No.

SCALANCE X-200RNA managed Industrial Ethernet network access points

Industrial Ethernet network access points with integrated SNMP access, web diagnostics and PROFINET diagnostics; incl. operating instructions, Industrial Ethernet network manual and configuration software on CD ROM; with electrical and optical ports for glass multimode fiber optic cables up to 5 km

HSR;

for connecting non-HSR-enabled terminal devices to ring-shaped HSR networks

- **SCALANCE X204RNA** with four 100 Mbps RJ45 ports
- **SCALANCE X204RNA EEC** with two 100 Mbps RJ45 ports and two RJ45/SFP combo ports
- **SCALANCE X204RNA EEC** with two 100 Mbps RJ45 ports and two RJ45/SFP combo ports with PRP or HSR support

PRP;

for connection of non-PRP-enabled terminal devices to PRP networks

- **SCALANCE X204RNA** with four 100 Mbps RJ45 ports
- **SCALANCE X204RNA EEC** with two 100 Mbps RJ45 ports and two RJ45/SFP combo ports
- **SCALANCE X204RNA EEC** with two 100 Mbps RJ45 ports and two RJ45/SFP combo ports with PRP and HSR support

SIMATIC NET communications processor CP 443-1 RNA

S7 integration into bumpless, redundant network structures on the basis of the Parallel Redundancy Protocol (PRP)

SOFTNET-IE RNA

Software for connecting PCs to PRP-enabled networks with integrated SNMP, runtime software, software and electronic manual on CD-ROM, license key on USB flash drive, Class A

SOFTNET-IE RNA V12

For 32/64-bit Windows 7 Professional/Ultimate; for Windows 2008 Server R2; for 32/64-bit Windows 8 Professional/Enterprise; for Windows Server 2012 German/English

- Single license for one installation

SOFTNET-IE RNA V8.1

For 32-bit Windows XP; German/English

- Single license for one installation

Software Update Service

For one year with automatic extension; requirement: current software version

6GK5204-0BA00-2MB2

6GK5204-0BS00-2NA3

6GK5204-0BS00-3PA3

6GK5204-0BA00-2KB2

6GK5204-0BS00-3LA3

6GK5204-0BS00-3PA3

6GK7443-1RX00-0XE0

6GK1711-1EW12-0AA0

6GK1711-1EW08-1AA0

6GK1711-1EW00-3AL0

Article No.

Accessories**SITOP compact 24 V/0.6 A**

Single-phase power supply with wide-range input 85 – 264 V AC/110 – 300 V DC, stabilized output voltage 24 V, rated output current value 0.6 A, slim design

C-PLUG

Data storage medium for simple replacement of devices in the event of a fault; for storing configuration or engineering and application data; can be used for SIMATIC NET products with C-PLUG slot

SFP Plug-in Transceiver

- SFP991-1 (multimode, glass, up to 3 km)
- SFP991-1LH+ (single-mode, glass, up to 70 km, LH+)
- SFP991-1LD (single-mode, glass, up to 26 km)
- SFP991-1ELH200 (single-mode, glass up to 200 km)

IE TP Cord RJ45/RJ45

Pre-assembled 8-wire Cat6_A patch cable 4 x 2, with two RJ45 connectors, preferred length

- 0.3 m
- 0.5 m
- 1 m
- 2 m
- 3 m
- 4 m
- 6 m
- 10 m
- 15 m
- 20 m
- 25 m
- 30 m
- 35 m
- 40 m
- 45 m
- 50 m

FO Standard Cable GP 50/125/1400

Multimode cable, sold by the meter; max. delivery unit 1 000 m, minimum order quantity 20 m, also available pre-assembled with LC connectors in various lengths

SCALANCE TAP104

Test access port for the reaction-free extraction of Ethernet data frames (10/100 Mbps) from both transmission directions; extracts complete data traffic, including faulty frames, for further diagnostics.

6EP1331-5BA00

6GK1900-0AB00

6GK5991-1AD00-8AA0

6GK5991-1AE00-8AA0

6GK5991-1AF00-8AA0

6GK5991-1AE30-8AA0

6XV1870-3QE30

6XV1870-3QE50

6XV1870-3QH10

6XV1870-3QH20

6XV1870-3QH30

6XV1870-3QH40

6XV1870-3QH60

6XV1870-3QN10

6XV1870-3QN15

6XV1870-3QN20

6XV1870-3QN25

6XV1870-3QN30

6XV1870-3QN35

6XV1870-3QN40

6XV1870-3QN45

6XV1870-3QN50

6XV1873-2A

6GK5104-0BA00-1SA2

Notes:

- You can find more information on the FastConnect range in the <https://support.industry.siemens.com/cs/document/109766358/ordering-overview-cabling-technology-for-communication-networks-in-industry?dti=0&lc=en-DE> ordering overview
- You can order supplementary components for the SIMATIC NET cabling range from your local contact. Technical advice on this subject is available from: J. Hertlein
DI PA CI PRM 4
Tel.: +49 (172) 3172810
E-mail: juergen.hertlein@siemens.com

Overview



The RUGGEDCOM RSG907R and RSG909R are compact Gigabit IEEE 1588 compatible Ethernet switches supporting High Availability Seamless Redundancy (HSR) and Parallel Redundancy Protocol (PRP) according to IEC 62439-3. The RSG907R supports 3 RNA (Redundant Network Access) ports (SFP) and 4 SAN (Singly Attached Node) fiber optic ports (LC). The RSG909R supports 3 RNA ports (SFP) and 6 SAN copper ports (RJ45).

Functions

- Support of HSR and PRP according to IEC 62439-3
- 3 x RNA Ethernet ports according to IEC 62439-3 (1000BASE-X)
- 4 Fiber optic (100BASE-FX, LC) or 6 Copper (10/100/1000BASE-X, RJ45) SAN ports
- Industry standard connectors: SFP, LC and/or RJ45
- Fully integrated power supply with redundant power inputso
 - Universal high-voltage dual inputs: 100 VAC – 240 VAC / 100 VDC – 300 VDC
 - Universal low-voltage DC dual inputs with nominal voltages: 12 VDC, 24 VDC, 48 VDC (10 – 60 VDC)
- Supports precision timing according to IEEE 1588 (transparent clock, ordinary clock)
- Non-blocking store and forward switching
- For use at ambient temperatures from –40 °C to +85 °C without the use of fans

Product versions

RUGGEDCOM RSG907R

A 7-port compact high density switch with 3 RNA ports supporting HSR and PRP according to IEC 62439-3 and 4 SAN fiber optic ports.

RUGGEDCOM RSG909R

A 9 port compact high density switch with 3 RNA ports supporting HSR and PRP according to IEC 62439-3 and 6 SAN copper ports.

Benefits

- Avoid revenue loss by mitigating the risk of communication disruptions and downtime with a redundant fault tolerant network supporting HSR and/o PRP.
- SFP ports allow for in-field modification at any time allowing deployment flexibility for varying customer needs.
- The redundant power supply inputs allow for continuous safe and reliable operations even during single power supply failures, diminishing the risk of revenue and data loss.
- Reduce maintenance costs by combining precision timing information and data communications onto a single network due to the support of IEEE 1588.

SIMATIC PCS 7 system hardware

Industrial communication

Industrial Ethernet

RUGGEDCOM compact switch RNA > RUGGEDCOM RSG900R managed

Ordering data	Article No.	Article No.	
RUGGEDCOM RSG907R RUGGEDCOM RSG907R is a 7 port industrially hardened, fully managed Ethernet switch featuring an integrated HSR/PRP RedBox for use in harsh industrial environments. The product has 3x 1 Gbit/s SFP slots and 4x 100 Mbit/s multimode LC ports (max 2 km). -40 °C to +85 °C operating temperature (fanless).			
<ul style="list-style-type: none"> RUGGEDCOM RSG907R 	6GK6490-7RB...-....		
RUGGEDCOM RSG909R RUGGEDCOM RSG909R is a 9 port industrially hardened, fully managed Ethernet switch featuring an integrated HSR/PRP RedBox for use in harsh industrial environments. The product has 3x 1 Gbit/s SFP slots and 6x 10/100/1000 Mbit/s RJ45 Ethernet ports. -40 °C to +85 °C operating temperature (fanless).			
<ul style="list-style-type: none"> RUGGEDCOM RSG909R 	6GK6498-0RB...-....		
RUGGEDCOM accessories			
<ul style="list-style-type: none"> USB Console cable USB 2.0 A type to B type Cable Assembly 10 feet / 3 meters 	6GK6000-8DT01-0AA0		
<ul style="list-style-type: none"> Power cable without lugs Power Cable with North-American plug for pluggable terminal blocks (6 ft.) for RUGGEDCOM products 	6GK6000-8BB00-0AA0		
<ul style="list-style-type: none"> Panel Mounting Kit for RUGGEDCOM RSG900C Allows for wall and other lateral mounting for the RUGGEDCOM RSG908C and RSG910C 	6GK6000-8MR00-0AA1		
<ul style="list-style-type: none"> RJ45 Dust Covers kit RJ45 dust covers for RUGGEDCOM products, 8 pieces 	6GK6000-8HT01-0CA0		
<ul style="list-style-type: none"> SFP Dust Covers kit SFP dust covers for RUGGEDCOM products, 12 pieces 	6GK6000-8HT02-0CA0		
RUGGEDCOM SFPs			
Copper Ethernet SFP			
<ul style="list-style-type: none"> RUGGEDCOM SFP112-1 Copper SFP, 10/100/1000 Mbit/s, RJ45-Interface, Copper, up to max. 100 m, 0 °C ...+70 °C 	6GK6000-8CG01-0AA0		
Fiber Optic SFPs (Fast Ethernet)			
<ul style="list-style-type: none"> RUGGEDCOM SFP1121-1FX2A 100BASE-FX, LC-Interface, Optical: Multi Mode Fiber Optic up to max. 2 km, 1310 nm, -40 °C ...+85 °C. Only compatible with the RUGGEDCOM devices supporting active SFPs 	6GK6000-8FE50-0AA0		
<ul style="list-style-type: none"> RUGGEDCOM SFP1131-1FX10A 100BASE-LX, LC-Interface, Optical: Single-mode Fiber Optic up to max. 10 km, 1310 nm, -40 °C ...+85 °C. Only compatible with the RUGGEDCOM devices supporting active SFPs 	6GK6000-8FE60-0AA0		
<ul style="list-style-type: none"> RUGGEDCOM SFP1131S-1LX40A 100BASE-LX, LC-Interface, Optical: Single-mode Fiber Optic up to max. 40 km, 1310 nm, -5 °C ...+70 °C. Only compatible with the RUGGEDCOM devices supporting active SFPs 	6GK6000-8FE62-0AA0		
		Fiber Optic SFPs (Gigabit)	
		<ul style="list-style-type: none"> RUGGEDCOM SFP1122-1SX 1000BASE-SX, LC-Interface, Optical: Multi Mode Fiber Optic up to max. 500 m, 850 nm, -40 °C ...+85 °C 	6GK6000-8FG51-0AA0
		<ul style="list-style-type: none"> RUGGEDCOM SFP1122-1SX2 1000BASE-SX, LC-Interface, Optical: Multi Mode Fiber Optic up to max. 2 km, 1310 nm, -40 °C ...+85 °C 	6GK6000-8FE58-0AA0
		<ul style="list-style-type: none"> RUGGEDCOM SFP1132-1LX10 1000BASE-LX, LC-Interface, Optical: Single Mode Fiber Optic up to max. 10 km, 1310 nm, -40 °C ...+85 °C 	6GK6000-8FG52-0AA0
		<ul style="list-style-type: none"> RUGGEDCOM SFP1132-1LX25 1000BASE-LX, LC-Interface, Optical: Single Mode Fiber Optic up to max. 25 km, 1310 nm, -40 °C ...+85 °C 	6GK6000-8FG53-0AA0
		<ul style="list-style-type: none"> RUGGEDCOM SFP1132-1LX40 1000BASE-LX, LC-Interface, Optical: Single Mode Fiber Optic up to max. 40 km, 1550 nm, -40 °C ...+85 °C 	6GK6000-8FG57-0AA0
		<ul style="list-style-type: none"> RUGGEDCOM SFP1132-1LX70 1000BASE-LX, LC-Interface, Optical: Single Mode Fiber Optic up to max. 70 km, 1550 nm, -40 °C ...+85 °C 	6GK6000-8FG54-0AA0
		<ul style="list-style-type: none"> RUGGEDCOM SFP1132-1LX115 1000BASE-LX, LC-Interface, Optical: Single Mode Fiber Optic up to max. 115 km, 1550 nm, -10 °C ...+70 °C 	6GK6000-8FE56-0AA0
		Fiber Optic Bi-Directional SFPs (Gigabit)	
		<ul style="list-style-type: none"> RUGGEDCOM SFP1132-1BX10R 1000BASE-BX-U, LC-Interface, Optical: Single Mode Fiber Optic up to max. 10 km, 1310 nm TX/1490 nm RX, -40 °C ...+85 °C 	6GK6000-8FB51-0AA0
		<ul style="list-style-type: none"> RUGGEDCOM SFP1132-1BX10T 1000BASE-BX-D, LC-Interface, Optical: Single Mode Fiber Optic up to max. 10 km, 1490 nm TX/1310 nm RX, -40 °C ...+85 °C 	6GK6000-8FB52-0AA0
		<ul style="list-style-type: none"> RUGGEDCOM SFP1132-1BX40R 1000BASE-BX-U, LC-Interface, Optical: Single Mode Fiber Optic up to max. 40 km, 1310 nm TX/1490 nm RX, -40 °C ...+85 °C 	6GK6000-8FB53-0AA0
		<ul style="list-style-type: none"> RUGGEDCOM SFP1132-1BX40T 1000BASE-BX-D, 1 X 1000 Mbit/s, LC-Interface, Optical: Single Mode Fiber Optic up to max. 40 km, 1490 nm TX/1310 nm RX, -40 °C ...+85 °C 	6GK6000-8FB54-0AA0

Overview

The RUGGEDCOM RST2228 and RST2228P are high port density field modular 19" Layer 2 rack switches with 10 Gbit/s uplinks and support for IEEE 1588. The RST2228P supports power-over-Ethernet according to IEEE 802.3at/bt (draft).

Design

- Up to 28 Ethernet ports – 4 x 1000BASE-X/10GBASE-X integrated uplinks and up to 24 x 10/100/1000BASE-X ports
- 6 slots for 4-port Media Modules for tremendous flexibility
- RNA module with 2 x 100/1000Mbit/s RJ45 to support HSR/PRP function
- Media modules with 4 x 10/100/1000 Mbit/s RJ45, Siemens FastConnect cabling system support, 100/1000 Mbit/s SFP interfaces and 100FX LC interfaces supporting multi-mode fiber optics up to 2 kilometers
- Support for up to 24 Power-over-Ethernet (PoE) interfaces according to IEEE 802.3at/bt (draft) with up to 60W/port and a total power budget of 500W distributed over all PoE ports
- Supports precision timing according to IEEE 1588 (transparent clock)
- Non-blocking, store and forward switching
- Dual-redundant (optional), load sharing power supplies
- For use at ambient temperatures from –40 °C to +85 °C without the use of fans

Product versions
RUGGEDCOM RST2228

- 28-port field modular managed layer 2 Gbit/s switch with 10 Gbit/s uplinks supporting IEEE 1588

RUGGEDCOM RST2228P

- 28-port field modular managed layer 2 Gbit/s switch with 10 Gbit/s uplinks supporting IEEE 1588 and Power-over-Ethernet according to IEEE 802.3at/bt (draft)

Benefits

- Future-proof Ethernet switch with high port density to minimize capital expense by reducing the number of layer 2 switching devices needed.
- Field-modular media modules with RJ45, FastConnect, Power-over-Ethernet, LC & SFP interfaces and build-to-order design ensures seamless servicing and tremendous flexibility in tailoring the device configuration resulting in lower operating expenses.
- Suitable for usage in electric power, transportation and oil & gas applications due to a utility grade design with immunity against EMI and heavy electrical surges.
- Future-proof due to support of modern IEEE 1588 time synchronization features and modular construction that allows network traffic growth to be accommodated by changing only the modules.
- Suitable for usage in harsh environments with the minimal risk of mechanical failures due to an operating temperature from –40 to +85 °C without fans.

Ordering data
Article No.
RUGGEDCOM Rack Switches
RUGGEDCOM RST2228

RUGGEDCOM RST2228 is a field modular, fully managed Layer 2 Ethernet switch with 4 x 1/10 Gbit/s and 24 x 100/1000 Mbit/s non-blocking ethernet ports. Support for up to six 4-port media modules with RJ45, SFP or LC interfaces; –40 °C ... +85 °C operating temperature (fanless)

6GK6222-6AB..-....
RUGGEDCOM RST2228P

RUGGEDCOM RST2228P is a field modular, fully managed Layer 2 Ethernet switch with 4 x 1/10 Gbit/s and 24 x 100/1000 Mbit/s non-blocking ethernet ports supporting Power-over-Ethernet. Support for up to six 4-port media modules with RJ45, SFP or LC interfaces; –40 °C ... +85 °C operating temperature (fanless)

6GK6222-6PB..-....
RUGGEDCOM accessories
Media Modules (Standard)

- **RUGGEDCOM RMM2972-2RNA**
Media Module for RUGGEDCOM RST2228, RST2228P to support HSR/PRP functions; port A and B, 2 x 100/1000 Base-X
6GK6297-8SB00-2AA0
- **RUGGEDCOM RMM2973-4RJ45**
Media Module for RUGGEDCOM RST2228, 4 x RJ45, 10/100/1000 BASE-TX
6GK6297-3RD00-4AB0
- **RUGGEDCOM RMM2973-4FC**
Media Module for RUGGEDCOM RST2228, 4 x FastConnect (RJ45), 10/100/1000 BASE-TX
6GK6297-3FD00-4AB0
- **RUGGEDCOM RMM2973-4POE**
Media Module for RUGGEDCOM RST2228, 4 x 10/100/1000 Mbit/s Power-over-Ethernet (RJ45) according to IEEE 802.3at/bt (draft) supporting 60 Watt/interface with shared power budget from 120 Watt/module
6GK6297-3PD00-4AB0
- **RUGGEDCOM RMM2973-4PFC**
Media Module for RUGGEDCOM RST2228, 4 x 10/100/1000 Mbit/s Power-over-Ethernet (FastConnect) according to IEEE 802.3at/bt (draft) supporting 60 Watt/interface with shared power budget from 120 Watt/module
6GK6297-3WD00-4AB0
- **RUGGEDCOM RMM2972-4SFP**
Media Module for RUGGEDCOM RST2228, 4 x SFP-slot, Supporting 100BASE-FX, 1000BASE-X SFPs, SFPs are not included
6GK6297-2SA00-4AA0
- **RUGGEDCOM RMM2942-4LC2**
Media Module for RUGGEDCOM RST2228, 4 x 100 Mbit/s LC supporting multi-mode fiber optics up to 2 km
6GK6294-2LD00-4AC0

SIMATIC PCS 7 system hardware

Industrial communication

Industrial Ethernet

RUGGEDCOM rack switch > RUGGEDCOM RST2228 managed

Ordering data	Article No.	Article No.	
Media Modules with Conformal Coating <ul style="list-style-type: none"> • RUGGEDCOM RMM2972-2RNA Media Module for RUGGEDCOM RST2228, RST2228P to support HSR/PRP functions; port A and B, 2 x 100/1000 Base-X • RUGGEDCOM RMM2973-4RJ45 Media Module for RUGGEDCOM RST2228, 4 x RJ45, 10/100/1000 BASE-TX. With Conformal Coating • RUGGEDCOM RMM2973-4FC Media Module for RUGGEDCOM RST2228, 4 x FastConnect (RJ45), 10/100/1000 BASE-TX. With Conformal Coating • RUGGEDCOM RMM2973-4POE Media Module for RUGGEDCOM RST2228, 4 x 10/100/1000 Mbit/s Power-over-Ethernet (RJ45) according to IEEE 802.3at/bt (draft) supporting 60 Watt/interface with shared power budget from 120 Watt/module. With Conformal Coating • RUGGEDCOM RMM2973-4PFC Media Module for RUGGEDCOM RST2228, 4 x 10/100/1000 Mbit/s Power-over-Ethernet (FastConnect) according to IEEE 802.3at/bt (draft) supporting 60 Watt/interface with shared power budget from 120 Watt/module • RUGGEDCOM RMM2972-4SFP Media Module for RUGGEDCOM RST2228, 4 x SFP-slot, Supporting 100BASE-FX, 1000BASE-X SFPs, SFPs are not included with Conformal Coating • RUGGEDCOM RMM2942-4LC2 Media Module for RUGGEDCOM RST2228, 4 x 100 Mbit/s LC supporting multi-mode fiber optics up to 2km. With Conformal Coating 	6GK6297-8SB00-2AA1 6GK6297-3RD00-4AB1 6GK6297-3FD00-4AB1 6GK6297-3PD00-4AB1 6GK6297-3WD00-4AB1 6GK6297-2SA00-4AA1 6GK6294-2LD00-4AC1	RUGGEDCOM accessories <ul style="list-style-type: none"> • USB Console cable USB 2.0 A type to B type Cable Assembly 10 feet / 3 meters • Power cable with lugs Power Cable with north-american plug for screw terminal blocks (6 ft.) for RUGGEDCOM products • Power cable without lugs Power Cable with north-american plug for pluggable terminal blocks (6 ft.) for RUGGEDCOM products • Pluggable terminal block RST2228 Connector Kit RST2228 Pluggable terminal blocks (5 sets) • Screw terminal block RST2228 Connector Kit RST2228 Screw terminal blocks (5 sets) • Rack / Panel Mounting Kit for RUGGEDCOM RST2228 Allows for mounting in a 19" rack or in a panel • RJ45 Dust Covers kit RJ45 dust covers for RUGGEDCOM products, 8 pieces • SFP Dust Covers kit SFP dust covers for RUGGEDCOM products, 12 pieces 	6GK6000-8DT01-0AA0 6GK6000-8BA00-0AA0 6GK6000-8BB00-0AA0 6GK6000-8HC05-0AA0 6GK6000-8HC06-0AA0 6GK6000-8BB00-0AA0 6GK6000-8HT01-0CA0 6GK6000-8HT02-0CA0
Blank modules <ul style="list-style-type: none"> • RUGGEDCOM RMM2931-4 Blank Media Module for RUGGEDCOM RST2228 	6GK6293-1BA00-4AA0	RUGGEDCOM Storage Media <ul style="list-style-type: none"> • RUGGEDCOM CLP 2GB Storage media for simple device exchange in case of failure, for storage of configuration or user data with 2 GB capacity. • RUGGEDCOM CLP 2GB CC Storage media for simple device exchange in case of failure, for storage of configuration or user data with 2 GB capacity and Conformal Coating. 	6GK6000-8RA00-1HA0 6GK6000-8RA00-1HA1

Ordering data	Article No.	Article No.	
RUGGEDCOM SFPs Copper Ethernet SFP <ul style="list-style-type: none"> • RUGGEDCOM SFP1112-1 Copper SFP, 10/100/1000 MBit/s RJ45-Interface, Copper, up to max. 100 m, 0...+70 Degrees Celcius Fiber Optic SFPs (Fast Ethernet) <ul style="list-style-type: none"> • RUGGEDCOM SFP1121-1FX2 100BASE-FX, LC-Interface, Optical: Multi Mode Fiber Optic up to max. 2 km, 1310 nm, -40...+85 Degrees Celcius • RUGGEDCOM SFP1121-1FX2A 100BASE-FX, LC-Interface, Optical: Multi Mode Fiber Optic up to max. 2 km, 1310 nm, -40...+85 Degrees Celcius • RUGGEDCOM SFP1131-1FX10A 100BASE-LX, LC-Interface, Optical: Single-mode Fiber Optic up to max. 10 km, 1310 nm, -40...+85 Degrees Celcius. Only compatible with the RUGGEDCOM devices supporting active SFPs. • RUGGEDCOM SFP1131-1FX20 100BASE-FX, LC-Interface, Optical: Single Mode Fiber Optic up to max. 20 km, 1310 nm, -40...+85 Degrees Celcius • RUGGEDCOM SFP1131S-1LX40A 100BASE-LX, LC-Interface, Optical: Single-mode Fiber Optic up to max. 40 km, 1310 nm, -5...+70 Degrees Celcius. Only compatible with the RUGGEDCOM devices supporting active SFPs • RUGGEDCOM SFP1131-1XF50 100BASE-FX, LC-Interface, Optical: Single Mode Fiber Optic up to max. 50 km, 1310 nm, -40...+85 Degrees Celcius • RUGGEDCOM SFP1131-1XF90 100BASE-FX, LC-Interface, Optical: Single Mode Fiber Optic up to max. 90 km, 1550 nm, -40...+85 Degrees Celcius Fiber Optic SFPs (Gigabit) <ul style="list-style-type: none"> • RUGGEDCOM SFP1122-1SX 1000BASE-SX, LC-Interface, Optical: Multi Mode Fiber Optic up to max. 500 m, 850 nm, -40...+85 Degrees Celcius • RUGGEDCOM SFP1122-1SX2 1000BASE-SX, LC-Interface, Optical: Multi Mode Fiber Optic up to max. 2 km, 1310 nm, -40...+85 Degrees Celcius • RUGGEDCOM SFP1132-1LX10 1000BASE-LX, LC-Interface, Optical: Single Mode Fiber Optic up to max. 10 km, 1310 nm, -40...+85 Degrees Celcius • RUGGEDCOM SFP1132-1LX25 1000BASE-LX, LC-Interface, Optical: Single Mode Fiber Optic up to max. 25 km, 1310 nm, -40...+85 Degrees Celcius • RUGGEDCOM SFP1132-1LX40 1000BASE-LX, LC-Interface, Optical: Single Mode Fiber Optic up to max. 40 km, 1550 nm, -40...+85 Degrees Celcius • RUGGEDCOM SFP1132-1LX70 1000BASE-LX, LC-Interface, Optical: Single Mode Fiber Optic up to max. 70 km, 1550 nm, -40...+85 Degrees Celcius • RUGGEDCOM SFP1132-1LX115 1000BASE-LX, LC-Interface, Optical: Single Mode Fiber Optic up to max. 115 km, 1550 nm, -10...+70 Degrees Celcius 	6GK6000-8CG01-0AA0 6GK6000-8FE51-0AA0 6GK6000-8FE50-0AA0 6GK6000-8FE60-0AA0 6GK6000-8FE52-0AA0 6GK6000-8FE62-0AA0 6GK6000-8FE53-0AA0 6GK6000-8FE54-0AA0 6GK6000-8FG51-0AA0 6GK6000-8FE58-0AA0 6GK6000-8FG52-0AA0 6GK6000-8FG53-0AA0 6GK6000-8FG57-0AA0 6GK6000-8FG54-0AA0 6GK6000-8FE56-0AA0	Fiber Optic Bi-Directional SFPs (Gigabit) <ul style="list-style-type: none"> • RUGGEDCOM SFP1132-1BX10R 1000BASE-BX-U, LC-Interface, Optical: Single Mode Fiber Optic up to max. 10 km, 1310 nm TX/1490 nm RX, -40...+85 Degrees Celcius • RUGGEDCOM SFP1132-1BX10T 1000BASE-BX-D, LC-Interface, Optical: Single Mode Fiber Optic up to max. 10 km, 1490 nm TX/1310 nm RX, -40...+85 Degrees Celcius • RUGGEDCOM SFP1132-1BX40R 1000BASE-BX-U, LC-Interface, Optical: Single Mode Fiber Optic up to max. 40 km, 1310 nm TX/1490 nm RX, -40...+85 Degrees Celcius • RUGGEDCOM SFP1132-1BX40T 1000BASE-BX-D, 1 X 1000 MBit/s, LC-Interface, Optical: Single Mode Fiber Optic up to max. 40 km, 1490 nm TX/1310 nm RX, -40...+85 Degrees Celcius Fiber Optic SFP+ (10 Gigabit) <ul style="list-style-type: none"> • RUGGEDCOM SFP2123-1SR 10GBASE-SR, LC- Interface, Optical: Multi Mode Fiber Optic up to max. 300 m, 850 nm, -40...+85 Degrees • RUGGEDCOM SFP2133-1LR10 10GBASE-LR, LC- Interface, Optical: Single Mode Fiber Optic up to max. 10 km, 1310 nm, -40...+85 Degrees Celcius • RUGGEDCOM SFP2133-1ER40 10GBASE-ER, LC- Interface, Optical: Single Mod e Fiber Optic up to max. 40 km, 1550 nm, -40...+85 Degrees Celcius • RUGGEDCOM SFP2133-1ZR80 10GBASE-ZR, LC- Interface, Optical: Single Mode Fiber Optic up to max. 80 km, 1550 nm, -40...+85 Degrees Celcius 	6GK6000-8FB51-0AA0 6GK6000-8FB52-0AA0 6GK6000-8FB53-0AA0 6GK6000-8FB54-0AA0 6GK6000-8FT50-0AA0 6GK6000-8FT51-0AA0 6GK6000-8FT53-0AA0 6GK6000-8FT52-0AA0

SIMATIC PCS 7 system hardware

Industrial communication

Industrial Ethernet

SCALANCE XR-300 switches

Overview

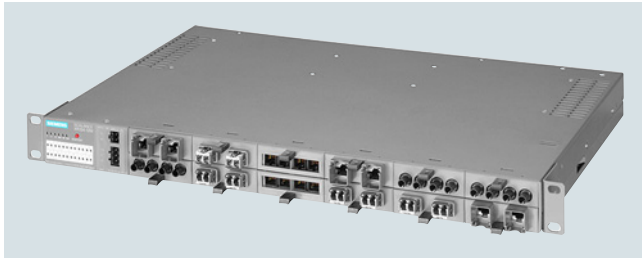

The SCALANCE XR-300 Industrial Ethernet switches are partially and fully modular, high-performance, industry-standard switches for the setup of electrical and optical line, ring and star topologies with transmission rates of 10/100/1000 Mbps, designed for installation in 19" control cabinets.

- Up to 24 electrical and/or optical interfaces (10/100/1000 Mbps); up to 12 electrical and/or optical 2-port media modules can be inserted at any position in the basic unit
- High-speed media redundancy through integrated redundancy manager both for Gigabit Ethernet (with SCALANCE X-200, X-300, XM-400, XR-500) and Fast Ethernet (e.g. in combination with SCALANCE XB-200 switches)
- Seamless integration of automation networks in existing corporate networks since numerous IT standard functions are supported (VLANs, IGMP Snooping/Querier, STP/RSTP, Link Aggregation, Quality of Service)
- Redundant integration into higher-level networks thanks to support for standardized redundancy procedures (Spanning Tree Protocol/Rapid Reconfiguration Spanning Tree Protocol/MRP)
- Remote diagnostics with integrated system diagnostics over PROFINET, web browser, CLI or SNMP
- Integration into the SINEMA Server or SINEC NMS network management system for integrated network diagnostics with central firmware management
- SCALANCE XR324-4M PoE, XR324-4M PoE TS: As many as 24 electrical and/or optical interfaces (10/100/1 000 Mbps), of which 16 are integrated RJ45 ports, eight of which are PoE-compatible; up to 4 electrical and/or optical 2-port media modules can additionally be inserted in the media module slots of the basic unit
- SCALANCE XR-300EEC: Suitable for use in extremely harsh industrial environments and in low-voltage and high-voltage switchgear thanks to:
 - Extended temperature range (-40 to +70 °C, briefly to +85 °C)
 - Support for special protocols and standards (IEEE 1613 and IEC 61850-3)
 - Wide-range power supplies (60 to 250 V AC/DC)

Benefits

g e t Designed for Industry

- Unlimited flexibility for network expansions (e.g. more terminal devices) or conversion (e.g. switching from copper to FOC) and reduction of storage costs due to the modular construction using port modules
- High availability of the network thanks to:
 - Redundant power supply
 - Redundant network structures based on fiber-optic or twisted-pair cables (redundancy manager, standby function and STP/RSTP are integrated)
 - Easy device replacement by means of C-PLUG removable data storage medium
 - Extremely fast network reconfiguration in the event of a fault
- Lower susceptibility to failure and higher availability of the plant networking due to latching of the RJ45 FastConnect connectors in the sleeve of the RJ45 port modules
- Protection of investment through integration into existing network management systems (e.g. SINEMA Server or SINEC NMS) by means of standardized SNMP access
- Time saving during engineering, commissioning and in the operating phase of a plant by using the integrated configuration and diagnostics in STEP 7, without additional software
- Space savings in control cabinet due to flexible cable outlet on the front or rear of the device
- SCALANCE XR324-4M PoE, XR324-4M PoE TS: Savings in terms of additional power supply units and cabling for terminal devices thanks to PoE power supply
- SCALANCE XR-300EEC: Increased availability of the network thanks to hardware and software functions specially geared to the particular requirements of energy technology plants and extreme environmental conditions

Design

The SCALANCE XR-300 Industrial Ethernet switches with rugged metal enclosure with IP30 degree of protection are optimized for installation in the 19" control cabinet. Versions are available with either 24 V DC or 100-240 V AC connections. The connection of the power supply and the data cable outlet are located optionally either at the front or rear of the device.

The switches have:

- 4-pin joint block for redundant voltage feed for protection against voltage failure in 24 V DC version
- 3-pin joint block for voltage feed in 100-240 V AC version
- 2-pin joint block for connecting the isolated signaling contact for simple display of faults
- Row of LEDs for indicating status information (power, link status, data transfer, power supply, signaling contact)
- SELECT/SET pushbutton for easy setting of the fault signaling contact on the device
- Slot for optional C-PLUG removable data storage medium on the side of the device for easy replacement in the event of a fault
- Console port (serial interface) for on-site parameterization/diagnostics (RJ11 cable to RS232 (9-pin) included in scope of delivery)

The SCALANCE XR-300 switches are available with the following port types:

- 12 slots for electrical or optical 2-port media modules for multi-mode or single-mode connections; the optical media modules are available in various connection technologies
- The RJ45 sockets are designed to be industry-compatible with additional securing collars for connection of the Industrial Ethernet FC RJ45 Plug 180
- All electrical Ethernet interfaces support 10/100/1000 Mbps, all optical Ethernet interfaces support 100 or 1000 Mbps
- The SCALANCE XR-300 switches support Gigabit Ethernet (1000 Mbps) at all ports. The 24 ports are divided into three groups of eight ports each (Gigabit Ethernet Blocking). Gigabit Ethernet is supported with full wire speed within each group, but not between the groups
- For the SCALANCE XR-300PoE switches, eight of 16 integrated RJ45 ports support PoE

Product versions

SCALANCE XR324-12M (12 media module slots)

Versions are available with

- LEDs, power supply connection and data cable outlet on the front
- LEDs on the front, power supply connection and data cable outlet at the rear

All versions have twelve media module slots and

- 1 x 24 V DC power supply unit
- 1 x 100-240 V AC power supply unit

SCALANCE XR324-12M TS (12 media module slots)

A version is available with

- LEDs, power supply connection and data cable outlet on the front

The SCALANCE XR324-12M TS has twelve media module slots and

- 1 x 24 V DC power supply unit

SCALANCE XR324-4M PoE (4 media module slots)

Versions are available with

- LEDs, power supply connection and data cable outlet on the front
- LEDs on the front, power supply connection and data cable outlet at the rear

All versions have twelve media module slots and

- 1 x 24 V DC power supply unit
- 1 x 100-240 V AC power supply unit

SCALANCE XR324-4M PoE TS (4 media module slots)

A version is available with

- LEDs, power supply connection and data cable outlet at the front;

The version has four media module slots and

- 1 x 24 V DC power supply unit

SCALANCE XR324-4M EEC (4 media module slots)

Versions are available with

- LEDs, data cable outlet on the front and power supply connection at the rear
- LEDs, power supply connection on the front, data cable outlet at the rear

All versions have four media module slots and

- 1 x 24 V DC power supply unit
- 2 x 24 V DC power supply units
- 1 x 230 V AC power supply unit
- 2 x 230 V AC power supply units

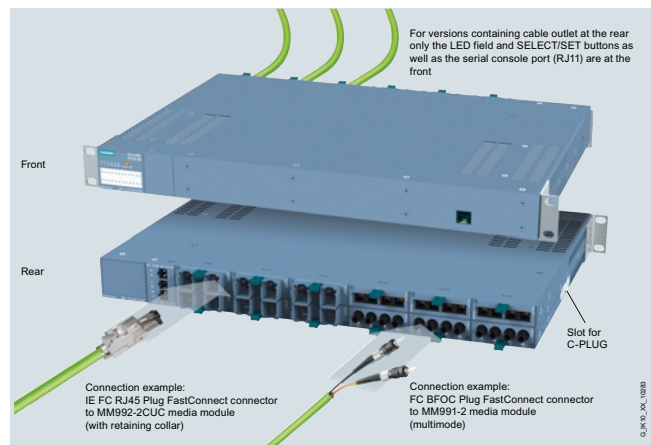

SCALANCE XR-300 with cable outlet at rear

SIMATIC PCS 7 system hardware

Industrial communication

Industrial Ethernet

SCALANCE XR-300 switches

Ordering data	Article No.	Article No.
<p>SCALANCE XR324 Industrial Ethernet Switches</p> <p>Fully modular 19" Industrial Ethernet switches for setting up electrical and/or optical Industrial Ethernet networks; all ports can optionally be equipped with optical or electrical 2-port media modules; All ports support Gigabit Ethernet (blocking), integrated redundancy manager, RSTP, RMON, IGMP-Snooping/Querier, network management via SNMP, PROFINET, and web server 12 x 10/100/1 000 Mbps slots for 2-port media modules, electrical or optical</p>		<p>Media Modules</p> <p>See "Media modules for modular SCALANCE X-300 managed"</p>
<p>SCALANCE XR324-12M</p> <p>24 V DC power supply</p> <ul style="list-style-type: none"> Data cable outlet at front Data cable outlet at rear <p>110 ... 230 V AC power supply</p> <ul style="list-style-type: none"> Data cable outlet at front Data cable outlet at rear 	<p>6GK5324-0GG10-1AR2 6GK5324-0GG10-1HR2</p> <p>6GK5324-0GG10-3AR2 6GK5324-0GG10-3HR2</p>	<p>Accessories</p> <p>SCALANCE PS598-1 Power Supply</p> <p>6GK5598-1AA00-3AA0</p> <p>SCALANCE PS598-1 power supply 300 W Input: 85-264 V AC IEC plug; Output: 24 V DC terminals or for direct connection to SCALANCE XR-300</p> <p>IE FC RJ45 Plug 180 2 x 2</p> <p>RJ45 plug-in connector for Industrial Ethernet with a rugged metal enclosure and integrated insulation displacement contacts for connecting Industrial Ethernet FC installation cables; with 180° cable outlet; for network components and CPs/CPU with Industrial Ethernet interface</p> <ul style="list-style-type: none"> 1 pack = 1 unit <p>6GK1901-1BB10-2AA0</p>
<p>SCALANCE XR324-12M TS</p> <p>For railway applications (approval in accordance with EN 50155); 24 V DC power supply</p> <ul style="list-style-type: none"> Data cable outlet at front 	<p>6GK5324-0GG10-1CR2</p>	<p>IE FC TP Standard Cable GP 2 x 2 (Type A)</p> <p>6XV1840-2AH10</p> <p>4-wire, shielded TP installation cable for connection to IE FC outlet RJ45/IE FC RJ45 plug; PROFINET-compliant; with UL approval; sold by the meter; max. delivery unit 1 000 m, minimum order quantity 20 m, also available as pre-assembled cable with RJ45 connectors in various lengths</p>
<p>SCALANCE XR324-4M PoE</p> <p>24 V DC power supply</p> <ul style="list-style-type: none"> Data cable outlet at front Data cable outlet at rear <p>100 ... 240 V AC power supply</p> <ul style="list-style-type: none"> Data cable outlet at front Data cable outlet at rear 	<p>6GK5324-4QG10-1AR2 6GK5324-4QG10-1HR2</p> <p>6GK5324-4QG10-3AR2 6GK5324-4QG10-3HR2</p>	<p>IE FC RJ45 Plug 4 x 2</p> <p>RJ45 plug-in connector for Industrial Ethernet (10/100/1 000 Mbps) with a rugged metal enclosure and integrated insulation displacement contacts for connecting Industrial Ethernet FC installation cables; 180° cable outlet; for network components and CPs/CPU with Industrial Ethernet interface</p> <ul style="list-style-type: none"> 1 pack = 1 unit <p>6GK1901-1BB12-2AA0</p>
<p>SCALANCE XR324-4M PoE TS</p> <p>For railway applications (approval in accordance with EN 50155); 24 V DC power supply</p> <ul style="list-style-type: none"> Data cable outlet at front 	<p>6GK5324-4QG10-1CR2</p>	<p>IE FC M12 Plug PRO 4x2</p> <p>M12 plug-in connector suitable for on-site assembly (X-coded, IP65/IP67), metal enclosure, insulation displacement fast connection method, for SCALANCE W</p> <ul style="list-style-type: none"> 1 unit <p>6GK1901-0DB30-6AA0</p>
<p>SCALANCE XR324-4M EEC</p> <p>1 x 24 V DC power supply</p> <ul style="list-style-type: none"> Data cable outlet at front Power supply at rear Data cable outlet at rear Power supply at front <p>1 x 100-240 AC/60-250 V DC power supply</p> <ul style="list-style-type: none"> Data cable outlet at front Power supply at rear Data cable outlet at rear Power supply at front <p>2 x 24 V DC power supply</p> <ul style="list-style-type: none"> Data cable outlet at front Power supply at rear Data cable outlet at rear Power supply at front <p>2 x 100-240 AC/60-250 V DC power supply</p> <ul style="list-style-type: none"> Data cable outlet at front Power supply at rear Data cable outlet at rear Power supply at front 	<p>6GK5324-4GG10-1ER2 6GK5324-4GG10-1JR2</p> <p>6GK5324-4GG10-3ER2 6GK5324-4GG10-3JR2</p> <p>6GK5324-4GG10-2ER2 6GK5324-4GG10-2JR2</p> <p>6GK5324-4GG10-4ER2 6GK5324-4GG10-4JR2</p>	<p>IE FC TP Standard Cable GP 4 x 2</p> <p>6XV1878-2A</p> <p>8-wire, shielded TP installation cable for connection to IE FC RJ45 modular outlet for universal application; with UL approval; sold by the meter; max. delivery unit 1 000 m, minimum order quantity 20 m, also available as pre-assembled cable with RJ45 connectors and M12 plugs (X-coded) in various lengths</p>
		<p>IE SC RJ POF Plug</p> <p>6GK1900-0MB00-0AC0</p> <p>Screw connector for local assembly on POF FOC (1 pack = 20 units)</p>

Ordering data	Article No.	Ordering data	Article No.
POF Standard Cable GP 980/1000 POF standard cable for fixed routing indoors with PVC sheath; sold by the meter; max. delivery unit 1 000 m, minimum order quantity 20 m	6XV1874-2A	FO Standard Cable GP 50/125/1400 Multimode cable, sold by the meter; max. delivery unit 1 000 m, minimum order quantity 20 m, also available pre-assembled with ST/BFOC, SC and LC connectors in various lengths	6XV1873-2A
Termination Kit SC RJ POF Plug Assembly case for on-site installation of SC RJ POF connectors, consisting of stripping tool, Kevlar cutters, SC RJ grinding plate, grinding paper, grinding base, and microscope	6GK1900-0ML00-0AA0	C-PLUG Removable data storage medium for simple replacement of devices in the event of a fault; for storing configuration or engineering and application data; can be used in SIMATIC NET products with C-PLUG slot	6GK1900-0AB00
IE SC RJ PCF Plug Screw connector for local assembly on PCF FOC (1 pack = 10 units)	6GK1900-0NB00-0AC0	SCALANCE TAP104 Test access port for the reaction-free extraction of Ethernet data frames (10/100 Mbps) from both transmission directions; extracts complete data traffic, including faulty frames, for further diagnostics.	6GK5104-0BA00-1SA2
PCF Standard Cable GP 200/230 Standard cable, segmentable, sold by the meter; max. delivery unit 2 000 m, minimum order quantity 20 m, also available as pre-assembled cable with ST/BFOC connectors in various lengths	6XV1861-2A	Notes: <ul style="list-style-type: none"> You can find more information on the FastConnect range in the https://support.industry.siemens.com/cs/document/109766358/ordering-overview-cabling-technology-for-communication-networks-in-industry?dti=0&lc=en-DE ordering overview You can order supplementary components for the SIMATIC NET cabling range from your local contact. Technical advice on this subject is available from: J. Hertlein DI PA CI PRM 4 Tel.: +49 (172) 3172810 E-mail: juergen.hertlein@siemens.com 	
Termination Kit SC RJ PCF Plug Assembly case for on-site installation of SC RJ PCF connectors, consisting of stripping tool, buffer stripping tool, Kevlar cutters, fiber breaking tool, microscope	6GK1900-0NL00-0AA0		

SIMATIC PCS 7 system hardware

Industrial communication

Industrial Ethernet

SCALANCE XR-300 switches > Media modules for SCALANCE XR-300

Overview

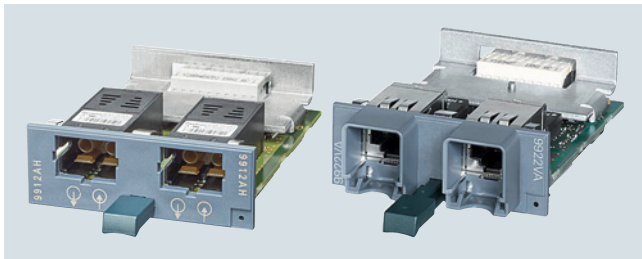

- Electrical versions with RJ45 ports are available, as are optical versions with ST/BFOC, SC and SC RJ ports for the use of POF/PCF, multimode and single-mode fiber-optic cables

Product variants — media modules

Electrical media modules with 2 x 10/100/1000 Mbps RJ45 ports

- MM992-2CU: variants with and without retaining collar, variant with retaining collar and conformal coated PCBs

Electrical media modules with 2 x 1/10/100/1000 Mbps RJ45 ports

- MM992-2VD: with retaining collar and additional two-wire transmission function (variable distance) for establishing Ethernet connections via non-Ethernet-conformant cables as well. Bridgeable distance, depending on the cable quality (e.g. 500 mm PROFINET communication with Gigabit Ethernet cable)

Electrical media modules with 2 x 10/100/1000 Mbps M12 ports

- MM992-2: variant with M12 interface (x-coded), variant with M12 interface and coated PCBs

Optical media modules with 2 x 100 Mbps BFOC ports

- MM991-2 multimode, glass, up to 5 km: variant with ST/BFOC ports, variant with SC ports
- MM991-2FM multimode, glass, up to 5 km with fiber-optic cable diagnostics (fiber monitoring)
- MM991-2LD single-mode, glass, up to 26 km, variant with ST/BFOC ports, variant with SC ports
- MM991-2LH+ single-mode, glass, up to 70 km, SC ports
- MM991-2P POF fiber-optic cable up to 50 m, PCF fiber-optic cable up to 100 m, SC RJ ports

Optical media modules with 2 x 1000 Mbps SC ports

- MM992-2: variant with multimode, glass, up to 750 m plus variant with multimode, glass, up to 750 m and conformal coated PCBs
- MM992-2LD single-mode, glass, up to 10 km
- MM992-2LH single-mode, glass, up to 40 km
- MM992-2LH+ single-mode, glass, up to 70 km
- MM992-2ELH single-mode, glass, up to 120 km

Optical media modules with 2 x 100/1000 Mbps for SFP plug-in transceiver

- MM992-2SFP for SFP plug-in transceivers: variant with 1 x 100 Mbps or 1 x 1000 Mbps multimode or single-mode, glass as well as variant with 1 x 100 Mbps or 1 x 1000 Mbps multimode or single-mode, glass and conformal coated PCBs

Benefits

g e t Designed for Industry

- Unlimited flexibility in the case of network expansions (e.g. more terminals) or conversion (e.g. from copper to fiber-optic cables) due to modular design with media modules
- Reduction of storage costs and maintenance overhead by focusing on a few basic device versions

Design

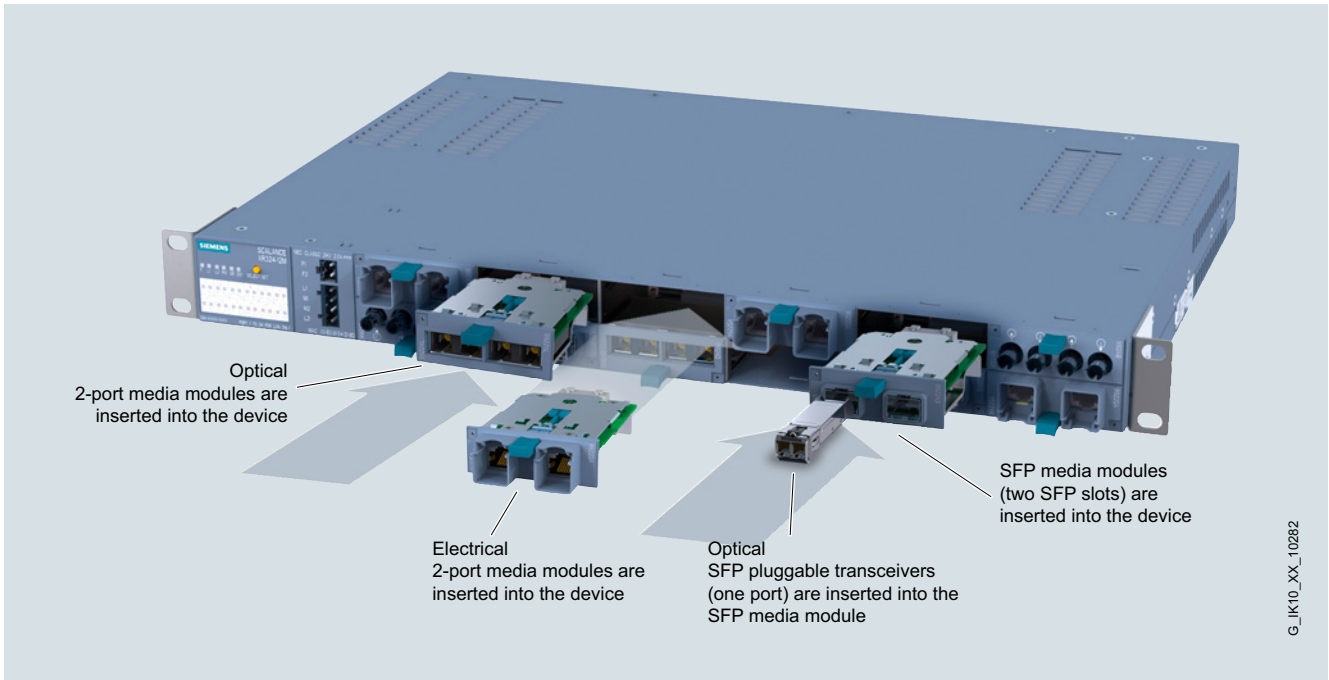

G_JK10_XX_10282

Insertion of 2-port media modules in media module slot

		10 Gigabit Ethernet		Gigabit Ethernet			Fast Ethernet		
		10 Gbit/s		10/100/1000 Mbit/s	1000 Mbit/s		100 Mbit/s		
		Optical		Electrical	Optical		Optical		Max. distance
	Module type	Multimode	Singlemode	Twisted Pair	Multimode	Singlemode	Multimode	Singlemode	
	MM992-2CUC			2x RJ45					100 m
	MM992-2CUC ²⁾			2x RJ45					100 m
	MM992-2CU ¹⁾			2x RJ45					100 m
	MM992-2VD ⁴⁾			2x RJ45					5)
	MM992-2M12 ²⁾			2x M12 (X-coded)					100 m
	MM991-2						2x ST/BFOC		5 km
	MM991-2LD							2x ST/BFOC	26 km
	MM991-2FM						2x ST/BFOC		5 km
	MM991-2						2x SC		5 km
	MM991-2LD							2x SC	26 km
	MM991-2LH+							2x SC	70 km
	MM991-2P						2 x SC RJ		50/100 m
	MM992-2					2x SC			750 m
	MM992-2 ²⁾					2x SC			750 m
	MM992-2LD					2x SC			10 km
	MM992-2LH					2x SC			40 km
	MM992-2LH+					2x SC			70 km
	MM992-2ELH					2x SC			120 km
	MM992-2SFP ³⁾					2x LC	2x LC	2x LC	2x LC
MM992-2SFP ²⁾					2x LC	2x LC	2x LC	2x LC	5)

1) Without retaining collar
2) Coated PCBs (conformal coating)
3) For max. 2x SFP modules

4) Communication via 2-, 4-, or 8-wire-cables (Variable Distance)
5) Dependent on the kind of cable and cable quality, transmission speed varies with distance

G_JK10_XX_10277

Overview of media modules for SCALANCE X-300

SIMATIC PCS 7 system hardware

Industrial communication

Industrial Ethernet

SCALANCE XR-300 switches > Media modules for SCALANCE XR-300

Design (continued)

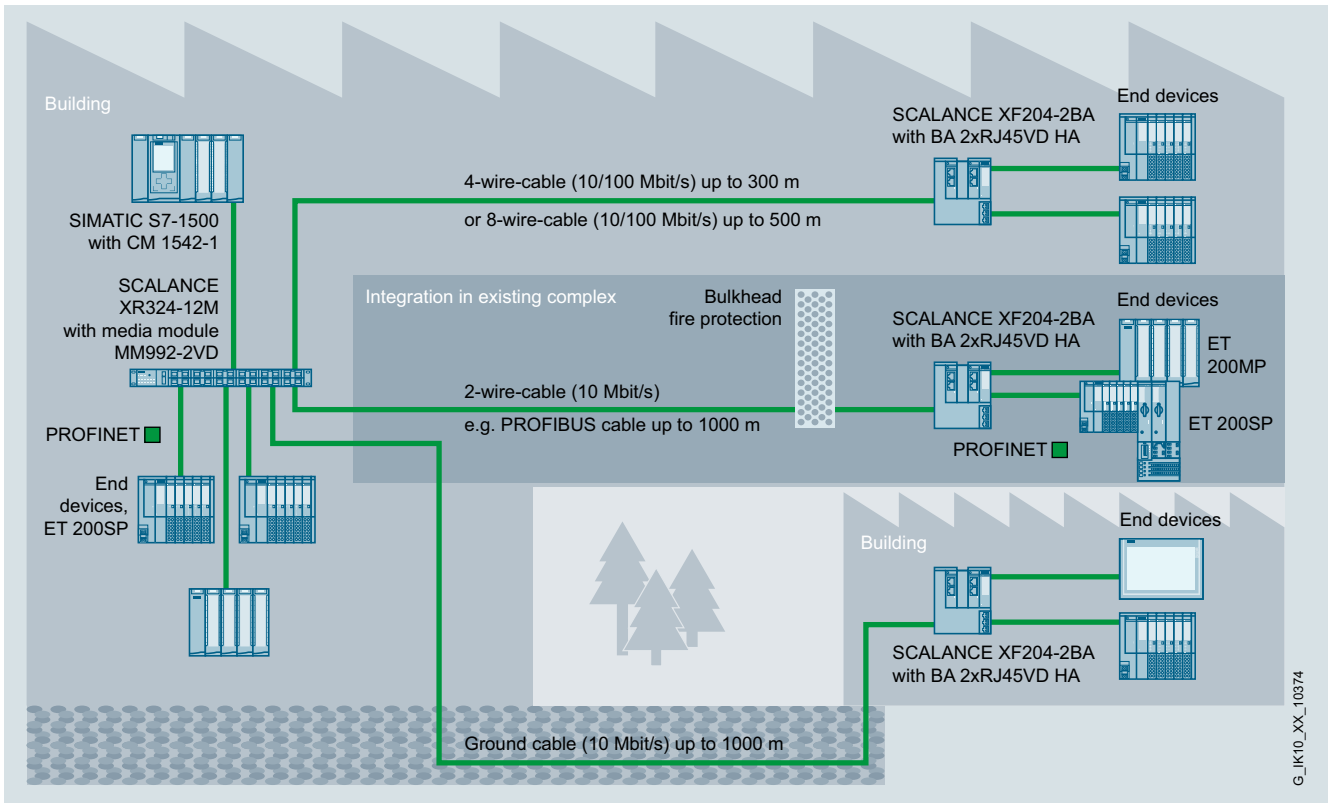

Ethernet communication with MM992-2VD media module

Ordering data	Article No.	Article No.
Electrical media modules		Accessories
with 2 x 10/100/1000 Mbps RJ45 ports, electrical <ul style="list-style-type: none"> MM992-2CUC with retaining sleeve MM992-2CUC with retaining sleeve and coated PCBs (conformal coating) MM992-2CU without retaining sleeve 	6GK5992-2GA00-8AA0	IE FC Stripping Tool 6GK1901-1GA00
	6GK5992-2GA00-8FA0	Pre-adjusted stripping tool for fast stripping of Industrial Ethernet FC cables
	6GK5992-2SA00-8AA0	IE FC RJ45 Plug 180 2 x 2
with 2 x 10/100/1000 Mbps M12 ports, electrical <ul style="list-style-type: none"> MM992-2M12 interface (x-coded) and coated PCBs (conformal coating) 	6GK5992-2HA00-0AA0	RJ45 plug-in connector for Industrial Ethernet with a rugged metal enclosure and integrated insulation displacement contacts for connecting Industrial Ethernet FC installation cables; with 180° cable outlet; for network components and CPs/CPUs with Industrial Ethernet interface
	6GK5992-2VA00-8AA0	• 1 pack = 1 unit 6GK1901-1BB10-2AA0
with 2 x 1/10/100/1000 Mbps RJ45 ports, electrical <ul style="list-style-type: none"> MM992-2VD 	6GK5992-2VA00-8AA0	IE FC TP Standard Cable GP 2 x 2 (Type A) 6XV1840-2AH10
Optical media modules		4-core, shielded TP installation cable for connection to IE FC Outlet RJ45/IE FC RJ45 Plug; PROFINET-compatible; with UL approval; sold by the meter; max. length 1000 m, minimum order quantity 20 m
with 2 x 100 Mbps BFOC ports, optical <ul style="list-style-type: none"> MM991-2 multimode, glass, up to 5 km MM991-2LD singlemode, glass, up to 26 km MM991-2FM multi-mode, glass, up to 5 km with fiber-optic cable diagnostics 	6GK5991-2AB00-8AA0	IE FC RJ45 Plug 4 x 2
	6GK5991-2AC00-8AA0	RJ45 plug-in connector for Industrial Ethernet (10/100/1000 Mbps) with a rugged metal enclosure and integrated insulation displacement contacts for connecting Industrial Ethernet FC installation cables; 180° cable outlet; for network components and CPs/CPUs with Industrial Ethernet interface
	6GK5991-2AB01-8AA0	• 1 pack = 1 unit 6GK1901-1BB12-2AA0
with 2 x 100 Mbps SC ports, optical <ul style="list-style-type: none"> MM991-2 multimode, glass, up to 5 km MM991-2LD singlemode, glass, up to 26 km MM991-2LH+ singlemode, glass, up to 70 km 	6GK5991-2AD00-8AA0	IE FC M12 Plug PRO 4x2
	6GK5991-2AF00-8AA0	M12 plug-in connector suitable for on-site assembly (X-coded, IP65/IP67), metal enclosure, insulation displacement fast connection method, for SCALANCE W
	6GK5991-2AE00-8AA0	• 1 unit 6GK1901-0DB30-6AA0
with 2 x 100 Mbps SC RJ ports, optical <ul style="list-style-type: none"> MM991-2P PO fiber-optic cable up to 50 m 	6GK5991-2AH00-8AA0	IE M12 Panel Feedthrough 4x2
	6GK5992-2AL00-8AA0	Control cabinet feedthrough for conversion from M12 connection method (X-coded, IP65/IP67) to RJ45 connection method (IP20)
	6GK5992-2AL00-8FA0	• 1 pack = 5 units 6GK1901-0DM40-2AA5
	6GK5992-2AM00-8AA0	IE FC M12 Cable Connector PRO 4x2
	6GK5992-2AN00-8AA0	M12 plug-in connector suitable for on-site assembly (X-coded, IP65/IP67, female contact insert), metal enclosure, insulation displacement fast connection method
	6GK5992-2AP00-8AA0	• 1 unit 6GK1901-0DB40-6AA0
	6GK5992-2AQ00-8AA0	
with 2 x 100/1000 Mbps for SFP plug-in transceiver, optical <ul style="list-style-type: none"> MM992-2SFP for SFP pluggable transceivers with 1 x 100 or 1 x 1000 Mbps multimode or singlemode, glass 	6GK5992-2AS00-8AA0	

SIMATIC PCS 7 system hardware

Industrial communication

Industrial Ethernet

SCALANCE XR-300 switches > Media modules for SCALANCE XR-300

Ordering data	Article No.	Article No.
IE FC TP Standard Cable GP 4 x 2 8-core, shielded TP installation cable for universal applications; with UL approval; sold by the meter; max. length per delivery unit 1000 m, minimum order 20 m	6XV1878-2A	Multi-mode FO BFOC connector set For FO Standard Cable (50/125/1400), FO Ground Cable (50/125/1400), flexible FO Trailing Cable, INDOOR FC Cable (62.5/125/900), 20 units
IE Connecting Cable IE FC RJ45 Plug-180/IE FC RJ45 Plug-180 Preassembled IE FC TP Trailing Cable GP 2 x 2 (PROFINET type C) with two IE FC RJ45 Plug-180, IP20 degree of protection Length: <ul style="list-style-type: none"> • 1.0 m • 5.0 m • 10.0 m 	6XV1871-5BH10 6XV1871-5BH50 6XV1871-5BN10	
IE TP Cord RJ45/RJ45 TP cable 4 x 2 with two RJ45 connectors <ul style="list-style-type: none"> • 1 m • 6 m • 10 m 	6XV1870-3QH10 6XV1870-3QH60 6XV1870-3QN10	Multi-mode FO SC duplex connector set For FO Standard Cable (50/125/1400), FO Ground Cable (50/125/1400), flexible FO Trailing Cable, INDOOR FC Cable (62.5/125/900), 10 units
IE SC RJ POF Plug Screw connector for local assembly on POF FOC (1 pack = 20 units)	6GK1900-0MB00-0AC0	
POF Standard Cable GP 980/1000 POF standard cable for fixed routing indoors with PVC sheath; sold by the meter; max. length 1000 m, minimum order 20 m	6XV1874-2A	FO Standard Cable GP 50/125/1400 ^{1) 2)} Multimode cable, sold by the meter; max. length 1000 m; minimum order 20 m
IE SC RJ PCF Plug Screw connector for local assembly on PCF FOC (1 pack = 10 units)	6GK1900-0NB00-0AC0	
PCF Standard Cable GP 200/230 Standard cable, segmentable, sold by the meter; max. length 2000 m; minimum order 20 m	6XV1861-2A	1) Special fiber-optic cables, lengths and accessories available on request 2) Special tools and trained personnel are required for pre-assembling glass fiber-optic cables
FC FO Termination Kit Termination Kit for local assembly of FC SC and FC BFOC connectors to FC FO Standard Cable, comprising a stripping tool, Kevlar cutters, fiber breaking tool and microscope	6GK1900-1GL00-0AA0	
FC BFOC Plug Screw connector for on-site assembly on FC fiber-optic cable; (1 pack = 20 units + cleaning cloths)	6GK1900-1GB00-0AC0	
FC SC Plug Screw connector for on-site assembly on FC fiber-optic cable; (1 pack = 10 duplex plugs + cleaning cloths)	6GK1900-1LB00-0AC0	
FC FO Standard Cable GP 62.5/200/230 FC FO Standard Cable for fixed routing indoors with PVC sheath; sold by the meter; max. length 1000 m; minimum order 20 m	6XV1847-2A	

Overview



The SCALANCE XR-300WG product line (work group switches) are Industrial Ethernet switches for industry-related applications such as control rooms and applications in the industry-related sector. They enable the configuration of electrical and optical line, star and ring topologies with transmission rates of 10/100/1 000 Mbps as well as 2 x 10 Gbps (SCALANCE XR326-2C PoE WG only) and are designed for installation in 19" control cabinets.

- Up to 28 x electrical interfaces (10/100/1000 Mbps) with RJ45 connections; of which 4 x combo ports for the connection of optical interfaces (1000 Mbps) with SFPs
- High-speed media redundancy through integrated redundancy manager both for Gigabit Ethernet (with SCALANCE X-200, X-300, XM-400, XR-500) and Fast Ethernet (e.g. in combination with SCALANCE XB-200 switches)
- Seamless integration of automation networks in existing corporate networks since a large number of IT standard functions are supported (VLANs, IGMP Snooping/Querier, STP/RSTP, Quality of Service)
- Redundant integration into higher-level networks thanks to support for standardized redundancy procedures (Spanning Tree Protocol/Rapid Reconfiguration Spanning Tree Protocol/MRP)
- Remote diagnostics with integrated system diagnostics over PROFINET, web browser, NMS, CLI or SNMP
- Version with PoE support (24x 10/100/1000 Mbps PoE ports) and 2x 10 Gbps combo PoE ports

Benefits

g e t Designed for Industry

- Flexible network design through integrated combo ports that can be used both as copper (RJ45) and FO ports (SFP).
- High availability of the network thanks to:
 - Redundant voltage infeed (only with 24 V DC)
 - Redundant network structures based on fiber-optic or twisted-pair cables (redundancy manager and STP/RSTP function integrated)
 - Extremely fast network reconfiguration in the event of a fault (MRP: 200 ms)
- Protection of investment through integration into existing network management systems, such as SINEC NMS, by means of standardized SNMP access
- Time saving during engineering, commissioning and in the operating phase of a plant by using the integrated configuration and diagnostics in STEP 7, without additional software
- Space savings in the control cabinet through shallow overall depth, so that 19" control cabinets can be populated from both sides with SCALANCE XR-300WG switches. Recess for insertion and installation on a 35 mm DIN rail
- Easy and cost-saving supply of connected cameras (e.g. SIMATIC MV500 IP or Ident cameras), WLAN access points (e.g. SCALANCE W) or localization components (e.g. SIMATIC RTLS gateways) with data and power on a single cable by using the PoE standard (Power over Ethernet, XR326-2C PoE WG)
- Optimal use of PoE power budget through PoE Power Management. The available PoE power budget can be distributed by the user to the PoE ports
- Realization of high-performance networks over long distances

SIMATIC PCS 7 system hardware

Industrial communication

Industrial Ethernet

SCALANCE XR-300 WG switches

Design

The SCALANCE XR-300WG Industrial Ethernet switches with rugged metal enclosures with IP30 degree of protection are optimized for installation in the 19" control cabinet. 24 V DC and 100 ... 240 V AC versions are available in just one height, 19".

The switches feature:

- 2 x 2-pin terminal block for redundant power infeed for protection against power failure in the 24 V DC version
- 3-pin IEC plug interface for non-heating apparatus for voltage infeed in the 100 ... 240 V AC version
- Status information at the port for local diagnostics (link status, data traffic)
- A RESET button for resetting the device
- A console port (serial interface) for on-site parameter assignment/diagnostics (RJ11 cable to RS 232 not included in scope of delivery)

The SCALANCE XR-300WG switches are available with the following port types:

- Electrical RJ45 interfaces that support 10/100 Mbps or 10/100/1 000 Mbps depending on the device version
- Optical SFP interfaces that can be used for multimode or single-mode SFPs for transmission of 1 000 Mbps (combo ports). With the PoE version, the SFP interfaces of the combo ports support both 1 000 Mbps SFPs and 10 000 Mbps SFP+.

Product versions

SCALANCE XR324WG

With 24 x 10/100 Mbps ports and redundant 24 V DC power supply

SCALANCE XR324WG

With 24 x 10/100 Mbps ports and 100 ... 240 V AC power supply

SCALANCE XR328-4C WG

With 24 x 10/100 Mbps ports, 4 x combo ports and redundant 24 V DC power supply

SCALANCE XR328-4C WG

With 24 x 10/100 Mbps ports, 4 x combo ports and 100 - 240 V AC power supply

SCALANCE XR328-4C WG

With 24 x 10/100 Mbps ports, 4 x combo ports and 24 V DC power supply
Reduced number of approvals (no UL/FM approval)

SCALANCE XR328-4C WG

With 24 x 10/100 Mbps ports, 4 x combo ports and 100 - 240 V AC power supply
Reduced number of approvals (no UL/FM approval)

SCALANCE XR328-4C WG

With 24 x 10/100/1 000 Mbps ports, 4 x combo ports and redundant 24 V DC power supply

SCALANCE XR328-4C WG

With 24 x 10/100/1 000 Mbps ports, 4 x combo ports and 100 - 240 V AC power supply

SCALANCE XR326-2C PoE WG

With 24 x 10/100/1 000 Mbps PoE ports (max. 30W, IEEE802.3at), 2 x combo PoE port (max. 60W at the RJ45 port, IEEE802.3bt combined with 1G/10G SFP+ port) and 100 - 240 V AC power supply. Maximum PoE power in the device 200 W. PoE power can be expanded to 600 W by using additional power supply units.

Ordering data

Article No.

SCALANCE XR-300WG Industrial Ethernet Switches

19" Industrial Ethernet switches for setting up electrical and/or optical Industrial Ethernet networks; depending on the device version, ports support 10/100 Mbps or 10/100/1 000 Mbps Ethernet (non-blocking), integrated redundancy manager, RSTP, RMON, IGMP Snooping/Querier, network management via SNMP, PROFINET, and web server

SCALANCE XR324WG

With 24 x 10/100 Mbps ports and redundant 24 V DC power supply

6GK5324-0BA00-2AR3

With 24 x 10/100 Mbps ports and 230 V AC power supply

6GK5324-0BA00-3AR3

SCALANCE XR328-4C WG

With 24 x 10/100 Mbps ports, 4 x combo ports and redundant 24 V DC power supply

6GK5328-4FS00-2AR3

With 24 x 10/100 Mbps ports, 4 x combo ports and 230 V AC power supply

6GK5328-4FS00-3AR3

SCALANCE XR328-4C WG

With 24 x 10/100 Mbps ports, 4 x combo ports and redundant 24 V DC power supply
Reduced number of approvals (no UL/FM approval)

6GK5328-4FS00-2RR3

With 24 x 10/100 Mbps ports, 4 x combo ports and 230 V AC power supply
Reduced number of approvals (no UL/FM approval)

6GK5328-4FS00-3RR3

SCALANCE XR328-4C WG

With 24 x 10/100/1 000 Mbps ports, 4 x combo ports and redundant 24 V DC power supply

6GK5328-4SS00-2AR3

With 24 x 10/100/1 000 Mbps ports, 4 x combo ports and 230 V AC power supply

6GK5328-4SS00-3AR3

SCALANCE XR326-2C PoE WG

With 24 x 10/100/1 000 Mbps PoE ports (30 W), 2 x combo PoE port (max. 60W at the RJ45 port, 1G/10G at the SFP+ port) and 100 - 240 V AC power supply

6GK5326-2QS00-3AR3

With 24 x 10/100/1 000 Mbps PoE ports (30 W), 2 x combo PoE port (max. 60W at the RJ45 port, 1G/10G at the SFP+ port) and 100 - 240 V AC power supply (No UL/FM approval)

6GK5326-2QS00-3RR3

Ordering data	Article No.	Article No.
Accessories		
Plug-in Transceivers – SFPs	See "Plug-in Transceivers for SCALANCE"	
Power supply unit		
SCALANCE PS598-1 Power Supply	6GK5598-1AA00-3AA0	
Power supply 300 W Input: 85-264 V AC IEC plug; Output: 24 V DC terminals or for direct connection to SCALANCE XR-300WG		
SCALANCE PSR9230PoE	6GK5923-0PS00-2RA3	
Rack PoE power supply with Input 110-240 V AC, Output 54 V DC		
Small Form-Factor Pluggable (SFP)		
SFPs with LC connection for use in SCALANCE XR108-2PoE WG; glass fiber-optic SFPs in single-mode and multimode, 1 000 or 10 000 Mbps		
<ul style="list-style-type: none"> • SFP993-1, 1x 10 Gbps, Multimode • SFP993-1LD, 1x 10 Gbps, Single-mode • SFP993-1LH, 1x 10 Gbps, Single-mode • Pre-assembled IE cable with 2x SFPs, 1 m • Pre-assembled IE cable with 2x SFPs, 2 m • Pre-assembled IE cable with 2x SFPs, 3 m 	6GK5993-1AT00-8AA0 6GK5993-1AU00-8AA0 6GK5993-1AV00-8AA0 6GK5980-3CB00-0AA1 6GK5980-3CB00-0AA2 6GK5980-3CB00-0AA7	
See accessories for XR108-2PoE WG for further 1 Gbps SFPs		
IE FC RJ45 Plug 180 2 x 2	6GK1901-1BB10-2AA0	
Industrial Ethernet FastConnect RJ45 plug 180 2x2, RJ45 connector (10/100 Mbps) with rugged metal enclosure and FC connection technology, for IE FC cable 2x2 180° cable outlet 1 pack = 1 unit		
IE FC RJ45 Plug 4x2	6GK1901-1BB11-2AA0	
RJ45 plug-in data connector (10/100/1 000 Mbps), for connection to IE FC TP cables 4x2, with rugged metal enclosure and FastConnect connection technology		
IE FC TP Standard Cable GP 2 x 2 (Type A)	6XV1840-2AH10	
4-wire, shielded TP installation cable for connection to IE FC RJ45 outlet/IE FC RJ45 plug; PROFINET-compliant; with UL approval; sold by the meter; max. delivery unit 1 000 m, minimum order quantity 20 m, also available as pre-assembled cable with RJ45 connectors in various lengths		
	IE FC TP Standard Cable GP 4X2	6XV1878-2A
	TP installation cable Cat6 for connecting to IE FC RJ45 plug 4x2, AWG 24 sold by the meter; max. delivery unit 1 000 m; minimum order quantity 20 m, also available pre-assembled with RJ45 plugs in various lengths	
	FO Standard Cable GP 50/125/1400	6XV1873-2A
	Multimode cable, sold by the meter; max. delivery unit 1 000 m; minimum order quantity 20 m, also available pre-assembled with ST/BFOC, SC and LC connectors in various lengths	
	SCALANCE TAP104	6GK5104-0BA00-1SA2
	Test access port for the reaction- free extraction of Ethernet data frames (10/100 Mbps) from both transmission directions; extracts complete data traffic (including incomplete diagrams) for further diagnostics	
	Notes:	
	<ul style="list-style-type: none"> • You can find more information on the FastConnect range in the https://support.industry.siemens.com/cs/document/109766358/ordering-overview-cabling-technology-for-communication-networks-in-industry?dti=0&lc=en-DE ordering overview • You can order supplementary components for the SIMATIC NET cabling range from your local contact. Technical advice on this subject is available from: J. Hertlein DI PA CI PRM 4 Tel.: +49 (172) 3172810 Email: juergen.hertlein@siemens.com 	

SIMATIC PCS 7 system hardware

Industrial communication

Industrial Ethernet

SCALANCE XM-400 switches

Overview



The SCALANCE XM-400 product range comprises modular Industrial Ethernet switches which can be expanded with a variety of port extenders and plug-in transceivers for a maximum configuration with up to 24 ports. It supports 10/100/1000 Mbps technology for various transmission media (twisted-pair, fiber-optic) and increased port requirements. The main applications are high-performance plant networks (control level).

- Combo ports for the flexible use of interfaces: A combo port consists of an electric port and an SFP slot. Only one of the two ports can ever be active. If an SFP plug-in transceiver is inserted, the electric port is deactivated
- Fast mobile diagnosis with smartphone/tablet thanks to WLAN and NFC: Fast access to the web-based management of the SCALANCE XM-400 via mobile websites. The function can be started using existing WLAN and NFC (Near Field Communication)
- High-speed media redundancy through integral redundancy manager even for large networks, for both Gigabit Ethernet and Fast Ethernet
- Remote diagnostics with integrated system diagnostics over PROFINET, CLI, SINEMA Server or SINEC NMS, web browser or SNMP
- Integration into STEP 7/TIA Portal including up/downloading of the configuration
- Seamless integration of automation networks into existing corporate networks since numerous IT standards are supported: Setup of virtual networks (VLAN)
- Integration into higher-level enterprise networks thanks to support for standardized redundancy procedures (Rapid Spanning Tree Protocol, Link Aggregation)
- By learning the multicast sources and destinations (Internet Group Management Protocol (IGMP) Snooping), SCALANCE XM-400 switches can also filter multicast data traffic, thus limiting the load on the network.
- Optional activation of the Layer 3 functions for IPv4 and IPv6 in connection with the KEY-PLUG XM-400. For a detailed description, see "Accessories for Layer 3 switches/routers"
- Creation of IP subnetworks and IP router communication by means of Layer 3 switching (IP routing)
 - Static routing
 - Dynamic routing OSPF (Open Shortest Path First) and RIPv2 (Routing Information Protocol)
 - Redundant routing VRRP (Virtual Router Redundancy Protocol)

Product variants — basic devices

Basic devices with eight to 16 integrated Gigabit Ethernet twisted-pair interfaces (10/100/1000 Mbps), in each case as Layer 2 versions for subsequent optional activation of Layer 3 functions (routing) via KEY-PLUG and as Layer 3 versions with integrated routing functionality.

XM416-4C

- 16 ports available in total, of which
 - Up to 16 x 10/100/1000 Mbps are RJ45 ports with retaining collars
 - Up to 4 x SFP slots (combo ports), 100 or 1000 Mbps
- A port extender with 8 ports can be connected to implement a maximum of 24 ports in one switch

XM408-8C

- 8 ports available in total, of which
 - Up to 8 x 10/100/1000 Mbps are RJ45 ports with retaining collars
 - Up to 8 x SFP slots (combo ports), 100 or 1000 Mbps
- Two port extenders with 8 ports each can be connected to implement a maximum of 24 ports in one switch

XM408-4C

- 8 ports available in total, of which
 - Up to 8 x 10/100/1000 Mbps are RJ45 ports with retaining collars
 - Up to 4 x slots (combo ports) for plug-in transceivers ("pluggables") with SC connection method (1000 Mbps) or ST/BFOC connection method (100 Mbps)
- Two port extenders with 8 ports each can be connected to implement a maximum of 24 ports in one switch

Benefits



- Modular system permits cost savings. The modular system facilitates easy setup of electrical and optical Industrial Ethernet networks as well as modification of the network topology and port type to suit the plant structure, with expansion possible at any time
- Integrated industrial network for data, speech, and video
- High performance due to up to 24 Gigabit ports
- Operational reliability in industrial environments, e.g. due to robust enclosure, redundancy, temperature range from -40 °C to +70 °C
- Increased plant availability thanks to:
 - Redundant power supply
 - Redundant network structures based on fast media redundancy
 - Standby redundancy between ring topologies
 - Redundant switching through standard mechanisms STP, RSTP, MSTP
 - Redundant router operation through VRRP
 - Media modules can be replaced or expanded during operation
 - Easy device replacement due to plug-in KEY-PLUG/C-plug removable data storage medium
- Virtual networks (VLAN) allow simple division of large networks into smaller subnetworks with their own address space. Reasons for subdivision into subnetworks include separation of the Ethernet networks to reduce the broadcast load, separation of sensitive areas from the main network, and subdivision of the network into logical working groups. Communication between the VLANs can, however, be achieved with Layer-3-Switching (IP routing)
- Integrated and optional security functions offer protection against unauthorized network access and configuration
- Simple monitoring and diagnostics by means of signaling contact, SNMP traps, integrated system diagnostics with PROFINET and email function
- Integration into the SINEMA Server or SINEC NMS network management system for integrated network diagnostics with central firmware management
- Reduced engineering expenditure for PLC/HMI due to integration into the SIMATIC system fault message concept
- Integrated configuration and diagnostics in the TIA Portal
- Fast mobile diagnostics with smartphone/tablet thanks to WLAN and NFC (Near Field Communication): Fast access to the web-based management of the SCALANCE XM-400 via mobile websites. The function can be started using existing WLAN and NFC.

Design

SCALANCE XM-400

SCALANCE XM-400 with up to 24 Gigabit ports is an Industrial Ethernet switch with robust, industry-standard enclosure, for mounting onto standard rails, and designed IP20 protection.

SCALANCE XM-400 basic devices offer the following additional interfaces

- Console port (serial interface RJ11) and management port (100 Mbit/s, RJ45) for on-site parameterization/diagnostics and firmware update
- Slot for optional C-PLUG swap medium for simple device replacement (included in scope of delivery) or KEY-PLUG for optional software expansion to Layer-3 Switching
- Floating signaling contact can be freely configured to indicate fault events, for example
- Extensive operating mode and status information is displayed via LEDs and selection pushbuttons
- Grounding bolts for defined ground connection
- Two infeeds are available for protection against voltage failure
- Connection for a port extender on the right (tool-free installation)

SIMATIC PCS 7 system hardware

Industrial communication

Industrial Ethernet

SCALANCE XM-400 switches

Ordering data

SCALANCE XM-400 Industrial Ethernet Switches

With eight to 16 integrated Gigabit Ethernet twisted-pair interfaces (10/100/1 000 Mbps) 24 x 1 000 Mbps maximum overall configuration by means of port extenders

Integrated redundancy manager IT functions (RSTP, VLAN, etc.) PROFINET IO device, network management via SNMP and web server; incl. operating instructions, Industrial Ethernet network manual and configuration software on DVD-ROM C-PLUG included in scope of supply

SCALANCE XM416-4C;

16 x 10/100/1 000 Mbps, of which 4 x RJ45/SFP combo ports; 16 x 1 000 Mbps maximum basic device configuration

- IP routing in combination with KEY-PLUG XM-400
- IP routing integrated

SCALANCE XM408-8C;

8 x 10/100/1 000 Mbps, of which 8 x RJ45/SFP combo ports; 8 x 1 000 Mbps maximum basic device configuration

- IP routing in combination with KEY-PLUG XM-400
- IP routing integrated

SCALANCE XM408-4C

8 x 10/100/1 000 Mbps, of which 4x RJ45/ST or SC plug-in transceiver combo ports; 8x 1 000 Mbps maximum basic device configuration

- IP routing in combination with KEY-PLUG XM-400
- IP routing integrated

Accessories

Power Supplies

SIMATIC PM 1507 24 V
stabilized power supply for SIMATIC S7-1500

- Power supply S7-1500 PM1507
SIMATIC PM 1507 24 V/3 A stabilized power supply for SIMATIC S7-1500
Input: 120/230 V AC
Output: 24 V DC/3 A
- Power supply S7-1500 PM1507
SIMATIC PM 1507 24 V/8 A stabilized power supply for SIMATIC S7-1500
Input: 120/230 V AC
Output: 24 V DC/8 A
- PoE power supplies for SCALANCE XM-400
SCALANCE PS9230 PoE power supply for Power-over-Ethernet
Input: 120/230 V AC
Output: 54 V DC/1.6 A NEC Class 2
- PoE power supplies for SCALANCE XM-400
SCALANCE PS924 PoE power supply for Power-over-Ethernet
Input: 24 V DC
Output: 54 V DC/1.6 A NEC Class 2

Article No.

6GK5416-4GS00-2AM2

6GK5416-4GR00-2AM2

6GK5408-8GS00-2AM2

6GK5408-8GR00-2AM2

6GK5408-4GP00-2AM2

6GK5408-4GQ00-2AM2

6EP1332-4BA00

6EP1333-4BA00

6GK5923-0PS00-3AA2

6GK5924-0PS00-1AA2

Article No.

Port extender for SCALANCE XM-400

See "Port Extender for SCALANCE XM-400 managed"

Plug-in Transceivers – SFPs

See "Plug-in Transceivers for SCALANCE"

IE FC RJ45 Plug 4 x 2

IE FC RJ45 plug 180 4 x 2; RJ45 connector; Cat6A; (10/100/1 000/10 000 Mbps) with rugged metal enclosure; FC connection method; for IE FC cable 4 x 2 (AWG 24); 180° cable outlet

- 1 pack = 1 unit

6GK1901-1BB12-2AA0

IE FC TP Standard Cable GP 4 x 2

6XV1878-2A

TP installation cable Cat6 for connecting to IE FC RJ45 plug 4x2, AWG 24, 8-wire, shielded TP installation cable for universal applications; with UL approval sold by the meter; max. delivery unit 1 000 m; minimum order quantity 20 m, also available pre-assembled with RJ45 connectors in various lengths

FO Standard Cable GP 50/125/1400^{1) 2)}

6XV1873-2A

Multimode cable, sold by the meter; max. delivery unit 1 000 m, minimum order quantity 20 m, also available pre-assembled with ST/BFOC, SC and LC connectors in various lengths

C-PLUG

Removable data storage medium for simple replacement of devices in the event of a fault; for storing configuration or application data; can be used for SIMATIC NET products with C-PLUG slot

6GK1900-0AB10

SCALANCE TAP104

6GK5104-0BA00-1SA2

Test access port for the reaction-free extraction of Ethernet data frames (10/100 Mbps) from both transmission directions; extracts complete data traffic (including incomplete diagrams) for further diagnostics

Notes:

- You can find more information on the FastConnect range in the <https://support.industry.siemens.com/cs/document/109766358/ordering-overview-cabling-technology-for-communication-networks-in-industry?dti=0&lc=en-DE> ordering overview
- You can order supplementary components for the SIMATIC NET cabling range from your local contact. Technical advice on this subject is available from: J. Hertlein
DI PA CI PRM 4
Tel.: +49 (172) 3172810
E-mail: juergen.hertlein@siemens.com

Overview



- Port extender for flexible expansion to up to 24 ports, can be connected to the SCALANCE XM-400 Industrial Ethernet switches
- Each port extender has eight ports
- There are three different versions, with different connections

Product versions

PE400-8SFP

- 8 x SFP slots, 100 or 1000 Mbps
- Extended operating temperature range from -40 °C to +60 °C

PE408

- 8 x 10/100/1000 Mbps RJ45 ports with retaining collar
- Extended operating temperature range from -40 °C to +70 °C

PE 408PoE

- 8 x 10/100/1000 Mbps RJ45 ports with retaining collar with PoE according to IEEE802.3 Type 1 and Type 2
- Extended operating temperature range from -40 °C to +60 °C
- A separate power supply is required for PoE power (SCALANCE PS924 PoE or SCALANCE PS9230 PoE are available)

Benefits

get Designed for Industry

- Modular system permits cost savings. The modular system facilitates easy setup of electrical and optical Industrial Ethernet networks as well as modification of the network topology and port type to suit the plant structure, with expansion possible at any time
- Integrated industrial network for data, speech, and video
- Mounting of a port extender on the basic device or another port extender without tools
- High performance due to Gigabit ports

Design

- Extender connection on the left for connection to a SCALANCE XM-400 basic device or a port extender
- Extender connection on the right for connecting another port extender
- 8 ports for Ethernet connection, different design depending on the version
- LEDs to display the port and device status
- 2 terminal blocks for Power-over-Ethernet supply with 54 V DC input (only PE408PoE)
- Operating temperature range from -40 °C to +70 °C
- IP20 degree of protection

Ordering data

Article No.

Port extender for SCALANCE XM-400

- PE400-8SFP; with 8 slots for 100/1000 Mbps SFP plug-in transceivers
- PE408; with 8 x 10/100/1000 Mbps TP ports
- PE408PoE; with 8 x 10/100/1000 Mbps TP ports Power over Ethernet according to 802.3at Type 1/2

6GK5400-8AS00-8AP2

6GK5408-0GA00-8AP2

6GK5408-0PA00-8AP2

Accessories

IE FC Stripping Tool

Pre-adjusted stripping tool for fast stripping of Industrial Ethernet FC cables

6GK1901-1GA00

IE FC RJ45 Plug 180 2 x 2

180° cable outlet; for network components and CPs/CPU with Industrial Ethernet interface

- 1 pack = 1 unit

6GK1901-1BB10-2AA0

IE FC TP Standard Cable GP 2 x 2 (Type A)

4-core, shielded TP installation cable for connection to IE FC Outlet RJ45/IE FC RJ45 Plug; PROFINET-compliant; with UL approval; sold by the meter; max. length 1000 m, minimum order quantity 20 m

6XV1840-2AH10

IE FC RJ45 Plug 4 x 2

RJ45 plug-in connector for Industrial Ethernet (10/100/1000 Mbps) with a rugged metal enclosure and integrated insulation displacement contacts for connecting Industrial Ethernet FC installation cables; 180° cable outlet; for network components and CPs/CPU with Industrial Ethernet interface

- 1 pack = 1 unit

6GK1901-1BB11-2AA0

IE FC TP Standard Cable GP 4 x 2

8-core, shielded TP installation cable for universal applications; with UL approval; sold by the meter; max. length per delivery unit 1000 m, minimum order 20 m

6XV1878-2A

- AWG24, for connecting to IE FC RJ45 Plug 4 x 2, IE FC M12 Plug PRO 4 x 2

SIMATIC PCS 7 system hardware

Industrial communication

Industrial Ethernet

SCALANCE XM-400 switches > Port extender for SCALANCE XM-400

Ordering data	Article No.	Ordering data	Article No.
IE Connecting Cable IE FC RJ45 Plug-180/IE FC RJ45 Plug-180 Preassembled IE FC TP Trailing Cable GP 2 x 2 (PROFINET type C) with two IE FC RJ45 Plug-180, IP20 degree of protection Length: <ul style="list-style-type: none"> • 1.0 m • 5.0 m • 10.0 m 	6XV1871-5BH10 6XV1871-5BH50 6XV1871-5BN10	Pre-assembled FO patch cables <u>Multimode</u> MM FO Cord SC/LC With one SC duplex connector and one LC duplex connector, 1 m MM FO Cord SC/BFOC With one SC duplex connector and two BFOC connectors, 1 m MM FO Cord SC/SC With two SC duplex connectors, 1 m <u>Single-mode</u> SM FO Cord SC/LC With one SC duplex connector and one LC duplex connector, 1 m SM FO Cord SC/BFOC With one SC duplex connector and two BFOC connectors, 1 m SM FO Cord SC/SC With two SC duplex connectors, 1 m	6XV1843-5EH10-OCA0 6XV1843-5EH10-OCB0 6XV1843-5EH10-OCC0 6XV1843-5FH10-OCA0 6XV1843-5FH10-OCB0 6XV1843-5FH10-OCC0
FC FO Termination Kit Termination Kit for local assembly of FC SC and FC BFOC connectors to FC FO Standard Cable, comprising a stripping tool, Kevlar cutters, fiber breaking tool and microscope	6GK1900-1GL00-0AA0	Other accessories Spring-loaded terminal block Spring-type terminal block for SCALANCE X/W/S/M; 1 pack = 5 units <ul style="list-style-type: none"> • 2-pole for signaling contact (24 V DC) Screw for fixing to S7-1500 and S7-300 rails Mounting screw for SCALANCE X/W/S/M; 1 pack = 5 items	6GK5980-0BB10-0AA5 6GK5980-4AA00-0AA5
FC BFOC Plug Screw connector for on-site assembly on FC fiber-optic cable; (1 pack = 20 units + cleaning cloths)	6GK1900-1GB00-0AC0		
FC SC Plug Screw connector for on-site assembly on FC fiber-optic cable; (1 pack = 10 duplex plugs + cleaning cloths)	6GK1900-1LB00-0AC0		
FC FO Standard Cable GP 62.5/200/230 FC FO Standard Cable for fixed routing indoors with PVC sheath; sold by the meter; max. length 1000 m; minimum order 20 m	6XV1847-2A		
Multi-mode FO BFOC connector set For FO Standard Cable (50/125/1400), FO Ground Cable (50/125/1400), flexible FO Trailing Cable, INDOOR FC Cable (62.5/125/900), 20 units	6GK1901-0DA20-0AA0		
Multi-mode FO SC duplex connector set For FO Standard Cable (50/125/1400), FO Ground Cable (50/125/1400), flexible FO Trailing Cable, INDOOR FC Cable (62.5/125/900), 10 units	6GK1901-0LB10-2AA0		
LC Plug MM²⁾	6GK1901-0RB10-2AB0		
FO Standard Cable GP 50/125/1400^{1) 2)} Multimode cable, sold by the meter; max. length 1000 m; minimum order 20 m	6XV1873-2A		

- 1) Special fiber-optic cables, lengths and accessories available on request
- 2) Special tools and trained personnel are required for pre-assembling glass fiber-optic cables

Overview



The SCALANCE PS924 PoE and SCALANCE PS9230 PoE power supplies have an output voltage of 54 V DC, a special requirement for PoE (Power-over-Ethernet) according to IEEE 802.3at. With PoE, both data and supply voltage is transmitted from the switch to the connected node via a single cable. Examples of typical nodes, so-called powered devices (PD), are WLAN access points, RFID readers, SIMATIC RTLS gateways, OID and IP cameras, IP telephones, etc.

- Both SCALANCE PS924 PoE and SCALANCE PS9230 PoE power supplies can be installed on standard mounting rails and are designed with IP20 degree of protection for use in control cabinets.
- They are especially suited for use in demanding environments for an operating temperature range from -40 °C to +70 °C.
- The SCALANCE PS924 PoE and SCALANCE PS9230 PoE power supplies are ideal for use in products from the SCALANCE X switch series.
- Versions with 24 V DC or 100 – 240 V AC (50/60 Hz) input voltage are available

Product variants

SCALANCE PS924 PoE Power Supply

- Input voltage range from 19 to 29 V DC
- Output voltage 54 V DC
- 86 W output power
- Operating temperature from -40 °C to +70 °C
- IP20 degree of protection

SCALANCE PS9230 PoE Power Supply

- Input voltage range from 85 to 264 V AC (50/60 Hz)
- Output voltage 54 V DC
- 86 W output power
- Operating temperature from -40 °C to +70 °C
- IP20 degree of protection

Benefits

g e t Designed for Industry

- Reduced wiring effort since data line used transmit supply voltage as well (Power-over-Ethernet)
- High performance provided for connected PDs (up to 30 W)
- Flexible input voltage due to two available versions (24 V DC or 100–240 V AC) (50/60 Hz)
- High availability, suitable for use in harsh environments (-40 °C to 70 °C)
- Space-saving due to compact construction and installation on the standard mounting rail
- Simple installation thanks to classification as current source with limit power (LPS / NEC Class 2)

Design

- Operating temperatures from -40 °C to +70 °C
- Compact design
- IP20 degree of protection
- For installation on 35 mm DIN mounting rails in control cabinet
- LED and signaling contact for status display (DC O.K.)

Ordering data

Article No.

SCALANCE Power Supplies for Power-over-Ethernet

Power supplies with an output voltage of 54 V DC, which is especially required for PoE (Power-over-Ethernet) according to IEEE 802.3at, for installation on a standard mounting rail, IP20 degree of protection; NEC Class 2

SCALANCE PS924 PoE

6GK5924-0PS00-1AA2

Input: 24 V DC
Output: 54 V DC/1.6 A;

SCALANCE PS9230 PoE

6GK5923-0PS00-3AA2

Input: 120/230 V AC
Output: 54 V DC/1.6 A;

SIMATIC PCS 7 system hardware

Industrial communication

Industrial Ethernet

SCALANCE XR-500 switches

Overview



The Layer 3-enabled SCALANCE XR-500 Industrial Ethernet switches are modular, high-performance, industry-standard switches for the construction of electrical and optical line, ring and star topologies with data transfer rates of up to 10 Gbps, designed for installation in 19" control cabinets.

- Up to four electrical and/or optical interfaces with 10 Gbps and up to 48 electrical and/or optical interfaces (10/100/1000 Mbps), of which up to 12 electrical PoE interfaces
- Fast media redundancy due to the integrated redundancy manager:
Redundant connection of rings by means of high-speed media redundancy is also possible with SCALANCE XR-500.
- Seamless integration of automation networks into existing corporate networks thanks to support for a host of IT standard functions (VLANs, IGMP Snooping/Query, STP/RSTP/MSTP, Link Aggregation, Quality of Service, IEEE 802.1X and optional static routing, RIP, OSPF, VRRP)
- Integrated system diagnostics over PROFINET, web browser, CLI, SINEMA Server or SINEC NMS and SNMP
- KEY-PLUG as the removable data storage medium for enabling Layer 3 routing functions.
 - For the automatic backup of configuration data.
 - If a fault occurs, it allows fast and simple device replacement of SCALANCE XR-500 components without a Field PG (contains the function of the C-PLUG)
 - Can be used in all Layer 2 versions of SCALANCE XR-500
 - For a detailed description, see "SCALANCE Accessories for Layer 3 Switches/Routers"

Product variants

SCALANCE XR552-12M

- LEDs and ports on the front
- Alternatively: LEDs on the front and ports at the rear
- Connection of power supply unit at rear or above/below the switch
- Four SFP+ slots for equipping with 10 Gigabit Ethernet SFP+ plug-in transceivers, IE connecting cable SFP+/SFP+ or Gigabit SFP plug-in transceivers
- 12x 4-port media module slots
- Available with integrated IP routing functions or for optional extension of IP routing functions by means of KEY-PLUG

SCALANCE XR528-6M

- LEDs and ports on the front
- Alternatively: LEDs on the front and ports at the rear
- Connection of power supply unit at rear or above/below the switch
- Four SFP+ slots for equipping with 10 Gigabit Ethernet SFP+ plug-in transceivers, IE connecting cable SFP+/SFP+ or Gigabit SFP plug-in transceivers
- 6x 4-port media module slots
- Available with integrated IP routing functions or for optional extension of IP routing functions by means of KEY-PLUG

SCALANCE XR526-8C

- Two SFP+ slots for equipping with 10 Gigabit Ethernet SFP+ plug-in transceivers, IE connecting cable SFP+/SFP+ or Gigabit SFP plug-in transceivers
- Eight combo-ports for optional use of optical or electrical interfaces with 10/100/1000 Mbps optically or electrically via SFP plug-in transceiver
- 16 electrical ports operating at 10/100/1000 Mbps
- In total, 26 ports can be used
- Power supply versions 24 V DC and 110 - 240 V AC (integrated)
- Available with integrated IP routing functions or for optional extension of IP routing functions by means of KEY-PLUG

SCALANCE XR524-8C

- Eight combo-ports for optional use of optical or electrical interfaces with 10/100/1000 Mbps optically or electrically via SFP plug-in transceiver
- 16 electrical ports operating at 10/100/1000 Mbps
- In total, 24 ports can be used
- Power supply versions 24 V DC and 110 - 240 V AC (integrated)
- Available with integrated IP routing functions or for optional extension of IP routing functions by means of KEY-PLUG

Benefits

get Designed for Industry

- Unlimited flexibility during network expansions (e.g. more terminals, higher data transfer rates, PoE ports) or conversion (e.g. switching from copper to fiber-optic cable) and reduction of the storage costs due to the fully modular construction using SFPplus/SFP and media modules
- Retrofitting the Layer 3 switching functions (IP routing) by means of a license on KEY-PLUG without replacing the existing hardware
- Changing the media modules during operation
- High availability of the network thanks to:
 - Redundant power supply
 - Redundant network structures based on fiber-optic or twisted pair cables (redundancy manager, standby function and STP/RSTP/MSTP integrated)
 - Easy device replacement by means of C-plug/KEY-PLUG removable data storage medium
 - Extremely fast network reconfiguration in the event of a fault
- High flexibility thanks to variable mounting options of the power supply unit and device variants with ports on either the front or rear of the device.
- Integration into the SINEMA Server or SINEC NMS network management system for integrated network diagnostics with central firmware management

Design

The SCALANCE XR-500 Industrial Ethernet switches with a rugged metal enclosure in IP20 degree of protection are optimized for installation in the 19" control cabinet. The power supply unit (85 to 264 V AC) for power supply to the SCALANCE XR-500, which is also optimized for the 19" cabinet, can either be installed directly at the rear of the SCALANCE XR-500 or connected using connecting cables (installation of the power supply unit in a 19" rack). The data ports of the SCALANCE XR-500 are located optionally either at the front or rear of the device (depending on the device variant).

The switches have:

- 4-pin terminal block on the front for connecting the optionally available power supply unit (85 V to 264 V AC)
- 6-pin connector for assembly of the optionally available power supply unit (85 V to 264 V AC) on the rear
- 2-pin terminal block for connecting the isolated signaling contact for simple display of faults
- Row of LEDs for indicating status information (power, link status, data traffic, power supply, signaling contact)
- SELECT/SET pushbutton for easy setting of the fault signaling contact on the device
- Slot on the side of the device for the C-PLUG removable data storage medium for easy device replacement in the event of a fault, or for the KEY-PLUG for adding IP routing to the device functionality
- Console port (RS 232 serial interface, RJ11 cable to D-sub (9-pin) included in scope of delivery) and management port (Ethernet interface) for on-site parameter assignment/diagnostics

The SCALANCE XR-500 switches are available with the following types of port depending on the device variant:

- Four SFP+ slots for optical SFP+ or SFP plug-in transceivers (multimode and singlemode connections)
 - The SFP+ plug-in transceivers support 10 Gbps
 - The SFP plug-in transceivers support 1000 Mbps
- Up to 12 slots for electrical 4-port media modules and electrical PoE 4-port media modules or optical 4-port media modules for multimode or singlemode connections; the optical media modules are available in various connection technologies
 - The RJ45 sockets are also available in industry-standard design with additional retaining collars for connection of the Industrial Ethernet FC RJ45 Plug 180
 - All electrical Ethernet interfaces support 10/100/1000 Mbps, all optical Ethernet interfaces support 100 or 1000 Mbps

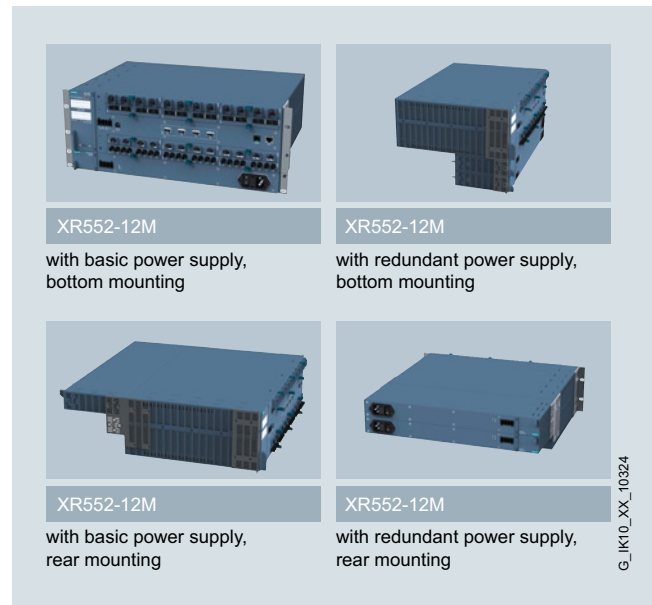

Options for mounting a single/redundant power supply unit to SCALANCE XR552-12M

Ordering data	Article No.
SCALANCE XR-500 Industrial Ethernet Switches Layer 3-enabled Industrial Ethernet switches for establishing electrical and/or optical Industrial Ethernet networks; with data transfer rates up to 10 Gbps, designed for installation in 19" control cabinets	
SCALANCE XR552-12M 4 x integral 1/10 Gbps SFP+ slots for SFP or SFP+ plug-in transceivers 12 x 10/100/1 000 Mbps slots for 4-port media modules, electrical or optical <u>Layer 2, upgrade to Layer 3 possible</u> • Ports at front • Ports at rear <u>Layer 3</u> • Ports at front • Ports at rear	6GK5552-0AA00-2AR2 6GK5552-0AA00-2HR2 6GK5552-0AR00-2AR2 6GK5552-0AR00-2HR2

SIMATIC PCS 7 system hardware

Industrial communication

Industrial Ethernet

SCALANCE XR-500 switches

Ordering data

Article No.

SCALANCE XR528-6M

4 x integral 1/10 Gbps SFP+ slots for SFP or SFP+ plug-in transceivers
6 x 10/100/1 000 Mbps slots for 4-port media modules, electrical or optical

Layer 2, upgrade to Layer 3 possible

- Ports at front
- Ports at rear

Layer 3

- Ports at front
- Ports at rear

6GK5528-0AA00-2AR2
6GK5528-0AA00-2HR2

6GK5528-0AR00-2AR2
6GK5528-0AR00-2HR2

SCALANCE XR526-8C

2 x 10 Gbps
24 x 10/100/1 000 Mbps, of which
8 x RJ45/SFP combo ports
24 x 1 000 Mbps maximum use

Layer 2, upgrade to Layer 3 possible

- Redundant 24 V DC power supply
- Power supply 230 V AC
- Redundant 230 V AC power supply

Layer 3

- Redundant 24 V DC power supply
- Power supply 230 V AC
- Redundant 230 V AC power supply

6GK5526-8GS00-2AR2
6GK5526-8GS00-3AR2
6GK5526-8GS00-4AR2

6GK5526-8GR00-2AR2
6GK5526-8GR00-3AR2
6GK5526-8GR00-4AR2

SCALANCE XR524-8C

24 x 10/100/1 000 Mbps, of which
8 x RJ45/SFP combo ports;
24 x 1 000 Mbps maximum usable

Layer 2, upgrade to Layer 3 possible

- Redundant 24 V DC power supply
- Power supply 230 V AC
- Redundant 230 V AC power supply

Layer 3

- Redundant 24 V DC power supply
- Power supply 230 V AC
- Redundant 230 V AC power supply

6GK5524-8GS00-2AR2
6GK5524-8GS00-3AR2
6GK5524-8GS00-4AR2

6GK5524-8GR00-2AR2
6GK5524-8GR00-3AR2
6GK5524-8GR00-4AR2

Accessories

SCALANCE PS598-1 Power Supply

Power supply 300 W
Input: 85–264 V AC IEC plug
Output: 24 V DC terminals or for direct connection to SCALANCE X-500

6GK5598-1AA00-3AA0

FAN597-1

Replacement fan slide-in unit for SCALANCE XR552-12M

6GK5597-1AA00-8AA0

FAN597-2

Replacement fan slide-in unit for SCALANCE XR528-6M

6GK5597-2AA00-8AA0

C-PLUG

Removable data storage medium for simple replacement of devices in the event of a fault; for storing configuration or engineering and application data; can be used for SIMATIC NET products with C-PLUG slot

6GK1900-0AB10

KEY-PLUG X-500

Removable data storage medium for expansion of the device functions with IP routing (Layer 3), for integration of configuration data and for easy replacement of SCALANCE X-500 in the event of a fault

6GK5905-0PA00

SCALANCE TAP104

Test access port for the reaction-free extraction of Ethernet data frames (10/100 Mbps) from both transmission directions; extracts entire data traffic (including incomplete diagrams) for further diagnostics.

6GK5104-0BA00-1SA2

Media Modules

See "Media modules for modular SCALANCE X-500 managed"

Plug-in Transceivers - SFPs

See "Power supply for modular SCALANCE X-500 managed"

IE FC RJ45 Plug 4x2

RJ45 plug-in data connector (10/100/1 000 Mbps), for connection to IE FC TP cables 4x2, with rugged metal enclosure and FastConnect connection technology

6GK1901-1BB11-2AA0

IE FC TP Standard Cable GP 4X2

TP installation cable Cat6 for connecting to IE FC RJ45 plug 4x2, AWG 24 sold by the meter; max. delivery unit 1000 m; minimum order quantity 20 m, also available pre-assembled with RJ45 connectors in various lengths

6XV1878-2A

FO Standard Cable GP 50/125/1400

Multimode cable, sold by the meter; max. delivery unit 1000 m; minimum order quantity 20 m, also available pre-assembled with ST/BFOC, SC and LC connectors in various lengths

6XV1873-2A

Notes:

- You can find more information on the FastConnect range in the <https://support.industry.siemens.com/cs/document/109766358/ordering-overview-cabling-technology-for-communication-networks-in-industry?dti=0&lc=en-DE> ordering overview
- You can order supplementary components for the SIMATIC NET cabling range from your local contact. Technical advice on this subject is available from:
J. Hertlein
DI PA CI PRM 4
Tel.: +49 (172) 3172810
E-mail: juergen.hertlein@siemens.com

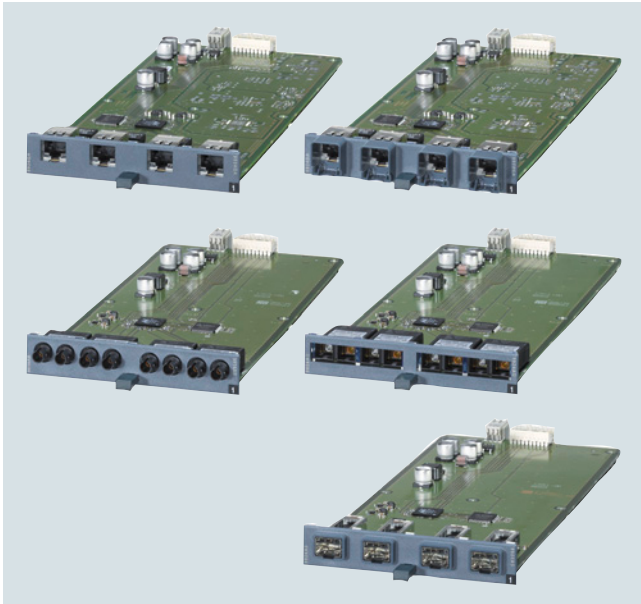
Overview

- 4-port media modules for flexible, 4-port-granular equipping of SCALANCE XR-500 Industrial Ethernet switches
- Electrical versions with RJ45 ports are available as are optical versions with ST/BFOC, SC and LC (via SFPs) for the use of multimode and single-mode fiber-optic cables
- Using a 4-port SFP media module, the optional use of fiber-optic SFP plug-in transceivers (small form-factor pluggable) with LC connection technology is possible

Product variants — media modules

Electrical media modules with 4 x 10/100/1 000 Mbps RJ45 ports

- MM992-4CUC with retaining collar
- MM992-4CU without retaining collar

Electrical media modules with 4 x 10/100/1 000 Mbps RJ45 ports and PoE

- MM992-4PoEC with retaining collar
- MM992-4PoE without retaining collar

Optical media modules with 4 x 100 Mbps ST/BFOC ports

- MM991-4
multimode, glass, up to 5 km
- MM991-4LD
single-mode, glass, up to max. 26 km

Optical media modules with 4 x 1 000 Mbps SC ports

- MM992-4
multimode, glass, up to 750 m
- MM992-4LD
single-mode, glass, up to max. 10 km

Optical media modules with 4 x 100/1 000 Mbps for SFP plug-in transceiver

- MM992-4SFP
For SFP plug-in transceivers with 1 x 100 Mbps or 1 x 1 000 Mbps multimode or single-mode, glass

Benefits

g e t Designed for Industry

- Unlimited flexibility during network expansions (e.g. more terminal devices), conversion (e.g. switching from copper to fiber-optic cables), or performance enhancement (e.g. from Gigabit to 10 Gigabit) through modular construction using media modules and SFP+ or SFP plug-in transceivers
- Reduction of storage costs and maintenance overhead by focusing on a few basic device versions

SIMATIC PCS 7 system hardware

Industrial communication

Industrial Ethernet

SCALANCE XR-500 switches > Media modules for modular SCALANCE XR-500

Design

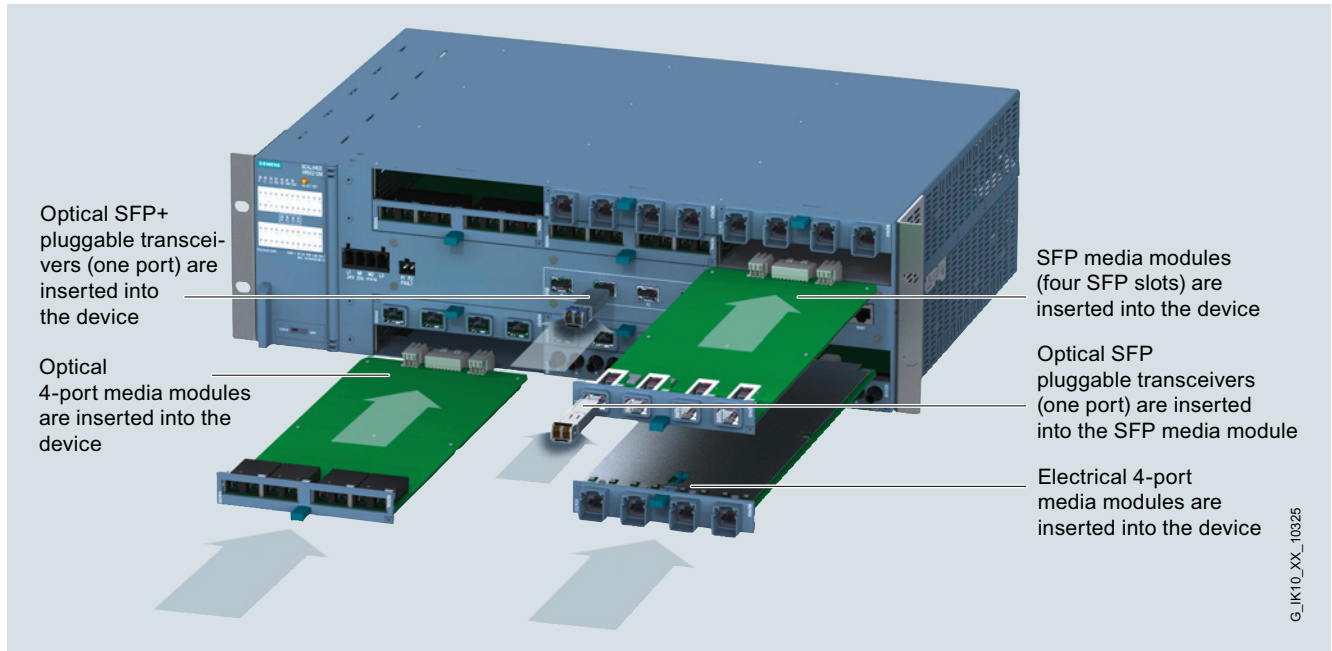

G_IK10_XX_10325

4-port media modules plugged into media module slot and SFP/SFP+ plug-in transceivers in SFP+ slots

		10 Gigabit Ethernet		Gigabit Ethernet			Fast Ethernet				
		10 Gbit/s		10/100/1000 Mbit/s		1000 Mbit/s		100 Mbit/s			
		Optical		Electrical		Optical		Optical		Max. distance	
	Module type	Multimode	Singlemode	Twisted Pair	Multimode	Singlemode	Multimode	Singlemode			
	MM992-4CUC			4x RJ45							100 m
	MM992-4CU ¹⁾			4x RJ45							100 m
	MM992-4PoE C			4x RJ45							100 m
	MM992-4PoE ¹⁾			4x RJ45							100 m
	MM991-4						4x ST/BFOC				5 km
	MM991-4LD							4x ST/BFOC			26 km
	MM992-4				4x SC						750 m
	MM992-4LD					4x SC					10 km
	MM992-4SFP ³⁾				4x LC	4x LC	4x LC	4x LC			²⁾

1) Without retaining collar
 2) Dependent on the kind of cable and cable quality, transmission speed varies with distance
 3) For max. 4x SFP modules

G_IK10_XX_10293

Overview of media modules for SCALANCE X-500

Ordering data	Article No.	Article No.
<p><i>Electrical media modules</i></p> <p>with 4 x 10/100/1000 Mbps RJ45 ports, electrical</p> <ul style="list-style-type: none"> MM992-4CuC MM992-4CU <p>with power over Ethernet</p> <ul style="list-style-type: none"> MM992-4PoEC MM992-4PoE 	<p>6GK5992-4GA00-8AA0</p> <p>6GK5992-4SA00-8AA0</p> <p>6GK5992-4RA00-8AA0</p> <p>6GK5992-4QA00-8AA0</p>	<p>IE FC TP Standard Cable GP 4 x 2</p> <p>8-core, shielded TP installation cable for connection to IE FC RJ45 Modular Outlet for universal application; with UL approval; sold by the meter; max quantity 1000 m, minimum order 20 m</p> <p>6XV1870-2E</p>
<p><i>Optical media modules</i></p> <p>with 4 x 100 Mbps BFOC ports, optical</p> <ul style="list-style-type: none"> MM991-4 multi-mode, glass, up to 5 km MM991-4LD single-mode, glass, up to max. 26 km <p>with 4 x 1000 Mbps SC ports, optical</p> <ul style="list-style-type: none"> MM992-4 multimode, glass, up to 750 m MM992-4LD single-mode, glass, up to max. 10 km <p>with 4 x 100/1000 Mbps for SFP pluggable transceiver, optical</p> <ul style="list-style-type: none"> MM992-4SFP for SFP plug-in transceivers with 1 x 100 or 1 x 1000 Mbps multi-mode or single-mode, glass 	<p>6GK5991-4AB00-8AA0</p> <p>6GK5991-4AC00-8AA0</p> <p>6GK5992-4AL00-8AA0</p> <p>6GK5992-4AM00-8AA0</p> <p>6GK5992-4AS00-8AA0</p>	<p>IE Connecting Cable IE FC RJ45 Plug-180/IE FC RJ45 Plug-180</p> <p>Preassembled IE FC TP Trailing Cable GP 2 x 2 (PROFINET type C) with two IE FC RJ45 Plug-180, IP20 degree of protection</p> <p>Length:</p> <ul style="list-style-type: none"> 1.0 m 5.0 m 10.0 m <p>6XV1871-5BH10</p> <p>6XV1871-5BH50</p> <p>6XV1871-5BN10</p>
<p><i>Accessories</i></p> <p>IE FC Stripping Tool</p> <p>Pre-adjusted stripping tool for fast stripping of Industrial Ethernet FC cables</p> <p>IE FC RJ45 Plug 180</p> <p>RJ45 plug-in connector for Industrial Ethernet with a rugged metal enclosure and integrated insulation/displacement contacts for connecting Industrial Ethernet FC installation cables; with 180° cable outlet; for network components and CPs/CPUs with Industrial Ethernet interface</p> <ul style="list-style-type: none"> 1 pack = 1 unit <p>IE FC TP Standard Cable GP 2 x 2 (Type A)</p> <p>4-core, shielded TP installation cable for connection to IE FC Outlet RJ45/IE FC RJ45 Plug; PROFINET-compatible; with UL approval; sold by the meter; max. length 1000 m, minimum order quantity 20 m</p> <p>IE FC RJ45 Plug 4 x 2</p> <p>IE FC RJ45 plug 180 4 x 2; RJ45 connector; Cat6A; (10/100/1000/10000 Mbps) with rugged metal enclosure; FC connection method; for IE FC cable 4 x 2 (AWG24); 180° cable outlet</p> <ul style="list-style-type: none"> 1 pack = 1 unit 	<p>6GK1901-1GA00</p> <p>6GK1901-1BB10-2AA0</p> <p>6XV1840-2AH10</p> <p>6GK1901-1BB12-2AA0</p>	<p>IE TP Cord RJ45/RJ45</p> <p>TP cable 4 x 2 with two RJ45 connectors</p> <ul style="list-style-type: none"> 1 m 6 m 10 m <p>6XV1870-3QH10</p> <p>6XV1870-3QH60</p> <p>6XV1870-3QN10</p> <p>FC FO Termination Kit</p> <p>Termination Kit for local assembly of FC SC and FC BFOC connectors to FC FO Standard Cable, comprising a stripping tool, Kevlar cutters, fiber breaking tool and microscope</p> <p>FC BFOC Plug</p> <p>Screw connector for on-site assembly on FC fiber-optic cable; (1 pack = 20 units + cleaning cloths)</p> <p>FC SC Plug</p> <p>Screw connector for on-site assembly on FC fiber-optic cable; (1 pack = 10 duplex plugs + cleaning cloths)</p> <p>FC FO Standard Cable GP 62.5/200/230</p> <p>FC FO Standard Cable for fixed routing indoors with PVC sheath; sold by the meter; max. length 1000 m; minimum order 20 m</p> <p>Multi-mode FO BFOC connector set</p> <p>For FO Standard Cable (50/125/1400), FO Ground Cable (50/125/1400), flexible FO Trailing Cable, INDOOR FC Cable (62.5/125/900), 20 units</p> <p>Multi-mode FO SC duplex connector set</p> <p>For FO Standard Cable (50/125/1400), FO Ground Cable (50/125/1400), flexible FO Trailing Cable, INDOOR FC Cable (62.5/125/900), 10 units</p> <p>6GK1900-1GL00-0AA0</p> <p>6GK1900-1GB00-0AC0</p> <p>6GK1900-1LB00-0AC0</p> <p>6XV1847-2A</p> <p>6GK1901-0DA20-0AA0</p> <p>6GK1901-0LB10-2AA0</p>

SIMATIC PCS 7 system hardware

Industrial communication

Industrial Ethernet

SCALANCE XR-500 switches > Media modules for modular SCALANCE XR-500

Ordering data	Article No.		Article No.
LC Plug MM²⁾	6GK1901-0RB10-2AB0		
FO Standard Cable GP 50/125/1400¹⁾²⁾ Multimode cable, sold by the meter; max. length 1000 m; minimum order 20 m	6XV1873-2A	MM FO Cord SC/SC With two SC duplex connectors, 1 m <u>Single-mode</u>	6XV1843-5EH10-0CC0
Pre-assembled FO patch cables <u>Multimode</u>		SM FO Cord SC/LC With one SC duplex connector and one LC duplex connector, 1 m	6XV1843-5FH10-0CA0
MM FO Cord SC/LC With one SC duplex connector and one LC duplex connector, 1 m	6XV1843-5EH10-0CA0	SM FO Cord SC/BFOC With one SC duplex connector and two BFOC connectors, 1 m	6XV1843-5FH10-0CB0
MM FO Cord SC/BFOC With one SC duplex connector and two BFOC connectors, 1 m	6XV1843-5EH10-0CB0	SM FO Cord SC/SC With two SC duplex connectors, 1 m	6XV1843-5FH10-0CC0

- 1) Special fiber-optic cables; lengths and accessories available on request
 2) Special tools and trained personnel are required for pre-assembling glass fiber-optic cables

Overview

- The 24 V DC power supply SCALANCE PS598 is designed for installation in 19" control cabinets or for direct mounting on SCALANCE XR-500 Industrial Ethernet switches. It features degree of protection IP20.
- 300 W output power at an input voltage range of 85 V AC to 264 V (50/60 Hz) and an operating temperature of 0 °C to +60 °C

Benefits

- Global application due to wide-range input (85 to 264 V AC)
- High reliability since short-circuit proof, secure against no-load operation, and able to bridge short breaks in the mains power

Design

- Non-heating apparatus socket for connecting to the AC network of 85 to 264 V AC (non-heating apparatus cable not included in the scope of delivery; can be ordered optionally on country-specific basis)
- Terminal block for universal supply of products with 24 V DC input
- Plug-in contact for direct connection on the rear of the SCALANCE XR-500 Industrial Ethernet switches (mounting kit included in scope of delivery of SCALANCE XR-500)
- Operating temperatures from 0°C to +60°C
- IP20 degree of protection
- Optimized for installation in 19" control cabinet or for direct mounting on SCALANCE XR-500 (SCALANCE XR-500 and power supply unit are mounted in the 19" control cabinet as a single unit)
- LEDs for indicating the status information (power, operating state)

Ordering data
Article No.
Power supplies for SCALANCE X-500

24 V power supplies are designed for installation in 19" control cabinets or for direct mounting on SCALANCE X-500 Industrial Ethernet switches; degree of protection IP20

SCALANCE PS598-1
6GK5598-1AA00-3AA0

300 W output power, input voltage range of 85 V to 264 V AC, operating temperature of 0 °C to +60 °C

Accessories
Appliance cable

- Grounded Continental European plug; region: D/F/NL/ESP/B/A/S/FIN
- Grounded British plug; region: UK
- Grounded Swiss plug; region: CH
- Grounded North American and Japanese plug; region: USA
- Grounded Italian plug; region: Italy
- Grounded Chinese plug; region: China

6ES7900-0AA00-0XA0
6ES7900-0BA00-0XA0
6ES7900-0CA00-0XA0
6ES7900-0DA00-0XA0
6ES7900-0EA00-0XA0
6ES7900-0FA00-0XA0

SIMATIC PCS 7 system hardware

Industrial communication

Industrial Ethernet

SCALANCE accessories

Overview

Accessories for Industrial Ethernet

- C-PLUG;
removable data storage medium that supports the fast and easy replacement of SIMATIC NET components without a programming device in the event of a fault.
- CLP;
removable data storage medium that supports the fast and easy replacement of components with a CLP slot (e.g. SCALANCE W1788) without a programming device in the event of a fault.
- PS791-1PRO power supply;
AC/DC power supply unit with IP65 degree of protection for the SCALANCE X208PRO and SCALANCE X204IRT PRO Industrial Ethernet switches.
- RUGGEDCOM RP100;
PoE (Power over Ethernet) power supply units for supplying power to remote PoE devices via a Cat 5 standard cable.

Overview

The replacement of network devices is easily possible and requires no special knowledge: The C-plug, Key-plug and SCALANCE CLP removable data storage media are used for backing up the configuration and engineering data of your SCALANCE devices or SIMATIC communications processors (CPs). Simply remove the PLUG from the defective unit, install the replacement device and reinsert the PLUG – the new device is now ready for operation and already has the same configuration as the previous one. The Key-plugs include all C-plug functions and additionally enable specific supplementary industrial functions, such as iFeatures, in SCALANCE devices.

Benefits

get Designed for Industry

C-plug:

- Fast and easy replacement of SIMATIC NET components without reconfiguration of the spare part.
- The device can be replaced without the need for specially trained personnel, programming device or PC.
- Downtimes of network segments and connected Industrial Ethernet nodes is minimized if a fault occurs.
- Automatic backup of configuration and project engineering data for SIMATIC NET components
- The C-plug can also be used to store application data such as documentation or web pages.

Key-plug:

- The Key-plugs include all C-plug functions.
- In addition, they enable specific supplementary industrial functions, such as iFeatures, in SCALANCE devices.

Application

C-plug:

The C-plug is used whenever the replacement of network components or communication modules needs to be quick and simple when a fault occurs, without having to configure the replacement and without the need for specialist personnel. It can be used in all SIMATIC NET products with a C-plug slot.

Key-plug:

The Key-plugs include all the C-plug functions and additionally enable supplementary industrial functions.

The SINEMA RC Key-plug is a removable data storage medium for enabling connection to SINEMA Remote Connect for S615 and SCALANCE M. It is also used for simple device replacement if a fault occurs, and for storing configuration data.

Design

C-plug:

The C-plug is offered in two designs:

- C-plug with IP20 degree of protection
- C-plug with IP20 degree of protection and with conformal coating for use in harsh environments.

Protection for IP65/67 components is ensured by the design of the target device. The power supply is also provided by the terminal device.

The C-plug is inserted in the designated slot of the SIMATIC NET component. The configuration data are automatically saved to the C-plug during device start-up and reconfiguring.

If a device needs to be replaced, the C-plug is simply removed from the failed component and plugged into the replacement device. The replacement device installed in the network or automation system now starts up automatically with the same device configuration as the failed device.

To prevent unintentional removal or falling out, the C-plug slot is usually located on the rear of the devices.

Key-plug:

The SINEMA RC Key-plug is offered in a version with degree of protection IP20. Protection for IP65/67 components is ensured by the design of the target device. The power supply is also provided by the terminal device.

The Key-plug is inserted in the plug compartment of the SCALANCE component.

To prevent unintentional removal or falling out, the plug slot is usually located on the rear of the devices.

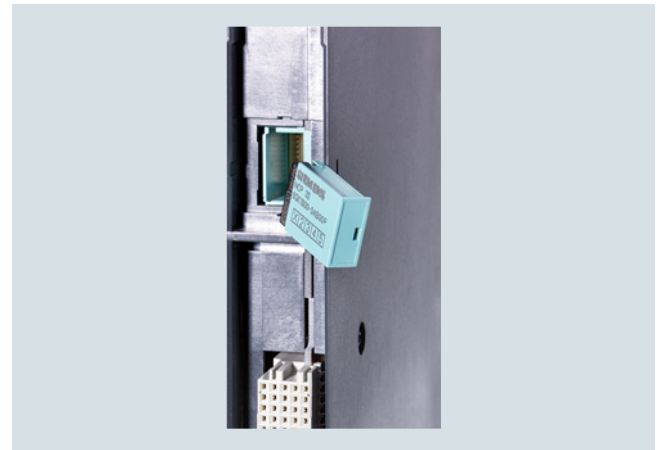

Plugging the C-plug into the rear of the CP 443-1 Advanced

SIMATIC PCS 7 system hardware

Industrial communication

Industrial Ethernet

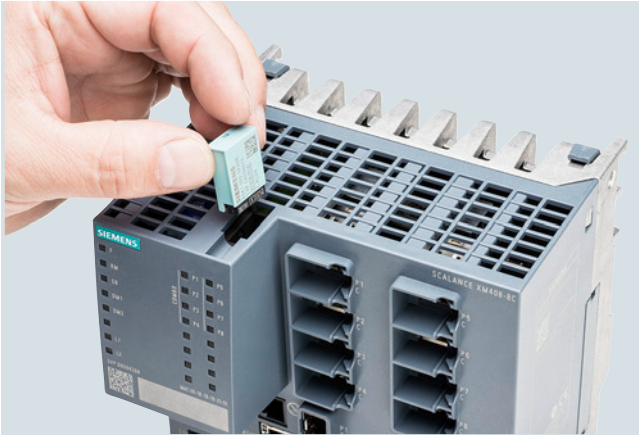
SCALANCE accessories > C-PLUG**Design** (continued)

Plugging the C-plug into the SCALANCE XM408-8C switch



Plugging the Key-pug into the plug slot of a SCALANCE network component (here: W788-1 M12)

FunctionC-plug:

During start-up, the device automatically backs up the configuration data on an unwritten C-plug (delivery state) that has been plugged into a SIMATIC NET component. Changes to the configuration during operation are also saved on the C-plug without any additional operator intervention being necessary.

During start-up, an unconfigured device automatically loads the configuration data from an inserted, written C-plug, provided the data were written by a compatible device type.

Diagnostics

Incorrect use of the C-plug, such as inserting a C-plug containing the configuration of a different device group, or general malfunctions of the C-plug are indicated by diagnostic mechanisms of the respective terminal device (LEDs, PROFINET, SNMP, Web-based Management, etc.).

The following devices of the named product lines have a C-plug slot:

Product line	C-PLUG 6GK1900-0AB00	C-PLUG 6GK1900-0AB10
SCALANCE X Industrial Ethernet switches	SCALANCE X-200 - - SCALANCE X-300 (included in scope of supply) SCALANCE X-400 (included in scope of supply) -	SCALANCE XC-200, SCALANCE XP-200 SCALANCE XF-200 BA SCALANCE XF-200BA DNA -
SCALANCE S security modules	SCALANCE S-600 -	SCALANCE XM-400 (included in scope of supply) SCALANCE XR-500 (included in scope of supply) SCALANCE S-615 SCALANCE SC600
Industrial Wireless LAN SCALANCE W	- - -	W78x, W77x IWLAN access points W74x, W73x IWLAN client modules
SCALANCE M industrial modems and routers	- - -	SCALANCE M81x SCALANCE M826 SCALANCE M87x
System connections for SIMATIC S7	CP 443-1 Advanced (included in scope of supply) CP 343-1 Advanced (included in scope of supply) CP 343-1 ERPC (included in scope of supply)	- - -
Gateways	IE/PB LINK PN IO IE/AS-i LINK PN IO DP/AS-i LINK Advanced	- - -

Note:

For all SIMATIC-NET components that are designed for more severe environmental conditions (e.g. SCALANCE XP-200EEC), the C-plug conformal coating (6GK1900-0AQ00) is also suitable.

Key-plug:

The Key-plugs include all the C-plug functions and additionally enable supplementary industrial functions.

The SINEMA RC Key-plug is a removable data storage medium for enabling connection to SINEMA Remote Connect for S615 and SCALANCE M. It is also used for simple device replacement if a fault occurs, and for storing configuration data.

Ordering data	Article No.		Article No.
<p>C-plug</p> <p>Removable data storage medium for easy replacement of devices in case of error. For storing configuration and application data. Can be used in the following SIMATIC NET products with plug slots:</p> <ul style="list-style-type: none"> SCALANCE X-200, X-300, X-400, S-600, CP443-1 Advanced, CP343-1 Advanced, CP343-1 ERPC, IE/PB Link PNIO, IE/AS-I Link PNIO, DP/AS-I LINK Advanced SCALANCE XC-200, XP-200, XM-400, XR-500, M-800, S615 and W-700 	<p>6GK1900-0AB00</p> <p>6GK1900-0AB10</p>	<p>Key-plug SINEMA RC</p> <p>Removable data storage medium enabling connection to SINEMA Remote Connect, for simple device replacement if a fault occurs, and for storing configuration data</p>	<p>6GK5908-0PB00</p>

Technical specifications

	C-plug 6GK1900-0AB00	6GK1900-0AB10	Key-plug 6GK5908-0PB00
Supply voltage	Via terminal device	Via terminal device	Via terminal device
Power loss	0.015 mW	0.015 mW	Via terminal device
Assembly	Can be plugged into C-plug slot	Can be plugged into C-plug slot	Can be plugged into Key-plug slot
Constructional design			
• Dimensions (W x H x D) in mm	24.3 x 17 x 8.1	24.3 x 17 x 8.1	24.3 x 17 x 8.1
• Weight	Approx. 5 g	Approx. 5 g	Approx. 5 g
Memory capacity	32 MB	256 MB	256 MB
Degree of protection	IP20	IP20	IP20

More information

Selection tool:

The TIA Selection Tool supports the selection of corresponding network components and software and is available at:

<http://www.siemens.com/tia-selection-tool>

SIMATIC PCS 7 system hardware

Industrial communication

Industrial Ethernet

SCALANCE accessories > Plug-in transceiver for SCALANCE

Overview

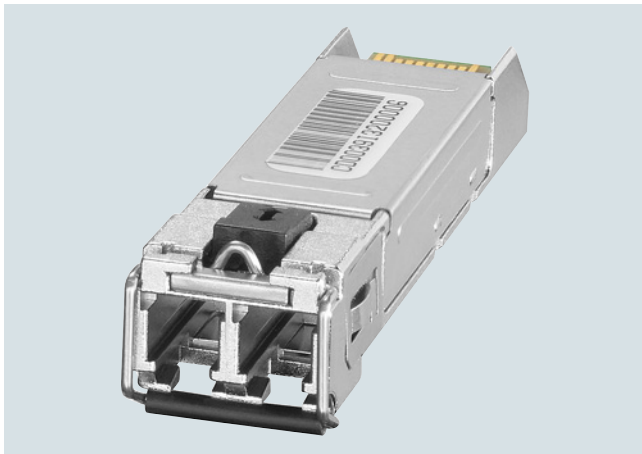

- Plug-in transceivers allow you to flexibly equip network components of the SCALANCE family with a corresponding SFP slot for optical connections SFP slots are available for the following devices:
 - SCALANCE XC-200
 - SCALANCE X-200RNA
 - SCALANCE X-300M, SCALANCE XR-300, SCALANCE XR-300WG
 - SCALANCE XM-400
 - SCALANCE XR-500
 - SCALANCE SC-600
 - SCALANCE W786-2SFP
- With an operating temperature range from -40 °C to +85 °C, the plug-in transceivers are especially suitable for use in demanding environments.
- All specified plug-in transceivers are tested for use with SCALANCE devices
- There are different versions that differ depending on suitable fiber types, range, and bandwidth

Product versions

SFP (small form-factor pluggable) transceivers can be directly plugged in (e.g. on the SCALANCE SC646-2C) or connectable via media modules (e.g. MM992-2SFP for modular X-300 Industrial Ethernet switches).

Optical SFP plug-in transceivers with 1 x 100 Mbps LC port

- SFP991-1 multimode, glass, up to 5 km: variants with and without coated printed circuit boards (conformal coating)
- SFP991-1A multimode, glass, up to 5 km
- SFP991-1LD, single-mode, glass, up to 26 km: variants with and without coated printed circuit boards (conformal coating)
- SFP991-1LD A single-mode, glass, up to 26 km
- SFP991-1LH+, single-mode, glass, up to 70 km
- SFP991-1ELH200 single-mode, glass, up to 200 km

Optical SFP plug-in transceivers with 1 x 1 000 Mbps LC port

- SFP992-1 multimode, glass, up to 750 m: variants with and without coated printed circuit boards (conformal coating)
- SFP992-1+ multimode, glass, up to 2 km
- SFP992-1BXM multimode, glass, up to 500 m, bidirectional
- SFP992-1BXT multimode, glass, up to 500 m, bidirectional
- SFP992-1LD, single-mode, glass, up to 10 km: variants with and without coated printed circuit boards (conformal coating)
- SFP992-1BX10R, single-mode, glass, up to 10 km, bidirectional
- SFP992-1BX10T, single-mode, glass, up to 10 km, bidirectional
- SFP992-1LD+, single-mode, glass, up to 30 km
- SFP992-1LH, single-mode, glass, up to 40 km
- SFP992-1LH+, single-mode, glass, up to 70 km
- SFP992-1ELH single-mode, glass, up to 120 km

Optical SFP plug-in transceivers with 1 x 10 000 Mbps LC port

- SFP993-1 multimode, glass, up to 300 m
- SFP993-1LD, single-mode, glass, up to 10 km
- SFP993-1LH, single-mode, glass, up to 40 km

Benefits

get Designed for Industry

- Modular system permits cost savings. The modular system facilitates easy setup of electrical and optical Industrial Ethernet networks as well as modification of the network topology and port type to suit the plant structure, with expansion possible at any time
- Easy integration of SCALANCE products with pure 1 000 Mbps SFP interfaces (such as SCALANCE XC216-4C G) into existing 100 Mbps networks by using active SFPs, SFP991-1A and SFP991-1LD A
- Integrated industrial network for data, speech, and video; high performance due to Gigabit ports
- Bandwidths from 100 Mbps to 10 Gbps

Design

- Operating temperature range of the SFP plug-in transceivers from -40 °C to +85 °C
- SFP plug-in transceivers have an LC connection
- Degree of protection IP20

Electrically preassembled SFP+/SFP+ connecting cable with 10 Gbit/s

The IE Connecting Cable SFP+/SFP+ is preassembled at both ends and suitable for the transmission of 10 Gbit/s Ethernet. The cables have SFP+ connectors for use in the SFP+ slots of the SCALANCE X-500 series and therefore offer the possibility of connecting SCALANCE X-500 switches cost-effectively over short distances with a bandwidth of 10 Gbit/s. The SFP+/SFP+ connecting cables can only be used in the integrated SFP+ slots of the SCALANCE X-500.

- IE connecting cable SFP+/SFP+ 1 m;
Twinax copper cable with a length of 1 m
- IE connecting cable SFP+/SFP+ 2 m;
Twinax copper cable with a length of 2 m
- IE connecting cable SFP+/SFP+ 7 m;
Twinax copper cable with a length of 7 m

	10 Gigabit Ethernet		Gigabit Ethernet			Fast Ethernet		Max. distance
	10 Gbit/s		10/100/1000 Mbit/s	1000 Mbit/s		100 Mbit/s		
	Optical		Electrical	Optical		Optical		
	Multimode	Singlemode	Twisted Pair	Multimode	Singlemode	Multimode	Singlemode	
	SFP991-1 ²⁾					1x LC		5 km
	SFP991-1 ^{1) 2)}					1x LC		5 km
	SFP991-1A ²⁾					1x LC		5 km
	SFP991-1LD ²⁾						1x LC	26 km
	SFP991-1LD ^{1) 2)}						1x LC	26 km
	SFP991-1LD A ²⁾						1x LC	26 km
	SFP991-1LH ²⁾						1x LC	70 km
	SFP991-1ELH200 ²⁾						1x LC	200 km
	SFP992-1 ³⁾				1x LC			750 m
	SFP992-1 ^{1) 3)}				1x LC			750 m
	SFP992-1+ ³⁾				1x LC			2 km
	SFP992-1LD ³⁾					1x LC		10 km
	SFP992-1LD ^{1) 3)}					1x LC		10 km
	SFP992-1LD+ ³⁾					1x LC		30 km
	SFP992-1BXT ⁵⁾				1x LC			500 m
	SFP992-1BXT ⁵⁾				1x LC			500 m
	SFP992-1BX10T ⁵⁾					1x LC		10 km
	SFP992-1BX10R ⁵⁾					1x LC		10 km
	SFP992-1LH ³⁾					1x LC		40 km
	SFP992-1LH+ ³⁾					1x LC		70 km
	SFP992-1ELH ³⁾					1x LC		120 km
	SFP+-Module ⁴⁾							
	SFP993-1	1x LC						300 m
	SFP993-1LD		1x LC					10 km
	SFP993-1LH		1x LC					40 km
	IE Cable SFP+/SFP+	2x LC						⁶⁾

1) Coated PCBs (conformal coating)
 2) Can only be inserted in SFP slot
 3) Can only be inserted in SFP/SFP+ slot

4) Can only be inserted in SFP+ slot
 5) Bidirectional
 6) Lengths available in 1 m, 2 m, 7 m

SFP plug-in transceiver for SCALANCE XC-200, X-300, XM-400, XR-500, SC-600 and W786-2SFP

SIMATIC PCS 7 system hardware

Industrial communication

Industrial Ethernet

SCALANCE accessories > Plug-in transceiver for SCALANCE

Design (continued)

		SCALANCE									
		X-C-200	X-200RNA	SFP media module X-300	XR-300WG	XM-400 / PE-400	XR-500 / SFP media module XR-500	10GB-Slots XR-500	SC-600	W786-2SFP	
SFP type											
	SFP991-1 ²⁾	• ⁶⁾	•	•		•	•		•		
	SFP991-1 ^{1) 2)}	• ⁶⁾	•	•		•	•		•		
	SFP991-1A ²⁾	• ⁷⁾			•						
	SFP991-1LD ²⁾	• ⁶⁾	•	•		•	•		•		
	SFP991-1LD ^{1) 2)}	• ⁶⁾	•	•		•	•		•		
	SFP991-1LD A ²⁾	• ⁷⁾			•						
	SFP991-1LH ²⁾	• ⁶⁾	•	•		•	•		•		
	SFP991-1ELH200 ²⁾	• ⁶⁾	•	•		•	•		•		
	SFP992-1 ³⁾	•		•	•	•	•	•	•	•	
	SFP992-1 ^{1) 3)}	•		•	•	•	•	•	•	•	
	SFP992-1 ⁺ 3)	•		•	•	•	•	•	•	•	
	SFP992-1LD ³⁾	•		•	•	•	•	•	•	•	
	SFP992-1LD ^{1) 3)}	•		•	•	•	•	•	•	•	
	SFP992-1LD+	•		•	•	•	•	•	•	•	
	SFP992-1BXMT ⁵⁾	•		•	•	•	•	•	•	•	
	SFP992-1BXMR ⁵⁾	•		•	•	•	•	•	•	•	
	SFP992-1BX10T ⁵⁾	•		•	•	•	•	•	•	•	
	SFP992-1BX10R ⁵⁾	•		•	•	•	•	•	•	•	
	SFP992-1LH ³⁾	•		•	•	•	•	•	•	•	
	SFP992-1LH ⁺ 3)	•		•	•	•	•	•	•	•	
	SFP992-1ELH ³⁾	•		•	•	•	•	•	•	•	
	SFP+-Module ⁴⁾										
	SFP993-1							•			
SFP993-1LD							•				
SFP993-1LH							•				
IE Cable SFP+/SFP+							•				

• applies

1) Coated PCBs (conformal coating)
 2) Can only be inserted in SFP slot
 3) Can only be inserted in SFP/SFP+ slot
 4) Can only be inserted in SFP+ slot
 5) Bidirectional
 6) XC206-2SFP only
 7) XC-200G only

G_IK10_XX_10444

Overview of supported SFP plug-in transceivers for SCALANCE network components

Ordering data	Article No.	Article No.
<i>SFP plug-in transceivers together with the MM992-2SFP media module in the modular SCALANCE X-300 Industrial Ethernet switches</i>		
With 1 × 100 Mbps LC port, optical <ul style="list-style-type: none"> SFP991-1 multimode, glass, up to 5 km SFP991-1 multimode, glass, up to max. 5 km, conformal coating SFP991-1A multimode, glass, up to 5 km SFP991-1LD single-mode, glass, up to 26 km SFP991-1LD single-mode, glass, up to max. 26 km, conformal coating SFP991-1LD A single-mode, glass, up to 26 km SFP991-1LH+ single-mode, glass, up to 70 km SFP991-1ELH200 single-mode, glass, up to max. 200 km 	6GK5991-1AD00-8AA0 6GK5991-1AD00-8FA0 6GK5991-1AD00-8GA0 6GK5991-1AF00-8AA0 6GK5991-1AF00-8FA0 6GK5991-1AF00-8GA0 6GK5991-1AE00-8AA0 6GK5991-1AE30-8AA0	IE connecting cable SFP+/SFP+, electrical, 10 Gbps Twinax copper cables, length <ul style="list-style-type: none"> • 1 m • 2 m • 7 m
With 10 × 1 × 100 Mbps LC port, optical <ul style="list-style-type: none"> SFP991-1 multimode, glass, up to 5 km SFP991-1LD single-mode, glass, up to 26 km 	6GK5991-1AD00-8AC0 6GK5991-1AF00-8AC0	Accessories LC Plug MM ²⁾ 6GK1901-0RB10-2AB0 FO Standard Cable GP 50/125/1400 ^{1) 2)} 6XV1873-2A Multimode cable, sold by the meter; max. delivery unit 1 000 m; minimum order quantity 20 m Pre-assembled FO Patch Cables Multimode MM FO Cord SC/LC 6XV1843-5EH10-0CA0 With one SC duplex plug and one LC duplex plug, 1 m SM FO Cord SC/LC 6XV1843-5FH10-0CA0 With one SC duplex plug and one LC duplex plug, 1 m
With 1 × 1 000 Mbps LC port, optical <ul style="list-style-type: none"> SFP992-1 multimode, glass, up to max. 750 m SFP992-1 multimode, glass, up to max. 750 m, conformal coating SFP992-1BXMR, multimode, glass, up to max. 500 m, bidirectional SFP992-1BXMT, multimode, glass, up to max. 500 m, bidirectional SFP992-1+ multimode, glass, up to max. 2 km SFP992-1LD single-mode, glass, up to 10 km SFP992-1LD single-mode, glass, up to 10 km, conformal coating SFP992-1BX10R, single-mode, glass, up to max. 10 km, bidirectional SFP992-1BX10T, single-mode, glass, up to max. 10 km, bidirectional SFP992-1LD+, single-mode, glass, up to max. 30 km SFP992-1LH single-mode, glass, up to 40 km SFP992-1LH+ single-mode, glass, up to 70 km SFP992-1ELH single-mode, glass, up to max. 120 km 	6GK5992-1AL00-8AA0 6GK5992-1AL00-8FA0 6GK5992-1AL00-8RA0 6GK5992-1AL00-8TA0 6GK5992-1AG00-8AA0 6GK5992-1AM00-8AA0 6GK5992-1AM00-8FA0 6GK5992-1AM00-8RA0 6GK5992-1AM00-8TA0 6GK5992-1AM30-8AA0 6GK5992-1AN00-8AA0 6GK5992-1AP00-8AA0 6GK5992-1AQ00-8AA0	¹⁾ Special fiber-optic cables, lengths and accessories available on request ²⁾ Special tools and trained personnel are required for pre-assembling glass fiber-optic cables
With 10 × 1 × 1 000 Mbps LC port, optical <ul style="list-style-type: none"> SFP992-1 multimode, glass, up to max. 750 m SFP992-1LD single-mode, glass, up to 10 km 	6GK5992-1AL00-8AC0 6GK5992-1AM00-8AC0	
With 1 × 10 000 Mbps LC port, optical <ul style="list-style-type: none"> SFP993-1 multimode, glass, up to max. 300 m SFP993-1LD single-mode, glass, up to 10 km SFP993-1LH single-mode, glass, up to 40 km 	6GK5993-1AT00-8AA0 6GK5993-1AU00-8AA0 6GK5993-1AV00-8AA0	

SIMATIC PCS 7 system hardware

Industrial communication

Industrial Ethernet

Passive network components > FastConnect

Overview



Industrial Ethernet FastConnect RJ45 plugs

Industrial Ethernet FastConnect (IE FC) is a rapid assembly system with insulation displacement for easy assembly and wiring of 4-wire and 8-wire IE FC cables. Using the FC stripping tool, it is possible to remove the outer casing and woven shield of the IE FC cable accurately in a single step. The cable prepared in this manner is subsequently assembled on the cut/crimp contacts of the connection element.

Application

Linking elements

The linking elements which can be used depend on whether the transmission rate is 10/100 Mbps or 1 000 Mbps:

- IE FC RJ45 plug 2x2 90/180 (10/100 Mbps) in association with 4-wire (2x2) IE FC cables
- IE FC RJ45 plug 4x2 180 (10/100/1 000 Mbps) in association with 8-wire (4x2) IE FC cables
- IE FC outlet RJ45 (10/100 Mbps) in association with 4-wire (2x2) IE FC cables
- IE FC RJ45 modular outlet (10/100/1 000 Mbps) with 8-wire (4x2) IE FC cables

The following table provides an overview of the electric port types of the switches, the transmission rates they support, and the IE FC TP standard cables and IE FC connecting elements which can be used. In addition to the IE FC TP standard cables, Catalog IK PI offers further IE FC TP cables with special properties.

Transmission rate	10/100 Mbps		1 000 Mbps	
Port type	10/100BaseTX		1000BaseTX	
Max. cable length	100 m	90 m (+ total of 10 m for TP cord patch cables)	90 m	90 m (+ total of 10 m for TP cord patch cables)
Cable type	IE FC TP standard cable 2x2	IE FC TP standard cable 4x2	IE FC TP standard cable 4x2 (AWG 24)	IE FC TP standard cable 4x2 (AWG 22)
Connecting elements	IE FC RJ45 plug 2x2 90/180, alternatively: IE FC outlet RJ45 + TP cord patch cable	IE FC RJ45 modular outlet with insert 2FE + TP cord patch cable	IE FC RJ45 plug 4x2 180	IE FC RJ45 modular outlet with insert 1GE + TP cord patch cable

Application (continued)

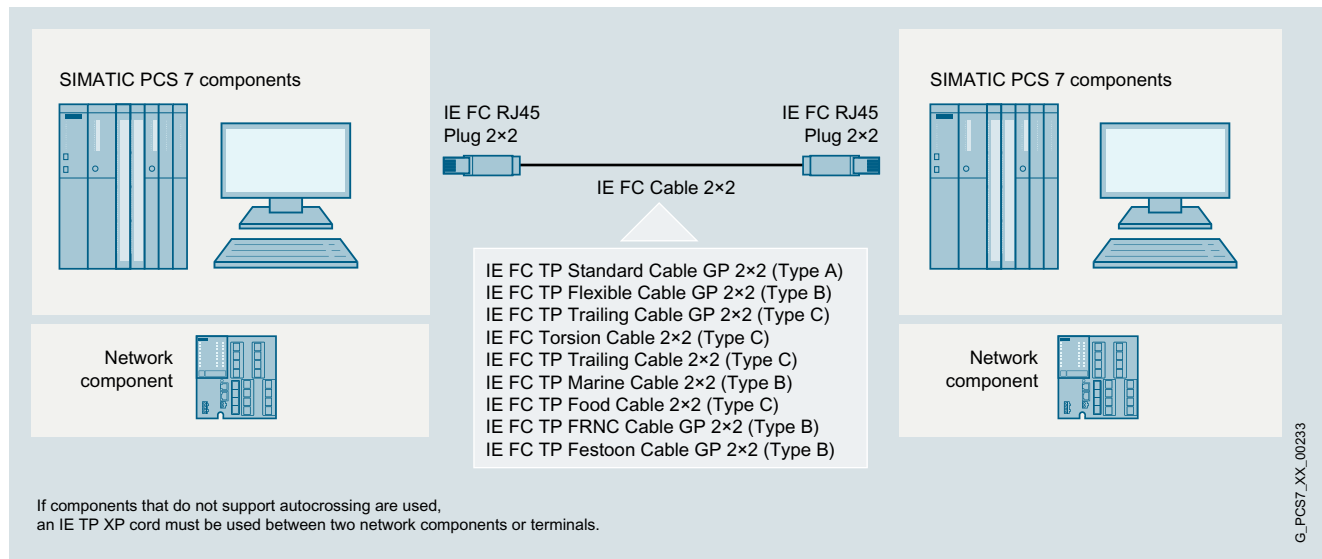

Use of FastConnect cables 2x2 with IE FC RJ45 plug 2x2

IE FC RJ45 plug 2x2

The IE FC RJ45 plugs 2x2 suitable for simple and fast on-site assembly of 4-wire (2x2) twisted pair (TP) FastConnect installation cables are the ideal solution for Industrial Ethernet communication connections for transmission rates up to 100 Mbps. They can be used to implement point-to-point connections without patch technology between two terminal

devices/network components over distances of up to 100 m. Since the IE FC RJ45 plugs 2x2 have no parts which can be lost, assembly is also possible under difficult conditions. For alternatives to the IE FC TP standard cable according to the configuration graphics, see Catalog IK PI, section "Industrial Ethernet", subsection "Cabling systems".

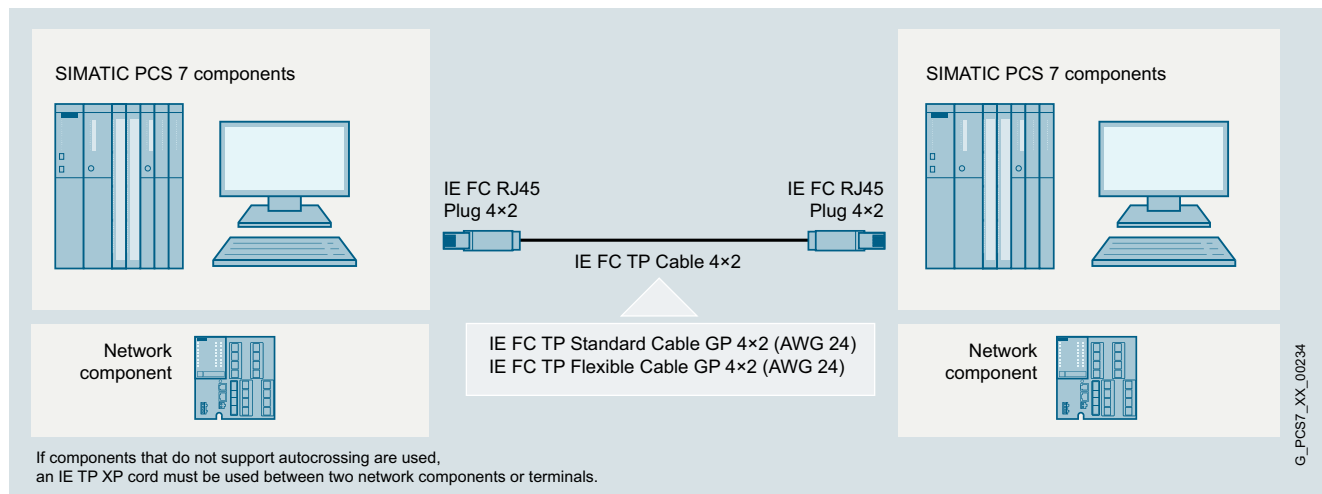

Use of FastConnect cables 4x2 with IE FC RJ45 plug 4x2

IE FC RJ45 plug 4x2

The compact, rugged design of the Cat6A plug connector enables the FC RJ45 plug to be used in both industrial and office environments.

The Industrial Ethernet FastConnect RJ45 plug 4x2 permits quick and easy installation of the Industrial Ethernet FastConnect installation cables 4x2 (8-wire twisted pair AWG24 cables) in the field.

The Industrial Ethernet FastConnect stripping tool for preparing the end of a cable (stripping the jacket and shield in one step) allows simple handling and swift, secure fitting of the connector to the cable. Since all connector parts are captive, it can also be fitted in difficult conditions.

The new plug connector allows the implementation of point-to-point connections (10/100/1 000 Mbps) for Industrial Ethernet between two terminal devices/network components up to 100 m apart without the need for patches (for details, see IK PI capital, "Industrial Ethernet", "Cabling systems").

SIMATIC PCS 7 system hardware

Industrial communication

Industrial Ethernet

Passive network components > FastConnect

Application (continued)

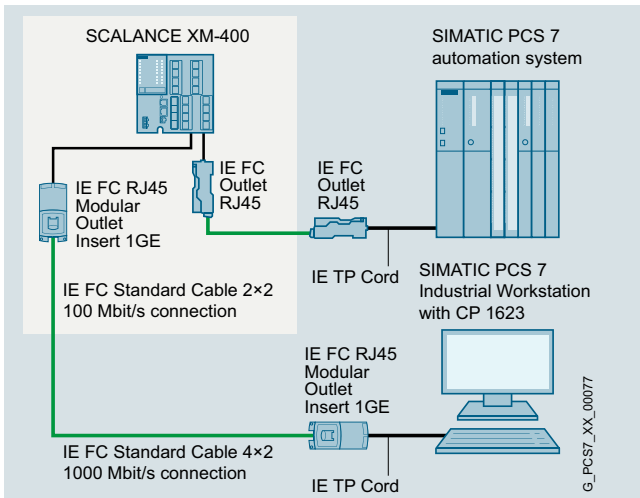

Configuration example with IE FC RJ45 modular outlet and IE FC outlet RJ45

IE FC outlet RJ45 and IE FC RJ45 modular outlet

Alternatives for conversion from RJ45 to the insulation displacement system:

- IE FC outlet RJ45 for 4-wire TP (2×2) IE FC cables and transmission rates up to 100 Mbps
- IE FC RJ45 modular outlet for 8-core TP (4×2) IE FC cables and transmission rates up to 1 000 Mbps.

The latter has the advantage that the existing wiring can still be used if communication is converted from 100 Mbps to 1 000 Mbps. It is only necessary to replace the 2FE insert by one of type 1GE. In contrast to the plugs, an RJ45 patch cable (TP cord) is also required for each outlet so that it can be connected to the network component or terminal device.

Detailed information on the FastConnect outlets and the available TP cords can be found in Catalog IK PI, in the Industry Mall or in CA 01 under "Industrial Communication".

Additional information on network structures is provided in the manual for TP and fiber-optic networks.

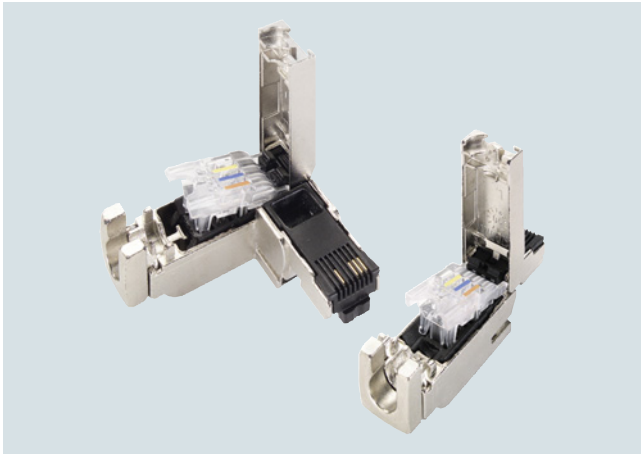
Design**IE FC RJ45 plugs 4x2 and 2x2**

IE FC RJ45 plug 2x2 with 90° outgoing cable (left) and with 180° outgoing cable (right)

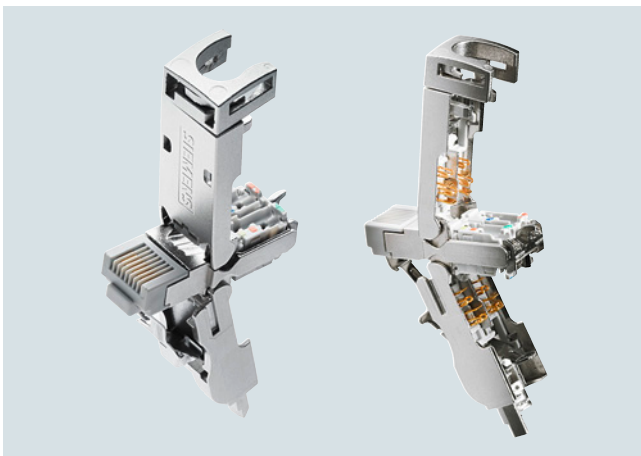

IE FC RJ45 plug 4x2 with 180° outgoing cable

In contrast to the IE FC RJ45 plug 4x2 which is only offered with a 180° (straight) outgoing cable, the IE FC RJ45 plug 2x2 is also available with a 90° (angled) outgoing cable.

All IE FC RJ45 plugs have a rugged, industry-compatible metal enclosure with integral strain relief that provides optimum protection for data communication against EMC interference. The integral insulation displacement contacts permit simple, fault-free contacting of the various types of FC cable. Following introduction of the stripped ends of the cables into the tipped-up barrel contacts, the latter are pressed down for secure contacting of the conductors.

With the housing open, colored marks on the contact cover identify correct connection of the cable cores. The transparent plastic material of the contact element allows visual inspection of the contacts.

Owing to their compact size, IE FC RJ45 plugs can be used both on devices with individual jacks and on devices with multiple jacks (blocks).

Matching retaining collars on terminal equipment, e.g. on devices from the SCALANCE X and SCALANCE S families, permits additional protection of the plug connection against tension and bending stresses.

IE FC RJ45 modular outlet

IE FC RJ modular outlet with insert 1GE

The IE FC RJ45 Modular Outlet (Base Module) designed for transmission rates up to 1 000 Mbps consists of a rugged metal housing with IP40 degree of protection which is suitable for both DIN mounting rail and wall mounting. It has 8 barrel contacts for connecting 8-core Industrial Ethernet FC installation cables (AWG 22) and an interface for the replaceable insert, for example:

- IE FC RJ45 modular outlet insert 2FE with 2 × RJ45 sockets for 100 Mbps
- IE FC RJ45 modular outlet insert 1GE with 1 × RJ45 socket for 1 000 Mbps
- IE FC RJ45 modular outlet power insert with 1 × RJ45 socket for 100 Mbps and 1 × 24 V DC connection (for details on use and ordering, see Section "Industrial Wireless LAN")

SIMATIC PCS 7 system hardware

Industrial communication

Industrial Ethernet

Passive network components > FastConnect

Ordering data

Article No.

Article No.

Industrial Ethernet**FC Standard Cable GP 2x2**

For universal use, for connection to IE FC Outlet RJ45 or IE FC RJ45, 4-core (2x2), shielded

- Sold by the meter; max. length 1 000 m; minimum order quantity 20 m
- Preferred length 1 000 m

6XV1840-2AH10

6XV1840-2AU10

Industrial Ethernet**FC Standard Cable GP 4x2**

8-core, shielded TP installation cable for universal applications; with UL approval

Sold by the meter; max. length 1 000 m, minimum order quantity 20 m

- AWG 22
For connection to IE FC RJ45 modular outlet
- AWG 24
For connection to IE FC RJ45 plug 4x2

6XV1870-2E

6XV1878-2A

Industrial Ethernet FC TP Robust Standard Cable GP 2x2 (PROFINET Type A)

TPE outer sheath, fixed installation, for connection to IE FC RJ45 or IE FC outlet RJ45, for universal use, 4-core, shielded, Cat. 5e

Sold by the meter, max. length 2 000 m; minimum order quantity 20 m

6XV1841-2A

Industrial Ethernet FC TP Robust Standard Cable GP 2x2 (PROFINET Type B)

TPE outer sheath, fixed installation, for connection to IE FC RJ45 or IE FC Outlet RJ45, for universal use, 4-core, shielded, Cat. 5e

Sold by the meter, max. length 2 000 m; minimum order quantity 20 m

6XV1841-2B

Industrial Ethernet**FC Stripping Tool**

Pre-adjusted stripping tool for fast stripping of Industrial Ethernet FC cables

6GK1901-1GA00

Industrial Ethernet FC Blade Cassettes

Replacement blade cassette for the Industrial Ethernet stripping tool, 5 units; for use with IE FC RJ45 Plugs and Modular Outlet

6GK1901-1GB00

IE FC RJ45 plug 2x2 180

RJ45 plug connector for Industrial Ethernet with a rugged metal enclosure and integrated insulation displacement contacts for connecting Industrial Ethernet FC installation cables; with 180° cable outlet; for network components and CPs/CPUs with Industrial Ethernet port

- 1 pack = 1 unit
- 1 pack = 10 units
- 1 pack = 50 units

6GK1901-1BB10-2AA0

6GK1901-1BB10-2AB0

6GK1901-1BB10-2AE0

Industrial Ethernet FC RJ45 Plug 2x2 90

RJ45 plug connector for Industrial Ethernet with a rugged metal housing and integrated insulation displacement contacts for connecting Industrial Ethernet FC installation cables; with 90° cable outlet

- 1 pack = 1 unit
- 1 pack = 10 units
- 1 pack = 50 units

6GK1901-1BB20-2AA0

6GK1901-1BB20-2AB0

6GK1901-1BB20-2AE0

Industrial Ethernet FC RJ45 Plug 4x2 180

Industrial Ethernet FastConnect RJ45 plug 180 4x2, RJ45 connector; CAT6A; (10/100/1 000/10 000 Mbps) with rugged metal enclosure and FC connection technology, for IE FC cable 4x2 (AWG24); 180° cable outlet

- 1 pack = 1 unit
- 1 pack = 10 units
- 1 pack = 50 units

6GK1901-1BB12-2AA0

6GK1901-1BB12-2AB0

6GK1901-1BB12-2AE0

Industrial Ethernet FC Outlet RJ45

6GK1901-1FC00-0AA0

IE FC RJ45 modular outlet with insert 1GE

FastConnect RJ45 Outlet for Industrial Ethernet with a replaceable insert for 1 x 1 000 Mbps interface

6GK1901-1BE00-0AA2

IE FC RJ45 modular outlet with insert 2FE

FastConnect RJ45 Outlet for Industrial Ethernet with a replaceable insert for 2 x 100 Mbps interface

6GK1901-1BE00-0AA1

For further IE FC RJ45 Modular Outlet versions and replaceable inserts, see Catalog IK PI

Overview

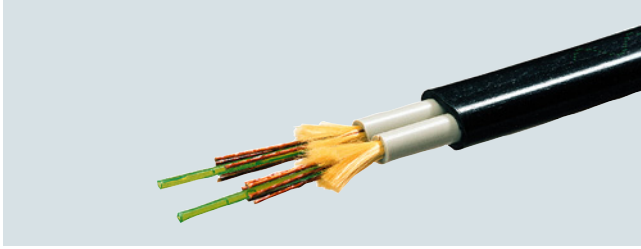

Optical transmission media

Glass fiber-optic cables are the preferred optical transmission medium. The two types of cable offered are suitable for above-ground routing indoors or outdoors. They are available in fixed lengths, pre-assembled with 2x2 BFOC connectors, 2x2 SC connectors or 2x2 LC connectors

The FO standard cable with 2 x 2 SC connectors is required for optical networking in the Gigabit range.

Note:

You can order supplementary components for the SIMATIC NET cabling range from your local contact. For technical advice contact:

Siemens AG
 SPG Industrial Network and Components, Fürth, Germany
 J. Hertlein
 Tel.: +49 911 750-4465
 E-mail: juergen.hertlein@siemens.com

Specifications, other cable lengths and other fiber-optic cables can be found in catalog IK PI.

More information on assembly is provided in the manual for TP and fiber-optic networks.

Selection tools

To assist in selecting the right Industrial Ethernet switches and with the configuration of modular variants, the SIMATIC NET Selection Tool and the TIA Selection Tool Cloud are available at:

<http://www.siemens.com/snst-standalone>

<http://www.siemens.com/tstcloud>

Ordering data

Article No.

FO standard cable

50/125¹⁾

Preferred lengths, pre-assembled with 2x2 SC connectors:

- 1 m
- 3 m
- 5 m
- 10 m
- 20 m
- 50 m
- 100 m
- 200 m
- 300 m

6XV1873-6AH10
 6XV1873-6AH30
 6XV1873-6AH50
 6XV1873-6AN10
 6XV1873-6AN20
 6XV1873-6AN50
 6XV1873-6AT10
 6XV1873-6AT20
 6XV1873-6AT30

FO standard cable

50/125¹⁾

Preferred lengths, pre-assembled with 2 LC duplex connectors:

- 1 m
- 2 m
- 3 m
- 5 m
- 10 m
- 15 m
- 20 m
- 30 m
- 40 m
- 50 m
- 80 m
- 100 m
- 150 m
- 200 m
- 300 m

6XV1873-5AH10
 6XV1873-5AH20
 6XV1873-5AH30
 6XV1873-5AH50
 6XV1873-5AN10
 6XV1873-5AN15
 6XV1873-5AN20
 6XV1873-5AN30
 6XV1873-5AN40
 6XV1873-5AN50
 6XV1873-5AN80
 6XV1873-5AT10
 6XV1873-5AT15
 6XV1873-5AT20
 6XV1873-5AT30

FIBER OPTIC CABLE

standard cable

62.5/125, may be split¹⁾

Preferred lengths, pre-assembled with 2x2 BFOC (ST) connectors:

- 1 m
- 3 m
- 5 m
- 10 m
- 20 m
- 50 m
- 100 m
- 200 m
- 300 m

6XV1820-5BH10
 6XV1820-5BH30
 6XV1820-5BH50
 6XV1820-5BN10
 6XV1820-5BN20
 6XV1820-5BN50
 6XV1820-5BT10
 6XV1820-5BT20
 6XV1820-5BT30

BFOC (ST) connector set

For FIBER OPTIC CABLE standard cable, 20 units

6GK1901-0DA20-0AA0

¹⁾ Special tools and specially trained personnel are required for pre-assembling glass fiber-optic cables.

SIMATIC PCS 7 system hardware





Industrial communication

Industrial Ethernet

Passive network components > Fiber-optic cables

More information

Various versions of the optical connections for fiber-optic cables are available with the network components or terminal equipment:

Design of optical connection	Description	
ST/BFOC connection = ST (stick and twist)	ST/BFOC connectors have a bayonet lock for glass fiber-optic cables. They are suitable for monomode and multimode fibers.	
SC connection	SC connectors are standard connectors for glass fiber-optic cables. The SC connector is usually in the duplex version. However, it can also be used as a simplex connector by separating it from the isolating piece.	
LC connection	FC FO LC PLUG for on site assembly on FC fiber-optic cables (62.5/200/230) (Duplex plugs + cleaning cloths)	
SC-RJ connection	SCRJ is the smallest SC duplex plug connection.	

For more information and an overview of the connectors for connection of fiber-optic cables to the optical interface of network components and terminal equipment see the Industry Online Support:

<https://support.industry.siemens.com/cs/ww/en/view/35146578>

under

<https://www.siemens.com/fastconnect>

Design

Connection of single stations, servers and clients

SIMATIC PCS 7 subsystems for engineering, operation and monitoring (also via Internet/Intranet), Batch Control, Route Control, Asset Management or IT applications are distributed between various SIMATIC PCS 7 Industrial Workstations of single station, server or client design depending on the configuration. Depending on their task and the associated integration into the overall plant, these SIMATIC PCS 7 Industrial Workstations are connected either on the plant bus only, the terminal bus only or on both buses of the Industrial Ethernet network. The connection can be redundant or non-redundant, and is made using:

- Interfaces integrated onboard
- Simple network adapters
- Special communication modules, e.g. CP 1623

Connection to plant bus

A SIMATIC PCS 7 workstation, designed as single station or server, can be operated on the Industrial Ethernet plant bus with a Ethernet network adapter (10/100/1000 Mbps) and BCE license or with a CP 1623 communication module and SIMATIC NET HARDNET-IE S7 or SIMATIC NET HARDNET-IE S7-REDCONNECT communications software.

The IE versions of the SIMATIC PCS 7 Industrial Workstation for single stations and servers are factory equipped with a CP 1623 communication module and SIMATIC NET HARDNET-IE S7 communication software, licensed for up to four CP 1623 (4x license).

CP 1623 has a PCI Express port x1 as well as a 2-port switch (RJ45) for connecting to Industrial Ethernet (10/100/1000 Mbps).

An Ethernet card (10/100/1 000 Mbps) with a BCE license is integrated in the BCE versions of the SIMATIC PCS 7 Industrial Workstation. A separately available desktop adapter network adapter can also be used with this BCE license in a SIMATIC PCS 7 Industrial Workstation.

If you use alternative hardware instead of the SIMATIC PCS 7 Industrial Workstation, you require an additional BCE license for each station which communicates over the plant bus via BCE (Basic Communication Ethernet).

With BCE, AS communication is possible with up to 8 automation systems, with SIMATIC NET HARDNET-IE S7 communication via CP 1623 with up to 64 automation systems (only AS single stations in each case, no AS redundancy stations).

Only the SIMATIC PCS 7 workstation with CP 1623 can communicate with redundant automation systems (redundancy stations). You require for this purpose SIMATIC NET HARDNET-IE S7-REDCONNECT (4x license) communications software instead of the SIMATIC NET HARDNET-IE S7 communications software. SIMATIC NET HARDNET-IE S7-REDCONNECT PowerPack (4x license) can be used to upgrade the communications software.

Single stations and servers with BCE can be retro-upgraded to CP 1623/1628 communication. Depending on the criteria mentioned above, this requires SIMATIC NET HARDNET-IE S7 or SIMATIC NET HARDNET-IE S7-REDCONNECT in addition to the CP 1623 communication module.

The communications software for CP 1623 is always supplied with the SIMATIC PCS 7 software and is installed in line with the operating system.

In order to activate this communications software, you may need additional licenses for the SIMATIC NET HARDNET-IE S7, SIMATIC NET HARDNET-IE S7-REDCONNECT, or SIMATIC NET HARDNET-IE S7-REDCONNECT PowerPack communication products.

Connection to terminal bus

SIMATIC PCS 7 Industrial Workstations in client, server or single station configurations are usually connected to the terminal bus via the onboard Industrial Ethernet interfaces. In the case of servers or single stations without a connection to the plant bus, the network adapter envisaged for BCE can be used as an alternative.

The terminal bus can also be configured redundantly. A configuration with two separate rings is recommended for the redundant, fault-tolerant terminal bus. The communication is performed in this case using the Parallel Redundancy Protocol (PRP) in accordance with IEC 62439-3. Each PCS 7 station should be connected to one of two Industrial Ethernet interfaces on each of the two separate rings. Industrial Ethernet interfaces are standard in all current SIMATIC PCS 7 Industrial Workstations.

The SIMATIC NET SOFTNET-IE RNA communications software on the redundant connection PCS 7 stations organizes communication processes based on the PRP. Therefore, SIMATIC NET SOFTNET-IE RNA communications software is required on each of the redundantly connected PCS 7 stations.

Connecting non-PRP-enabled devices

Up to 2 non-PRP-enabled devices that have only one Industrial Ethernet port, WLAN access point or infrastructure computer, such as DNS, WINS, DHCP or file server, can be integrated into a redundant, high-availability terminal bus with PRP via a SCALANCE X204RNA.

SCALANCE X204RNA is available in two product versions:

- SCALANCE X204RNA
Network access point in plastic enclosure with 4 electrical ports for connecting up to 2 non-PRP-enabled devices to redundant networks
- SCALANCE X204RNA EEC
Network access point in metal enclosure with 2 electric terminal device ports and 2 optical/electrical combo ports for network connection of up to 2 non-PRP-enabled terminal devices to redundant networks

The following constraints must be observed:

- Length of the TP cable between the network and SCALANCE X-200RNA:
 - Max. 100 m with IE FC cable and IE FC RJ45 Plug 180
 - Max. 10 m using patches with TP cord
- Length of the optical cables between the network and SCALANCE X-200RNA:
 - Max. 5 000 m with Industrial Ethernet glass fiber-optic cables (multimode)
 - Max. 26 000 m with Industrial Ethernet glass fiber-optic cables (single-mode)

SCALANCE X-200RNA is typically installed with the stations to be connected in a control cabinet.

For more information and technical specifications for the SCALANCE X204RNA, see Catalog IK PI.

SIMATIC PCS 7 system hardware

Industrial communication

Industrial Ethernet

System connection PCS 7 systems

Design (continued)

Connection of automation systems

The SIMATIC PCS 7 automation systems communicate with other subsystems of the process control system (e.g. Operator System or engineering system) via the Industrial Ethernet plant bus. The automation systems are connected to the plant bus using the CP 443-1 communication module, also redundant in the case of fault-tolerant systems. Instead of the CP 4431, CP 4431 Advanced with integrated security function (firewall and VPN) can also be used.

With the AS 410 modular automation systems, an additional layer is applied to the PCB of CPU 410-5H Process Automation (conformal coating). To match the AS 410, a CP 443-1 in the conformal coating version is therefore preferred (component of the AS bundle configuration).

Ordering data

System connection of single stations, servers and clients

Desktop adapter network adapter

for BCE and as spare part for redundant terminal bus

Intel network adapter for connection to Industrial Ethernet (10/100/1000 Mbps), with RJ45 connection and PCI express interface

CP 1623

PCI Express x1 card for connection to Industrial Ethernet (10/100/1000 Mbps), with 2-port switch (RJ45)

Article No.

A5E02639550

6GK1162-3AA00

Article No.

Licenses required in some cases for activating the functionality of the CP 1623 (communications software is part of the SIMATIC PCS 7 software)

Activation license if no redundant AS are used

SIMATIC NET HARDNET-IE S7 V16

Software for S7, open communication, OPC, PG/OP communication

Configuration software; up to 120 connections; floating license

Runtime software, software and electronic manual on DVD; license key, 2 languages (English, German) for

Windows 7 SP1, 64-bit (Professional / Enterprise / Ultimate)
Windows 10 Pro / Enterprise, Version 1809
Windows 10 Pro / Enterprise, Version 1903
Windows Server 2012 R2 Update (Standard)
Windows Server 2016 (Standard, Datacenter)
Windows Server 2019 (Standard, Datacenter)

For max. 4 CP 1623

- Goods delivery
Software and electronic manual on CD, license key on USB flash drive

- Online delivery
Software and license key download

Note:
Email address required!

6GK1716-1CB16-0AA0

6GK1716-1CB16-0AK0

Ordering data	Article No.	Article No.	
<p>Activation licenses when using redundant AS</p> <ul style="list-style-type: none"> Alternative license for <u>SIMATIC NET HARDNET-IE S7</u>: <p>SIMATIC NET HARDNET-IE S7-REDCONNECT V16 S7 communications software for fail-safe S7 communication over redundant networks with license for up to 4 Industrial Ethernet CPs</p> <p>Runtime software, 2 languages (English, German); for</p> <p>Windows 7 SP1, 64-bit (Professional / Enterprise / Ultimate) Windows 10 Pro / Enterprise, Version 1809 Windows 10 Pro / Enterprise, Version 1903 Windows Server 2012 R2 Update (Standard) Windows Server 2016 (Standard, Datacenter) Windows Server 2019 (Standard, Datacenter)</p> <p>For max. 4 CP 1623</p> <ul style="list-style-type: none"> Goods delivery Software and electronic manual on CD, license key on USB flash drive Online delivery Software and license key download Note: Email address required! Additive license for <u>SIMATIC NET HARDNET-IE S7</u> <p>SIMATIC NET HARDNET-IE S7-REDCONNECT PowerPack V16 For expansion of HARDNET-IE S7 communications software to HARDNET-IE S7-REDCONNECT, with license for up to 4 Industrial Ethernet CPs</p> <p>2 languages (English, German) for</p> <p>Windows 7 SP1, 64-bit (Professional / Enterprise / Ultimate) Windows 10 Pro / Enterprise, Version 1809 Windows 10 Pro / Enterprise, Version 1903 Windows Server 2012 R2 Update (Standard) Windows Server 2016 (Standard, Datacenter) Windows Server 2019 (Standard, Datacenter)</p> <p>For max. 4 CP 1623</p> <ul style="list-style-type: none"> Goods delivery Software and electronic manual on CD, license key on USB flash drive Online delivery Software and license key download Note: Email address required! 	<p>6GK1716-0HB16-0AA0</p> <p>6GK1716-0HB16-0AK0</p> <p>6GK1716-0HB16-0AC0</p> <p>6GK1716-0HB16-0AK1</p>	<p>System connection for plant bus communication via standard network adapter and Basic Communication Ethernet for single stations and servers which are not based on a SIMATIC PCS 7 Industrial Workstation</p> <p>SIMATIC PCS 7 BCE V9.1 Runtime license for plant bus communication via standard network adapter and Basic Communication Ethernet; already integrated with SIMATIC PCS 7 Industrial Workstations</p> <p>3 languages (English, German, French), software class A, runs with Windows 10 2019 LTSC or Windows Server 2019, floating license for 1 user</p> <ul style="list-style-type: none"> Goods delivery License key on USB flash drive, Certificate of License Online delivery License key download, online Certificate of License Note: Email address required! <p>Components for connecting SIMATIC PCS 7 stations to a redundant terminal bus with PRP</p> <p>SIMATIC NET SOFTNET-IE RNA V16 Software for connecting PCS 7 stations to PRP-enabled networks with integrated SNMP</p> <p>Runtime software, 2 languages (English, German), software class A, for</p> <p>Windows 7 SP1, 64-bit (Professional / Enterprise / Ultimate) Windows 10 Pro / Enterprise, Version 1809 Windows 10 Pro / Enterprise, Version 1903 Windows Server 2012 R2 Update (Standard) Windows Server 2016 (Standard, Datacenter) Windows Server 2019 (Standard, Datacenter)</p> <p>Single license for 1 installation</p> <p>Goods delivery Software and electronic manual on CD, license key on USB flash drive</p> <p>Industrial Ethernet SCALANCE X204RNA router With integrated SNMP access, web diagnostics and PROFINET diagnostics, for connecting non-PRP-enabled terminal devices to PRP networks; with operating instructions, Industrial Ethernet network manual and configuration software on CD</p> <ul style="list-style-type: none"> SCALANCE X204RNA with four 100 Mbps RJ45 ports SCALANCE X204RNA EEC with two 100 Mbps RJ45 ports and two RJ45/SFP combo ports 	<p>6ES7650-1CD68-2YB5</p> <p>6ES7650-1CD68-2YH5</p> <p>6GK1711-1EW16-0AA0</p> <p>6GK5204-0BA00-2KB2</p> <p>6GK5204-0BS00-3LA3</p>

SIMATIC PCS 7 system hardware

Industrial communication

Industrial Ethernet

System connection PCS 7 systems

Ordering data	Article No.	Article No.
Accessories for Industrial Ethernet SCALANCE X-204RNA network access		System connection of automation systems
IE FC TP standard cable GP 2x2 (type A) 4-wire, shielded TP installation cable for connecting to IE FC RJ45 outlet/IE FC RJ45 plug; PROFINET-compatible; with UL approval; sold by the meter; delivery unit max. 1 000 m, minimum order quantity 20 m	6XV1840-2AH10	SIMATIC NET CP 443-1 Communication module for connecting SIMATIC S7-400 to Industrial Ethernet through TCP/IP, ISO and UDP; PROFINET IO Controller, MRP; integrated real-time switch ERTEC with 2 ports; 2 x RJ45 interface; S7 communication, open communication (SEND/RECEIVE) with FETCH/WRITE, with or without RFC 1006, DHCP, SNMP V2, diagnostics, multicast, access protection over IP access list, initialization over LAN 10/100 Mbps with electronic manual on DVD
IE FC RJ45 plug 180 2x2 RJ45 plug connector for Industrial Ethernet with rugged metal enclosure and integrated insulation displacement contacts for connecting Industrial Ethernet FC installation cables; with 180° cable outlet; for network components and CPs/CPUs with Industrial Ethernet port	6GK1901-1BB10-2AA0 6GK1901-1BB10-2AB0 6GK1901-1BB10-2AE0	SIMATIC NET CP 443-1 Advanced With security functionality (firewall and VPN) Communication module for connection of SIMATIC S7-400 to Industrial Ethernet: 1 x 10/100/1000 Mbps; 4 x 10/100 Mbps (IE SWITCH); RJ45 ports; ISO; TCP; UDP; PROFINET IO controller, S7 communication; open communication (SEND/RECEIVE); S7 routing; IP configuration via DHCP/block; IP Access Control List; time synchronization; expanded web diagnostics; fast startup; PROFlenergy support; IP routing; FTP; web server; email; PROFINET CBA
SFP plug-in transceiver		
• SFP991-1 (multimode, glass, up to 3 km)	6GK5991-1AD00-8AA0	
• SFP991-1LH+ (single-mode, glass, up to 70 km, LH+)	6GK5991-1AE00-8AA0	
• SFP991-1LD (single-mode, glass, up to 26 km)	6GK5991-1AF00-8AA0	
LC plug MM²⁾	6GK1901-0RB10-2AB0	
LC plug SM²⁾	6GK1901-0SB10-2AB0	
FO Robust Cable GP 50/125/900¹⁾	6XV1873-2R	
FO Robust Cable GP 4x9/125/900¹⁾	6XV1843-2R	
SITOP compact 24 V/0.6 A Single-phase power supply with wide-range input 85 ... 264 V AC/110 ... 300 V DC, stabilized output voltage 24 V, rated output current value 0.6 A, slim-line design	6EP1331-5BA00	
C-PLUG Removable data storage medium for simple replacement of devices in the event of a fault; for storing configuration or engineering and application data; can be used for SIMATIC NET products with C-plug slot	6GK1900-0AB00	

¹⁾ Special fiber-optic cables, lengths and accessories available on request

²⁾ Special tools and specially trained personnel are required for pre-assembling glass fiber-optic cables

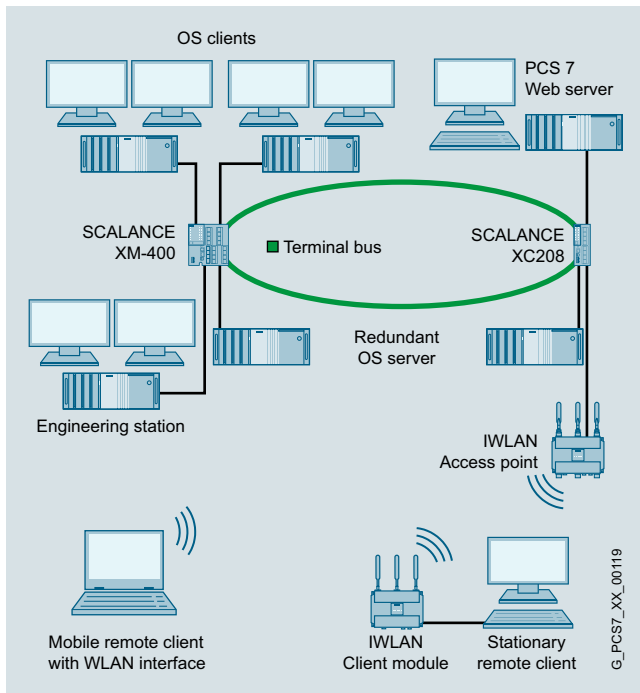
Overview

SIMATIC PCS 7 provides the option for integrating mobile or stationary remote clients via an Industrial Wireless LAN (IWLAN) access point of the SCALANCE W760, W770 or W780 product lines into the terminal bus.

The following applications, for example, can be implemented in this manner:

- Configuration of additional remote OS clients (up to 2 clients on IWLAN)
- Linking of web clients to a SIMATIC PCS 7 web server (up to 2 web clients on IWLAN)
- Remote access to an engineering station using the "RealVNC" software (Enterprise Edition), e.g., during commissioning

Mobile remote clients (e.g. notebooks) equipped with a WLAN interface can use it to communicate with the IWLAN access point. Stationary remote clients in a desktop/tower housing (SIMATIC PCS 7 Industrial Workstations) require an IWLAN client module of the SCALANCE W720, W730 or W740 production lines for communication with the IWLAN access point.

The IWLAN client modules and the IWLAN access points of the SCALANCE W700 product family are extremely rugged, use state-of-the-art authentication and encryption procedures, and ensure high wireless channel reliability. By means of link aggregation and parallel use of several antennas (MIMO technology) in accordance with the international standard IEEE 802.11n you can achieve gross data transfer rates of up to 450 Mbps.

Various designs are offered for the following operational environments:

- IWLAN client modules and access points for control cabinets
- IWLAN client modules and access points for indoor use
- IWLAN access points for outdoor use

All IWLAN access points can also be configured as IWLAN client modules.























SIMATIC PCS 7 system hardware

Industrial communication

Industrial Ethernet

Industrial Wireless LAN

Design (continued)

	Client Modules					Access Points				
						also configurable as Client Modules				
WLAN Technology	11n / Wi-Fi 4		11ac / Wi-Fi 5		11ax / Wi-Fi 6	11n / Wi-Fi 4		11ac / Wi-Fi 5		11ax / Wi-Fi 6
Product Family	SCALANCE									
	W720	W730	W740	W1740	WUM	W760	W770	W780	W1780	WAM
For enhanced environmental conditions (EEC)										
For outdoor use										
For production hall mounting										
For use in control cabinet										
Special industrial functions	iFeatures									
IPCF/IPCF-MC	•*	•	•				•	•		
IPRP	•*	•	•	•	•		•	•	•	•
Inter AP-Blocking							•	•		

* only W722

G_IK10_XX_30311

Portfolio SCALANCE W Access Points and clients W700 according to IEEE 802.11n and W1700 according to IEEE 802.11ac

The C-PLUG removable data storage medium for saving configuring data supports rapid exchange of equipment without specially trained personnel.

Furthermore, the KEY-PLUG removable data storage medium can also enable additional functions for products of the SCALANCE W700 family. A total of three KEY-PLUGs are available:

- KEY-PLUG W780 iFeatures
- KEY-PLUG W740 iFeatures
- KEY-PLUG W700 Security

Note:

Note that Industrial Wireless LAN is not approved as a terminal bus or plant bus of SIMATIC PCS 7.

Design

Product categorization according to environment of use

IWLAN products for control cabinets

The IWLAN client modules and IWLAN access points intended for installation in control cabinets are a low-cost alternative for indoor areas with less harsh environmental conditions. They are particularly suited for setting up infrastructures in which great temperature differences and protection against dust and water are less important.

IWLAN products for indoor use

IWLAN client modules and IWLAN access points of this category can be installed at the location that is most favorable for the wireless link in indoor areas. The devices with IP65 degree of protection offer exceptional protection against dust and water and tolerate large differences in temperature. The enclosure and the connectors are resistant to high levels of shock and vibration.

IWLAN products for outdoor use

The IWLAN access points designed for installation outdoors and in publicly accessible areas are extremely rugged devices for high climatic demands and can be installed at a location that is most favorable for the wireless link. They are resistant to condensation, UV radiation, and salt spray.

Design (continued)

IWLAN Client Modules

SCALANCE W721-1 RJ45/ SCALANCE W722-1 RJ45 for the control cabinet



The W721 RJ45 and W722 RJ45 client modules with IP20 degree of protection are WLAN-capable devices according to the IEEE 802.11n WLAN standard with an RJ45 connection for 10/100 Mbps for integrated solutions from the control level down to the field. They offer reliable wireless real-time communication and stability for very high bandwidth requirements. The space-saving SCALANCE W720 client modules are suitable for applications in which the device is to be mounted in the control cabinet enabling the establishment of simple, cost-efficient wireless machine networks. Thanks to their SIMATIC design, automation components, such as the SIMATIC ET 200SP can be seamlessly integrated into an industrial WLAN to save space in the control cabinet. The device offers data rates up to 150 Mbps according to WLAN standard IEEE 802.11n.

SCALANCE W734-1 RJ45 for the control cabinet



The W734-1 RJ45 client module with IP30 degree of protection is a WLAN-capable device with two RJ45 connections for 10/100 Mbps, one of which has Power-over-Ethernet according to IEEE 802.3at, for integrated solutions from the control level down to the field. It offers reliable wireless real-time communication and stability for very high bandwidth requirements. Its compact design makes it deal to use; it also offers particularly reliable transmission of wireless signals through 2 antennas (2x2:2 MIMO). The client modules in SIMATIC S7-1500 design are suitable for applications where the device is to be mounted in the control cabinet.

In perfect interaction with SIMATIC S7-1500, the device enables wireless data transmission and communication between the controller and an ET 200MP. This allows networks ranging from simple machine networks to large wireless areas to be implemented using MIMO technology with data transmission rates of up to 300 Mbps. Due to optional iFeatures provided by the KEY-PLUG W740 iFeature, it is also possible to perform wireless data transmission in real-time via PROFINET IO. (For details, see iFeatures brochure: <https://support.industry.siemens.com/cs/ww/en/view/109766392>)

Due to the compact design, the devices offer versatile mounting options using DIN mounting rail mounting adapters, angle adapters or direct screw connection to the wall. The portfolio for the client module also includes an extensive selection of antennas.

SCALANCE W738-1 M12 for indoor use



The robust SCALANCE W738 M12 client module with IP65 degree of protection is a WLAN-capable device with two M12 connections for 10/100 Mbps, one of which has Power-over-Ethernet according to IEEE 802.3at, and is designed for integrated solutions from the control level to the field. It is suitable for industrial applications outside the control cabinet at locations optimal for wireless operation.

In perfect interaction with SIMATIC S7-1500, the device enables wireless data transmission and communication between the controller and an ET 200MP. This allows networks ranging from simple machine networks to large wireless areas to be implemented using MIMO technology with data transmission rates of up to 300 Mbps. Due to optional iFeatures provided by the KEY-PLUG W740 iFeature, it is also possible to perform wireless data transmission in real-time via PROFINET IO. (For details, see iFeatures brochure: <https://support.industry.siemens.com/cs/ww/en/view/109766392>)

Due to the compact design, the devices offer versatile mounting options using DIN mounting rail mounting adapters, angle adapters or direct screw connection to the wall. The portfolio for the client module also includes an extensive selection of antennas.

IWLAN Client Modules

SCALANCE W748-1 M12 for indoor use



The robust SCALANCE W748 M12 client module with IP65 degree of protection is a WLAN-capable device with a 1 x M12 connection for 10/100/1000 Mbps with Power-over-Ethernet according to IEEE 802.3at for integrated solutions from the control level to the field. It is suitable for industrial applications outside the control cabinet.

With data rates of up to 450 Mbps and the extension of the IEEE 802.11n standard by corresponding iFeatures, the SCALANCE Client Module W740 ensures reliable wireless communication in real time and stability with very high bandwidth requirements. The iFeatures with MIMO technology mentioned above, for example, enable clients to move freely over multiple wireless cells. (For details, see iFeatures brochure: <https://support.industry.siemens.com/cs/ww/en/view/109766392>)

This opens up new areas of application both indoors and outdoors, as well as under extreme operating conditions. The SCALANCE W748 M12 can also be used to set up applications along railway lines, in holiday parks or even applications with an EMERGENCY OFF function via a mobile panel. The portfolio for the client module also includes an extensive selection of antennas.

SCALANCE W748-1 RJ45 for the control cabinet



The SCALANCE W748 RJ45 client module with IP30 degree of protection is a WLAN-compatible device with an RJ45 connection for 10/100/1000 Mbps with Power-over-Ethernet according to IEEE 802.3at for integrated solutions from the control level down to the field with easy installation in the control cabinet. It is suitable for applications in which the client module is to be mounted in the control cabinet.

With data rates of up to 450 Mbps and the extension of the IEEE 802.11n standard by corresponding iFeatures, the SCALANCE Client Module W740 ensures reliable wireless communication in real time and stability with very high bandwidth requirements. The iFeatures with MIMO technology mentioned above, for example, enable clients to move freely over multiple wireless cells. (For details, see iFeatures brochure: <https://support.industry.siemens.com/cs/ww/en/view/109766392>)

This opens up new areas of application both indoors and outdoors, as well as under extreme operating conditions. The SCALANCE W748 RJ45 can also be used to set up applications along railway lines, in holiday parks or even applications with an EMERGENCY OFF function via a mobile panel. The portfolio for the client module also includes an extensive selection of antennas.

SIMATIC PCS 7 system hardware

Industrial communication

Industrial Ethernet

Industrial Wireless LAN

Design (continued)

IWLAN Access Points

SCALANCE W761-1 RJ45 for the control cabinet



The SCALANCE W761 RJ45 access point with IP20 degree of protection and 1x RJ45 connection for 10/100 Mbps is ideally suited for setting up Industrial Wireless LAN (IWLAN) networks and for integrated solutions from the control level down to the field. The space-saving device supports 2.4 GHz and 5 GHz frequency bands and is suitable for applications where the device is to be mounted in the control cabinet.

With the SCALANCE W761 RJ45 Access Point, you have the option of implementing wireless machine networking simply and cost-effectively. The portfolio for the access point also includes a comprehensive selection of antennas. It forms the counterpart to the W721 clients for cost-effective, point-to-point connections and enables wireless commissioning on the system.

Thanks to their SIMATIC design, automation components such as an ET 200SP can be seamlessly integrated into an industrial WLAN to save space in the control cabinet. This is implemented according to the IEEE 802.11n standard and with data rates of up to 150 Mbps and can be expanded with video data thanks to the increased bandwidth.

SCALANCE W774-1 RJ45 for the control cabinet



The easy-to-install SCALANCE W774 RJ45 access point with IP30 degree of protection is a WLAN-capable device with two RJ45 connections for 10/100 Mbps, one of which has Power-over-Ethernet according to IEEE 802.3at, for integrated solutions from the control level to the field. The W774-1 RJ45 enables local wireless access to the system and coexistence with other wireless systems by supporting 2.4 GHz and 5 GHz frequency bands. The access points in the SIMATIC S7-1500 design are particularly suitable for applications in which the device is to be mounted in the control cabinet.

In perfect interaction with SIMATIC S7-1500, the device enables wireless data transmission and communication between the controller and an ET 200MP. This allows networks ranging from simple machine networks to large wireless areas to be implemented using MIMO technology with data transmission rates of up to 300 Mbps. Due to optional iFeatures provided by the KEY-PLUG W780 iFeature, it is also possible to perform wireless data transmission in real-time via PROFINET IO. (For details, see iFeatures brochure: <https://support.industry.siemens.com/cs/ww/en/view/109766392>)

SCALANCE W774 M12 EEC For an extended range of ambient conditions



The SCALANCE W774 M12 EEC compact access point with IP30 degree of protection is a WLAN-capable device with two M12 connections for 10/100 Mbps, of which one has Power-over-Ethernet according to IEEE 802.3at, which has railway approval and is suitable for mounting between walls.

In perfect interaction with SIMATIC S7-1500, the device enables wireless data transmission and communication between the controller and an ET 200MP. This allows networks ranging from simple machine networks to large wireless areas to be implemented using MIMO technology with data transmission rates of up to 300 Mbps. Due to optional iFeatures provided by the KEY-PLUG W780 iFeature, it is also possible to perform wireless data transmission in real-time via PROFINET IO. (For details, see iFeatures brochure: <https://support.industry.siemens.com/cs/ww/en/view/109766392>)

The SCALANCE W774-1 M12 EEC access points meet requirements for rolling stock for railway applications (EN 50155, E1) thanks to their conformal coating.

IWLAN Access Points

SCALANCE W778-1 M12 for indoor use



The rugged access point SCALANCE W778-1 M12 with IP65 degree of protection and two M12 connections for 10/100 Mbps, one of which has Power-over-Ethernet according to IEEE 802.3at, is ideal for setting up Industrial Wireless LAN (IWLAN) networks and for applications outside the control cabinet. Low-wear communication to mobile devices can be established through PROFINET or an EtherNet/IP connection via WLAN. The access point is suitable for simple, space-saving, cabinet-free, on-site installation in industrial and automation applications.

In perfect interaction with SIMATIC S7-1500, the device enables wireless data transmission and communication between the controller and an ET 200MP. This allows networks ranging from simple machine networks to large wireless areas to be implemented using MIMO technology with data transmission rates of up to 300 Mbps. Due to optional iFeatures provided by the KEY-PLUG W780 iFeature, it is also possible to perform wireless data transmission in real-time via PROFINET IO. (For details, see iFeatures brochure: <https://support.industry.siemens.com/cs/ww/en/view/109766392>)

Due to the IP65 compatibility and the compact design of the devices, they can be used in harsh ambient conditions and offer versatile mounting options using DIN mounting rail mounting adapters, angle adapters or direct screw connection to the wall. The portfolio for the access point also includes a comprehensive selection of antennas.

SCALANCE W778-1 M12 EEC For an extended range of ambient conditions



SCALANCE W778-1 M12

The SCALANCE W778-1 M12 EEC robust access point with IP65 degree of protection and two M12 EEC connections for 10/100 Mbps, of which one connection has Power-over-Ethernet according to IEEE 802.3at, is ideal for setting up Industrial Wireless LAN (IWLAN) wireless networks and for applications outside the control cabinet. In addition, in combination with KEY-PLUG W700 Security, the device enables increased network security when "Inter AP Blocking" is activated. The access point is suitable for use in industry and automation in general, but especially for an extended range of ambient conditions such as in the railway environment.

In perfect interaction with SIMATIC S7-1500, the device enables wireless data transmission and communication between the controller and an ET 200MP. This allows networks ranging from simple machine networks to large wireless areas to be implemented using MIMO technology with data transmission rates of up to 300 Mbps. Due to optional iFeatures provided by the KEY-PLUG W780 iFeature, it is also possible to perform wireless data transmission in real-time via PROFINET IO. (For details, see iFeatures brochure: <https://support.industry.siemens.com/cs/ww/en/view/109766392>)

Due to the IP65 compatibility and the compact design of the devices, they can be used in harsh ambient conditions and offer versatile mounting options using DIN mounting rail mounting adapters, angle adapters or direct screw connection to the wall. The portfolio for the access point also includes a comprehensive selection of antennas.

Thanks to their conformal coating, the access points SCALANCE W774-1 M12 EEC and SCALANCE W778-1 M12 EEC meet the requirements for rolling stock for railway applications (EN 50155, E1).

Design (continued)

IWLAN Access Points**SCALANCE W786-2 SFP for outdoor use**

The SCALANCE W786 SFP robust access point with IP65 degree of protection and 6 x R-SMA sockets for connecting remote antennas as well as two slots for SFP plug-in transceivers (optical 2-port switch) for integrated solutions from the control level to the field level with simple installation in the control cabinet. These access points are particularly well-suited to outdoor applications with demanding climatic requirements and in areas accessible to the public.

With data rates of up to 450 Mbps according to the IEEE 802.11n standard, the access points enable reliable, wireless data transmission in real time. The portfolio for the access point also includes a comprehensive selection of antennas and numerous mounting options for a wide range of applications.

iFeatures such as iPCF (Industrial Point Coordination Function), which are connected via the KEY-PLUG W780 iFeatures, open up new areas of application: Data transmissions along rail tracks or in holiday parks, or even applications with EMERGENCY OFF function with PROFI-safe via wireless are possible. (For details, see iFeatures brochure: <https://support.industry.siemens.com/cs/ww/en/view/109766392>)

SCALANCE W786 RJ45 for outdoor use

The SCALANCE W786 RJ45 robust access point with IP65 degree of protection and an RJ45 connection for 10/100/1000 Mbps and Power-over-Ethernet according to IEEE 802.3at for integrated solutions from the control level down to the field level with simple installation in the control cabinet. These access points are particularly well-suited to outdoor applications with demanding climatic requirements and in areas accessible to the public.

With data rates of up to 450 Mbps according to the IEEE 802.11n standard, the access points enable reliable, wireless data transmission in real time. The portfolio for the access point also includes a comprehensive selection of antennas and numerous mounting options for a wide range of applications.

iFeatures such as iPCF (Industrial Point Coordination Function), which are connected via the KEY-PLUG W780 iFeatures, open up new areas of application: Data transmissions along rail tracks or in holiday parks, or even applications with EMERGENCY OFF function with PROFI-safe via wireless are possible. (For details, see iFeatures brochure: <https://support.industry.siemens.com/cs/ww/en/view/109766392>)

Product versions:

- **SCALANCE W786-1 RJ45**
A radio card is permanently installed in the device; functional scope can be expanded using a KEY-PLUG W780 iFeature
- **SCALANCE W786-2 RJ45**
Two wireless cards permanently installed in the device; functional scope can be expanded using a KEY-PLUG W780 iFeature
- **SCALANCE W786-2IA RJ45**
Two wireless cards permanently installed in the device; six internal antennas; functional scope can be expanded using a KEY-PLUG W780 iFeature

IWLAN Access Points**SCALANCE W788 RJ45 for the control cabinet**

The robust SCALANCE W788 RJ45 access points with IP30 degree of protection and an RJ45 connection for 10/100/1000 Mbps with Power-over-Ethernet according to IEEE 802.3at are ideal for setting up Industrial Wireless LAN (IWLAN) wireless networks in which the access point is to be mounted in the control cabinet.

With data rates of up to 450 Mbps according to the IEEE 802.11n standard, the access points enable reliable, wireless data transmission in real time. The portfolio for the access point also includes a comprehensive selection of antennas and numerous mounting options for a wide range of applications.

iFeatures such as iPCF (Industrial Point Coordination Function), which are connected via the KEY-PLUG W780 iFeatures, open up new areas of application: Data transmissions along rail tracks or in holiday parks, or even applications with EMERGENCY OFF function with PROFI-safe via wireless are possible. (For details, see iFeatures brochure: <https://support.industry.siemens.com/cs/ww/en/view/109766392>)

Product versions:

- **SCALANCE W788-1 RJ45**
A radio card is permanently installed in the device; functional scope can be expanded using a KEY-PLUG W780 iFeature
- **SCALANCE W788-2 RJ45**
Two wireless cards permanently installed in the device; functional scope can be expanded using KEY-PLUG W780 iFeature

SCALANCE W788 M12 for indoor use

The robust SCALANCE W788 RJ45 access points with IP65 degree of protection and an M12 connection for 10/100/1000 Mbps with Power-over-Ethernet according to IEEE 802.3at are ideal for setting up Industrial Wireless LAN (IWLAN) wireless networks and for applications outside the control cabinet.

With data rates of up to 450 Mbps according to the IEEE 802.11n standard, the access points enable reliable, wireless data transmission in real time. The portfolio for the access point also includes a comprehensive selection of antennas and numerous mounting options for a wide range of applications.

iFeatures such as iPCF (Industrial Point Coordination Function), which are connected via the KEY-PLUG W780 iFeatures, open up new areas of application: Data transmissions along rail tracks or in holiday parks, or even applications with EMERGENCY OFF function with PROFI-safe via wireless are possible. (For details, see iFeatures brochure: <https://support.industry.siemens.com/cs/ww/en/view/109766392>)

Product versions:

- **SCALANCE W788-1 M12**
A radio card is permanently installed in the device; functional scope can be expanded by using a KEY-PLUG W780 iFeature
- **SCALANCE W788-2 M12**
Two wireless cards permanently installed in the device; functional scope can be expanded using a KEY-PLUG W780 iFeature

SIMATIC PCS 7 system hardware

Industrial communication

Industrial Ethernet

Industrial Wireless LAN

Design (continued)

IWLAN Access Points

SCALANCE W788 M12 EEC

For an extended range of ambient conditions



The SCALANCE W788 RJ45 robust access point with IP65 degree of protection and an M12 connection for 10/100/1000 Mbps with Power-over-Ethernet according to IEEE 802.3at Type 2 is ideally suited for setting up Industrial Wireless LAN (IWLAN) wireless networks and for applications outside the control cabinet. It also has an extended temperature range, special approvals and conformal coating. This enables wireless on-site networking of plant components in particularly harsh industrial environments and makes it suitable for use in industrial and automation applications, especially in railway environments.

With data rates of up to 450 Mbps according to the IEEE 802.11n standard, the access points enable reliable, wireless data transmission in real time. The portfolio for the access point also includes a comprehensive selection of antennas and numerous mounting options for a wide range of applications.

iFeatures such as iPCF (Industrial Point Coordination Function), which are connected via the KEY-PLUG W780 iFeatures, open up new areas of application: Data transmissions along rail tracks or in holiday parks, or even applications with EMERGENCY OFF function with PROFIsafe via wireless are possible. (For details, see iFeatures brochure:

<https://support.industry.siemens.com/cs/ww/en/view/109766392>)

Ordering data

Article No.

Article No.

IWLAN Client Modules

SCALANCE W721-1 RJ45 for the control cabinet

IWLAN Ethernet client module with integrated wireless interface; wireless networks
IEEE 802.11a/b/g/h/n at 2.4/5 GHz up to 150 Mbps; WPA2/AES; IP20 degree of protection (0 to +55 °C)

Product package: Mounting hardware, 3-pin screw terminal for 24 V DC; manual on CD; English/German

For administration of the wireless connection of one device with Industrial Ethernet connection

- National approvals for operation outside the U.S.
- National approvals for operation within the U.S.¹⁾

6GK5721-1FC00-0AA0

6GK5721-1FC00-0AB0

SCALANCE W722-1 RJ45 for the control cabinet

IWLAN Ethernet client module with iFeatures support and integrated wireless interface; wireless networks
IEEE 802.11a/b/g/h/n at 2.4/5 GHz up to 150 Mbps; WPA2/AES; IP20 degree of protection (0 to +55 °C)

Product package: Mounting hardware, 3-pin screw terminal for 24 V DC; manual on CD; English/German

For administration of the wireless connection of one device with Industrial Ethernet connection; with iFeatures

- National approvals for operation outside the U.S.
- National approvals for operation within the U.S.¹⁾
- Country approvals for operation in Israel²⁾

6GK5722-1FC00-0AA0

6GK5722-1FC00-0AB0

6GK5722-1FC00-0AC0

SCALANCE W734-1 RJ45 for the control cabinet

IWLAN Ethernet client module with integrated wireless interface; wireless networks
IEEE 802.11a/b/g/h/n at 2.4/5 GHz up to 300 Mbps; WPA2/AES; integrated 2-port switch; Power over Ethernet (PoE), IP30 degree of protection (-20 to +60 °C)

Product package: Mounting hardware, 4-pin screw terminal for 24 V DC; manual on CD; English/German

For managing the wireless connection of up to eight linked devices with Industrial Ethernet connection

- National approvals for operation outside the U.S.
- National approvals for operation within the U.S.¹⁾

6GK5734-1FX00-0AA0

6GK5734-1FX00-0AB0

SCALANCE W738-1 M12 for indoor use

IWLAN Ethernet client module with integrated wireless interface; wireless networks
IEEE 802.11a/b/g/h/n at 2.4/5 GHz up to 300 Mbps; WPA2/AES; Power over Ethernet (PoE), IP65 degree of protection (-30 to +65 °C)

Product package: Mounting hardware; manual on CD; English/German

IWLAN Access Point with one integrated wireless interface

- National approvals for operation outside the U.S.
- National approvals for operation within the U.S.¹⁾

6GK5738-1GY00-0AA0

6GK5738-1GY00-0AB0

Ordering data	Article No.	Article No.
<p>SCALANCE W748-1 M12 for indoor use IWLAN Ethernet client module with integrated wireless interface; wireless networks IEEE 802.11a/b/g/h/n at 2.4/5 GHz up to 450 Mbps; WPA2/AES; Power over Ethernet (PoE), IP65 degree of protection (-20 to +60 °C)</p> <p>Product package: Mounting hardware; manual on CD, English/German</p> <p>For managing the wireless connection of up to eight linked devices with Industrial Ethernet connection</p> <ul style="list-style-type: none"> National approvals for operation outside the U.S. National approvals for operation within the U.S.¹⁾ 	<p>6GK5748-1GD00-0AA0</p> <p>6GK5748-1GD00-0AB0</p>	<p>SCALANCE W774-1 RJ45 for the control cabinet IWLAN access point with an integrated wireless interface for establishing wireless connections with iFeatures; wireless networks IEEE 802.11a/b/g/h/n at 2.4/5 GHz up to 300 Mbps; WPA2/AES; integrated 2-port switch; Power over Ethernet (PoE), IP30 degree of protection (-20 to +60 °C)</p> <p>Product package: Mounting hardware, 4-pin screw terminal for 24 V DC; manual on CD; English/German</p> <p>IWLAN access point with one built-in wireless interface</p> <ul style="list-style-type: none"> National approvals for operation outside the U.S. National approvals for operation within the U.S.¹⁾ Country approvals for operation in Israel¹⁾
<p>SCALANCE W748-1 RJ45 for the control cabinet IWLAN Ethernet client module with integrated wireless interface; wireless networks IEEE 802.11a/b/g/h/n at 2.4/5 GHz up to 450 Mbps; WPA2/AES; Power over Ethernet (PoE), IP30 degree of protection (-20 to +60 °C)</p> <p>Product package: Mounting hardware; 4-pin screw terminal for 24 V DC, 4-pin screw terminal for digital input and output; manual on CD, German/English</p> <p>For administration of the wireless connection of up to eight devices with Industrial Ethernet connection; IP30 degree of protection</p> <ul style="list-style-type: none"> National approvals for operation outside the U.S. National approvals for operation within the U.S.¹⁾ 	<p>6GK5748-1FC00-0AA0</p> <p>6GK5748-1FC00-0AB0</p>	<p>SCALANCE W774-1 M12 EEC for an extended range of ambient conditions IWLAN access points with built-in wireless interface; wireless networks IEEE 802.11a/b/g/h/n at 2.4/5 GHz up to 300 Mbps; railway approval in accordance with EN 50155; conformal coating; WPA2/AES; Power over Ethernet (PoE), IP20 degree of protection</p> <p>Product package: Mounting hardware; manual on CD-ROM, English/German</p> <p>IWLAN Access Point with one integrated wireless interface</p> <ul style="list-style-type: none"> National approvals for operation outside the U.S. National approvals for operation within the U.S.¹⁾
<p>IWLAN Access Points</p>		
<p>SCALANCE W761-1 RJ45 for the control cabinet IWLAN access point with integrated wireless interface; wireless networks IEEE 802.11a/b/g/h/n at 2.4/5 GHz up to 150 Mbps; WPA2/AES; IP20 degree of protection (0 to +55 °C)</p> <p>Product package: Mounting hardware, 3-pin screw terminal for 24 V DC; manual on CD; English/German</p> <p>IWLAN Access Point with one integrated wireless interface</p> <ul style="list-style-type: none"> National approvals for operation outside the U.S. National approvals for operation within the U.S.¹⁾ 	<p>6GK5761-1FC00-0AA0</p> <p>6GK5761-1FC00-0AB0</p>	<p>SCALANCE W778-1 M12 for indoor use IWLAN access point with built-in wireless interface (radio); IEEE 802.11a/b/g/h/n wireless network with 2.4/5 GHz up to 300 Mbps; 2x M12 max. 100 Mbps; M12 A-coded; plug slot WPA2/802.11i/e; integrated Power over Ethernet (PoE) 2-port switch; 2 N-CON antenna port, iFeatures support via KEY-PLUG; IP65 degree of protection; redundant 24 V DC; -20 to 60 °C</p> <p>Product package: Manuals on CD-ROM, English/German; M12 caps</p> <p>IWLAN Access Point with one integrated wireless interface</p> <ul style="list-style-type: none"> National approvals for operation outside the U.S. National approvals for operation within the U.S.¹⁾

SIMATIC PCS 7 system hardware

Industrial communication

Industrial Ethernet

Industrial Wireless LAN

Ordering data	Article No.	Article No.
<p>SCALANCE W778-1 M12 EEC for an extended range of ambient conditions IWLAN access point with built-in wireless interface (radio); IEEE 802.11a/b/g/h/n wireless network with 2.4/5 GHz up to 300 Mbps; 2x M12 max. 100 Mbps; M12 A-coded; plug slot WPA2/802.11i/e; integrated Power over Ethernet (PoE) 2-port switch; 2 N-CON antenna port, iFeatures support via KEY-PLUG; IP65 degree of protection; redundant 24 V DC; -30 to 75 °C; conformal coating; EN 50155; EN45545 Product package: Manuals on CD-ROM, English/German; M12 caps</p> <ul style="list-style-type: none"> National approvals for operation outside the U.S. National approvals for operation within the U.S.¹⁾ 	<p>6GK5778-1GY00-0TA0</p> <p>6GK5778-1GY00-0TB0</p>	<ul style="list-style-type: none"> SCALANCE W786-2IA RJ45 IWLAN access point with two integrated wireless interfaces and RJ45 connection Six internal antennas <ul style="list-style-type: none"> National approvals for operation outside the U.S. National approvals for operation within the U.S.¹⁾ <p>6GK5786-2HC00-0AA0</p> <p>6GK5786-2HC00-0AB0</p>
<p>SCALANCE W786-2 SFP for outdoor use IWLAN access points with built-in wireless interfaces; wireless networks IEEE 802.11a/b/g/h/n at 2.4/5 GHz up to 450 Mbps; WPA2/AES; Power over Ethernet (PoE), IP65 degree of protection (-40°C to +60°C) Product package: Mounting hardware, 2-pin screw terminal for 24 V DC; manual on CD-ROM; English/German IWLAN access points with two integrated wireless interfaces and RJ45 connector, six external antennas</p> <ul style="list-style-type: none"> National approvals for operation outside the U.S. National approvals for operation within the U.S.¹⁾ 	<p>6GK5786-2FE00-0AA0</p> <p>6GK5786-2FE00-0AB0</p>	<ul style="list-style-type: none"> SCALANCE W788-1 RJ45 IWLAN access point with one integrated wireless interface <ul style="list-style-type: none"> National approvals for operation outside the U.S. National approvals for operation within the U.S.¹⁾ SCALANCE W788-2 RJ45 IWLAN access point with two integrated wireless interfaces <ul style="list-style-type: none"> National approvals for operation outside the U.S. National approvals for operation within the U.S.¹⁾ Country approvals for operation in Israel¹⁾ <p>6GK5788-1FC00-0AA0</p> <p>6GK5788-1FC00-0AB0</p> <p>6GK5788-2FC00-0AA0</p> <p>6GK5788-2FC00-0AB0</p> <p>6GK5788-2FC00-0AC0</p>
<p>SCALANCE W786 RJ45 for outdoor use IWLAN access points with built-in wireless interfaces; wireless networks IEEE 802.11a/b/g/h/n at 2.4/5 GHz up to 450 Mbps; WPA2/AES; Power over Ethernet (PoE), IP65 degree of protection (-40°C to +60°C) Product package: Mounting hardware, 2-pin screw terminal for 24 V DC; manual on CD-ROM; English/German</p> <ul style="list-style-type: none"> SCALANCE W786-1 RJ45 IWLAN access points with one integrated wireless interface and RJ45 connector Connection for three external antennas <ul style="list-style-type: none"> National approvals for operation outside the U.S. National approvals for operation within the U.S.¹⁾ SCALANCE W786-2 RJ45 IWLAN access points with two integrated wireless interfaces and RJ45 connector, six connections for external antennas <ul style="list-style-type: none"> National approvals for operation outside the U.S. National approvals for operation within the U.S.¹⁾ Country approvals for operation in Israel¹⁾ 	<p>6GK5786-1FC00-0AA0</p> <p>6GK5786-1FC00-0AB0</p> <p>6GK5786-2FC00-0AA0</p> <p>6GK5786-2FC00-0AB0</p> <p>6GK5786-2FC00-0AC0</p>	<p>SCALANCE W788 M12 for indoor use IWLAN access point with integrated wireless interfaces; wireless networks IEEE 802.11a/b/g/h/n at 2.4/5 GHz up to 450 Mbps; WPA2/AES; Power over Ethernet (PoE), IP65 degree of protection (-20 to +60 °C) Product package: Mounting hardware; manual on CD, English/German</p> <ul style="list-style-type: none"> SCALANCE W788-1 M12 IWLAN access point with one integrated wireless interface <ul style="list-style-type: none"> National approvals for operation outside the U.S. National approvals for operation within the U.S.¹⁾ SCALANCE W788-2 M12 IWLAN access point with two integrated wireless interfaces <ul style="list-style-type: none"> National approvals for operation outside the U.S. National approvals for operation within the U.S.¹⁾ <p>6GK5788-1GD00-0AA0</p> <p>6GK5788-1GD00-0AB0</p> <p>6GK5788-2GD00-0AA0</p> <p>6GK5788-2GD00-0AB0</p>

Ordering data	Article No.	Article No.
SCALANCE W788 M12 EEC for an extended range of ambient conditions IWLAN access points with built-in wireless interfaces; wireless networks IEEE 802.11a/b/g/h/n at 2.4/5 GHz up to 450 Mbps; railway approval in accordance with EN 50155 / NEMA TS2; conformal coating; WPA2/AES; Power over Ethernet (PoE), IP65 degree of protection Product package: Mounting hardware; manual on CD-ROM, English/German IWLAN dual access point with two integrated wireless interfaces <ul style="list-style-type: none"> National approvals for operation outside the U.S. National approvals for operation within the U.S.¹⁾ 	6GK5788-2GD00-0TA0 6GK5788-2GD00-0TB0	MS1 mounting set Mounting set for fixing the SCALANCE W786 products onto an S7-300 mounting rail or a 35 mm DIN mounting rail Power supply PS791-2DC power supply 24 V DC power supply for installation in SCALANCE W786 products; operating instructions in English/German PS791-2AC power supply 110 to 230 V AC power supply for installation in SCALANCE W786 products; operating instructions in English/German Connection components SFP plug-in transceiver for SCALANCE W786-2 SFP <ul style="list-style-type: none"> SFP992-1 Gigabit, multimode, 750 m SFP992-1LD Gigabit, single-mode, 10 km SFP992-1LH Gigabit, single-mode, 40 km SFP992-1LH+ Gigabit, single-mode, 70 km
Accessories KEY-PLUG W740 iFeatures Swap medium for enabling additional iFeatures, for simple device replacement if a fault occurs and for storage of configuration data; can be used in SCALANCE W client modules with PLUG compartment	6GK5907-4PA00	6GK5992-1AL00-8AA0 6GK5992-1AM00-8AA0 6GK5992-1AN00-8AA0 6GK5992-1AP00-8AA0
KEY-PLUG W780 iFeatures Swap medium for enabling additional iFeatures, for simple device replacement if a fault occurs and for storage of configuration data; can be used in SCALANCE W access points with PLUG compartment	6GK5907-8PA00	Fiber-optic cables See Catalog IK PI, Industrial Ethernet, cabling systems, glass fiber-optic cables
KEY-PLUG W700 Security Removable data storage medium for enabling security features for SCALANCE W700 access points, for simple device replacement if a fault occurs, and for storing configuration data	6GK5907-0PA00	IE FC RJ45 plug 180 2x2 RJ45 plug connector for Industrial Ethernet with a rugged metal enclosure and integrated insulation-displacement contacts for connecting Industrial Ethernet FC installation cables; with a 180° cable outlet; for network components and CPs/CPUs with Industrial Ethernet interface <ul style="list-style-type: none"> 1 pack = 1 unit 1 pack = 10 units 1 pack = 50 units
C-PLUG Swap medium for simple replacement of devices in the event of a fault; for storing configuration data; can be used in SIMATIC NET products with PLUG compartment	6GK1900-0AB00	IE FC standard cable GP 2x2 4-core, shielded TP installation cable for connection to IE FC outlet RJ45 plug/IE FC RJ45 plug; PROFINET-compliant; with UL approval; sold by the meter; max. quantity 1 000 m, minimum order quantity 20 m
Standard DIN mounting rail mounting adapter Standard DIN mounting rail mounting adapter for SCALANCE W788 M12 and SCALANCE W788 RJ45; screw fixing for mounting on a 35 mm DIN mounting rail in accordance with EN 50022 Product package: 3 units per pack	6GK5798-8ML00-0AB3	IE FC RJ45 plug 4x2 Industrial Ethernet FastConnect RJ45 plug 180 4x2, RJ45 connector; CAT6A; (10/100/1000/10000 Mbps) with rugged metal enclosure and FC connection technology, for IE FC cable 4x2 (AWG24); 180° cable outlet <ul style="list-style-type: none"> 1 pack = 1 unit 1 pack = 10 units 1 pack = 50 units
Standard mounting rail angled adapter 90° angled adapter for mounting DIN mounting rails, only for use with SCALANCE W778/W778EEC/W738; and DIN mounting rail mounting adapter for 35 mm DIN mounting rail Product package: Fixing screws	6GK5798-8MA00-0AA1	IE FC M12 plug PRO 4x2 M12 plug connector suitable for on-site assembly (X-coded, IP65/IP67), metal enclosure, insulation/displacement fast connection method, for SCALANCE W <ul style="list-style-type: none"> 1 unit 8 units
Standard DIN mounting rail mounting adapter Standard DIN mounting rail mounting adapter, only for use in combination with SCALANCE W778/W778EEC/W738 Product package: Fixing screws	6GK5798-8MF00-0AA1	6GK1901-1BB10-2AA0 6GK1901-1BB10-2AB0 6GK1901-1BB10-2AE0 6XV1840-2AH10 6GK1901-1BB12-2AA0 6GK1901-1BB12-2AB0 6GK1901-1BB12-2AE0 6GK1901-0DB30-6AA0 6GK1901-0DB30-6AAB

SIMATIC PCS 7 system hardware

Industrial communication

Industrial Ethernet

Industrial Wireless LAN**Ordering data****Article No.****IE FC standard cable GP 4x2**

8-core (4x2), shielded
TP installation cable
for connection to IE FC
RJ45 plug 4x2 and IE M12 plug
PRO 4x2; PROFINET-compliant;
with UL approval; sold by the meter;
max. length 1 000 m,
minimum order quantity 20 m

6XV1878-2A**Power M12 Cable Connector PRO**

Socket for connection of
SCALANCE W-700 for 24 V DC
supply; 4-pin, A-coded, with
mounting instructions, 3 units

6GK1907-0DC10-6AA3**Power cable 2x0.75**

Connecting cable for Power M12
Cable Connector PRO, sold by
the meter

6XV1812-8A**IE FC stripping tool**

Pre-adjusted stripping tool
for fast stripping of the Industrial
Ethernet FC cables

6GK1901-1GA00**Antennas and miscellaneous
IWLAN accessories**

For IWLAN access points
and IWLAN client modules

See Catalog IK PI, Industrial Wireless
LAN, accessories**More information**

For further information and detailed technical specifications on the IWLAN products for SIMATIC PCS 7, refer to Catalog IK PI, the Industry Mall or Catalog CA 01 under "Industrial Communication > Industrial Wireless Communication > Industrial Wireless LAN".

Selection tools

The SIMATIC NET Selection Tool and the TIA Selection Tool are available to assist in selecting the right IWLAN components:

- <http://www.siemens.com/snst-standalone>
- <http://www.siemens.com/tia-selection-tool-standalone>
- <http://www.siemens.com/tstcloud>

Radio approvals

Current approvals can be found on the Internet:

- German: <http://www.siemens.de/funkzulassungen>
- English: <http://www.siemens.com/wireless-approvals>

¹⁾ Please note country approvals under:
<http://www.siemens.com/wireless-approvals>

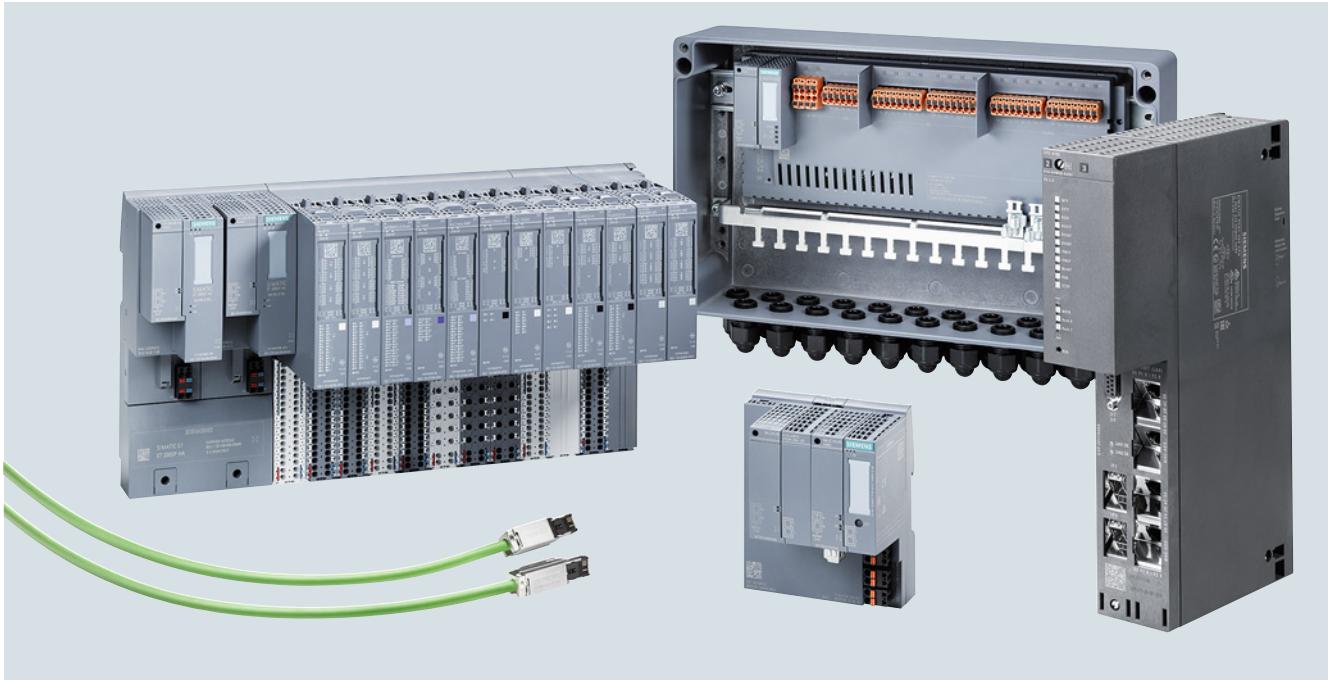
Overview

PROFINET in the process industry

PROFINET combines the advantages of PROFIBUS, the most popular fieldbus system worldwide, with modern Ethernet technology. PROFINET supports easy setup of flexible communication networks and ensures integrated, reliable and secure communication throughout the plant – in real time!

Greater flexibility, efficiency and performance in industrial communication – PROFINET has proven itself for many years in the manufacturing and machine environment and is the preeminent global standard in automation.

PROFINET more than meets the special requirements of the process industry regarding availability, flexibility, real-time capability and ruggedness. At the same time, the Ethernet-based technology provides easy handling.

With version 9.0 of SIMATIC PCS 7, the process industry can now also benefit from the latest communication technology since the conditions for this are now in place:

- Scalable system redundancy
- Changes possible in runtime ("Configuration in Run")
- High-precision time-of-day synchronization for sequence of events ("SoE")

The hardware portfolio has undergone fundamental further development in order to make full use of the new PROFINET options:

- CPU 410-5H V8.2
- SIMATIC ET 200SP HA
- SIMATIC CFU PA
- SCALANCE XF204-2BA DNA ("Y-switch")

Benefits

- Ethernet at the field level
 - Integrated vertical and horizontal communication
 - Transmission of large amounts of data in real time
- Maximum availability if required
 - Changes during runtime
 - Freely scalable redundancy enables large cost reductions thanks to optimized custom solutions
- More flexibility
 - One shared plant network ensures free assignment of the devices to the controllers and makes it easy to expand the plant
 - Topologies are based on requirements and plant specification, which can result in savings of 60 % and more in cabling!
 - "One cable for all purposes" means better cost efficiency
- User-friendly
 - Simple device integration and fast device replacement during operation
 - Installation wizards and integrated device/network diagnostics
 - Implementation of secure communication layer in accordance with IEC 61784-3-3 (PROFIsafe)
- Investment protection
 - Integration of existing structures and technologies
 - Gradual transition from PROFIBUS DP to PROFINET

SIMATIC PCS 7 system hardware

Industrial communication

PROFINET

Application

PROFINET completely adheres to the Ethernet standard in accordance with IEEE 802.3, which makes it the reliable future-proof standard that paves the way for digitalization in the process environment.

Combine investment protection with security for the future: on the one hand, the open Industrial Ethernet standard supports the integration of existing plant parts and technologies. Appropriate solutions and products, such as the IE/PB LINK for integration of PROFIBUS DP and the SIMATIC CFU PA for integration of PROFIBUS PA, are available for this. On the other hand, worldwide standardization in accordance with IEC 61158/61784 and consistent ongoing development ensure the use of PROFINET over the entire life cycle of the plant and beyond. Even wireless communication technologies such as WLAN in accordance with IEEE 802.11 and mobile communications can be reliably integrated.

Wired communication is also easier and more cost-effective with PROFINET: the motto "One cable for all purposes" supports parallel operation of profiles such as PROFI-safe, PROFIdrive and other TCP/IP protocols without impacting basic plant communication.

There is also greater convenience: the PROFINET diagnostics available by default simplify installation and provide support for plant servicing. Network problems and device conflicts are reliably detected and can be quickly remedied. This also forms the basis for preventive maintenance. These benefits are worth the investment over the service life of the plant.

Customized to your requirements

PROFINET allows you to freely scale the availability of your plant based on your requirements. In addition to media redundancy (MRP), two forms of system redundancy are also available:

- Simple system redundancy (S2)
- Modular system redundancy (R1)

"Configuration in Run" allows you to implement plant changes during runtime without affecting process engineering.

Flexible architectures can potentially allow significant savings in wiring. This is confirmed by reference projects. In one case, 27 km of wiring (with PROFIBUS DP) could be reduced to 9 km through the use of PROFINET. Flexible architectures also support easier plant expansion without the need for spares.

The new hardware components use the BusAdapter technology, which enables easy and flexible connection to the PROFINET network either with copper cables (RJ45 or FastConnect) or fiber-optic cable.

Function

Digitalization in the process industry significantly increases the amount of data (big data), requires continuous communication all the way to the field and needs flexible and secure communication networks. PROFINET is the answer:

- The best of both worlds
 - Compatible with PROFIBUS
 - Integrated device/network diagnostics
 - High data rates for more data, digital and in real time
 - Fail-safe communication is possible without special network components
- Standardization
 - Based on standard Ethernet according to IEEE 802.3
 - Preeminent open field bus standard worldwide
 - Supports IT services, for example TCP/IP
- Straightforward handling
 - Support during planning, operation and commissioning with automatic addressing and name assignment
 - Easy device replacement without additional tools with automatic neighborhood detection
 - Clear and simple installation guidelines

Overview

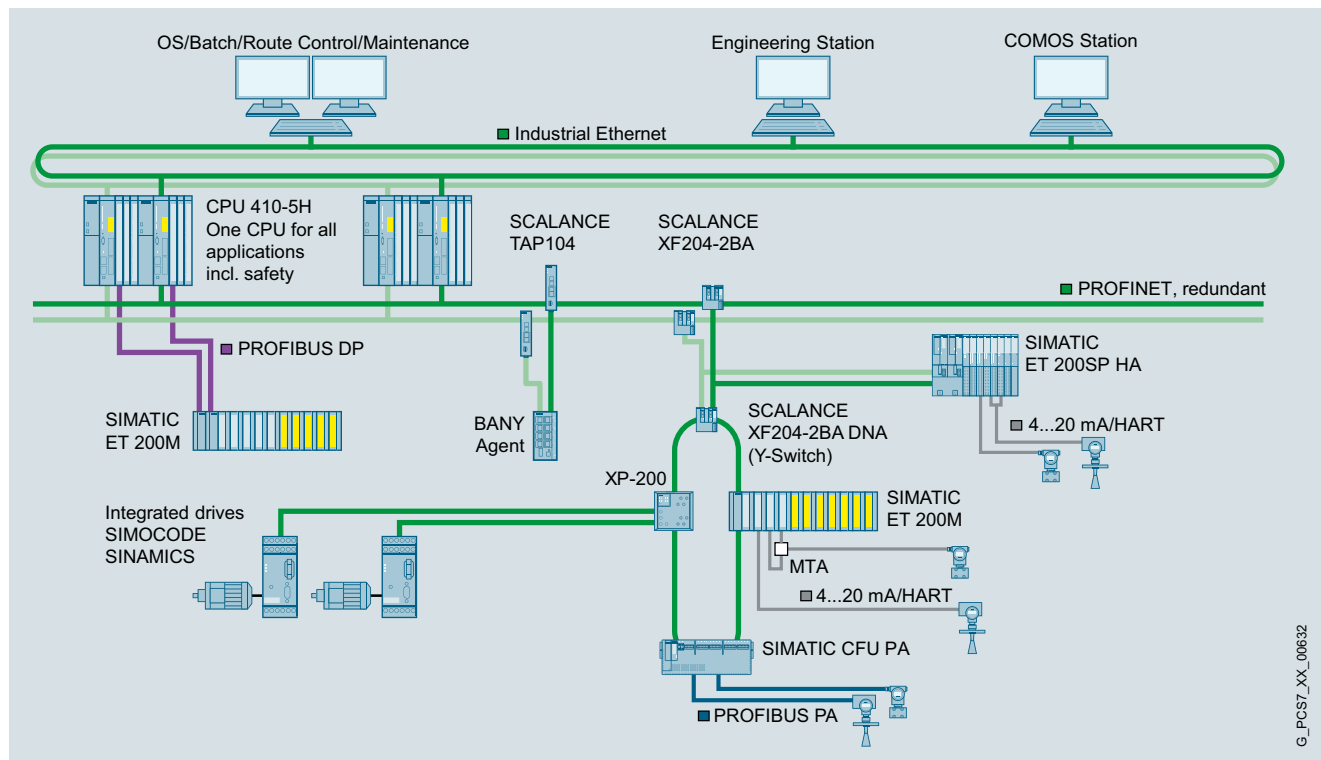

PROFINET in the process industry

When configuring PROFINET communication, it is generally recommendable to separate the field communication from the plant communication. In the context of the SIMATIC PCS 7 process control system, PROFINET mainly focuses on PROFINET IO communication between the automation systems (controllers) and the process I/O.

System components of SIMATIC PCS 7 with PROFINET capability

The SIMATIC PCS 7 system components suitable for PROFINET IO communication include:

- Automation systems (AS single stations and AS redundancy stations) with CPU 410-5H (firmware version V8.2) for complete PROFINET functionality
- SIMATIC PCS 7 AS RTX PROFINET and SIMATIC PCS 7 BOX RTX with PROFINET interface onboard
- SIMATIC ET 200SP HA with IM 155-6 PN interface module and BusAdapter
- SIMATIC CFU PA with BusAdapter
- SIMATIC ET 200M with IM 153-4 PN High Feature interface module
- SIMATIC ET 200SP with BusAdapter

In addition to specific PROFINET products, Industrial Ethernet products can also be used as network components, for example SCALANCE X switches and media converters, and FastConnect connecting elements, as well as electrical and optical transmission media (see "Industrial communication" chapter, "Industrial Ethernet", or "PROFINET/Industrial Ethernet" in the IK PI catalog).

Add-on product for SIMATIC PCS 7

In addition to the SIMATIC PCS 7 system components for PROFINET communication included in this catalog, the ST PCS 7 AO catalog includes add-on products for SIMATIC PCS 7 which support the integration of further PROFINET IO stations, e.g.

- SIMOCODE pro block library for integration of the SIMOCODE pro V PN motor management system via PROFINET IO
- Drive ES PCS 7 APL with function blocks and faceplates for integration of variable-speed SINAMICS drives via PROFINET IO
- Block library LIBRARY PAC/3WL/3VA SIMATIC PCS 7 for integration of 3VA power switches and 7KM PAC3200/4200 measuring devices
- AS-Interface block library for integration of AS-i slaves (sensors/actuators) via the IE/AS-i LINK PN IO (single or double master) on the PROFINET IO

G_PCS7_XX_00632

SIMATIC PCS 7 system hardware

Industrial communication
PROFINET



PROFINET switches

Overview

Industrial Ethernet/PROFINET switches specially designed for use in the process industry

To ensure full PROFINET functionality, special SCALANCE X switches, FastConnect connection elements and electrical and optical transmission media are available as network components for the connection of devices with PROFINET capability to automation systems (AS single stations and AS redundancy stations) with CPU 410-5H (firmware version V8.2).

The following switches are recommended for use with SIMATIC PCS 7 with PROFINET at the field level. These devices support the relevant functions to enable full use of the possibilities provided by PROFINET.

	SCALANCE XF204-2BA SCALANCE XF204-2BA DNA	SCALANCE XC-200 SCALANCE XC-200EEC	SCALANCE XP-200
			
Installation	Control cabinet	Control cabinet	Outside control cabinet
Degree of protection	IP20	IP20	IP65
ATEX Zone 2	Yes	Yes	Yes
Interfaces	Electrical/optical with BusAdapter	Electrical/optical/SFPs	Electrical
Number of ports	4 (2 BA)	Max. 24, of which 2 Gbit ports (SFP)	Max. 16, of which 4 Gbit ports
Port characteristics	Depending on the type of Bus-Adapter (BA)	Max. 24 RJ45 Max. 2 SFP	8 × M12 D-coded or 12 × M12 D-/ 4 × M12 X-coded
SFPs	No	Yes	No
Use of BusAdapter (BA)	Yes	No	No
Temperature range	-40 to +70 °C	-40 to +70 °C	-40 to +70 °C
Conformal coating PCBs	Yes	Yes, for EEC versions	Yes, for EEC versions
PA ready	Yes	Yes	Yes
Dimensions W × H × D (in mm)	100 × 117 × 74	60/120 × 147 × 125	200/280 × 200 × 49

A description of the components specified can be found in the "Industrial Ethernet" section or under "PROFINET/Industrial Ethernet" in the IK PI catalog.

PA ready

For unrestricted use in process automation, IO devices must support at least the following functionalities:

- Simple system redundancy S2
- Media Redundancy Protocol (MRP)
- Configuration in RUN (CiR)

Siemens uses the PA ready symbols to uniquely identify the IO devices that meet the requirements of process automation with regard to availability and changes during operation.

Siemens thus places comparable requirements on PROFINET IO devices in process automation – e.g. PROFIBUS & PROFINET International (PI). The PI subdivides IO devices into conformance classes (CC) depending on their range of functions: CC-A, CC-B and CC-C. There is also the CC-B (PA), an extension of the CC-B, designed particularly for process automation. It includes the system redundancy requirement and MRP and Configuration in Run as options.

Less stringent requirements for PA ready apply if IO devices are connected at the end of a line or in a star topology:

Modular end devices (e.g. ET 200SP HA)

- Simple system redundancy S2
- Configuration in RUN (CiR)

Compact end devices (e.g. SIMOCODE)

- Simple system redundancy S2

Service bridge based on SCALANCE XC-200

The SCALANCE XC-200 has an important role in architecture with PROFINET since it can be specially configured as a "service bridge".

An example of SCALANCE XC208 configuration as a service bridge can be found in the Siemens Industry Online Support.

Overview

The SCALANCE XF204-2BA DNA from Siemens is a new compact Industrial Ethernet switch specially designed for use with redundant SIMATIC S7-400H systems in process automation. It follows the recommendations of NAMUR NE 21 and is therefore suitable for use in process automation. The switch with dual network access functionality (DNA or Y-switch functionality) combines a redundant PROFINET ring, consisting of S2 devices (field level), with a high-availability PROFINET system (R1 system).

- Connection of up to two modular BusAdapters (2 ports each) supported
- Enclosure in SIMATIC ET 200SP design (slim design, 100 mm wide) for space-saving use in small control boxes
- Integrated redundancy manager for configuring Fast Ethernet ring topologies with fast media redundancy MRP on device side
- End-to-end system diagnostics with PROFINET, SNMP access, integrated web server, SINEMA Server or SINEC NMS and automatic email transmission function for remote diagnostics and signaling via the network
- XF-200BA DNA versions are optimized for use in process automation and feature the following properties:
 - Conformal coating PCBs
 - Max. installation altitude 4 000 m - extended temperature range from -40 °C to +70 °C
 - NAMUR NE 21-compliant
 - Firmware support for S2 device and CiR/H-CiR
 - Release and integration capability in SIMATIC PCS 7 and PCS neo

The following BusAdapters are currently released for use with SCALANCE XF204-2BA DNA:

- SIMATIC ET 200SP HA, BusAdapter BA 2xRJ45, 2 RJ45 sockets
- SIMATIC ET 200SP HA, BusAdapter BA 2xFC, 2 FastConnect connections
- SIMATIC BA 2xRJ45VD HA, 2 RJ45 sockets with VD technology (variable distance)
- SIMATIC ET 200SP, BusAdapter BA 2XRJ45, 2x RJ45 sockets
- SIMATIC ET 200SP, BusAdapter BA 2xFC, 2x FastConnect connections
- SIMATIC ET 200SP, BusAdapter BA SCRJ/RJ45, 1x SCRJ FO connection and 1x RJ45 connection
- SIMATIC ET 200SP, BusAdapter BA SCRJ/FC, 1x SCRJ FO connection and 1x FastConnect (FC) connection
- SIMATIC ET 200SP, BusAdapter BA 2xSCRJ, 2 SCRJ FO connections
- SIMATIC ET 200SP, BusAdapter BA 2xLC (as of function status 05), 2x LC FO connection, (as of function status 05)
- SIMATIC ET 200SP, BusAdapter BA LC/RJ45, 1xRJ45, 1x LC FO connection, (as of function status 05)
- SIMATIC ET 200SP, BusAdapter BA LC/FC, 1xRJ45 FastConnect, 1x LC FO connection, (as of function status 05)
- SIMATIC ET 200SP HA, BusAdapter, BA 2xLC, 2x LC FO connection, (as of function status 05)

Product variant
SCALANCE XF204-2BA DNA

- PROFINET S2 devices are switched to a high-availability R1 system with the SCALANCE XF204-2BA DNA (DNA = Dual Network Access).

SIMATIC PCS 7 system hardware

Industrial communication
PROFINET

SCALANCE XF-200BA DNA (Y-Switch) switches

Benefits

get Designed for Industry

- Integration of S2 devices in a highly available automation system, thus minimizing downtimes and increasing productivity in process automation
- Setup of networks in SIMATIC PCS 7/neo systems with extended environmental conditions (conformal coating)
- Small frame size (SIMATIC ET 200SP design and BusAdapter concept)
- Simple, flexible integration into automation solutions through selection of different BusAdapters
- Modular design with BusAdapters allows efficient spare part storage by using the same BusAdapter in multiple devices
- Approvals for ATEX Zone 2/IECEX, cULus HazLoc, FM, thus use in Zone 2 hazardous areas possible
- Conforms to NAMUR NE 21, integration in all conventional process control systems, such as SIMATIC PCS 7 and PCS neo
- Time savings during engineering, commissioning and in the operating phase of a plant by using the configuration and diagnostics integrated in STEP 7/TIA Portal
- Integration into the SINEMA Server or SINEC NMS network management system for integrated network diagnostics with central firmware management
- The 2xRJ45VD HA BusAdapter permits PROFINET communication up to 500 m
- Integration of switches in systems with simple S2 system redundancy and Configuration in Run (CiR/HCiR)
- Since Configuration in Run (CiR/H-CiR) is supported, PROFINET-defined configuration changes to the switch are performed during operation
- Easy integration in the process and system diagnostics with PROFINET via SIMATIC PCS 7 and PCS neo

Design

The SCALANCE XF204-2BA DNA managed Industrial Ethernet switch is designed for mounting on a standard DIN rail. With its SIMATIC ET 200SP format enclosure (slim design), the device is optimally suited for integration in automation solutions in small control boxes, e.g. together with the SIMATIC ET 200SP.

- The SCALANCE XF204-2BA DNA switch with its rugged plastic enclosure with IP20 degree of protection is optimized for mounting on standard DIN rails. Thanks to the dimensions of the SIMATIC ET 200SP enclosure, the devices are ideally suited for integration into an automation solution with SIMATIC ET 200SP components.

The SCALANCE XF204-2BA DNA switch is available with the following port types/interfaces:

- 2 BusAdapter interfaces
- Variant with two premounted BusAdapters BA 2xRJ45 HA

Ordering data	Article No.	Article No.
<p>SCALANCE XF-204-2BA DNA <i>Industrial Ethernet switch</i></p> <p>Manageable Y-switch for linking S2 devices to an S7-400H with 2 x BusAdapter interfaces, 24 V DC redundant power supply, PN device, extended temperature range, conformal coating</p> <p>Configuration software on CD-ROM</p> <ul style="list-style-type: none"> • SCALANCE XF204-2BA DNA 4 x 10/100 Mbps, 2 x BusAdapter interface, fault signaling contact, Set button, redundant 24 V DC power supply, PROFINET device, extended temperature range -40°C ... +70°C, conformal coating, with electronic manual on DVD, C-PLUG optional, supplied without BusAdapter • SCALANCE XF204 DNA Two BA 2xRJ45 HA BusAdapters premounted 6DL1193-6AR00-0AA0, 4 x 10/100 Mbps, 2 x BusAdapter interface, fault signaling contact, Set button, redundant 24 V DC power supply, PROFINET device, extended temperature range 40°C ... +70°C, conformal coating, with electronic manual on DVD, C-PLUG optional, supplied with BusAdapter 	<p>6GK5204-2AA00-2YF2</p> <p>6GK5204-0BA00-2YF2</p>	<p>ET 200SP, BusAdapter BA SCRJ/FC</p> <p>SIMATIC ET 200SP, BusAdapter: BA SCRJ/FC, media converter FOC-CU 1x SCRJ FO connection and 1x FastConnect (FC) connection for PROFINET</p> <p>C-PLUG (CONFORMAL COATING)</p> <p>C-PLUG removable data storage medium for simple replacement of devices in the event of a fault; for storing configuration or application data; can be used for SIMATIC NET products with C-PLUG slot, conformal coating</p> <p>IE TP Cord RJ45/RJ45</p> <p>Pre-assembled 8-wire Cat6_A patch cable 4 x 2, with two RJ45 plugs, preferred length</p> <ul style="list-style-type: none"> • 0.3 m • 0.5 m • 1 m • 2 m • 3 m • 4 m • 6 m • 10 m • 15 m • 20 m • 25 m • 30 m • 35 m • 40 m • 45 m • 50 m <p>FO Standard Cable GP 50/125/1400</p> <p>Multimode cable, sold by the meter; max. delivery unit 1 000 m, minimum order quantity 20 m, also available pre-assembled with LC plugs in various lengths</p> <p>SCALANCE TAP104</p> <p>Test access port for the reaction- free extraction of Ethernet data frames (10/100 Mbps) from both transmission directions; extracts complete data traffic, including faulty frames, for further diagnostics.</p>
<p>6ES7193-6AP40-0AA0</p> <p>6GK1900-0AQ00</p> <p>6XV1870-3QE30 6XV1870-3QE50 6XV1870-3QH10 6XV1870-3QH20 6XV1870-3QH30 6XV1870-3QH40 6XV1870-3QH60 6XV1870-3QN10 6XV1870-3QN15 6XV1870-3QN20 6XV1870-3QN25 6XV1870-3QN30 6XV1870-3QN35 6XV1870-3QN40 6XV1870-3QN45 6XV1870-3QN50</p> <p>6XV1873-2A</p> <p>6GK5104-0BA00-1SA2</p>		
<p>Accessories</p> <p>SIMATIC ET 200SP PS 24 V/5 A</p> <p>Stabilized power supply Input: 120/230 V AC Output: 24 V DC/5 A</p> <p>SIMATIC ET 200SP HA, BusAdapter BA 2xRJ45, 2 RJ45 sockets</p> <p>PROFINET BusAdapter with Ethernet socket for standard RJ45 plug, with conformal coating PCBs</p> <p>SIMATIC ET 200SP HA, BusAdapter BA 2xFC, 2 FastConnect connections</p> <p>PROFINET BusAdapter with FastConnect Ethernet connection for direct bus cable connection, with conformal coating PCBs</p> <p>BusAdapter BA 2xRJ45VD HA</p> <p>BusAdapter with coated PCBs (conformal coating) and VD technology for connecting 2, 4 and 8-wire cables via standard RJ45 plugs</p> <p>ET 200SP, BusAdapter BA 2xSCRJ</p> <p>SIMATIC ET 200SP, BusAdapter BA 2xSCRJ, 2 SCRJ FO connections for PROFINET</p> <p>ET 200SP, BusAdapter BA SCRJ/RJ45</p> <p>SIMATIC ET 200SP, BusAdapter BA SCRJ/RJ45, media converter FOC-CU 1x SCRJ FO connection and 1x RJ45 connection for PROFINET</p>	<p>6EP7133-6AB00-0BN0</p> <p>6DL1193-6AR00-0AA0</p> <p>6DL1193-6AF00-0AA0</p> <p>6GK5991-2VA00-8AA2</p> <p>6ES7193-6AP00-0AA0</p> <p>6ES7193-6AP20-0AA0</p>	

Notes:

- You can find more information on the FastConnect range in the <https://support.industry.siemens.com/cs/document/109766358/ordering-overview-cabling-technology-for-communication-networks-in-industry?dti=0&lc=en-DE> ordering overview
- You can order supplementary components for the SIMATIC NET cabling range from your local contact. Technical advice on this subject is available from:
J. Hertlein
DI PA CI PRM 4
Tel.: +49 (172) 3172810
Email: juergen.hertlein@siemens.com

SIMATIC PCS 7 system hardware

Industrial communication
PROFINET

IE/PB LINK

Overview



IE/PB Link HA and IE/PB Link PN IO

IE/PB LINKs are gateways for connecting the two network types, Industrial Ethernet and PROFIBUS, i.e. they enable access to all PROFIBUS nodes connected to the lower-level PROFIBUS network.

Product versions

Two versions offered as gateways for Industrial Ethernet and PROFIBUS:

- **IE/PB LINK PN IO**
Gateway with PROFINET IO functionality, S7 routing and data record routing for standard ambient conditions
- **IE/PB LINK HA**
Gateway optimized for use in the process industry due to the possibility of deployment in harsh ambient conditions and the connection of PROFIBUS field devices to a redundant AS as PROFINET IO controller

Both product versions can be used in two operating modes:

Standard mode enables, for example, loading of programs and configuration data via PG/OP communication, data record routing for configuration and diagnostics of field devices with the SIMATIC PDM tool, S7 routing e.g. for cross-network loading of SIMATIC PLCs on PROFIBUS.

When operated as a PROFINET IO proxy, from the perspective of the PN IO controller, all PROFIBUS DP slaves connected after the IE/PB LINK are treated as PN IO devices according to the PROFINET standard, i.e. the IE/PB LINK is the proxy of the connected PROFIBUS DP slaves.

Both IE/PB LINK versions offer the possibility to use different transmission media by employing BusAdapters.

Benefits

g e t Designed for Industry

- Protection of investment due to simple connection of PROFIBUS DP slaves to PROFINET IO controller. This enables a step-by-step transition to modern PROFINET networks
- Independence from individual vendors through support of the PROFINET standard for distributed field devices
- Flexible use due to different connection system and hardware; copper (RJ45, FC) and fiber-optic cables (SCRJ for POF/PCF, LC for glass fiber-optic)
- Also enables use in plants with PROFIsafe applications
- Worldwide access to data of the PROFIBUS stations via Industrial Ethernet and Internet for vertical integration
- Access to process data from all enterprise levels
- Loading of STEP 7 programs from a central location
- Easy engineering and extensive diagnostics options due to optimum TIA integration

IE/PB LINK HA also offers:

- High availability through redundancy mechanisms in PROFINET IO through use as S2 device
- Interruption-free plant operation in the redundant system, even when configuration changes are required during operation, through support for Configuration in Run (H-CiR)
- Easy migration of large PROFIBUS networks to PROFINET by supporting up to 125 PROFIBUS DP slaves
- Reliable operation even in harsh ambient conditions

Design

Both IE/PB LINK versions provide all the advantages of the SIMATIC ET 200SP design:

- Compact design; the front of the rugged plastic enclosure features:
 - Two RJ45 ports for connecting to Industrial Ethernet; the connection is made via the IE FC RJ45 plug 90 with 90° cable outlet or via a standard patch cable
 - A 9-pin sub-D socket for connection to PROFIBUS
 - A 4-pin terminal strip for connecting the external redundant supply voltage of 24 V DC (two infeeds)
 - Diagnostics LEDs
- Optional connection possibility for Industrial Ethernet via BusAdapter (BA) of the SIMATIC ET 200SP system at the front
- Easy installation on standard mounting rails
- Can be operated without a fan
- Fast device replacement in the event of a fault by using the optional C-PLUG removable data storage medium (not included in scope of supply)

Ordering data	Article No.	Accessories	Article No.
IE/PB Link PN IO Gateway between Industrial Ethernet and PROFIBUS, PROFINET IO proxy with real-time communication, time synchronization via SIMATIC protocol, NTP, SNMP V1, LLDP, S7 routing, data record routing, connection of up to 64 S7/DPV0/DPV1 slaves, support for DP/PA LINK and DP/FF LINK, 10/100 Mbps Fast Ethernet, MRP, 9.6 Kbps up to 12 Mbps PROFIBUS, firmware download via configuration tool, redundant power supply, firmware version V4.0 Gateway	6GK1411-5AB10	C-PLUG Removable data storage medium for easy device replacement if a fault occurs. For storing configuration and application data. Can be used in the following SIMATIC NET products with C-PLUG slot: SCALANCE XC-200, XP-200, XM-400, XR-500, M-800, W-700, SC-600 and S615	6GK1900-0AB10
IE/PB LINK HA Gateway between Industrial Ethernet and PROFIBUS, PROFINET IO proxy with real-time communication, system redundancy S2, H-CiR, time synchronization via SIMATIC protocol, NTP, SNMP V1, LLDP, S7 routing, data record routing, connection of up to 125 S7/DPV0/DPV1 slaves, support for DP/PA LINK and DP/FF LINK, 10/100 Mbps Fast Ethernet, MRP, 9.6 Kbps up to 12 Mbps PROFIBUS, firmware download via configuration tool, redundant power supply, conformance coating, extended temperature range -40 C to 70 C	6GK1411-5BB00	BusAdapter BusAdapters offer a free selection of connection system and hardware for the PROFINET interface. Alternatively, they can be used for the Industrial Ethernet interface on the device. The following BusAdapter versions are supported by the IE/PB LINK PN IO: <u>Versions with copper connection (RJ45, FastConnect (FC))</u> <ul style="list-style-type: none"> • BA 2xRJ45 with 2 RJ45 connections • BA 2xFC with 2 FastConnect connections • BA 2xRJ45 HA with 2 RJ45 sockets • BA 2xFC HA with 2x FastConnect connection • SIPLUS BusAdapter BA 2xRJ45 with 2 RJ45 connections • SIPLUS BusAdapter BA 2xFC with 2 FastConnect connections • BA 2xRJ45 VD HA BusAdapter VD (variable distance), for Ethernet communication via 2-, 4- or 8-wire copper cables, 2xRJ45 sockets <u>Versions with fiber-optic connection (FO)</u> <ul style="list-style-type: none"> • BA 2xLC with LC glass fiber-optic connection • BA 2xSCRJ with 2 x SCRJ FO connection40 • BA 2xLC HA with 2 x LC glass fiber-optic connections • SIPLUS BusAdapter BA 2xLC with LC glass fiber-optic connection • SIPLUS BusAdapter BA2SCRJ with 2 x SCRJ FO connection <u>Media converter versions</u> <ul style="list-style-type: none"> • BA LC/RJ45 Media converter glass fiber-optic cable / CU for 1 x LC FO connection and 1 x RJ45 connection • BA LC/FC Media converter glass fiber-optic cable / CU 1 x LC FO connection and 1 x RJ45 connection • BA SCRJ/RJ45 Media converter fiber-optic cable / CU for 1 x SCRJ FO connection and 1 x RJ45 connection • BA SCRJ/FC Media converter fiber-optic cable / CU 1 x SCRJ FO connection and 1 x FastConnect connection • BA LC/RJ45 HA Media converter glass fiber-optic cable / CU, 1 x LC FO connection and 1 x RJ45 connection • BA LC/FC HA Media converter glass fiber-optic cable / CU, 1 x LC FO connection and 1 x FastConnect connection 	6ES7193-6AR00-0AA0 6ES7193-6AF00-0AA0 6DL1193-6AR00-0AA0 6DL1193-6AF00-0AA0 6AG1193-6AR00-7AA0 6AG1193-6AF00-7AA0 6GK5991-2VA00-8AA2 6ES7193-6AG00-0AA0 6ES7193-6AP00-0AA0 6DL1193-6AG00-0AA0 6AG1193-6AG00-2AA0 6AG1193-6AP00-2AA0 6ES7193-6AG20-0AA0 6ES7193-6AG40-0AA0 6ES7193-6AP20-0AA0 6ES7193-6AP40-0AA0 6DL1193-6AG20-0AA0 6DL1193-6AG40-0AA0

SIMATIC PCS 7 system hardware

Industrial communication
PROFINET

PROFINET Bus Analyzer (BANY)

Overview



BANY Agents without TAP/with TAP, BANY Bus Analyzer Agent XM-400

PROFINET offers the manufacturing and process industry new ways to set up flexible and high-performance plant networks to meet stricter increased security requirements. To ensure that these functions are reliable and secure from the outset, and can be easily checked and optimized over the course of the plant life cycle, Siemens provides high-performance products for the validation, analysis and continuous diagnosis of simple and high-availability PROFINET networks. The PROFINET Bus Analyzer (BANY) detects critical states in your network before an overload occurs or indeed a section of the network fails.

Benefits

- Permanent network monitoring for preventive maintenance and avoiding faults
- Online analysis of network quality in real time
- Rapid fault analysis and performance improvements during plant operation
- Clear status and event display of all devices installed in the network
- Simulation of PROFINET communication with various different loads
- Checking configured cycle time on the basis of the frame deviation (jitter) measured
- Validation of network including logging

Design

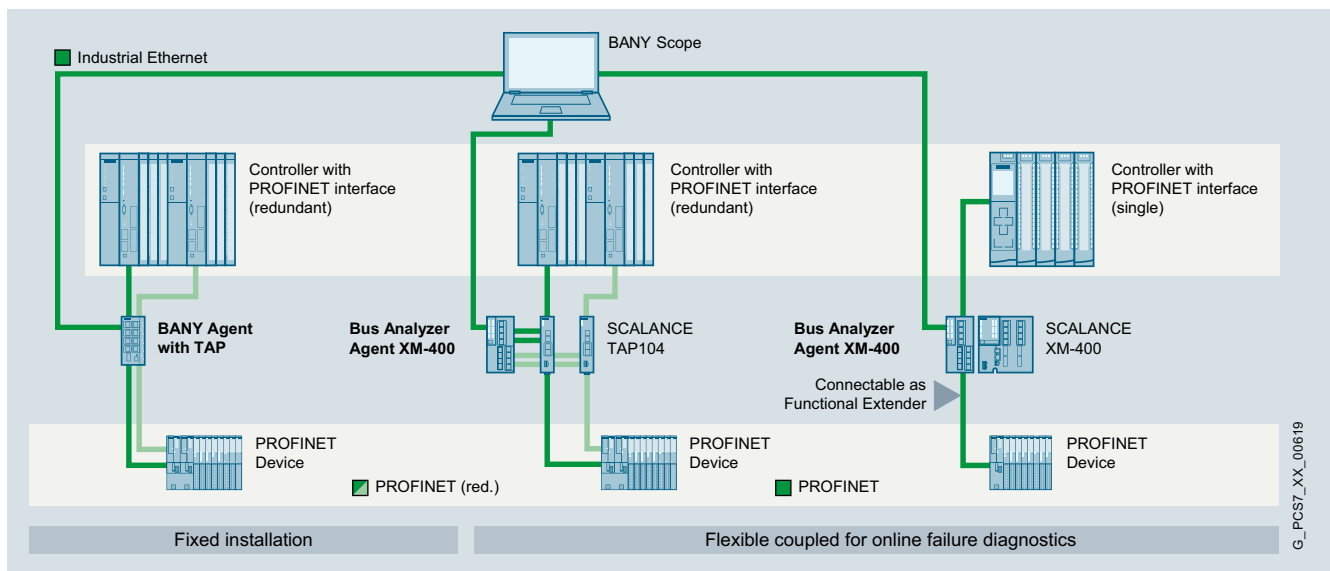

PROFINET Bus Analyzer (BANY)

Design (continued)

BANY Agent

The BANY Agent hardware can be permanently integrated into the network for permanent plant monitoring. In the event of a fault, it can even be installed retroactively via a SCALANCE TAP104 or as a functional extender (Bus Analyzer Agent XM-400 only) on SCALANCE XM-400 switches for diagnosis during plant operation. Disconnection or interruption of the network in question is thus avoided and errors are rapidly analyzed so there are no long reproduction attempts.

BANY Agent enables the reaction-free extraction and evaluation of all frame communication online in real time. Thanks to two integrated TAPs (test access points), redundant PROFINET networks can also be evaluated.

BANY Scope

BANY Scope software enables access to multiple BANY Agents in the plant. This makes it possible to rapidly identify and eliminate error sources in the PROFINET networks in any part of the plant. The quality of the network can be quickly determined at any time on the basis of key data (network load, frame error, jitter, etc.).

For the validation of PROFINET networks, validation protocols are automatically created in accordance with the PROFINET planning and commissioning guidelines. Stress tests with differently simulated network loads can be carried out with the signal generator. This allows potential weak points to be identified and eliminated before the productive phase and ensures that plant availability meets strict requirements from the outset.

Validation is rounded off with the free PRONETA software, which automatically scans and clearly documents the topology, configuration and performance parameters of the PROFINET network. This allows qualified installation and efficient approval.

Function

- Frame recording in internal memory or on external memory media (USB) with exact time stamping (resolution 10 ns)
 - Comprehensive trigger functions for filtering the recorded data
 - Interface to Wireshark and other export functions for detailed frame analysis
- Real-time PROFINET analysis for automatic calculation of all relevant bus parameters (frame number, frame error, network load, cycle time, jitter, etc.) in tables and diagrams
- Signal generator for performing offline and online stress tests (measurement of the frame run time, analysis of PROFINET RT and IRT with different network loads)
- Device lists for displaying device names, IP addresses, MAC addresses, device status, events, interruptions, and failures
- Online value monitoring in real time without affecting actual communication performance
- Control interface using script or TCP commands

Ordering data
Article No.

BANY Agent without TAP
 Ethernet 2-channel, without TAP
 (Test Access Point), signal generator

9AE4140-1BA00

BANY Agent with TAP
 2-channel integrated TAP
 (test access point),
 Ethernet 2-channel

9AE4140-1BA01

BANY Bus Analyzer Agent XM-400
 2-channel integrated TAP,
 Ethernet 4-channel, functional
 extender interface, 4 × SFP slots,
 signal generator

9AE4140-2AA00

Article No.

SCALANCE TAP104
 Test access port for frame export,
 2 × RJ45 ports, 10/100 Mbps,
 LED diagnostics,
 24 V DC power supply, manual

6GK5104-0BA00-1SA2

SIMATIC PCS 7 system hardware

Industrial communication

PROFINET

PROFINET Bus Analyzer (BANY)**Technical specifications**

Article No.	9AE4140-1BA01	9AE4140-1BA00	9AE4140-2AA00
	BANY Agent with TAP	BANY Agent without TAP	BANY Bus Analyzer Agent XM-400
Mounting options	<ul style="list-style-type: none"> DIN standard mounting rail 35 mm¹⁾ SIMATIC S7-300 mounting rail Wall 	<ul style="list-style-type: none"> DIN standard mounting rail 35 mm¹⁾ SIMATIC S7-300 mounting rail Wall 	<ul style="list-style-type: none"> DIN standard mounting rail 35 mm¹⁾ SIMATIC S7-300 mounting rail SIMATIC S7-1500 mounting rail
Degree of protection	IP20	IP20	IP20
Connectors for terminal devices or network components			
<ul style="list-style-type: none"> Electrical (over twisted pair) 	7 x RJ45 sockets with MDI-X assignment 10/100/1 000 Mbps (half/full duplex)	3 x RJ45 sockets with MDI-X assignment 10/100/1 000 Mbps (half/full duplex)	5 x RJ45 ports with MDI-X assignment 10/100/1 000 Mbps (half/full duplex) 4 x RJ45 ports with MDI-X assignment 10/100 Mbps (half/full duplex)
<ul style="list-style-type: none"> Electrical 	1 x USB	1 x USB	USB 1.1 and USB 2.0, max. 500 mA
Electrical specifications			
Supply voltage	24 V DC	24 V DC	24 V DC (20.4 ... 28.8 V DC)
<ul style="list-style-type: none"> Redundant power supply unit Redundant power supply possible 	No No	No No	No No
Overcurrent protection of the power supply	2 A / 32 V	2 A / 32 V	2 A / 32 V
Voltage over digital input/output	24 V DC	24 V DC	24 V DC
<ul style="list-style-type: none"> Switching capacity (resistive load) 	50 mA	50 mA	50 mA
Voltage at USB port	5 V DC	5 V DC	
<ul style="list-style-type: none"> Output current, max. 	500 mA	500 mA	
Current consumption	0.5 mA	0.3 mA	1 A
<ul style="list-style-type: none"> Power loss 	12 W	7.2 W	24 W
Permissible ambient conditions			
Storage/transport temperature	-40 to +70 °C	-40 to +70 °C	-40 to +85 °C
Operating temperature			
<ul style="list-style-type: none"> Horizontal installation 	-40 to +70 °C	-40 to +70 °C	-40 to +50 °C (stand-alone mode) -40 to +60 °C (XM400 function extender mode)
<ul style="list-style-type: none"> Vertical installation 	-40 to +50 °C	-40 to +50 °C	--
Max. ambient temperature at operating altitude			
<ul style="list-style-type: none"> Horizontal installation 2 000 m and higher 	65 °C	65 °C	50 °C (stand-alone mode) 60 °C (XM400 function extender mode)
<ul style="list-style-type: none"> Horizontal installation 3 000 m and higher 	60 °C	60 °C	50 °C
<ul style="list-style-type: none"> Vertical installation 2 000 m and higher 	45 °C	45 °C	--
<ul style="list-style-type: none"> Vertical installation 3 000 m and higher 	40 °C	40 °C	--
Max. relative humidity during operation at 25 °C	< 95% (no condensation)	< 95% (no condensation)	< 95% (no condensation)
Dimensions and weight			
Dimensions W x H x D in mm	60 x 125 x 125	40 x 125 x 125	70 x 150 x 125
Weight	1 400 g	1 100 g	750 g

¹⁾ Not for use in shipbuilding

Overview

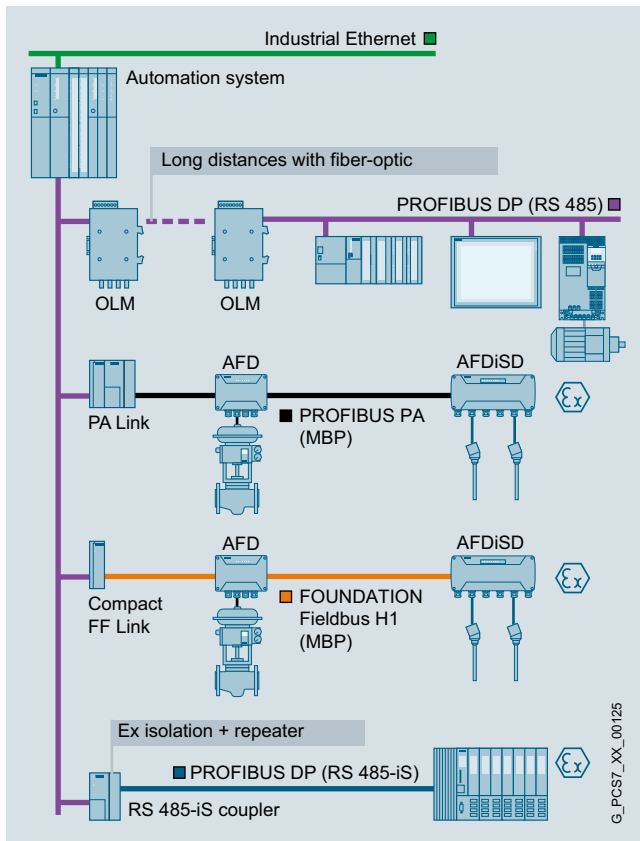

Communication at field level with PROFIBUS

Distributed peripherals such as remote I/O stations with their I/O modules, transmitters, drives, valves or operator terminals communicate with the automation systems (controllers) at field level through a powerful real-time bus system. This communication is characterized by:

- Cyclic transmission of process data
- Acyclic transfer of alarms, parameters and diagnostic data

PROFIBUS is predestined for these tasks because it enables high-speed communication with the intelligent distributed I/Os by means of a communications protocol (PROFIBUS DP) as well as communication and simultaneous power supply for transmitters and actuators (PROFIBUS PA).

PROFIBUS is simple, rugged and reliable, can be expanded online by further distributed components, and can be used in both standard environments and hazardous areas. It supports the coexistence of field devices from different vendors on one line (interoperability) as well as the vendor-independent exchangeability of devices from one profile family.

Benefits

SIMATIC PCS 7 utilizes the benefits of the PROFIBUS from start to finish:

- Small planning and engineering overheads as well as low commissioning costs
- Optimum distributed system structure with low hardware and space requirements
- Significantly reduced overheads for wiring, patching, distribution, power supply and field mounting
- High-speed communication with high measurement accuracy
- Efficient engineering, interoperability and replaceability of devices due to vendor-independent device description
- Short commissioning times due to short loop tests, simple parameter assignment and the absence of calibration work
- Bidirectional communication and high information content permit enhanced diagnostics functions for fast fault identification and elimination
- Optimum life cycle management thanks to processing and evaluation of diagnostics and status information by the maintenance station

Function

Users have numerous facilities for communication and line diagnostics, as well as for diagnostics of the intelligent field devices connected. Furthermore, the PROFIBUS is fully integrated into the global asset management with the maintenance station of the SIMATIC PCS 7 process control system.

For process automation, the following PROFIBUS functions are particularly relevant in addition:

- Integration of previously installed HART devices
- Redundancy
- Safety-related communication with PROFIsafe up to SIL 3 according to IEC 61508
- Time-of-day synchronization
- Time stamp

PROFIBUS transmission systems

PROFIBUS DP

- **RS 485**
Simple and low-cost electrical transmission system based on shielded two-wire cable.
- **RS 485-iS**
Intrinsically-safe electrical transmission system for hazardous areas up to Ex Zone 1 or 21, implemented using a shielded two-wire cable with a transmission rate of 1.5 Mbps.
- **Fiber-optic**
Optical transmission system with glass or plastic fiber-optic cables, for fast transmission of large quantities of data in environments with high interferences or for covering long distances.

PROFIBUS PA

- **MBP (Manchester coded; bus powered)**
Intrinsically-safe transmission system which permits simultaneous transmission of digital data and powering of the field devices by means of a two-wire cable. It is suitable for direct connection of devices in environments up to Ex Zone 1 or 21 and associated sensors/actuators in environments up to Ex Zone 0 or 20.

SIMATIC PCS 7 system hardwareIndustrial communication
PROFIBUS**PROFIBUS DP****Application**

The PROFIBUS DP fieldbus enables the SIMATIC PCS 7 automation systems (controllers) to communicate with distributed I/Os from the ET 200 range (remote I/Os) as well as with field/process devices, CPUs/CPs and operator terminals that have a PROFIBUS DP interface. With the aid of the fieldbus isolating transformer (RS 485-iS coupler) and the RS 485-iS transmission system, PROFIBUS DP can be run as an intrinsically-safe fieldbus in all environments up to Ex Zone 1 or 21.

Controller communication with intelligent distributed devices on PROFIBUS PA, FOUNDATION Fieldbus H1 or HART I/Os is also implemented via PROFIBUS DP.

In a SIMATIC PCS 7 automation system, PROFIBUS DP lines can be connected to distributed process I/O both via a PROFIBUS DP interface in the CPU and via a CP 443-5 Extended communications module. On a PROFIBUS DP line, it is possible to operate up to 125 devices, and up to 31 devices with a PROFIBUS DP interface on one bus segment (32 nodes).

Electrical and optical transmission technologies offer many different configuration options for PROFIBUS DP networks. Electrical networks can span up to approx. 10 km. With optical transmission systems, the total size of the network is governed primarily by the cycle times as a result of the almost loss-free transmission.

With SIMATIC PCS 7, PROFIBUS DP topologies are always implemented through the standard electrical PROFIBUS DP connection on the automation system in the form of electrical or mixed (electrical/optical) networks. In the case of mixed networks, the transition between the two media is implemented by an optical link module (OLM). In regard to the communication between the nodes, there is no difference between electrical two-wire technology and fiber-optic technology.

Electrical networks can be configured with a line or tree topology. Mixed electrical/optical networks with OLMs as routers can be configured with a line, ring or star topology.

Technical specifications

PROFIBUS DP			
	RS 485	RS 485-iS	Fiber-optic
Data transmission			
Transmission rate	9.6 Kbps ... 12 Mbps	9.6 Kbps ... 1.5 Mbps	9.6 Kbps ... 12 Mbps
Cable	2-wire shielded	2-wire shielded	Plastic as well as multi-mode and single-mode glass-fiber
Type of protection		EEx(ib)	
Topology	Line, tree	Line	Ring, star, linear
Nodes per segment	32	32 ¹⁾	–
Nodes per network (with repeater)	126	126	126
Cable length per segment depending on transfer rate	1 200 m at max. 93.75 Kbps 1 000 m at 187.5 Kbps 400 m at 500 Kbps 200 m at 1.5 Mbps 100 m at 12 Mbps	1 000 m at 187.5 Kbps ¹⁾ 400 m at 500 Kbps ¹⁾ 200 m at 1.5 Mbps ¹⁾	Max. 80 m (plastic) 2 ... 3 km (multimode glass fiber) > 15 km at 12 Mbps (single-mode glass-fiber)
Repeater for signal boosting with RS 485 networks	Max. 9	Max. 9 ¹⁾	Not relevant

¹⁾ According to PROFIBUS installation guideline 2.262

Overview

The simple and cost-effective 2-wire RS 485 transmission system is exceptionally suitable for networks with a linear/tree structure and high data transmission rates. Shielded, twisted pair cables are used as the transmission medium. The PROFIBUS DP nodes are connected to these bus cables using bus connectors.

Design

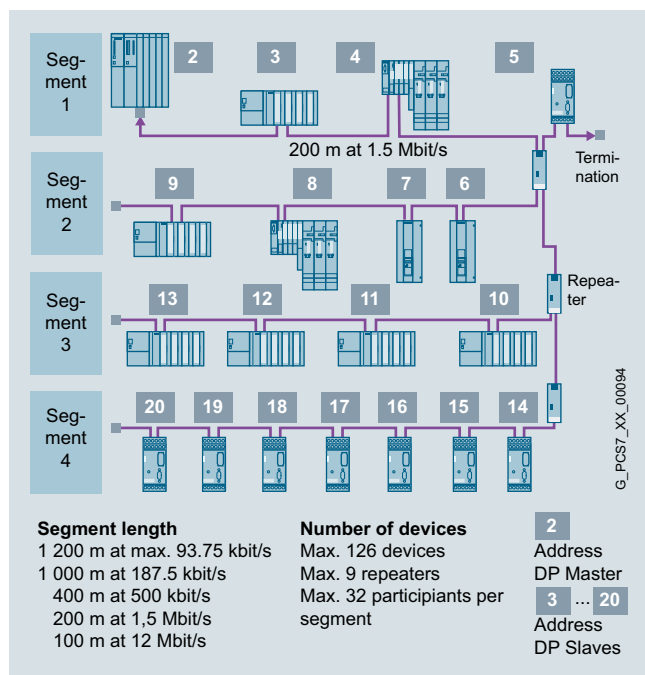

Configuration example of an electrical RS 485 network with linear/tree structure

The network size with an electrical RS 485 network is in total smaller than that with an optical network. However, by using segmenting and signal regeneration with up to 9 repeaters, distances from 1 km (at 12 Mbps) up to 10 km (at 187.5 Kbps) can be achieved depending on the transmission rate.

A segment can have up to 32 nodes (master/slaves), and the total network up to 126 nodes. The start and end of each segment must be terminated by an active bus resistor which is typically integrated in the device (e.g. repeater) or is available as an active RS 485 termination element.

The configuration example (figure above) shows a typical addressing scheme made up of multiple segments. Although repeaters are electrical nodes on the PROFIBUS, they are not assigned a slave address since they are not directly addressed by the master.

FastConnect



FastConnect Stripping Tool

PROFIBUS FastConnect is a system for fast and easy assembly of PROFIBUS copper cables. The system comprises compatible components:

- FastConnect Standard Cable for fast assembly
- FastConnect Stripping Tool With FastConnect Blade Cassettes (spare blade cassettes for the stripping tool)
- FastConnect bus connector for PROFIBUS

Repeater for PROFIBUS

A repeater links the individual bus segments with RS 485 technology. Main applications are:

- Increase in number of nodes and distances
- Electrical isolation of segments

If diagnostics functions for physical cable diagnostics are desired in addition to the standard repeater functionality, a diagnostics repeater can be used as an alternative. It monitors the copper bus cables in online mode. In the event of a fault it sends a diagnostic message with detailed information about the type and location of the fault to the DP master.

Active RS 485 terminating element

The active RS 485 terminating element is used to terminate bus segments. The component supplied with 24 V DC independent of the bus nodes provides a defined RS 485 signal level, and suppresses reflections on the line. Bus nodes (e.g. ET 200S) can be coupled and decoupled without feedback to/from PROFIBUS networks terminated by active RS 485 terminating elements.

SIMATIC PCS 7 system hardware

Industrial communication

PROFIBUS

PROFIBUS DP > Electrical networks**Design** (continued)**RS 485-IS Coupler**

The RS 485-iS coupler is an isolating transformer with which the PROFIBUS DP fieldbus can be routed intrinsically-safe into the hazardous area.

The RS 485-iS coupler has the following functions:

- Connection of intrinsically-safe PROFIBUS DP nodes, e.g. ET 200iSP or devices from other vendors with Ex i DP connection
- Conversion of the electrical PROFIBUS DP RS 485 transmission system into the intrinsically-safe RS 485-iS transmission system with a transmission rate of 1.5 Mbps
- Suitable as a safety barrier
- Additional use as a repeater in hazardous areas

The RS 485-iS coupler as an open resource can only be used in housings, cabinets or rooms for electrical equipment.

It is assembled on a SIMATIC S7-300 mounting rail which can be positioned horizontally or vertically.

The RS 485iS coupler is integrated into the PROFIBUS as follows:

- Connection to standard PROFIBUS DP via standard Sub-D socket (at the bottom on the RS 485-iS coupler, behind the right front door).
- Connection of PROFIBUS DP with RS 485-iS transmission system via screw terminals (at the top of the RS 485-iS coupler, behind the right front door)
- The last bus node on the intrinsically safe PROFIBUS DP segment (not further RS 485-iS couplers) must be terminated by a selectable terminating resistor using the connector, article number 6ES7972-0DA60-0XA0.

Ordering data

Ordering data	Article No.	Article No.
PROFIBUS FastConnect Standard Cable, violet Standard type with special design for fast mounting, 2-wire, shielded, cut-to-length Specify length in m Max. delivery unit 1 000 m, minimum order quantity 20 m <u>Preferred lengths</u> - 20 m - 50 m - 100 m - 200 m - 500 m - 1 000 m	6XV1830-0EH10	RS 485 Repeater for PROFIBUS Data transfer rate max. 12 Mbps 24 V DC, IP20 enclosure
PROFIBUS FastConnect Standard Cable IS GP, blue Cable type for use in potentially explosive atmospheres, with special design for fast mounting, 2-wire, shielded, cut-to-length Specify length in m Max. delivery unit 1 000 m, minimum order quantity 20 m Further PROFIBUS cables with associated specifications	6XV1830-0EN20 6XV1830-0EN50 6XV1830-0ET10 6XV1830-0ET20 6XV1830-0ET50 6XV1830-0EU10	RS 485 Diagnostic Repeater For connection of up to 2 segments to PROFIBUS DP; with online diagnostics functions for monitoring the bus lines
PROFIBUS FastConnect Stripping Tool Pre-adjusted tool for fast stripping of PROFIBUS FastConnect bus cables	6XV1831-2A See Catalog IK PI	Active RS 485 terminating element for PROFIBUS For terminating bus segments for data transfer rates from 9.6 Kbps to 12 Mbps
PROFIBUS FastConnect Blade Cassettes Spare blade cassettes for PROFIBUS FastConnect stripping tool, 5 units	6GK1905-6AA00	RS 485-IS Coupler Isolating transformer for connection of PROFIBUS DP segments with RS 485 and RS 485-iS transmission technologies Operating temperature -40 to +70 °C
PROFIBUS FastConnect bus connector RS 485 with 90° cable outlet With insulation displacement 15.8 × 59 × 35.6 mm (W × H × D) Max. data transfer rate 12 Mbps • No programming port • With programming port	6GK1905-6AB00	PROFIBUS connector with selectable terminating resistor For connection of IM 152 to PROFIBUS DP with RS 485-iS transmission technology
PROFIBUS FastConnect bus connector RS 485 Plug 180 With 180° cable outlet, with insulation displacement system, for connection of PC, PG, OP Other bus connectors See Catalog IK PI	6GK1500-0FC10	S7-300 mounting rails Lengths: • 160 mm • 482 mm • 530 mm • 830 mm • 2 000 mm
		6ES7972-0AA02-0XA0 6ES7972-0AB01-0XA0 6ES7972-0DA00-0AA0 6ES7972-0AC80-0XA0 6ES7972-0DA60-0XA0 6ES7390-1AB60-0AA0 6ES7390-1AE80-0AA0 6ES7390-1AF30-0AA0 6ES7390-1AJ30-0AA0 6ES7390-1BC00-0AA0

Note:

For more information on electrical PROFIBUS networks as well as components and accessories, particularly cable material for special applications, refer to Catalog IK PI, "PROFIBUS" chapter, section "Network components for PROFIBUS – electrical networks".

Overview

Optical networks are more expensive than electrical RS 485 networks, but are insensitive to electromagnetic interference. In addition to purely optical networks, the combination of electrical and optical networks has been established in practice, providing users with the advantages of the respective transmission technologies.

Design

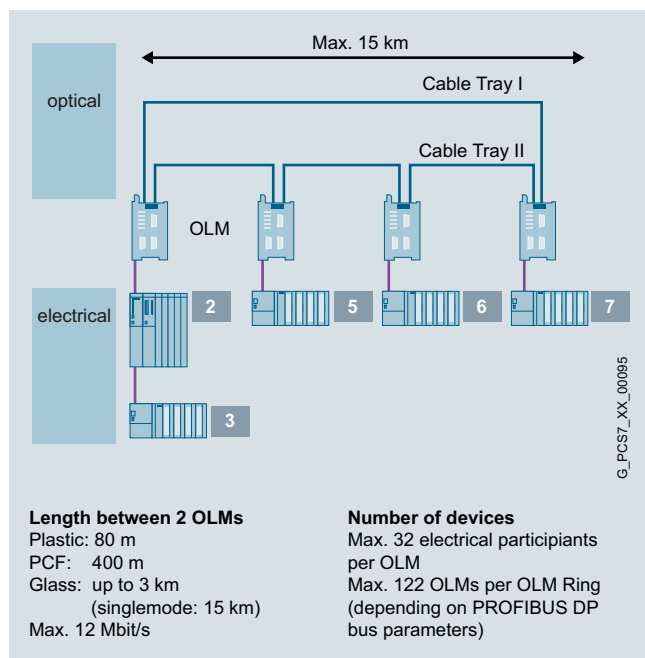

Configuration example of an optical ring combined with an electrical network

A fault-tolerant ring structure of the optical network prevents communication losses if the cable is damaged or disconnected at any point. Electrical bus segments are incorporated into the optical ring using up to 122 optical link modules (OLMs). Depending on the OLM and bus cable version, the distance between two OLMs can be up to 15 km. A maximum of 32 electrical bus nodes can be operated on one OLM.

The configuration example shows a typical addressing scheme with mixed transmission technologies. Although OLMs are electrical nodes within their respective segment, they are not assigned a PROFIBUS slave address.



Optical Link Module OLM/G22

Optical link modules

Optical link modules (OLM) permit the construction of optical and hybrid (electrical/optical) networks in line, ring or star topologies.

OLMs can be combined with each other, and individual nodes or complete electrical segments can be integrated into the optical PROFIBUS network through an electrical interface.

OLMs are available with one (P11/G11) or two (P12/G12/G22) fiber-optic (FO) interfaces with BFOC connections. Depending on the version, they are suitable for the following distances when combined with the correspondingly specified plastic/glass fiber-optic cables:

Distance	Fiber-optic cable	OLM
Up to 80 m	POF-FOC	OLM/P11 or OLM/P12
Up to 400 m	PCF FOC	
Up to 3 km	Glass multimode FO	Depending on ambient temperature • 0 to +60 °C: OLM/G11, OLM/G12 or OLM/G22 • -25 to +60 °C: OLM/G12-EEC
Up to 10 km	Glass multimode FO	OLM/G11-1300 or OLM/G12-1300
Up to 15 km	Glass single-mode FO	

We recommend the OLM/G12 as the standard component for optical PROFIBUS networks both indoors and outdoors.

The OLMs have a compact metal housing suitable for DIN mounting rail assembly. They automatically recognize all PROFIBUS data transfer rates. Faults can be rapidly located as follows:

- Display of module status via floating signaling contact
- Checking of FO link quality (loss per section) via test output for optical receivers for logging and plausibility checks

Additional information and detailed technical specifications on the various OLM versions can be found in Catalog IK PI, chapter "PROFIBUS", section "Network components for PROFIBUS - Optical networks with OLM".

Bus cables

Suitable for the OLM/G12, fiber-optic cables (FOC) made of glass with 2 multimode fibers are preferred for optical PROFIBUS networks both indoors and outdoors.

The standard FIBER OPTIC CABLE is available in fixed lengths up to 2 000 m. It is pre-assembled with 4 BFOC connectors. A BFOC connector set with 20 connectors is available as an accessory.

Further fiber-optic cables as well as detailed technical specifications can be found in the IK PI Catalog, chapter "PROFIBUS", section "Network components for PROFIBUS - Optical networks".

SIMATIC PCS 7 system hardware

Industrial communication

PROFIBUS

PROFIBUS DP > Optical networks

Ordering data	Article No.	Article No.	
FIBER OPTIC CABLE Standard glass FO cable, splittable Pre-assembled with 4 BFOC connectors Preferred lengths <ul style="list-style-type: none"> • 1 m • 5 m • 10 m • 20 m • 50 m • 100 m Other lengths and cables	6XV1820-5BH10 6XV1820-5BH50 6XV1820-5BN10 6XV1820-5BN20 6XV1820-5BN50 6XV1820-5BT10 See Catalog IK PI	PROFIBUS OLM/G22 V4.0 Optical Link Module with two RS 485 ports and two glass FOC ports (4 BFOC sockets), for standard distances up to 3 km, with signaling contact and measuring output	6GK1503-4CB00
BFOC Connector Set¹⁾ For standard and trailing FIBER OPTIC CABLES, 20 units	6GK1901-0DA20-0AA0	PROFIBUS OLM/G12-EEC V4.0 Optical Link Module with one RS 485 port and two glass FOC ports (4 BFOC sockets), for standard distances up to 3 km, suitable for extended temperature range from -25 to +60 °C, with signaling contact and measuring output	6GK1503-3CD00
PROFIBUS OLM/P11 V4.1 Optical Link Module with one RS 485 port and one plastic FOC port (2 BFOC sockets), with signaling contact and measuring output	6GK1503-2CA01	PROFIBUS OLM/G11-1300 V4.0 Optical Link Module with one RS 485 port and one glass FOC port (2 BFOC sockets), 1 300 nm wavelength for long distances up to 15 km, with signaling contact and measuring output	6GK1503-2CC00
PROFIBUS OLM/P12 V4.1 Optical Link Module with one RS 485 port and two plastic FOC ports (4 BFOC sockets), with signaling contact and measuring output	6GK1503-3CA01	PROFIBUS OLM/G12-1300 V4.0 Optical Link Module with one RS 485 port and two glass FOC ports (4 BFOC sockets), 1 300 nm wavelength for long distances up to 15 km, with signaling contact and measuring output	6GK1503-3CC00
PROFIBUS OLM/G11 V4.0 Optical Link Module with one RS 485 and one glass FOC interface (2 BFOC sockets), for standard distances up to 3 000 m, with signaling contact and measuring output	6GK1503-2CB00		
PROFIBUS OLM/G12 V4.0 Optical Link Module with one RS 485 port and two glass FOC ports (4 BFOC sockets), for standard distances up to 3 km, with signaling contact and measuring output	6GK1503-3CB00		

¹⁾ You can order supplementary components for the SIMATIC NET cabling range from your local contact. Technical support on this subject is available from:
 Siemens AG,
 SPG Industrial Network and Components,
 Fürth J. Hertlein
 Tel.: +49 911 750-4465
 E-mail: juergen.hertlein@siemens.com

Overview



In a SIMATIC PCS 7 automation system, PROFIBUS DP lines can be connected to distributed process I/O both via a PROFIBUS DP interface in the CPU and via a CP 443-5 Extended communications module.

If a module slot provided in the CPU for the PROFIBUS connection is still empty, an IF 964-DP interface module is required in addition.

With the AS 410 modular automation systems, an additional layer is applied to the PCB of CPU 410-5H Process Automation (conformal coating). To match the AS 410, a CP 443-5 Extended in the conformal coating version is therefore preferred (component of the AS bundle configuration).

For information on the type and number of configurable PROFIBUS DP interfaces, see chapter "Automation systems".

Ordering data

Article No.

SIMATIC NET CP 443-5 Extended

Communications module for connection of SIMATIC S7-400 to PROFIBUS as DP master or for S7 communication, for increasing the number of DP lines, for data set routing with SIMATIC PDM and for 10-ms time stamping, electronic manual on CD; module occupies 1 slot

6GK7443-5DX05-0XE0

IF 964-DP

Interface module for connection of another PROFIBUS DP line, for plugging into a free DP module slot of the CPU

6ES7964-2AA04-0AB0

Benefits

Advantages of the CP 443-5 Extended communications module:

- Compact design; 9-pin Sub-D socket for connection to PROFIBUS DP
- Simple installation
Can be plugged into AS rack slot; connection to the other S7-400 modules via backplane bus
- Operation without fan; backup battery or memory submodule are not required
- With additional PBC coating option (conformal coating)

SIMATIC PCS 7 system hardware

Industrial communication
PROFIBUS

PROFIBUS DP > Y-Link

Overview



The Y-Link is a bus coupler for transition from a redundant PROFIBUS DP master system to a simple, single-channel PROFIBUS DP master system. It can be used to connect devices with only one PROFIBUS DP interface to the redundant PROFIBUS DP master system.

Ordering data

Article No.

Y-Link

For connection of devices with only one PROFIBUS DP interface to a redundant automation system, comprising:

- 2 IM 153-2 High Feature Outdoor interface modules
- 1 Y-coupler
- 1 BM IM/IM bus module
- 1 BM Y-coupler bus module

6ES7197-1LA12-0XA0

PS 307 load current supply

Including connecting comb;
120/230 V AC; 24 V DC

- 2 A; 40 mm wide
- 5 A; 60 mm wide
- 5 A, extended temperature range; 80 mm wide
- 10 A, 80 mm wide

6ES7307-1BA01-0AA0

6ES7307-1EA01-0AA0

6ES7307-1EA80-0AA0

6ES7307-1KA02-0AA0

PS 305 Load Power Supply

24/48/60/110 V DC; 24 V DC

- 2 A, extended temperature range; 80 mm wide

6ES7305-1BA80-0AA0

Design

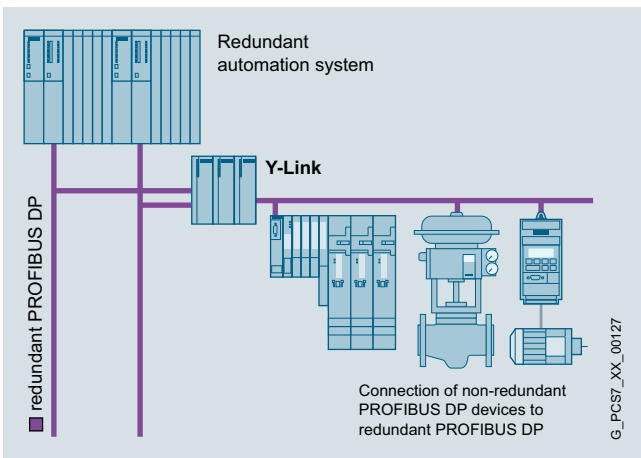

The Y-link comprises:

- 2 IM 153-2 High Feature Outdoor interface modules
- 1 Y-coupler including RS 485 repeater
- 1 BM IM/IM bus module for 2 IM 153-2 High Feature Outdoor modules
- 1 BM Y-coupler bus module

Evaluation of the Y-link diagnostics (and hence indirectly of the connected DP standard slaves) is supported by driver blocks.

It is recommendable to have a redundant -24 V DC supply for the Y-link, e.g. with two PS 307/PS 305 load power supplies.

Overview

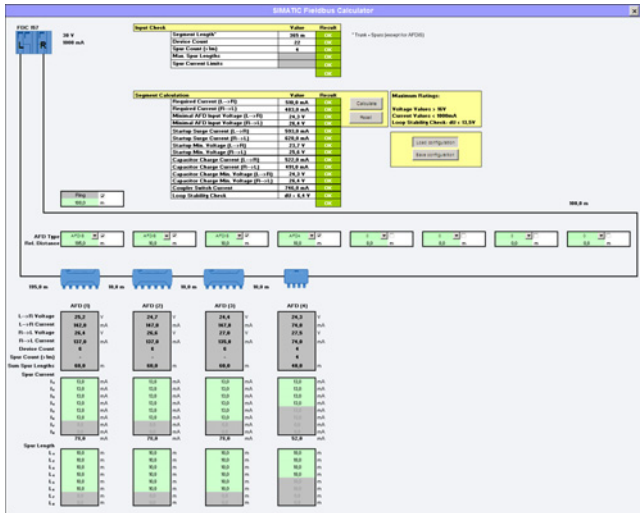

SIMATIC Fieldbus Calculator

Direct interfacing of the devices in the field, especially in the hazardous area, together with the information content of the communication, are of significant importance in the process industry. PROFIBUS PA, which permits both digital data transmission and the power supply on a two-wire cable with the intrinsically-safe MBP transmission system (Manchester Coded; Bus Powered) is tailored to these requirements. It is optimally suitable for direct integration of solenoid valves, sensors, and pneumatic actuators positioned in operating environments up to Ex Zone 1/21 or 0/20 into the process control system.

The typical response time of a transmitter of approx. 10 ms indicates that short cycle times can be achieved with the PROFIBUS PA even in the case of a segment configuration with up to 31 devices. Practically all typical applications of the process industry can be implemented, both in small and large plants. Bidirectional communication and high information content allow enhanced diagnostics for fast and exact fault detection and elimination. The standardized communications services guarantee interoperability and replaceability between multi-vendor field devices and remote configuration of the field devices during operation.

Safety communication with the PROFIsafe profile

The PROFIsafe profile allows seamless integration of safety communication into the PROFIBUS PA. You need not configure a separate safety bus for your safety-related applications. The PROFIBUS PA with the PROFIsafe profile is incorporated in "Safety Integrated for Process Automation". This comprehensive range of products and services from Siemens for fail-safe, fault-tolerant applications in the process industry offers you attractive and cost-effective alternatives to separate safety systems.

Redundant architectures

You can define the degree of redundancy separately for the controller, fieldbus and I/O levels of your plant depending on the automation task and the derived safety requirements, and match them to the field instrumentation (flexible modular redundancy, FMR). You can find an overview of the redundant architectures of PROFIBUS PA under "Design".

Network transition PROFIBUS PA to PROFIBUS DP

The PA link is preferred as the network transition from PROFIBUS PA to PROFIBUS DP. When using the PA link, the transmission rate on the PROFIBUS DP is independent of the lower-level PROFIBUS PA segments. The configuration of the PA link depends on the fieldbus architecture. The types of coupler described in the section "PA gateways" can be used for the configuration. With a small amount of data (small quantity framework) and low timing requirements, the DP/PA coupler can also be operated in stand-alone mode as a gateway.

Benefits

The advantages of distributed field automation and the use of the PROFIBUS PA profile include low hardware overheads, cost-effective engineering, increased operational safety and problem-free maintenance. These advantages are underlined by the following features:

- Modularity and uniformity from the sensor up to the control level enable new plant designs
- Implementation of intrinsically-safe applications through use of the fieldbus in hazardous areas
- Redundant PROFIBUS PA architectures (ring and line topologies with coupler redundancy) support Flexible Modular Redundancy (FMR) from the automation system (controller) down to a PA field device
- Safety-related and fault-tolerant applications with low device and cabling requirements
- Reduced configuration costs through simple, central engineering of the field devices (PROFIBUS PA and HART with SIMATIC PDM, also cross-vendor)
- Simple installation using two-wire cable for common power supply and data transmission
- Reduced commissioning costs through simplified loop check
- Low servicing costs thanks to simple wiring and comprehensive diagnostics capabilities

SIMATIC PCS 7 system hardware

Industrial communication
PROFIBUS

PROFIBUS PA

Design

Examples of PROFIBUS PA architectures

The following graphical representations illustrate possible PROFIBUS PA configuration variants with DP/PA coupler and PA Link routers on the:

- PROFIBUS DP master, simple design (AS Single Station)
- PROFIBUS DP master, redundant design (AS Redundancy Station)

If the DP/PA coupler is operated independently as a PA gateway, then the PROFIBUS DP connection is directly on the coupler instead of via the interface module.

The number of PROFIBUS PA devices is limited according to the specifications in the "Technical specifications" section.

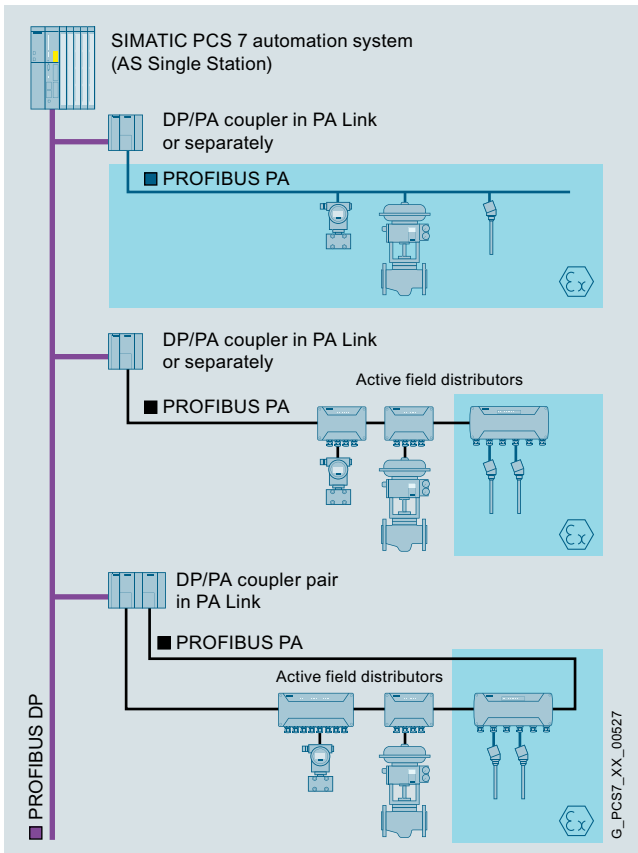

PROFIBUS PA on an AS Single Station as PROFIBUS DP master

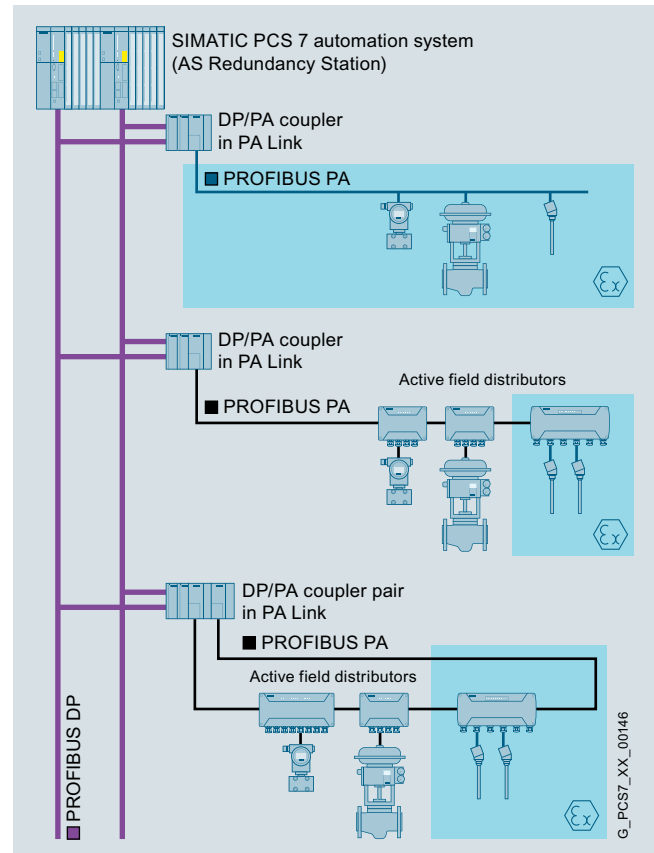

PROFIBUS PA on an AS Redundancy Station as PROFIBUS DP master

Benefits (continued)

Line architecture with single coupler

In the line architecture with individual couplers, each line segment is connected to one DP/PA coupler each.

If the PA gateway is an independent DP/PA coupler, then a PROFIBUS PA line (line segment) can be connected. A maximum of 5 line segments can be operated via single couplers (max. 3 for mixed configurations with ring or coupler redundancy) on a PA link as PA gateway, equipped with up to 5 DP/PA couplers.

The PA gateway can be connected to a single or redundant PROFIBUS DP, depending on the version (see figures).

The FDC 157-0 is the first choice as the DP/PA coupler. When using this coupler, the PA-devices can be integrated into the line segment via AFD active field distributors, e.g. AFD4, AFD4 RAILMOUNT, AFD4 FM and AFD8 (approval for Ex Zone 2/22) and AFDiSD (approval for Ex Zone 1/21). The PA devices are connected to these field distributors via short-circuit-proof spur lines.

Alternatively, it is possible to operate up to 8 AFD field distributors, up to 5 AFDiSD field distributors or any combination of up to 5 AFDiSD and AFD field distributors in a line segment. With mixed AFDiSD/AFD operation, however, extended fieldbus diagnostics of the AFDiSD in the PROFIBUS PA is not possible. The last field distributor at the end of the line leading away from the DP/PA coupler automatically activates its bus terminating resistor.

Intrinsically-safe PA devices in hazardous areas in accordance with Ex Zone 1/21 or 0/20 are preferably integrated into a bus segment by means of AFDiSD active field distributors. For PA devices in Ex Zone 1/21, connection via a line segment on the DP/PA coupler Ex [i] (in the PA Link or independently) is a possible alternative. The devices are integrated separately into the line segment using SplitConnect taps (via spur line or directly via SplitConnect M12 outlet). A SplitConnect terminator is required for the bus termination of the segment.

By grouping individual devices in different line segments, flexible modular redundancy is possible at device level.

Ring architecture with coupler and media redundancy

With the redundant DP/PA coupler pair (2 × FDC 157-0) of a PA gateway, a ring segment with automatic bus termination can also be implemented. Apart from the ring segment, only line segments with individual couplers can be configured on this PA gateway. The PA gateway can be connected to a single or a redundant PROFIBUS DP.

Integration of the PA field devices into the ring segment is carried out via active AFD or AFDiSD field distributors whose number is limited as with the line architectures (up to 8 AFD, up to 5 AFDiSD or up to 5 AFDiSD and AFD combined; for mixed AFDiSD and AFD operation, extended fieldbus diagnostics for the AFDiSD is not possible). These field distributors have galvanically isolated, short-circuit-proof spur line connections for connecting the PA devices.

At the device level, flexible modular redundancy is possible by grouping individual devices on different field distributors.

Special advantages of the ring architecture:

- High availability
- Transparent redundancy management of intelligent DP/PA couplers FDC 157-0 for the host system
- Active bus terminators for automatic bus termination in the FDC 157-0 DP/PA couplers and the AFD and AFDiSD active field distributors enable:
 - Automatic, smooth isolation of faulty subsegments in the event of a short-circuit or wire break
 - Modification of the ring configuration or instrumentation during operation, including the addition or removal of ring segments
- Safety-related and fault-tolerant applications with low device and cabling requirements

SIMATIC PCS 7 system hardware

Industrial communication

PROFIBUS

PROFIBUS PA

Design (continued)

Cable lengths of bus segments and spur lines

The PROFIBUS PA is based on electrical transmission components. A shielded two-wire cable is used for digital data transmission and for the power supply of the field devices.

With line, tree and ring topologies, bus segments up to approx. 1.9 km can be configured. If AFD active field distributors are used, both the length of the spur lines for connecting devices and the quality of the cable used must also be considered when calculating the total length of the bus segment. Spur lines on the AFDiSD are not relevant to the total length of the bus segment.

For bus segments with active field distributors, the spur lines can have the following maximum lengths:

- Up to 120 m in accordance with IEC 61158-2
- Up to 120 m in accordance with IEC 60079-27 (FISCO)

With AFD active field distributors, these maximum values may be reduced depending on the number of spur lines of the bus segment (for details, see the "Technical specifications" section). With AFDiSD active field distributors, this reduction is canceled by the integrated repeater function.

The **SIMATIC Fieldbus Calculator** provides help in calculating and designing fieldbus segments:

<https://support.industry.siemens.com/cs/ww/en/view/53842953>

Intrinsically-safe PA devices in hazardous areas are preferably integrated into a bus segment by means of AFDiSD active field distributors. For PA devices in Ex zone 1/21, connection via a line segment on the PA gateway with DP/PA coupler Ex [i] is a possible alternative. In such a configuration the max. possible length per spur line is reduced to 30 m and per bus segment to 1 km.

Bus segments are terminated either automatically (for architectures with AFD or AFDiSD active field distributors) or with the passive terminating element for PROFIBUS PA (SplitConnect terminator).

Technical specifications

PROFIBUS PA

Data transmission	MBP
Transmission rate	31.25 Kbps
Cable	2-wire shielded
Type of protection	EEx(ia/ib)
Topology	Line, tree, ring
Active field distributors per segment/coupler	
• AFD	8
• AFDiSD or combinations of AFDiSD and AFD	5
PA devices per segment/coupler	31
PA devices per PA link	64
Max. current for all PA field devices of a segment (for PA gateways with FDC 157-0 coupler)	1 A
Cable length per segment	
• Standard	1 900 m
• EEx(ib)	1 900 m
• EEx(ia)	1 000 m

Bus segments with AFD

Max. spur line length in relation to the total number of spur lines

Number of spur lines (1 device per spur line)	
• 1 to 12 spur lines	120 m
• 13 to 14 spur lines	90 m
• 15 to 18 spur lines	60 m
• 19 to 24 spur lines	30 m
• 25 to 31 spur lines	1 m

Bus segments with AFDiSD

Max. spur line length independent of total number of spur lines

Number of spur lines (1 device per spur line)	
• 1 to 31 spur lines	
- Not intrinsically-safe	120 m
- Intrinsically-safe acc. to FISCO	120 m

Overview



PA link, consisting here of IM 153-2 High Feature Outdoor and DP/PA coupler

To create a smooth network transition between PROFIBUS DP and PROFIBUS PA, the SIMATIC product range offers two versions: the DP/PA coupler and the PA link.

The following criteria can be applied when choosing the network transition:

- DP/PA coupler:
For small quantity frameworks (volumes of data) and low timing requirements; data transfer rate on the PROFIBUS DP limited to 45.45 Kbps
- PA link:
For large number of nodes and high cycle time requirements; data transfer rate on the PROFIBUS DP up to 12 Mbps

Application

The two PA gateways are based on two versions of the DP/PA coupler:

- Ex [i] DP/PA coupler (max. output current 110 mA)
For implementation of PROFIBUS PA networks with a line or tree topology in environments up to Ex Zone 1/21; not for redundant architectures (coupler redundancy, ring)
- DP/PA coupler FDC 157-0 (max. output current 1 000 mA)
For implementation of PROFIBUS PA networks with a line, tree or ring topology in environments up to Ex Zone 2/22; can be used for the "Ring" and "Line with coupler redundancy" redundant architectures.

DP/PA couplers are also integral components of the PA link (see design). The PA link connects PROFIBUS DP and PROFIBUS PA together, and decouples the transmission rates. In contrast to the DP/PA coupler gateway which limits the data transmission rate on the PROFIBUS DP to 45.45 Kbps, the PA link does not influence the performance of the PROFIBUS DP.

The PA link functions as a slave on the PROFIBUS DP and as a master on the PROFIBUS PA. From the viewpoint of the host PROFIBUS DP master, the PA link is a modular slave whose modules are the devices connected on the PROFIBUS PA. Addressing of these devices is carried out indirectly via the PA link that itself only requires one node address. The host PROFIBUS master can scan devices connected to the PA link all at once.

If the gateway is a DP/PA coupler, the nodes on the PROFIBUS PA are directly addressed by the PROFIBUS DP master (controller). The DP/PA coupler is an electrical node, but is transparent for communication between the master and PA field devices; it therefore does not require setting of parameters or addresses (exception: FDC 157-0 DP/PA coupler used as PROFIBUS diagnostics slave).

PROFIBUS diagnostics with FDC 157-0 DP/PA coupler, configured as PROFIBUS diagnostics slave

FDC 157-0 DP/PA couplers configured as PROFIBUS diagnostics slaves supply extensive diagnostic and status information via PROFIBUS for swift localization and correction of faults:

- I&M (identification & maintenance) data
- Current and voltage values on the main line
- Redundancy status
- Wire break
- Short-circuit
- Signal level

To this end, each of these DP/PA couplers FDC 157-0 requires its own PROFIBUS address. This applies independent of use in a PA link or as a PA gateway.

The PA link and DP/PA coupler are available for use in operating environments up to Ex Zone 2/22. Both are operated with 24 V DC. Assembly is on an S7-300 mounting rail with horizontal or vertical alignment.

SIMATIC PCS 7 system hardware

Industrial communication
PROFIBUS

PROFIBUS PA > PA network transition

Design

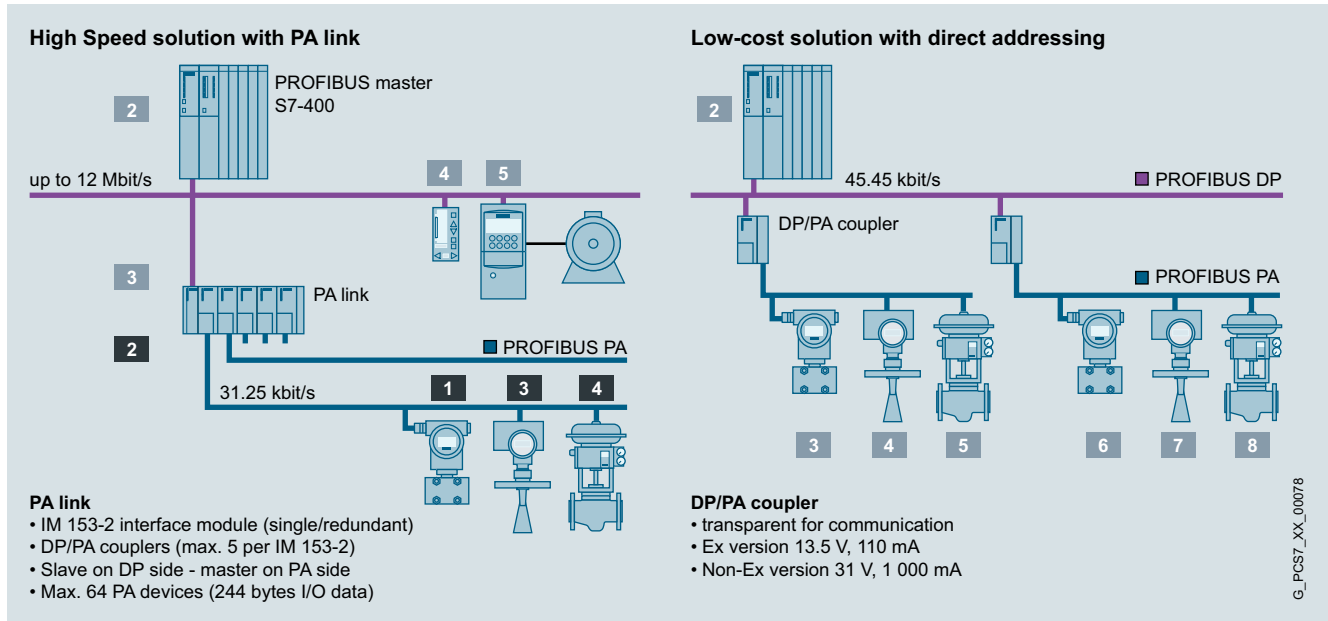

Configuration examples for PA link and DP/PA coupler

PA link

The PA link is a modular combination in S7-300 design consisting of the IM 153-2 High Feature Outdoor PROFIBUS DP interface module (with optional redundancy) and up to 5 DP/PA couplers (FDC 157-0 or Ex [i]).

All components of the PA link are interconnected through the S7 backplane bus. Use of active bus modules on the backplane allows hot swapping of individual modules and redundancy of the IM 153-2 High Feature Outdoor PROFIBUS DP interface modules and the FDC 157-0 DP/PA couplers. If redundancy and changes during operation are not required, passive bus connectors can be used instead of active bus modules.

The PS 307 or PS 305 load power supply can be used for the 24 V DC. With a redundant IM 153-2 High Feature Outdoor PROFIBUS DP interface module, a redundant 24 V DC supply is also recommended, e.g. using two PS 307/PS 305 load current supplies.

The PROFIBUS PA bus segments designed with the DP/PA couplers are physically separated as regards current infeed, but form one bus system in communication terms. A PROFIBUS PA ring segment or a PROFIBUS PA line segment with coupler redundancy can be operated on a PA link. Further PROFIBUS PA line segments can be operated on this PA link using individual couplers. The FDC 157-0 DP/PA couplers provided for the ring coupling or coupler redundancy must always be located at the right-hand end of a sequence of up to 5 couplers.

The following basic components are available for configuring the PA link:

- IM 153-2 High Feature Outdoor interface
- DP/PA coupler (Ex [i] and FDC 157-0)
- Components for redundant design and for hot swapping:
 - Mounting rail for hot swapping (as an alternative to the standard mounting rail)
 - BM PS/IM for 1 load power supply and 1 IM 153-2 High Feature Outdoor module
 - BM IM/IM for 2 IM 153-2 High Feature Outdoor modules, for redundant and non-redundant configuration
 - BM FDC for 1 DP/PA coupler Ex [i] or FDC 157-0 (up to 5 DP/PA couplers possible per PA link)
 - BM FDC/FDC for 2 DP/PA couplers FDC 157-0

Additive options:

- PS 307 for 120/230 V AC; 24 V DC load power supply, version in 2, 5 or 10 A, or
- PS 305 load power supply for 24/48/60/110 V DC; 24 V DC, 2 A

Ordering data	Article No.	Article No.	
DP/PA coupler For transition from RS 485 to MBP			
<ul style="list-style-type: none"> DP/PA coupler Ex [i] Fieldbus coupler between PROFIBUS DP and PROFIBUS PA, EEx(ia) version, max. output current 110 mA; degree of protection IP20; permissible operating temperature 25 to +60 °C 	6ES7157-0AD82-0XA0		
<ul style="list-style-type: none"> DP/PA coupler FDC 157-0 Fieldbus coupler between PROFIBUS DP and PROFIBUS PA, redundancy capable; integrated PROFIBUS diagnostics slave; max. output current 1 A; IP20 degree of protection; permissible operating temperature -25 to +60 °C 	6ES7157-0AC85-0XA0		
IM 153-2 High Feature Outdoor Interface module for PROFIBUS DP for ET 200M, PA link and Y link; redundancy capable; conformal coating, IP20 degree of protection; permissible operating temperature -25 to +60 °C	6ES7153-2BA70-0XB0		
Accessories			
PS 307 load current supply Including connecting comb; 120/230 V AC; 24 V DC			
<ul style="list-style-type: none"> 2 A; 40 mm wide 	6ES7307-1BA01-0AA0		
<ul style="list-style-type: none"> 5 A; 60 mm wide 	6ES7307-1EA01-0AA0		
<ul style="list-style-type: none"> 5 A, extended temperature range; 80 mm wide 	6ES7307-1EA80-0AA0		
<ul style="list-style-type: none"> 10 A, 80 mm wide 	6ES7307-1KA02-0AA0		
PS 305 Load Power Supply 24/48/60/110 V DC; 24 V DC			
<ul style="list-style-type: none"> 2 A, extended temperature range; 80 mm wide 	6ES7305-1BA80-0AA0		
Standard mounting rails (without hot swapping function)			
<ul style="list-style-type: none"> Width 482 mm (19") 	6ES7390-1AE80-0AA0		
<ul style="list-style-type: none"> Width 530 mm 	6ES7390-1AF30-0AA0		
		Components for hot swap and for redundant configuration	
		Active bus modules for hot swapping	
		<ul style="list-style-type: none"> BM PS/IM SIPLUS extreme For 1 load current supply and 1 IM 153-2 High Feature module; for hot swap function, permissible operating temperature -25 to +70 °C 	6AG1195-7HA00-2XA0
		<ul style="list-style-type: none"> BM IM/IM For 2 IM 153-2 High Feature modules, for redundant and non-redundant configuration, for hot swap function, permissible operating temperature -25 to +60 °C 	6ES7195-7HD80-0XA0
		<ul style="list-style-type: none"> BM FDC For 1 DP/PA coupler Ex [i] or FDC 157-0, for hot swap function, permissible operating temperature -25 to +60 °C 	6ES7195-7HF80-0XA0
		<ul style="list-style-type: none"> BM FDC/FDC For 2 DP/PA couplers FDC 157-0, for hot swap function, permissible operating temperature -25 to +60 °C 	6ES7195-7HG80-0XA0
		Mounting rail for hot swapping For max. 5 active bus modules	
		<ul style="list-style-type: none"> Width 482 mm (19") 	6ES7195-1GA00-0XA0
		<ul style="list-style-type: none"> Width 530 mm 	6ES7195-1GF30-0XA0
		<ul style="list-style-type: none"> Width 620 mm 	6ES7195-1GG30-0XA0
		Covers 4 backplane bus covers and 1 cover for active bus module	6ES7195-1JA00-0XA0
		Bundles	
		I/O subsystem for PA link or ET 200M For PA Link or for ET 200M stations with up to 8 I/O modules, suitable for hot swapping, consisting of:	6ES7654-0XX10-1XA0
		<ul style="list-style-type: none"> Mounting rail for active bus modules, 482 mm long (19 inches) PS/IM bus module PROFIBUS DP interface IM 153-2 High Feature Outdoor 	
		I/O subsystem extended for PA link or ET 200M For PA Link or for ET 200M stations with up to 12 I/O modules, suitable for hot swapping, consisting of:	6ES7654-0XX10-1XB0
		<ul style="list-style-type: none"> Mounting rail for active bus modules, 620 mm long PS/IM bus module PROFIBUS DP interface IM 153-2 High Feature Outdoor 	
		RED I/O subsystem for PA Link or ET 200M For operation of a PA Link or an ET 200M station on a redundant automation system of the S7-400 series, suitable for hot swapping, consisting of:	6ES7654-0XX20-0XA0
		<ul style="list-style-type: none"> 2 PROFIBUS DP interfaces IM 153-2 High Feature Outdoor 1 active bus module IM/IM Outdoor 	

SIMATIC PCS 7 system hardware

Industrial communication PROFIBUS

PROFIBUS PA > PA network transition

Technical specifications

DP/PA Coupler	
Bus connection	
Connection for PROFIBUS PA	2 terminals of a 4-pin screw-type terminal, integrated terminating resistor
<ul style="list-style-type: none"> DP/PA coupler Ex [i] DP/PA coupler FDC 157-0 	
Connection for PROFIBUS DP	4-pin screw-type terminal for connection and looping through, selectable terminating resistor
	9-pin D-sub connector Contact assignment as described in IEC 61158/EN 50170
Module-specific data	
Degree of protection	IP20
Transmission rate	
<ul style="list-style-type: none"> On PROFIBUS DP On PROFIBUS PA 	45.45 Kbps 31.25 Kbps
Communication protocol	PROFIBUS DP
Voltages, currents, potentials	
Supply voltage	24 V DC (20.4 ... 28.8 V)
Reverse polarity protection	Yes
Overvoltage protection	Yes
Voltage at coupler output (PA)	
<ul style="list-style-type: none"> DP/PA coupler Ex [i] DP/PA coupler FDC 157-0 	13 ... 14 V DC 31 ± 1 V DC
Voltage monitoring	15.5 V
Overvoltage monitoring	U > 35 V; latching cutoff
Voltage failure bridging	Min. 5 ms
Current at coupler output (PA) for supplying the PA field devices	
<ul style="list-style-type: none"> DP/PA coupler Ex [i] DP/PA coupler FDC 157-0 	Max. 110 mA Max. 1 A
Galvanic isolation 24 V DC	
<ul style="list-style-type: none"> PROFIBUS DP/PROFIBUS PA PROFIBUS DP/supply PROFIBUS PA/supply All electric circuits/functional grounding 	Yes Yes Yes Yes
Power consumption of modules (24 V DC)	
<ul style="list-style-type: none"> DP/PA coupler Ex [i] DP/PA coupler FDC 157-0 	Max. 400 mA Max. 2.3 A
Module power loss	
<ul style="list-style-type: none"> DP/PA coupler Ex [i] DP/PA coupler FDC 157-0 	Typ. 7 W Typ. 13.4 W
Status, interrupts, diagnostics	
Diagnostics displays DP/PA coupler Ex [i] and DP/PA coupler FDC 157-0	
<ul style="list-style-type: none"> PROFIBUS DP bus monitoring PROFIBUS PA bus monitoring 24 V DC power supply monitoring 	Yellow "DP" LED Yellow "PA" LED Green "ON" LED
Additive diagnostics displays of the DP/PA coupler FDC 157-0	
<ul style="list-style-type: none"> Group error Bus error Monitoring DP/PA coupler (active coupler in redundant configuration) 	Red LED "SF" Red LED "BF" Yellow "ACT" LED
Climatic conditions	
Permissible operating temperature DP/PA coupler Ex [i] and DP/PA coupler FDC 157-0	
<ul style="list-style-type: none"> Horizontal installation Vertical installation 	-25 to +60 °C -25 to +40 °C
Dimensions and weight	
Dimensions (W × H × D) in mm	80 × 125 × 130
Weight	
<ul style="list-style-type: none"> DP/PA coupler Ex [i] DP/PA coupler FDC 157-0 	Approx. 550 g Approx. 515 g

IM 153-2 High Feature Outdoor	
Bus connection	
<ul style="list-style-type: none"> Connection for PROFIBUS DP 	9-pin D-sub connector, contact assignment as described in IEC 61158/EN 50170, Vol. 2
Connectable lower-level components	
Number of couplers	
<ul style="list-style-type: none"> DP/PA coupler Y coupler 	Max. 5 1
Number of PA devices on PROFIBUS PA	Max. 64
Module-specific data	
Degree of protection	IP20
Transmission rate of the higher level DP master system	9.6; 19.2; 45.45; 93.75; 187.5; 500 Kbps 1.5; 3; 6; 12 Mbps
Communication protocol	PROFIBUS DP
Frame length	
<ul style="list-style-type: none"> I/O data Configuration frame Diagnostics frame Parameter assignment frame 	Max. 244 bytes Max. 244 bytes Max. 244 bytes Max. 244 bytes
Voltages, currents, potentials	
Supply voltage	24 V DC (20.4 ... 28.8 V)
Reverse polarity protection	Yes
Voltage failure bridging	20 ms
Galvanic isolation	
<ul style="list-style-type: none"> To the higher-level DP master system To the DP/PA coupler or Y coupler 	Yes No
Power consumption of modules (24 V DC)	
<ul style="list-style-type: none"> In the PA link In the Y link 	Max. 200 mA (at 20.4 V) Max. 400 mA (at 20.4 V)
Module power loss	
<ul style="list-style-type: none"> In the PA link In the Y link 	Max. 2.6 W (at 28.8 V) Max. 3.6 W (at 28.8 V)
Infeed, mechanical design	4-pin screw terminal, short-circuiting link between PE and M24; the short-circuiting link must be removed for floating operation (independent of this, the DP interface is always floating)
Status, interrupts, diagnostics	
Diagnostics displays	
<ul style="list-style-type: none"> Group error Bus error on higher level DP master system Bus error on underlying bus system Module is active in redundancy mode 24 V DC power supply monitoring 	Red LED "SF" Red LED "BF 1" Red LED "BF 2" Yellow "ACT" LED Green "ON" LED
Climatic conditions	
Permissible operating temperature	
<ul style="list-style-type: none"> Horizontal installation Vertical installation 	-25 to +60 °C -25 to +40 °C
Dimensions and weight	
Dimensions (W × H × D) in mm	40 × 125 × 130
Weight	Approx. 360 g

Overview



Active field distributor AFD4

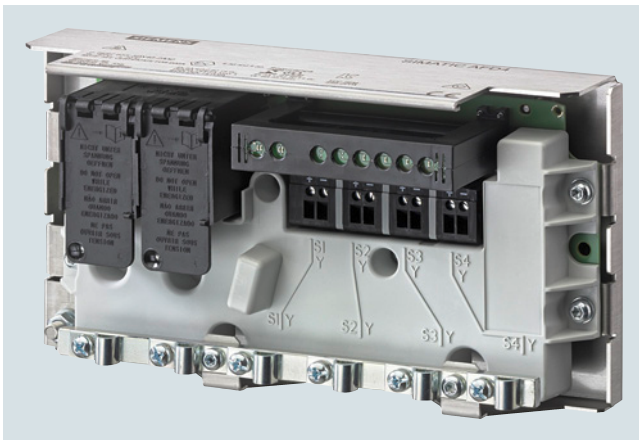

Active field distributor AFD4 RAILMOUNT



Active field distributor AFD8

Active field distributor AFD

Active field distributors (AFD) can be operated in environments in accordance with Division 2, Zone 2 or Zone 22. The following versions are available:

- AFD4, AFD4 RAILMOUNT and AFD4 FM, with 4 spur line connections for 1 field device each
- AFD8 with 8 spur line connections for 1 field device each

An AFD4, AFD4 RAILMOUNT and AFD4 FM can therefore connect up to 4 field devices, and an AFD8 can connect up to 8 standard-compliant PROFIBUS PA field devices via short-circuit proof spur line connections to a PA fieldbus segment (line/ring) with automatic bus termination.

The PA fieldbus segment can be connected to a single or redundant PROFIBUS DP via a PA gateway and can thus be seamlessly integrated into the SIMATIC PCS 7 process control system.

Up to 8 AFD active field distributors with a total of up to 31 connected field devices can be operated for each fieldbus segment. The number of field devices is also limited by the current consumption of the field devices. A maximum of 60 mA per spur line and a maximum of 1 A per segment is available for the field devices.

An AFD in a ring segment can be replaced during operation without resulting in failure of the segment.

For compliance with IP66 degree of protection, it is necessary to protect unused spur line connections using blanking plugs.



Active field distributor AFD8, open

Based on the AFD4, two product variants were developed with the AFD4 RAILMOUNT and the AFD4 FM for different purposes:

Specific product features of the AFD4 RAILMOUNT

The AFD4 RAILMOUNT is supplied without die-cast aluminum housing. It is a product variant of the AFD4 active field distributor with flexible installation options. It can be installed on a top hat DIN rail into an enclosure of choice, for example, one made of stainless steel, die-cast aluminum or plastic.

Specific product features of the AFD4 FM

The AFD4 FM with cFMus approval is adapted to the special requirements for product variants of the AFD4 active field distributor in the USA and Canada. The AFD4 FM features threaded plugs ex factory, because the cable glands of the AFD4 do not conform to the requirements of cFMus.

The threaded plugs for connecting the main and spur lines must be replaced by the cable glands and cables listed by UL or CSA. They must conform to the US National Electrical Code (NEC) and Canadian Electrical Code (CEC). The user is responsible for selection and ordering.

Available suppliers for suitable cable glands:

- Cooper Capri SAS
- CMP products

Due to the larger bushing for the main line (M20 instead of M16), sheathed main line cables can also be used for AFD4 FM.

The relevant requirements of the US National Electrical Code (ANSI/NFPA-70 NEC) must be met for installation of the AFD4 FM.

SIMATIC PCS 7 system hardware

Industrial communication
PROFIBUS

PROFIBUS PA > Active field distributors for PA components

Overview (continued)

AFDiSD active field distributor



AFDiSD active field distributor

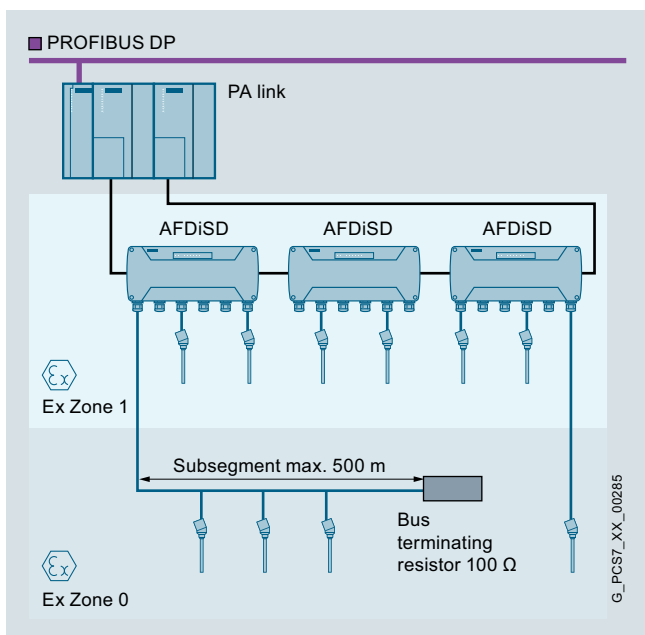

The AFDiSD (active field distributor intrinsically safe with optional extended PROFIBUS PA diagnostics) PROFIBUS PA field distributor can be operated in environments in accordance with Ex zone 1/21 and 2/22. It is a compatible replacement for AFDiS.

AFDiSDs can integrate up to 6 intrinsically safe PA field devices in a PA fieldbus segment (line/ring) via their intrinsically safe, short-circuit proof spur line connections. Instead of the spur line, it is also possible to use a subsegment for 3 to 4 devices with a max. length of 500 m at connection S1. The spur lines with Ex [ia] type of protection, as well as the subsegment, can be routed into Zone 0/20.

Up to 5 AFDiSD active field distributors with a total of up to 31 field devices can be operated in a fieldbus segment. A limit of 5 active field distributors is also mandatory for mixed operation of AFD and AFDiSD (extended PA fieldbus diagnostics in mixed operation).

The number of field devices per segment additionally depends on the current consumption of the devices and the cable lengths used. A current of 1 A is available for all field devices and the active field distributors of the segment.

With its integrated repeater function, AFDiSDs have the following advantages compared to the AFD:

- Spur line lengths are independent of the total number of spur lines in the bus segment
- Spur line lengths need not be taken into account when determining the total length of the bus segment

In environments in accordance with Ex Zone 2/22 or in non-hazardous areas, an AFDiSD in a ring segment can be replaced during operation without failure of the segment.

For compliance with IP66 degree of protection, it is necessary to protect unused spur line connections using blanking plugs.

Enhanced fieldbus diagnostics with AFDiSD in PROFIBUS PA

AFDiSD diagnostics are limited to short-circuits, loss of redundancy, detection of chatter, and failure of field devices. In addition, the extended fieldbus diagnostics, which can be activated per mode selector, enables comprehensive diagnostics of the entire PROFIBUS PA segment.

This includes, among others, the detection, recording and monitoring of:

- Topology (DP/PA coupler, AFDiSD)
- Voltage and current on the main and spur lines
- Signal and noise levels
- Capacitive unbalance to shield of main line

Configuration errors or defects can thus be rapidly detected and eliminated.

However, a prerequisite for application of the extended fieldbus diagnostics is that all active field distributors of the segment as well as the components of the PA link support this functionality. The following components satisfy this requirement:

- Active field distributor AFDiSD, Article No. 6ES7655-5DX60-1BB0
- IM 153-2 High Feature Outdoor interface module, Article No. 6ES7153-2BA70-0XB0
- DP/PA coupler FDC 157, Article No. 6ES7157-0AC85-0XA0

The interface module creates a topology model of the connected bus segment, and maps its status information. The DP/PA coupler and the locally installed active field distributor AFDiSD provide the interface module with the physical data of the bus segment for this purpose, as well as information on the status of the connected lines. The information provided by the interface module can be displayed on the PCS 7 Maintenance Station and evaluated by SIMATIC PDM.

When delivered from the factory, the enhanced fieldbus diagnostics is not activated in the AFDiSD. In this state, the functionality of the AFDiSD is equivalent to that of the AFDiS predecessor type.

Ordering data	Article No.	Accessories	Article No.
<p>Active field distributor (AFD) For integration of standard-compliant PA or FF field devices</p> <p><u>4 short-circuit-proof spur line connections for 1 field device each</u></p> <ul style="list-style-type: none"> • AFD4 with cable glands • AFD4 RAILMOUNT (without enclosure) For mounting on a DIN mounting rail in a suitable enclosure • AFD4 FM with threaded plugs cFmus approvals for USA and Canada <u>Note: Cable glands must be ordered separately.</u> <p><u>8 short-circuit-proof spur line connections for 1 field device each</u></p> <ul style="list-style-type: none"> • AFD8 with cable glands 	<p>6ES7157-0AG81-0XA0 6ES7655-5DX40-2AA0</p> <p>6ES7655-5DX40-1AA1</p> <p>6ES7157-0AG82-0XA0</p>	<p>Blanking plugs For unused connections on the AFD and AFDiSD, 10 units</p> <p><u>Additional components required for extended fieldbus diagnostics with AFDiSD</u></p> <p>IM 153-2 High Feature Outdoor Interface module for PROFIBUS DP for ET 200M, PA link and Y link; redundancy capable; conformal coating, IP20 degree of protection; permissible operating temperature -25 to +60 °C</p> <p>DP/PA coupler FDC 157</p>	<p>6ES7157-0AG80-1XA1</p> <p>6ES7153-2BA70-0XB0</p> <p>6ES7157-0AC85-0XA0</p>
<p>AFDiSD (active field distributor intrinsically safe with optional extended PROFIBUS PA diagnostics) With 6 short-circuit proof spur line connections for the integration of standard-compliant intrinsically-safe PA or FF field devices</p>	<p>6ES7655-5DX60-1BB0</p>		

SIMATIC PCS 7 system hardware

Industrial communication

PROFIBUS

PROFIBUS PA > Active field distributors for PA components**Technical specifications**

Article number	6ES7157-0AG81-0XA0 ACTIVE FIELD DISTRIBUTOR AFD4	6ES7655-5DX40-2AA0 ACTIVE FIELD DISTRIBUTOR AFD4 RAILMOUNT	6ES7655-5DX40-1AA1 ACTIVE FIELD DISTRIBUTOR AFD4 FM	6ES7157-0AG82-0XA0 ACTIVE FIELD DISTRIBUTOR AFD8
General information				
Product function				
• Repeater function	No	No	No	No
Supply voltage				
Reverse polarity protection	Yes; only in conjunction with FDC 157			Yes; only in conjunction with FDC 157
Overtoltage protection	No			No
Input current				
Current consumption (in no-load operation), typ.	24 mA; 54 mA at the end of the cable	24 mA; 54 mA at the end of the cable	24 mA; 54 mA at the end of the cable	34 mA; 64 mA at the end of the cable
Current consumption, max.	264 mA			514 mA
Power loss				
Power loss, typ.	384 mW	384 mW	384 mW	544 mW
Power loss, max.	3.2 W	3.2 W	3.2 W	4.1 W
Interfaces				
PROFIBUS PA				
• Transmission rate, max.	31.25 kbit/s	31.25 kbit/s	31.25 kbit/s	31.25 kbit/s
• Number of connectable PA field devices	4	4	4	8
• Current output to PA field devices, max.	240 mA	240 mA	240 mA	480 mA
• permissible current per spur line	60 mA	60 mA	60 mA	60 mA
Protocols				
PROFIBUS DP	No		No	No
PROFIBUS PA	Yes	Yes	Yes	Yes
AS-Interface	No		No	No
FOUNDATION Fieldbus H1	Yes	Yes	Yes	Yes
Interrupts/diagnostics/status information				
Status indicator	Yes	Yes	Yes	Yes
Alarms	No	No	No	No
Diagnostics function	Yes	Yes	Yes	Yes
Diagnostics indication LED				
• Main line status	Yes	Yes	Yes	Yes
• Main line failure	Yes			Yes
• Spur line status/fault	Yes	Yes	Yes	Yes
• automatic bus termination	Yes	Yes	Yes	Yes
Potential separation				
between main line and spur lines	No	No	No	No
Degree and class of protection				
IP degree of protection	IP66	IP20	IP66	IP66
Standards, approvals, certificates				
Use in hazardous areas				
• ATEX Zone 1	No	No	No	No
• ATEX Zone 21	No	No	No	No
• ATEX Zone 2	Yes	Yes	Yes	Yes
• ATEX Zone 22	Yes	Yes	Yes	Yes
• FM Class I Zone 1	No	No	No	No
• FM Class I Zone 2, Division 2	Yes	Yes	Yes	Yes

Technical specifications (continued)

Article number	6ES7157-0AG81-0XA0 ACTIVE FIELD DISTRIBUTOR AFD4	6ES7655-5DX40-2AA0 ACTIVE FIELD DISTRIBUTOR AFD4 RAILMOUNT	6ES7655-5DX40-1AA1 ACTIVE FIELD DISTRIBUTOR AFD4 FM	6ES7157-0AG82-0XA0 ACTIVE FIELD DISTRIBUTOR AFD8
Ambient conditions				
Ambient temperature during operation				
• min.	-40 °C	-40 °C	-40 °C	-40 °C
• max.	70 °C	70 °C	70 °C	70 °C
Ambient temperature during storage/transportation				
• min.	-40 °C	-40 °C	-40 °C	-40 °C
• max.	85 °C	70 °C	85 °C	85 °C
Relative humidity				
• Operation, max.	95 %			95 %
Connection method				
Main line				
• Number of main lines	2	2	2	2
• Design of terminals	Screw terminal block	Screw terminal block	Screw terminal block	Screw terminal block
• Type of connection (enclosure cable gland)	M16		M20	M16
• Type of cable	Type A	Type A	Type A	Type A
• Cable diameter, min.	4 mm		6 mm	4 mm
• Cable diameter, max.	9 mm		13 mm	9 mm
• Conductor cross-section, min.	0.2 mm ²	0.2 mm ²	0.2 mm ²	0.2 mm ²
• Conductor cross-section, max.	2.5 mm ²	2.5 mm ²	2.5 mm ²	2.5 mm ²
• automatic bus termination	Yes	Yes	Yes	Yes
• permissible main line current	1 A	1 A	1 A	1 A
Spur line				
• Number of spur lines	4	4	4	8
• Design of terminals	Screw terminal block		Screw terminal block	Screw terminal block
• Type of connection (enclosure cable gland)	M16		M16	M16
• Type of cable	Type A	Type A	Type A	Type A
• Cable diameter, min.	4 mm		4 mm	4 mm
• Cable diameter, max.	9 mm		9 mm	9 mm
• Conductor cross-section, min.	0.2 mm ²	0.2 mm ²	0.2 mm ²	0.2 mm ²
• Conductor cross-section, max.	2.5 mm ²	2.5 mm ²	2.5 mm ²	2.5 mm ²
• total current output to field devices, max.	240 mA	240 mA	240 mA	480 mA
• Number of connectable field devices	4	4	4	8
• Current limitation per field device, max.	60 mA	60 mA	60 mA	60 mA
• No-load voltage, max.	30 V		30 V	
• Short-circuit current (test current); max.	6 mA	6 mA	6 mA	6 mA
• intrinsically safe according to FISCO model	No	No	No	No
• Debounce logic	Yes	Yes	Yes	Yes
Dimensions				
Width	220 mm	220 mm	220 mm	360 mm
Height	120 mm; without screw glands	120 mm	120 mm	120 mm; without screw glands
Depth	83 mm	83 mm	83 mm	83 mm
Weights				
Weight, approx.	2 000 g	1 000 g	2 000 g	3 000 g

SIMATIC PCS 7 system hardware

Industrial communication

PROFIBUS

PROFIBUS PA > Active field distributors for PA components

Technical specifications (continued)

Article number	6ES7655-5DX60-1BB0
	ACTIVE FIELD DISTRIBUTOR AFDISD
General information	
Product function	
• Repeater function	Yes
Supply voltage	
Design of the power supply	via fieldbus
Reverse polarity protection	Yes; only in conjunction with FDC 157
Overvoltage protection	Yes; only in conjunction with FDC 157
Input current	
Current consumption, max.	400 mA; at 20 V input voltage
Current consumption in the case of short-circuit at all spur lines	100 mA; at 24 V input voltage
Power loss	
Power loss, typ.	1.4 W; minimum - typ. specification not possible because load-dependent
Power loss, max.	5.9 W
Interfaces	
PROFIBUS PA	
• Transmission rate, max.	31.25 kbit/s
• Number of connectable PA field devices	6
• Current output to PA field devices, max.	260 mA; max. 180 mA total current of all field devices for operation in the permissible operating voltage range from 16 V to 32 V
• permissible current per spur line	40 mA; first spur line 60 mA
Protocols	
PROFIBUS DP	No
PROFIBUS PA	Yes
AS-Interface	No
FOUNDATION Fieldbus H1	Yes
Interrupts/diagnostics/status information	
Status indicator	Yes
Alarms	No
Diagnostics function	Yes
Diagnostics indication LED	
• Main line status	Yes
• Main line failure	Yes
• Spur line status/fault	Yes
• automatic bus termination	Yes
Potential separation	
between main line and spur lines	Yes
Degree and class of protection	
IP degree of protection	IP66
Standards, approvals, certificates	
Use in hazardous areas	
• ATEX Zone 1	Yes
• ATEX Zone 21	Yes
• ATEX Zone 2	Yes
• ATEX Zone 22	Yes
• FM Class I Zone 1	No
• FM Class I Zone 2, Division 2	No
• Type of protection acc. to KEMA	14 ATEX 0044
• Test number KEMA	14 ATEX 0044

Article number	6ES7655-5DX60-1BB0
	ACTIVE FIELD DISTRIBUTOR AFDISD
Ambient conditions	
Ambient temperature during operation	
• min.	-40 °C
• max.	70 °C
Ambient temperature during storage/transportation	
• min.	-40 °C
• max.	70 °C
Relative humidity	
• Operation, max.	95 %
Connection method	
Main line	
• Number of main lines	2
• Design of terminals	Screw terminal block
• Type of connection (enclosure cable gland)	M20
• Type of cable	Type A
• Cable diameter, min.	6 mm
• Cable diameter, max.	13 mm
• Conductor cross-section, min.	0.2 mm ²
• Conductor cross-section, max.	2.5 mm ²
• automatic bus termination	Yes
• permissible main line current	1 A
Spur line	
• Number of spur lines	6
• Design of terminals	Screw terminal block
• Type of connection (enclosure cable gland)	M16
• Type of cable	Type A
• Cable diameter, min.	4 mm
• Cable diameter, max.	9 mm
• Conductor cross-section, min.	0.2 mm ²
• Conductor cross-section, max.	2.5 mm ²
• total current output to field devices, max.	260 mA; max. 180 mA total current of all field devices for operation in the permissible operating voltage range from 16 V to 32 V
• Number of connectable field devices	6
• Current limitation per field device, max.	40 mA; 60 mA on S1
• No-load voltage, max.	15.3 V
• short-circuit proof	Yes
• Short-circuit current (test current); max.	6 mA
• intrinsically safe according to FISCO model	Yes
• Debounce logic	Yes
Dimensions	
Width	380 mm
Height	85 mm
Depth	170 mm
Weights	
Weight, approx.	4 500 g

Overview

The following cables in different colors are offered for setting up PROFIBUS PA networks in accordance with IEC 61158-2 (for detailed information, refer to the IK PI Catalog, Industry Mall, or CA 01 Offline Mall under Network components for PROFIBUS, Electrical networks (PROFIBUS PA)):

- PROFIBUS FC Process Cable, 2-wire, shielded, black sheath
For applications in non-intrinsically safe areas



- PROFIBUS FC Process Cable, 2-wire, shielded, blue sheath
For applications in intrinsically safe areas

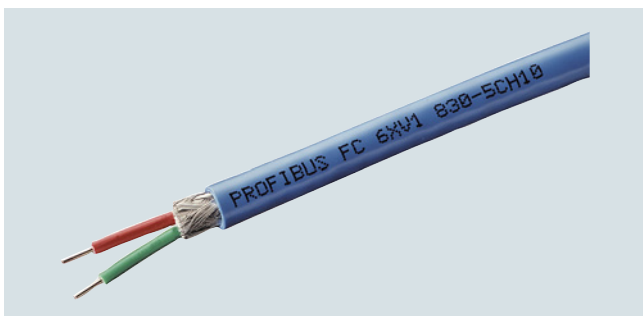

The FastConnect stripping tool can be used to strip the outer sheath and shield of the PROFIBUS FC Process Cables to the required lengths for PROFIBUS PA.

Design

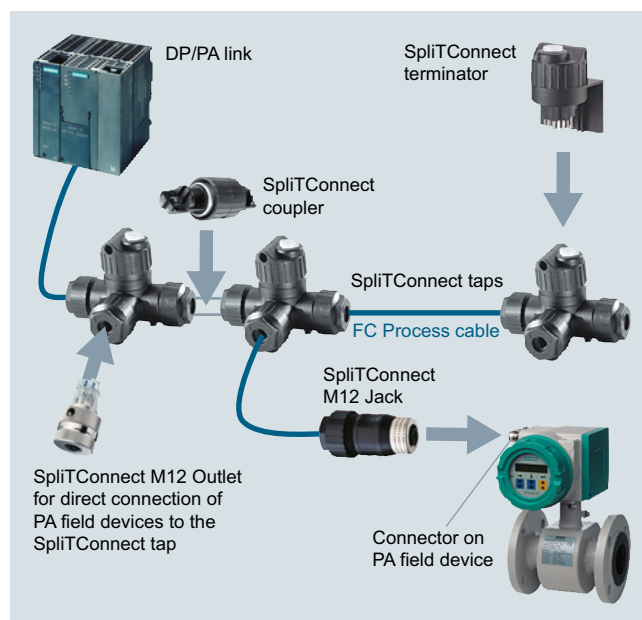

SplitConnect

The SplitConnect tap enables the design of fieldbus segments according to IEC 61158-2 with field device terminal points.

The SplitConnect coupler can be used to construct a PROFIBUS PA hub by connecting SplitConnect taps in series.

By replacing the contacting screw with the SplitConnect terminator, the SplitConnect tap can be used as a bus terminating element.

Terminal equipment can be connected directly through the FC process cable. Using the SplitConnect M12 outlet, PA field devices can also be connected to the SplitConnect tap by means of an M12 connection. The SplitConnect M12 jack is a connecting element between an FC process cable and an M12 connector on the PROFIBUS PA field device. For details on SplitConnect network components, see Catalog IK PI.

Ordering data

PROFIBUS FC Process Cable

2-wire, shielded

- Sheath color: blue; for intrinsically safe applications
- Sheath color: black; for non-intrinsically safe applications

Sold by the meter: Max. delivery unit 1 000 m, minimum order quantity 20 m

PROFIBUS FastConnect Stripping Tool

Tool for fast stripping of the PROFIBUS FastConnect bus cable

PROFIBUS FastConnect Blade Cassettes

Spare blade cassettes for PROFIBUS FastConnect stripping tool, 5 units

SplitConnect Tap

For implementing PROFIBUS PA segments and connecting PA field devices, insulation displacement system, IP67, 10 units

Article No.

6XV1830-5EH10

6XV1830-5FH10

6GK1905-6AA00

6GK1905-6AB00

6GK1905-0AA00

Article No.

SplitConnect M12 Outlet

Element for direct attachment of PA field devices to the SplitConnect Tap, 5 units

6GK1905-0AB10

SplitConnect Coupler

Connection element for cascading SplitConnect Taps to create neutral points, 10 units

6GK1905-0AC00

SplitConnect Terminator

For connecting PROFIBUS PA segments, 5 units

- Terminator (Ex); can be used in hazardous areas
- Terminator (non-Ex); cannot be used in hazardous areas

6GK1905-0AD00

6GK1905-0AE00

SplitConnect M12 jack

Connection element between an FC process cable and M12 connector on the PROFIBUS PA field device, 5 units

6GK1905-0AF00

SIMATIC PCS 7 system hardware

Industrial communication

FOUNDATION Fieldbus H1

Overview



Compact FF Link, redundant

Depending on operator preference, FOUNDATION Fieldbus (FF) H1 can be used in addition to PROFIBUS PA as the fieldbus for the direct connection of transmitters and actuators to the SIMATIC PCS 7 process control system.

Design

Examples of FOUNDATION Fieldbus H1 architectures

When FOUNDATION Fieldbus H1 is integrated in the SIMATIC PCS 7 process control system, PROFIBUS DP acts as a link. The following graphical representations show possible FOUNDATION Fieldbus H1 architectures with:

- PROFIBUS DP master in non-redundant design (AS Single Station)
- PROFIBUS DP master in redundant design (AS Redundancy Station)

Depending on the configured PROFIBUS DP master, the gateway between PROFIBUS DP and FOUNDATION Fieldbus H1 is formed by a single Compact FF Link (AS Single Station) or a redundant Compact FF Link pair (AS Redundancy Station) (for details, see graphics). One FF fieldbus segment can be operated on each gateway.

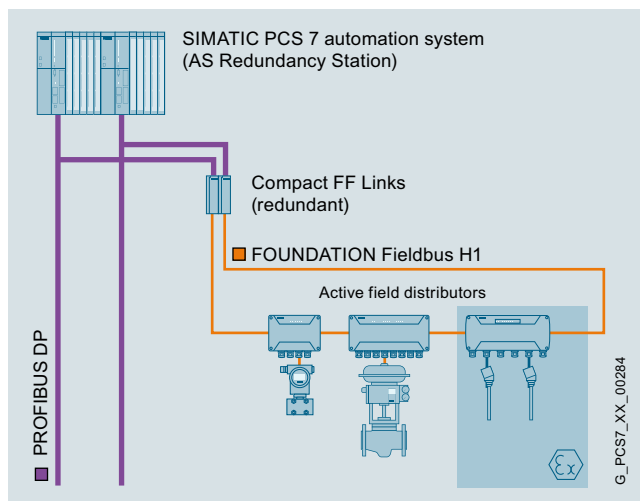

FOUNDATION Fieldbus H1 on an AS Redundancy Station as PROFIBUS DP master

Line architecture with single Compact FF Link

A line segment can be connected to an individual PROFIBUS DP line via a Compact FF Link. The FF-field devices can be integrated into the line segment via AFD active field distributors, e.g. AFD4, AFD4 RAILMOUNT, AFD4 FM and AFD8 (approval for Ex Zone 2/22) and AFDiSD (approval for Ex Zone 1/21). The FF-field devices are connected to these field distributors using short-circuit-proof spur lines.

Alternatively, it is possible to operate up to 8 AFD field distributors, up to 5 AFDiSD field distributors or any combination of up to 5 AFDiSD and AFD field distributors in a line segment. The last field distributor at the end of the line farthest away from the Compact FF Link automatically activates its bus terminating resistor.

Ring architecture with redundant Compact FF Links

The highest availability can be achieved with a FOUNDATION Fieldbus H1 ring segment, which can be connected to a redundant PROFIBUS DP via a redundant Compact FF Link pair.

The FF field devices are integrated into the ring segment using the short-circuit-proof spur lines of the AFD or AFDiS active field distributors. The number of field distributors is limited as with the line architectures (up to 8 AFD, up to 5 AFDiS or any combination of up to 5 AFDiS and AFD).

The bus is terminated automatically and is immediately adapted in the event of changes or faults on the bus. An extension on the fieldbus or replacement of a Compact FF Link during operation is possible.

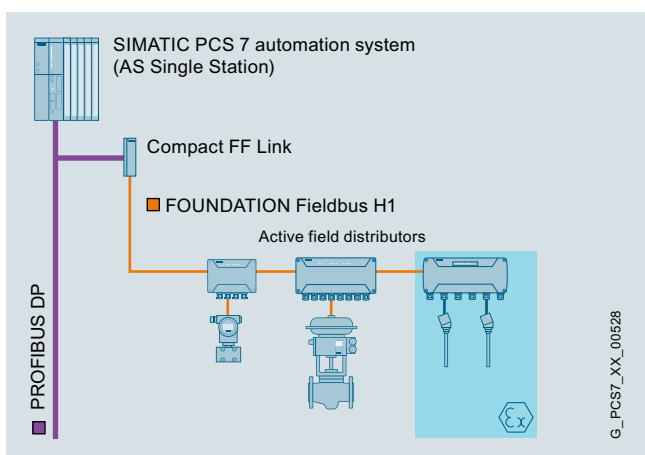

FOUNDATION Fieldbus H1 on an AS Single Station as PROFIBUS DP master

Function

Properties of FOUNDATION Fieldbus H1

Like PROFIBUS PA, the FOUNDATION Fieldbus H1 is based on IEC 61158-2. With MBP (Manchester coded Bus Powered) transmission system, digital data is transmitted and power is supplied to the bus nodes on a shielded two-wire cable. The constant transmission rate is 31.25 Kbps.

Up to 32 bus nodes (Compact FF Link + field devices) can be operated on one fieldbus segment (typically 8 to 12 devices). The field devices are integrated into the fieldbus segment via AFD (approval for Ex Zone 2/22) or AFDiS (approval for Ex Zone 1/21) active field distributors. Intrinsically-safe FF devices connected via AFDiS active field distributors can be installed in hazardous areas in accordance with Ex Zone 1/21 or 0/20.

The total length of the fieldbus segment is restricted to 1 900 m. If AFDs (active field distributors) are used, both the length of the spur lines for connecting devices and the quality of the cable used must also be considered when calculating the total length of the bus segment. Spur lines on the AFDiSD are not relevant to the total length of the bus segment.

The spur lines can have the following maximum lengths:

- Up to 120 m in accordance with IEC 61158-2
- Up to 120 m in accordance with IEC 60079-27 (FISCO)

With AFD active field distributors, the maximum values are reduced if necessary, depending on the number of spur lines of the bus segment (for details, see the "Technical specifications" section). With AFDiSD active field distributors, this reduction is canceled by the integrated repeater function.

The **SIMATIC Fieldbus Calculator** provides help in calculating and designing fieldbus segments:
<https://support.industry.siemens.com/cs/ww/en/view/53842953>

The FOUNDATION Fieldbus H1 combines cyclic and acyclic communication. Time-critical tasks such as the transfer of process data are executed cyclically according to an exact processing schedule. On the other hand, non-time-critical information such as maintenance/diagnostics data or configuration data is transferred acyclically.

Device management with EDD

The field device data for the following block types are distributed according to the block model:

- Device block (device-specific information)
- Function block (implemented functions)
- Transmission block (function for controlling input/output variables of a function block)

Fieldbus Foundation provides pre-defined device descriptions (standard DD) for the basic functions of specific field device types. The basic functions of the devices (e.g. analog input, digital output, etc.) are implemented by means of various standard function and transmission blocks.

The device descriptions are interpreted with SIMATIC PDM.

Control in the field

Function and transmission blocks can also be interconnected to form control loops. Together with suitable field devices, such a control application operates independent of the controller (automation system) of the control system.

Characteristic features at a glance

- Bus power supply to the field devices
- Topology: Line, tree, ring
- Integration of intrinsically safe field devices in hazardous areas with barriers
- Deterministic time response
- Interoperability due to standardized bus interface and device integration with standardized device descriptions
- Support of "Control in the field"

Integration

Integration in SIMATIC PCS 7

The FOUNDATION Fieldbus H1 can be integrated seamlessly in the SIMATIC PCS 7 process control system using PROFIBUS DP as link. The gateway between PROFIBUS DP and FOUNDATION Fieldbus H1 is realized with Compact FF Links. Either a single Compact FF Link or a redundant pair is used based on the selected bus architecture (see "Design" section).

Engineering of the FOUNDATION Fieldbus H1 segments is implemented as for PROFIBUS PA. Diagnostic information and configured maintenance information for Compact FF Links and FF devices are available via the SIMATIC PCS 7 Maintenance Station. SIMATIC PCS 7 generates the diagnostics screens automatically.

System requirements

- System software SIMATIC PCS 7 V8.1+ SP1 or higher
- SIMATIC PDM V8.2+SP1 or higher with SIMATIC PDM Communication FOUNDATION Fieldbus

Technical specifications

FOUNDATION Fieldbus H1	
Data transmission	MBP
Transmission rate	31.25 Kbps
Cable	2-wire shielded
Topology	Line, tree, ring
FF devices per segment/FF Link	31
Active field distributors per segment/FF Link	
• AFD	8
• AFDiSD or combinations of AFDiSD and AFD	5
Max. total current consumption of all FF field devices	0.5 A
Cable length per segment	1 900 m
Bus segments with AFD	
<u>Max. spur line length in relation to the total number of spur lines</u>	
Number of spur lines (1 device per spur line)	
• 1 to 12 spur lines	120 m
• 13 to 14 spur lines	90 m
• 15 to 18 spur lines	60 m
• 19 to 24 spur lines	30 m
• 25 to 31 spur lines	1 m
Bus segments with AFDiSD	
<u>Max. spur line length independent of total number of spur lines</u>	
Number of spur lines (1 device per spur line)	
• 1 to 31 spur lines	
- Not intrinsically-safe	120 m
- Intrinsically-safe acc. to FISCO	120 m

SIMATIC PCS 7 system hardware

Industrial communication

FOUNDATION Fieldbus H1

FF network transitions

Overview

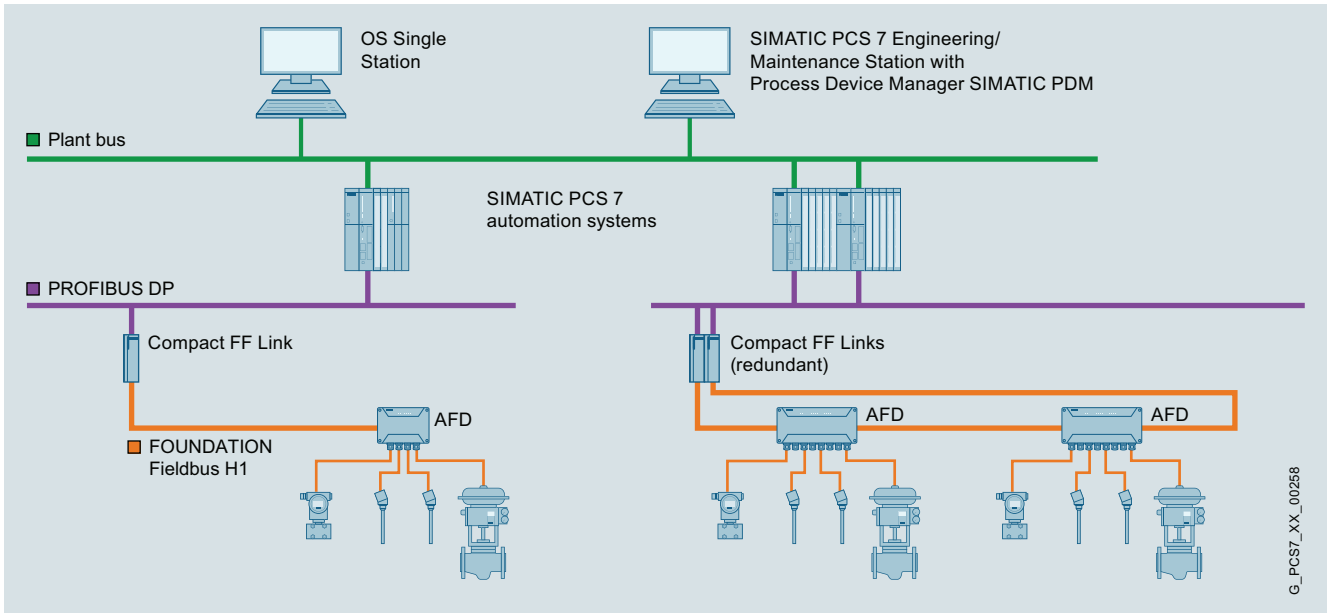

Examples of DP/FF gateways with Compact FF Link

A gateway based on the Compact FF Link between PROFIBUS DP and FOUNDATION Fieldbus H1 (FF) enables integration of a fieldbus segment with up to 31 standard-compliant FF-H1 field devices in the SIMATIC PCS 7 process control system. If the PROFIBUS DP master and PROFIBUS DP are implemented without redundancy, the gateway can be realized with a single Compact FF Link. With redundant implementation of the PROFIBUS DP master and PROFIBUS DP, a redundant Compact FF Link pair is required for the gateway.

The Compact FF Link is simultaneously a slave on PROFIBUS DP and the master on FOUNDATION Fieldbus H1. It decouples the hardware, communication protocols, and time response of the two bus systems.

A PROFIBUS address from 1 to 125 must be assigned for the Compact FF Link. In the case of redundant architecture, identical PROFIBUS addresses must be set for both Compact FF Links.

As the FF link master, the compact FF link controls the distributed communication of the FOUNDATION Fieldbus H1 segment deterministically using LAS (link active scheduler). If the Compact FF Link fails, a redundant partner module or a field device with the "Backup Link Master" property takes over the communication control. FF field devices in an FF segment are thus able to execute closed-loop control functions (Control in the Field) even independent of the higher-level controller.

G_PCS7_XX_00258

Design



Compact FF Link

The Compact FF Link is a S7-300 format device, consisting of a PROFIBUS DP interface (DPV1 slave) and a field device coupler for a subordinate FF bus segment. It can be operated individually or redundantly in a pair.

The following architectures are thus possible (also refer to "FOUNDATION Fieldbus H1" section under "Design"):

- Single PROFIBUS DP interface (1 × Compact FF Link)
 - Line architecture with single Compact FF Link
- Redundant PROFIBUS DP interface (2 × Compact FF Link)
 - Ring architecture with redundant Compact FF Link pair (link and media redundancy)

Compact FF Link in non-redundant mode

If the FF segment is connected to PROFIBUS DP via a single compact FF link, the link can be mounted directly on a standard mounting rail.

If the 24 V DC incoming supply is not from a central power supply of the plant, a PS 307 or PS 305 load power supply can be used.

Compact FF Links in redundant mode

In a redundant configuration, the BM Compact FF Link bus module is first mounted on a mounting rail for "hot swapping". The two redundant Compact FF Links are then inserted. This enables a Compact FF Link to be replaced during operation.

In the case of a redundant Compact FF Link pair, a redundant 24 V DC supply is also recommended, e.g. with two PS 307/PS 305 load power supplies.

Ordering data

Article No.

Compact FF Link

DP/FF gateway, 40 mm wide, FOUNDATION Fieldbus link master, with redundancy capability; physical interface to the FOUNDATION Fieldbus H1 with integrated bus power supply up to 0.5 A and integrated diagnostics; degree of protection IP20; for extended temperature range, permissible operating temperature -40 to +70 °C

6ES7655-5BA00-0AB0

Accessories

PS 307 load power supply
Including connecting comb; 120/230 V AC; 24 V DC

- 2 A; 40 mm wide
- 5 A; 60 mm wide
- 5 A, extended temperature range; 80 mm wide
- 10 A, 80 mm wide

6ES7307-1BA01-0AA0

6ES7307-1EA01-0AA0

6ES7307-1EA80-0AA0

6ES7307-1KA02-0AA0

PS 305 load power supply
24/48/60/110 V DC; 24 V DC

- 2 A, extended temperature range; 80 mm wide

6ES7305-1BA80-0AA0

Components for stand-alone operation

Standard mounting rails
(without hot swapping function)

- Width 482 mm (19")
- Width 530 mm

6ES7390-1AE80-0AA0

6ES7390-1AF30-0AA0

Components for redundant operation

BM Compact FF Link

Bus module for 2 Compact FF Links; for redundant operation

6ES7655-5EF00-0AA0

Mounting rail for hot swapping

- Width 482 mm (19")
- Width 530 mm
- Width 620 mm
- 2 000 mm wide

6ES7195-1GA00-0XA0

6ES7195-1GF30-0XA0

6ES7195-1GG30-0XA0

6ES7195-1GC00-0XA0

Covers

4 backplane bus covers and 1 cover for active bus module

6ES7195-1JA00-0XA0

SIMATIC PCS 7 system hardware

Industrial communication

FOUNDATION Fieldbus H1

FF network transitions

Technical specifications

Compact FF Link	
Design and equipment features	
Function	Bus link of PROFIBUS DP (slave functionality) and FOUNDATION Fieldbus H1 (link master functionality) with support of the "Configuration in Run" functionality
Installation type/mounting	Front mounting, preferably on mounting rail
Degree of protection according to EN 60529	IP20
Voltages, currents, potentials	
Rated supply voltage	24 V DC (20.4 V ... 28.8 V)
Input current, max. current consumption	1.3 A
External fusing of power supply lines (recommended)	Min. 4 A
Rated output voltage for FF H1	31 V DC \pm 1 V
• Overvoltage monitoring	U > 35 V; latching shutdown
• Voltage failure bridging	5 ms
Output current for FF H1 (for supply of all FF field devices)	0.5 A
Power loss	8 W
Galvanic isolation	
• FF H1 to PROFIBUS DP	Yes
• DP master system to FF H1	Yes
• FF H1/24 V DC supply / PROFIBUS DP	Yes
• All electric circuits/functional grounding	Yes
Frame length	
• Input/output data	244 bytes/244 bytes
• Configuration frame	Max. 244 bytes
• Diagnostics frame	Max. 244 bytes
• Parameter assignment frame	Max. 244 bytes
Interfaces	
Interface hardware	RS 485 - yes; FOC - no
PROFIBUS DP	
• Permissible device addresses	1 to 125
• Transmission rate (automatic detection)	Max. 12 Mbps
• Bus protocol/transmission protocol	PROFIBUS DP
• Transmission mode	RS 485
• Connection	9-pin D-sub connector
FOUNDATION Fieldbus H1	
• Transmission rate	31.25 Kbps
• Bus protocol/transmission protocol	FOUNDATION Fieldbus H1
• Transmission mode	MBP
• Connection	2-pin screw terminal

Status, interrupts, diagnostics	
Status displays	
• Group error	Red LED "SF"
• Bus error on higher level DP master system	Red "BF DP" LED
• Bus error on subordinate FF H1	Red "BF FF" LED
• Active PROFIBUS DP channel	Yellow "ACT DP" LED
• Active FF H1 channel	Yellow "ACT FF" LED
• 24 V DC power supply monitoring	Green "ON" LED
Climatic conditions	
Ambient temperature in operation	
• Horizontal installation	-40 to +70 °C
• Vertical installation	-40 to +50 °C
Permissible storage/transport temperature	-40 to +85 °C
Relative humidity during operation	Max. 95%, without condensation
Approvals for potentially explosive atmospheres	
• Gas	ATEX II 3 G Ex nA II T4
• Dust	No
• Equipment Ex ia/Ex ib	No/No
Standards, specifications, approvals	
CE mark according to 2004/108/EC, 94/9/EC	Yes
UL approval	Yes
RCM (formerly C-Tick)	Yes
KC certification	Yes
EAC (formerly Gost-R)	Yes
PROFIBUS standard	IEC 61784-1 CP 3/1
FOUNDATION Fieldbus guideline	IEC 61158-2
Dimensions and weight	
Dimensions (W x H x D) in mm	40 x 125 x 130
Weight	Approx. 350 g

Overview



Active Field Distributor AFD4

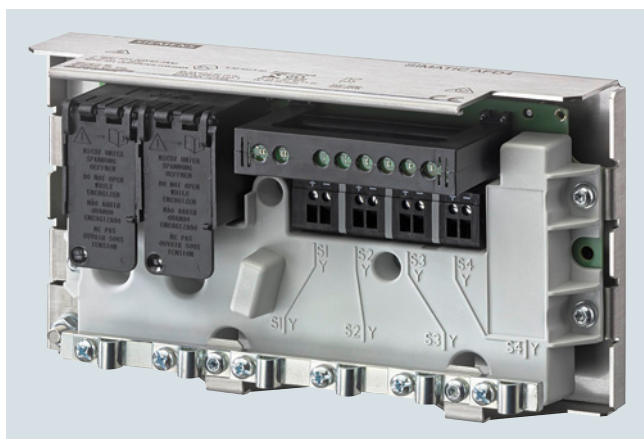

Active Field Distributor AFD4 RAILMOUNT



Active Field Distributor AFD8

Active Field Distributor AFD

Active field distributors (AFD) can be operated in environments in accordance with Division 2, Zone 2 or Zone 22. The following models are available:

- AFD4, AFD4 RAILMOUNT or AFD4 FM with 4 spur line connections for 1 field device each
- AFD8 with 8 spur line connections for 1 field device each

An AFD4/AFD4 RAILMOUNT/AFD4 FM can therefore integrate up to 4, and an AFD8 up to 8 standard-compliant FF (FOUNDATION Fieldbus H1) field devices via short-circuit proof spur line connections to a fieldbus segment (line/ring) with automatic bus termination.

The FF fieldbus segment can be connected to a single or redundant PROFIBUS DP via an FF gateway and can thus be seamlessly integrated into the SIMATIC PCS 7 process control system.

Up to 8 AFD active field distributors with a total of up to 31 connected field devices can be operated for each fieldbus segment. The number of field devices is also limited by the current consumption of the field devices. A maximum of 60 mA per spur line and a maximum of 0.5 A per segment is available for the field devices.

An AFD in a ring segment can be replaced during operation without resulting in failure of the segment.

For compliance with IP66 degree of protection, it is necessary to protect unused spur line connections using blanking plugs.

Based on the AFD4, two product versions with different intentions were developed with the AFD4 RAILMOUNT and the AFD4 FM:

Specific product features of the AFD4 RAILMOUNT

The AFD4 RAILMOUNT is supplied without die-cast aluminum enclosure; it is a product model of the AFD4 active field distributor with flexible installation options. It can be installed on a DIN mounting rail into an enclosure of choice, for example, one made of stainless steel, die-cast aluminum or plastic.

Specific product features of the AFD4 FM

The AFD4 FM with cFMus approval is adapted to the special requirements for product variants of the AFD4 active field distributor in the USA and Canada. The AFD4 FM features threaded plugs ex factory, because the cable glands of the AFD4 do not conform to the requirements of cFMus.

The threaded plugs for connecting the main and spur lines must be replaced by the cable glands and cables listed by UL or CSA. They must conform to the US National Electrical Code (NEC) and Canadian Electrical Code (CEC). The user is responsible for selection and ordering.

Available suppliers for suitable cable glands:

- Cooper Capri SAS
- CMP products

Due to the larger bushing for the main line (M20 instead of M16), sheathed main line cables can also be used for AFD4 FM.

The relevant requirements of the US National Electrical Code (ANSI/NFPA-70 NEC) must be met when installing the AFD4 FM.

SIMATIC PCS 7 system hardware

Industrial communication

FOUNDATION Fieldbus H1

Active field distributors for FF components

Overview (continued)

AFDiSD active field distributor



AFDiSD active field distributor

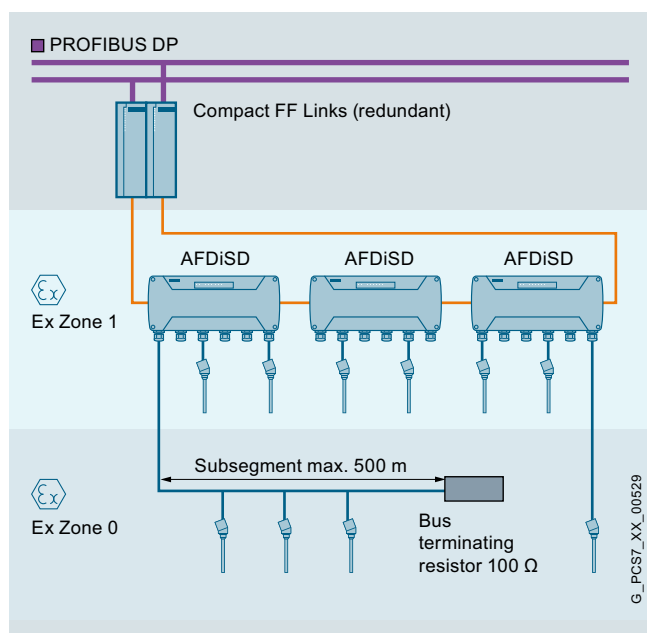

The AFDiS (Active Field Distributor intrinsically Safe) is an active field distributor for operating environments in accordance with Ex Zones 1/21 and 2/22. It can integrate up to 6 intrinsically-safe FF field devices into an FF fieldbus segment (line/ring) via its intrinsically-safe, short-circuit-proof spur line connections. Instead of the spur line, it is also possible to use a subsegment for 3 to 4 devices with a max. length of 500 m at connection S1 of the AFDiS. The spur lines with Ex [ia] type of protection as well as the subsegment can be routed into Zone 0/20.

Up to 5 AFDiS field distributors with a total of up to 31 field devices can be operated in a fieldbus segment. The limitation to 5 field distributors is also mandatory for mixed operation of AFD and AFDiS.

The number of field devices per segment additionally depends on the current consumption of the devices. A current of 0.5 A is available for all field devices of the segment.

With the integrated repeater function, the AFDiS has the following advantages compared to the AFD:

- Spur line lengths are independent of the total number of spur lines in the bus segment.
- Spur line lengths need not be taken into account when determining the total length of the bus segment.

In environments in accordance with Ex Zone 2/22 or in non-hazardous areas, an AFDiSD in a ring segment can be replaced during operation without failure of the segment.

For compliance with IP66 degree of protection, it is necessary to protect unused spur line connections using blanking plugs.

Ordering data

Article No.

Active field distributor (AFD)

For integration of standard-compliant PA or FF field devices

4 short-circuit-proof spur line connections for 1 field device each

- AFD4 with cable glands
- AFD4 RAILMOUNT (without enclosure)
For mounting on a DIN mounting rail in a suitable enclosure

6ES7157-0AG81-0XA0
6ES7655-5DX40-2AA0

8 short-circuit-proof spur line connections for 1 field device each

- AFD8 with cable glands

6ES7157-0AG82-0XA0

AFDiSD (active field distributor intrinsically safe with optional extended PROFIBUS PA diagnostics)

With 6 short-circuit proof spur line connections for the integration of standard-compliant intrinsically-safe PA or FF field devices

6ES7655-5DX60-1BB0

Accessories

Blanking plugs

For unused connections on the AFD and AFDiSD, 10 units

6ES7157-0AG80-1XA1

Technical specifications

Article number	6ES7157-0AG81-0XA0 ACTIVE FIELD DISTRIBUTOR AFD4	6ES7655-5DX40-2AA0 ACTIVE FIELD DISTRIBUTOR AFD4 RAILMOUNT	6ES7655-5DX40-1AA1 ACTIVE FIELD DISTRIBUTOR AFD4 FM	6ES7157-0AG82-0XA0 ACTIVE FIELD DISTRIBUTOR AFD8
General information				
Product type designation	Active Field Distributor AFD4	Active Field Distributor AFD4	Active Field Distributor AFD4 FM	Active Field Distributor AFD8
Product description			AFD4 FM	
Product function				
• Repeater function	No	No	No	No
Supply voltage				
permissible range, lower limit (DC)	16 V	16 V	16 V	16 V
permissible range, upper limit (DC)	32 V	32 V	32 V	32 V
Reverse polarity protection	Yes; only in conjunction with FDC 157			Yes; only in conjunction with FDC 157
Overvoltage protection	No			No
Input current				
Current consumption (in no-load operation), typ.	24 mA; 54 mA at the end of the cable	24 mA; 54 mA at the end of the cable	24 mA; 54 mA at the end of the cable	34 mA; 64 mA at the end of the cable
Current consumption, max.	264 mA			514 mA
Power loss				
Power loss, typ.	384 mW	384 mW	384 mW	544 mW
Power loss, max.	3.2 W	3.2 W	3.2 W	4.1 W
Interfaces				
PROFIBUS PA				
• Transmission rate, max.	31.25 kbit/s	31.25 kbit/s	31.25 kbit/s	31.25 kbit/s
• Number of connectable PA field devices	4	4	4	8
• Current output to PA field devices, max.	240 mA	240 mA	240 mA	480 mA
• permissible current per spur line	60 mA	60 mA	60 mA	60 mA
Protocols				
PROFIBUS DP	No		No	No
PROFIBUS PA	Yes	Yes	Yes	Yes
AS-Interface	No		No	No
FOUNDATION Fieldbus H1	Yes	Yes	Yes	Yes
Interrupts/diagnostics/status information				
Status indicator	Yes	Yes	Yes	Yes
Alarms	No	No	No	No
Diagnostics function	Yes	Yes	Yes	Yes
Diagnosics indication LED				
• Main line status	Yes	Yes	Yes	Yes
• Main line failure	Yes			Yes
• Spur line status/fault	Yes	Yes	Yes	Yes
• automatic bus termination	Yes	Yes	Yes	Yes
Potential separation				
between main line and spur lines	No	No	No	No
Degree and class of protection				
Degree of protection acc. to EN 60529				
• IP66	Yes	No	Yes	Yes
Standards, approvals, certificates				
Use in hazardous areas				
• ATEX Zone 1	No	No	No	No
• ATEX Zone 21	No	No	No	No
• ATEX Zone 2	Yes	Yes	Yes	Yes
• ATEX Zone 22	Yes	Yes	Yes	Yes
• FM Class I Zone 1	No	No	No	No
• FM Class I Zone 2, Division 2	Yes	Yes	Yes	Yes

SIMATIC PCS 7 system hardware

Industrial communication

FOUNDATION Fieldbus H1

Active field distributors for FF components

Technical specifications (continued)

Article number	6ES7157-0AG81-0XA0 ACTIVE FIELD DISTRIBUTOR AFD4	6ES7655-5DX40-2AA0 ACTIVE FIELD DISTRIBUTOR AFD4 RAILMOUNT	6ES7655-5DX40-1AA1 ACTIVE FIELD DISTRIBUTOR AFD4 FM	6ES7157-0AG82-0XA0 ACTIVE FIELD DISTRIBUTOR AFD8
Ambient conditions				
Ambient temperature during operation				
• min.	-40 °C	-40 °C	-40 °C	-40 °C
• max.	70 °C	70 °C	70 °C	70 °C
Ambient temperature during storage/transportation				
• min.	-40 °C	-40 °C	-40 °C	-40 °C
• max.	85 °C	70 °C	85 °C	85 °C
Relative humidity				
• Operation, max.	95 %			95 %
Connection method				
Main line				
• Number of main lines	2	2	2	2
• Design of terminals	Screw terminal block	Screw terminal block	Screw terminal block	Screw terminal block
• Type of connection (enclosure cable gland)	M16		M20	M16
• Type of cable	Type A	Type A	Type A	Type A
• Cable diameter, min.	4 mm		6 mm	4 mm
• Cable diameter, max.	9 mm		13 mm	9 mm
• Conductor cross-section, min.	0.2 mm ²	0.2 mm ²	0.2 mm ²	0.2 mm ²
• Conductor cross-section, max.	2.5 mm ²	2.5 mm ²	2.5 mm ²	2.5 mm ²
• automatic bus termination	Yes	Yes	Yes	Yes
• permissible main line current	1 A	1 A	1 A	1 A
Spur line				
• Number of spur lines	4	4	4	8
• Design of terminals	Screw terminal block		Screw terminal block	Screw terminal block
• Type of connection (enclosure cable gland)	M16		M16	M16
• Type of cable	Type A	Type A	Type A	Type A
• Cable diameter, min.	4 mm		4 mm	4 mm
• Cable diameter, max.	9 mm		9 mm	9 mm
• Conductor cross-section, min.	0.2 mm ²	0.2 mm ²	0.2 mm ²	0.2 mm ²
• Conductor cross-section, max.	2.5 mm ²	2.5 mm ²	2.5 mm ²	2.5 mm ²
• total current output to field devices, max.	240 mA	240 mA	240 mA	480 mA
• Number of connectable field devices	4	4	4	8
• Current limitation per field device, max.	60 mA	60 mA	60 mA	60 mA
• No-load voltage, max.	30 V		30 V	
• Short-circuit current (test current); max.	6 mA	6 mA	6 mA	6 mA
• intrinsically safe according to FISCO model	No	No	No	No
• Debounce logic	Yes	Yes	Yes	Yes
Dimensions				
Width	220 mm	220 mm	220 mm	360 mm
Height	120 mm; without screw glands	120 mm	120 mm	120 mm; without screw glands
Depth	83 mm	83 mm	83 mm	83 mm
Weights				
Weight, approx.	2 000 g	1 000 g	2 000 g	3 000 g

Technical specifications (continued)

Article number	6ES7655-5DX60-1BB0 ACTIVE FIELD DISTRIBUTOR AFDISD
General information	
Product function	
• Repeater function	Yes
Supply voltage	
Design of the power supply	via fieldbus
Reverse polarity protection	Yes; only in conjunction with FDC 157
Overvoltage protection	Yes; only in conjunction with FDC 157
Input current	
Current consumption, max.	400 mA; at 20 V input voltage
Current consumption in the case of short-circuit at all spur lines	100 mA; at 24 V input voltage
Power loss	
Power loss, typ.	1.4 W; minimum - typ. specification not possible because load-dependent
Power loss, max.	5.9 W
Interfaces	
PROFIBUS PA	
• Transmission rate, max.	31.25 kbit/s
• Number of connectable PA field devices	6
• Current output to PA field devices, max.	260 mA; max. 180 mA total current of all field devices for operation in the permissible operating voltage range from 16 V to 32 V
• permissible current per spur line	40 mA; first spur line 60 mA
Protocols	
PROFIBUS DP	No
PROFIBUS PA	Yes
AS-Interface	No
FOUNDATION Fieldbus H1	Yes
Interrupts/diagnostics/status information	
Status indicator	Yes
Alarms	No
Diagnostics function	Yes
Diagnostics indication LED	
• Main line status	Yes
• Main line failure	Yes
• Spur line status/fault	Yes
• automatic bus termination	Yes
Potential separation	
between main line and spur lines	Yes
Degree and class of protection	
IP degree of protection	IP66
Standards, approvals, certificates	
Use in hazardous areas	
• ATEX Zone 1	Yes
• ATEX Zone 21	Yes
• ATEX Zone 2	Yes
• ATEX Zone 22	Yes
• FM Class I Zone 1	No
• FM Class I Zone 2, Division 2	No
• Type of protection acc. to KEMA	14 ATEX 0044
• Test number KEMA	14 ATEX 0044

Article number	6ES7655-5DX60-1BB0 ACTIVE FIELD DISTRIBUTOR AFDISD
Ambient conditions	
Ambient temperature during operation	
• min.	-40 °C
• max.	70 °C
Ambient temperature during storage/transportation	
• min.	-40 °C
• max.	70 °C
Relative humidity	
• Operation, max.	95 %
Connection method	
Main line	
• Number of main lines	2
• Design of terminals	Screw terminal block
• Type of connection (enclosure cable gland)	M20
• Type of cable	Type A
• Cable diameter, min.	6 mm
• Cable diameter, max.	13 mm
• Conductor cross-section, min.	0.2 mm ²
• Conductor cross-section, max.	2.5 mm ²
• automatic bus termination	Yes
• permissible main line current	1 A
Spur line	
• Number of spur lines	6
• Design of terminals	Screw terminal block
• Type of connection (enclosure cable gland)	M16
• Type of cable	Type A
• Cable diameter, min.	4 mm
• Cable diameter, max.	9 mm
• Conductor cross-section, min.	0.2 mm ²
• Conductor cross-section, max.	2.5 mm ²
• total current output to field devices, max.	260 mA; max. 180 mA total current of all field devices for operation in the permissible operating voltage range from 16 V to 32 V
• Number of connectable field devices	6
• Current limitation per field device, max.	40 mA; 60 mA on S1
• No-load voltage, max.	15.3 V
• short-circuit proof	Yes
• Short-circuit current (test current); max.	6 mA
• intrinsically safe according to FISCO model	Yes
• Debounce logic	Yes
Dimensions	
Width	380 mm
Height	85 mm
Depth	170 mm
Weights	
Weight, approx.	4 500 g

SIMATIC PCS 7 system hardware

Industrial communication

FOUNDATION Fieldbus H1

Passive FF components**Overview**

Depending on the field of application, cables in different colors are offered for setting up FOUNDATION Fieldbus H1 networks in accordance with IEC 61158-2:

- FOUNDATION Fieldbus Cable, 2-wire, shielded, yellow sheath
For applications in non-intrinsically safe areas



- FOUNDATION Fieldbus Cable, 2-wire, shielded, blue sheath
For applications in intrinsically safe areas

**Ordering data****FOUNDATION Fieldbus Cable**

Bus cable according to IEC 61158-2, 2-wire, shielded; stranded filler wires

- Sheath color: yellow; for non-intrinsically safe applications
- Sheath color: blue; for intrinsically safe applications

Sold by the meter:
Max. delivery unit 1 000 m,
minimum order quantity 20 m

Article No.**6XV1830-5HH10****6XV1830-5GH10**

Overview

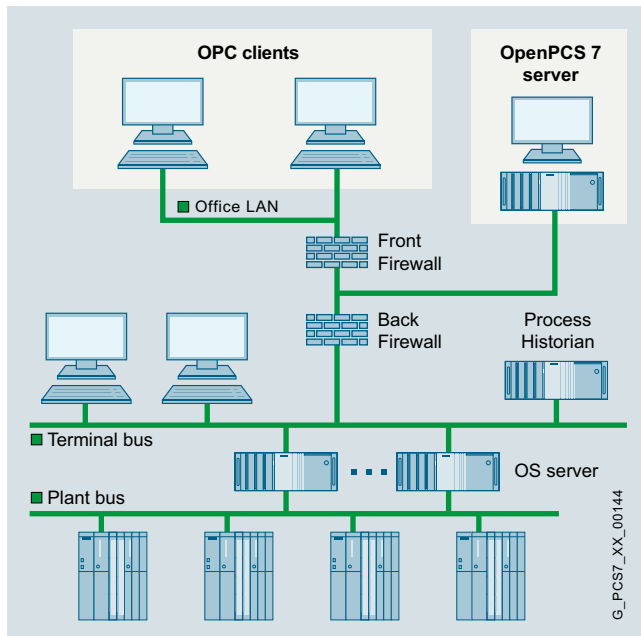

Use the OpenPCS 7 interface to directly integrate the SIMATIC PCS 7 process control system into host systems for production planning, process data evaluation and management. These higher-level systems (OPC clients) can access SIMATIC PCS 7 process data by means of the OpenPCS 7 server. However, access to SIMATIC BATCH data is not possible.

The OpenPCS 7 server collects data for the OPC clients. Depending on the system configuration, these data may be distributed across different SIMATIC PCS 7 stations (OS server, central archive server). It covers the distribution of data with respect to:

- Time period (OS1/OS2/...)
- Location (OS1/OS2/...)
- Redundancy (OS1 master/OS1 standby ...)

Design

The OpenPCS 7 server can be operated in two different configurations:

- Autonomous OpenPCS 7 server based on a SIMATIC PCS 7 Industrial Workstation in the client version (recommended preferred configuration)
- Multi-functional SIMATIC PCS 7 Industrial Workstation, client version, with OpenPCS 7 server and OS client functionalities (OpenPCS 7 server/OS client)

Function

The OpenPCS 7 interface is based on various OPC specifications (openness, productivity, collaboration). In addition to Microsoft's DCOM technology (Distributed Component Object Model), it also supports the more sophisticated OPC UA (Unified Architecture) protocol for communication between applications.

Special features of OPC UA:

- Data transfer combined with machine-readable semantic data description
- Platform independence
- Access via firewalls and over the Internet
- Communication reliability
- Security implementation

Access facilities of OPC clients

OPC DA (data access server) or
OPC UA DA (unified architecture data access)

For read and write access to process values

As an OPC DA or OPC UA DA server, the OpenPCS 7 server provides other applications with current data from the OS data management. The OPC client can log itself onto ongoing changes and also write values.

OPC HDA (historical data access server) or
OPC UA HA (unified architecture historical access)

For read access to archived process values

As an OPC HDA or OPC UA HA server, the OpenPCS 7 server provides other applications with historical data from the OS archive system. The OPC client, e.g. a reporting tool, can specifically request the required data by defining the start and end of a time interval. In addition, the OPC HDA server offers a wide range of aggregate functions, including variance, mean value and integral. This enables preprocessing by the HDA server, thus contributing to reducing the communication load.

OPC A&E (alarm & events server) or
OPC UA A&C (unified architecture alarms & conditions)

For read access to messages, alarms and events

As an OPC A&E or OPC UA A&C server, the OpenPCS 7 server passes on OS messages together with all accompanying process values to the subscribers at the production and corporate management levels. Some messages can be acknowledged there. Filter mechanisms and subscriptions ensure that only selected, modified data are transmitted.

OPC "H" A&E (historical alarm & events server)

For read access to archived alarms and messages

Thanks to a Siemens extension of the OPC A&E standard interface, the OpenPCS 7 server is able to transmit historic alarms and messages from the archive to subscribers at the production and corporate control levels. Archived messages cannot be read via OPC UA A&C.

OLE DB

Simple, standardized direct access to the archive data in the Microsoft SQL Server database of the operator system is possible with the OLE-DB. Through this, all OS archive data are accessible with the accompanying process values, message texts and user texts.

SIMATIC PCS 7 system hardware

Industrial communication

OpenPCS 7

Ordering data

Article No.

Multi-functional OpenPCS 7 Server/OS Client

SIMATIC PCS 7

OpenPCS 7/OS Client V9.1

OpenPCS 7 software for expansion of an existing OS Client with OpenPCS 7 Server functionality

6 languages (English, German, French, Italian, Spanish, Chinese), software class A, runs with Windows 10 Enterprise 2019 LTSC 64-bit, (see SIMATIC PCS 7 V9.1 Readme for the latest information), single license for 1 installation

Without SIMATIC PCS 7 Software Media Package

- Goods delivery
License key on USB flash drive, Certificate of License

6ES7658-0GX68-2YB0

- Online delivery
License key download, online Certificate of License

6ES7658-0GX68-2YH0

Note:
Email address required!

Autonomous OpenPCS 7 Server

SIMATIC PCS 7 OpenPCS 7 V9.1

OpenPCS 7 software for a separate OpenPCS 7 Server, based on the hardware of the SIMATIC PCS 7 Workstation, client version

6 languages (English, German, French, Italian, Spanish, Chinese), software class A, runs with Windows 10 Enterprise 2019 LTSC 64-bit, (see SIMATIC PCS 7 V9.1 Readme for the latest information), single license for 1 installation

Without SIMATIC PCS 7 Software Media Package

- Goods delivery
License key on USB flash drive, Certificate of License

6ES7658-0HX68-2YB0

- Online delivery
License key download, online Certificate of License

6ES7658-0HX68-2YH0

Note:
Email address required!

More information

To ensure safe operation of the plant, you need to take suitable security measures that also include IT security (e.g. network segmentation). You can find more information on the topic of Industrial Security on the Internet at

<http://www.siemens.com/industrial-security>

Overview



The actuator/sensor interface (AS-Interface) is a heterogeneous bus system for networking simple, usually binary actuators and sensors at the lowest field level. It is then possible to replace a cable harness with parallel wiring by a simple two-wire cable for simultaneous transmission of data and power.

The AS-Interface operates according to the master/slave principle. The AS-i master module (DP/AS-i LINK Advanced, CP 343-2, CP 343-2P, IE/AS-i LINK PN IO or communications module CM AS-i Master ST) controls the slaves (sensors/actuators) connected via AS-i cable. Up to 62 AS-Interface slaves can be operated on an AS-Interface master module.

Note:

AS-Interface is integrated as a *subordinate* bus in SIMATIC PCS 7. For further information on the AS-Interface, see Catalogs IK PI and IC 10.

Design



IE/AS-i LINK PN IO (single master and double master)

The AS-Interface can be integrated into the SIMATIC PCS 7 process control system as follows:

- Direct connection on the PROFIBUS DP via DP/AS-i LINK Advanced (AS-i single or double master)
- Connection via a CP 343-2 or CP 343-2P AS-i master module in an ET 200M remote I/O station on the PROFIBUS DP
- Direct connection on the PROFINET IO via IE/AS-i LINK PN IO (AS-i single or double master) or via ET 200SP with the CM AS-i Master ST communications module

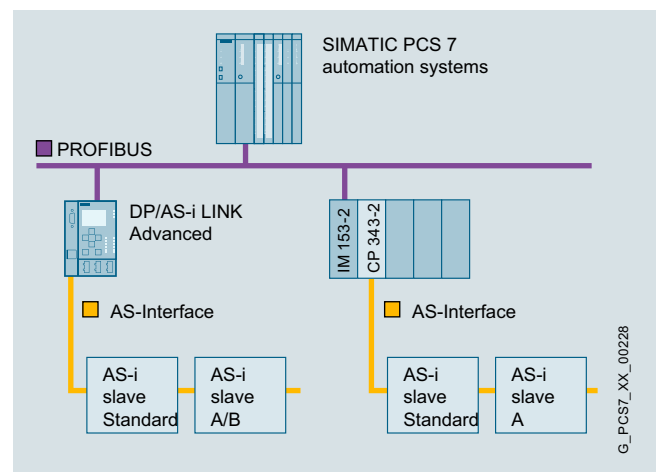

AS-i integration in SIMATIC PCS 7 via PROFIBUS DP

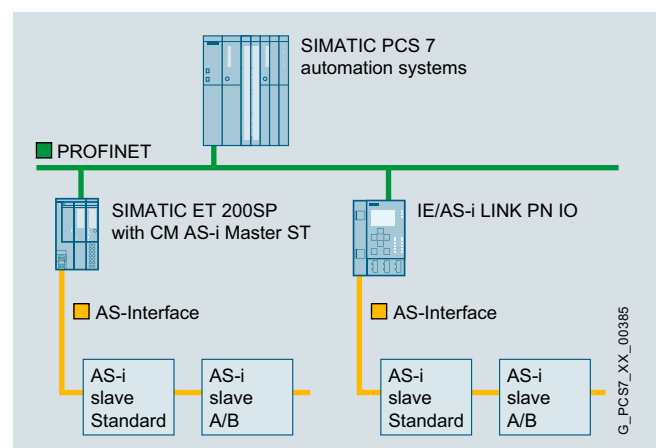

AS-i integration in SIMATIC PCS 7 via PROFINET IO

SIMATIC PCS 7 system hardware

Industrial communication

Other communication

AS-Interface

Design (continued)

System components

The basic components of a system installation are:

- AS-Interface master (alternatives):
 - DP/AS-i Link Advanced (AS-i single or double master)
 - CP 343-2 or CP 343-2P (both can be operated in an ET 200M remote I/O station)
 - IE/AS-i LINK PN IO (AS-i single or double master)
 - ET 200SP with the CM AS-i Master ST communications module
- AS-Interface block library for SIMATIC PCS 7 (add-on product, see catalog "Add-ons for SIMATIC PCS 7", chapter "Libraries/Blocks/Tools")
- AS-Interface shaped cable (use of round cable also possible if preferred)
- Modules for connecting standard sensors/actuators
- Power supply unit for powering the slaves
- Actuators and sensors with an integrated slave ASIC
- Address programming device for setting the slave address

AS-i slaves

You can use all digital AS-i standard slaves as well as digital AS-i A/B slaves in accordance with the AS-i specification V3.0. Analog AS-i slaves can also be integrated via the DP/AS-i Link Advanced or the IE/AS-i LINK PN IO.

Note:

The CP 343-2 and CP 343-2P AS-i masters transfer I/O data from AS-i slaves with a B address via data records and not via the cyclic process image (partition). To prevent delays in the communication process of the driver blocks for B slaves, it is recommended to avoid using AS-i slaves with B addresses for SIMATIC PCS 7 configurations with CP 343-2 or CP 343-2P.

Ordering data

Article No.

CM AS-i Master ST communications module

3RK7137-6SA00-0BC1

- AS-Interface master for SIMATIC ET 200SP, for plugging onto BaseUnit Type C0
- Corresponds to AS-Interface Specification V3.0
- Dimensions (W x H x D / mm): 20 x 73 x 58

DP/AS-i Link Advanced

Network transition between PROFIBUS DP and AS-Interface; master profiles M3 and M4, enhanced AS-Interface specification V3.0; IP20 degree of protection; manual on CD (English, German, French, Spanish, Italian)

- Single master with display
- Dual master with display

6GK1415-2BA10
6GK1415-2BA20

CP 343-2

Communications module for connecting SIMATIC S7-300 and ET 200M to AS-Interface; configuration of the AS-i network by means of SET key; including manual on CD (German, English, French, Spanish, Italian); without front panel connector

6GK7343-2AH01-0XA0

CP 343-2P

Communications module for the connection of SIMATIC S7-300 and ET 200M to AS-Interface; configuration of the AS-i network by means of SET key or HW Config (as of STEP 7 V5.2); including manual on CD (English, German, French, Spanish, Italian); without front connector

6GK7343-2AH11-0XA0

Front connector

20-pin, with screw contacts

6ES7392-1AJ00-0AA0

IE/AS-i LINK PN IO

Network transition between PROFINET/Industrial Ethernet and AS-Interface with IP20 degree of protection; including COMBICON plug-in screw-type terminals for connecting the AS-Interface cable

- Single master with display
- Dual master with display

6GK1411-2AB10
6GK1411-2AB20

Additional accessories

For cable material, plugs, and further accessories, see Catalog IC 10 or Industry Mall/CA 01 under "Automation engineering – Industrial Controls – Industrial Communication – AS-Interface"

Overview

CP 341 communication module

Modbus can be connected to PROFIBUS DP using an ET 200M with the CP 341 communication module. This module enables fast and efficient exchange of data through point-to-point coupling.

The CP 341 communication module is available in 3 versions with different physical transmission properties:

- RS 232C (V.24)
- 20 mA (TTY)
- RS 422/RS 485 (X.27)

The Modbus Master or Modbus Slave loadable drivers are needed for the Modbus coupling.

Ordering data**Article No.**

CP 341 communication module
With 1 RS 232 C (V.24) interface

6ES7341-1AH02-0AE0

RS 232 connecting cable
For coupling to SIMATIC S7

- 5 m
- 10 m
- 15 m

6ES7902-1AB00-0AA0

6ES7902-1AC00-0AA0

6ES7902-1AD00-0AA0

CP 341 communication module
With 1 20 mA (TTY) interface

6ES7341-1BH02-0AE0

20 mA (TTY) connecting cable
For coupling to SIMATIC S7

- 5 m
- 10 m
- 50 m

6ES7902-2AB00-0AA0

6ES7902-2AC00-0AA0

6ES7902-2AG00-0AA0

CP 341 communication module
With 1 RS 422/485 (X.27) interface

6ES7341-1CH02-0AE0

RS 422/485 connecting cable
For coupling to SIMATIC S7

- 5 m
- 10 m
- 50 m

6ES7902-3AB00-0AA0

6ES7902-3AC00-0AA0

6ES7902-3AG00-0AA0

Loadable drivers for CP 341

MODBUS master (RTU format)

- Single license
- Single license, without software and documentation

6ES7870-1AA01-0YA0

6ES7870-1AA01-0YA1

MODBUS slave (RTU format)

- Single license
- Single license, without software and documentation

6ES7870-1AB01-0YA0

6ES7870-1AB01-0YA1

SIMATIC PCS 7 system hardware

Notes

**15/2 Introduction****15/6 Centralized I/O for SIMATIC PCS 7**

- 15/6 Centralized I/O modules
- 15/7 Expansion units for centralized I/O

15/8 Power supplies

- 15/9 1-phase power supplies, 24 V DC
- 15/10 1- and 2-phase power supplies, 24 V DC
- 15/11 3-phase power supplies, 24 V DC
- 15/12 3-phase power supply system, 24 V DC
- 15/14 Add-on modules
- 15/16 SITOP DC UPS uninterruptible power supplies

15/19 SIMATIC CFU

- 15/22 SIMATIC CFU PA Edition
- 15/28 SIMATIC CFU DIQ Edition
- 15/33 BusAdapter
- 15/35 Accessories

15/36 SIMATIC ET 200SP HA

- 15/39 Interface module
- 15/41 Digital I/O modules
- 15/49 Analog I/O modules
- 15/56 Analog/digital module
- 15/59 Fail-safe I/O-modules
- 15/60 Ex I/O modules
- 15/70 Carrier modules
- 15/73 Terminal blocks
- 15/77 BusAdapter
- 15/78 Additional I/O modules

15/79 SIMATIC ET 200iSP

- 15/81 Power supply unit
- 15/83 Interface module
- 15/86 Digital electronic modules
- 15/93 Analog electronic modules
- 15/99 Safety-related electronic modules
- 15/103 Watchdog module
- 15/104 RS 485-iS coupler
- 15/106 Stainless steel wall enclosures

15/107 SIMATIC ET 200M for SIMATIC PCS 7

- 15/108 Power supply
- 15/109 Interface modules
- 15/110 Accessories
- 15/112 Bundles
- 15/113 Digital modules
- 15/118 Analog modules
- 15/121 Analog modules with HART
- 15/126 Ex digital/analog modules
- 15/131 Fail-safe digital/analog modules
- 15/133 Controller modules
- 15/135 Counter modules
- 15/136 MTA terminal modules

15/140 SIMATIC ET 200SP for SIMATIC PCS 7

- 15/143 Interface modules and BusAdapter
- 15/145 BaseUnits and I/O modules
- 15/147 Digital I/O modules
- 15/149 Analog I/O modules

15/152 SIMATIC ET 200pro for SIMATIC PCS 7

- 15/154 Interface modul IM 154-2 DP High Feature
- 15/155 Digital electronic modules EM 141, EM 142
- 15/156 Analog electronic modules EM 144, EM 145
- 15/158 Safety-related electronic modules
- 15/159 Power module PM-E
- 15/160 Power supply for ET 200pro

SIMATIC PCS 7 system hardware

Process I/O

Introduction

Overview

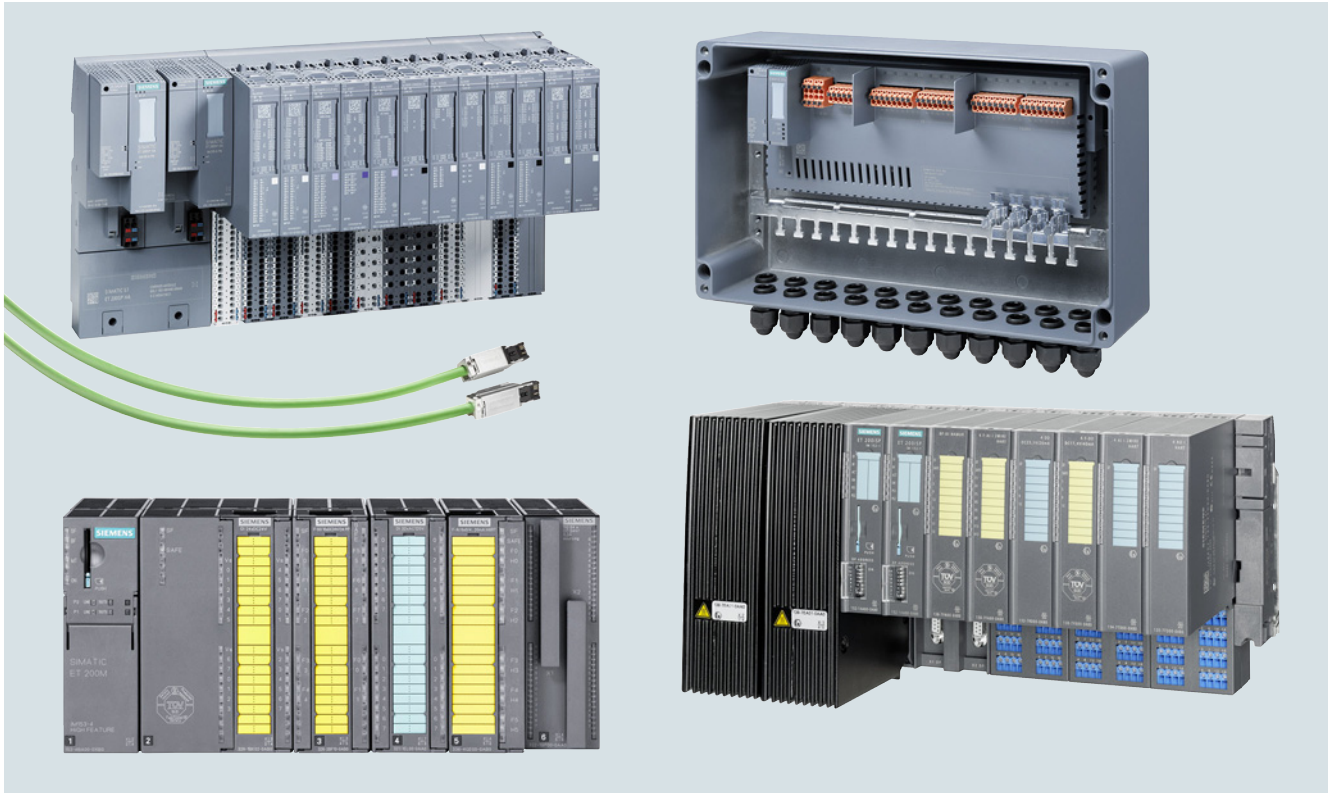

SIMATIC ET 200 remote I/O stations for SIMATIC PCS 7
(main SIMATIC ET 200SP HA, SIMATIC CFU PA, SIMATIC ET 200M and SIMATIC ET 200iSP series)

The SIMATIC PCS 7 process control system offers a variety of possibilities for detecting and outputting process signals via sensors and actuators as well as for connecting process I/O to the automation systems:

- Signal and function modules in remote I/O stations on the fieldbus
 - PROFIBUS DP (ET 200M, ET 200iSP, ET 200pro)
 - PROFINET IO (ET 200SP HA, SIMATIC CFU, ET 200M, ET 200SP)
- Analog and digital I/O modules of the SIMATIC S7-400 operated centrally in the automation system

SIMATIC S7-400 signal modules used centrally in the automation system are suitable for small applications or plants with few remote locations. In practice, however, distributed process I/Os are mainly used which, depending on the type, also support redundant configurations or operation in explosive gas/dust atmospheres:

- SIMATIC ET 200 remote I/Os in conjunction with classic field/process devices and HART field devices
- Intelligent field/process devices for direct fieldbus connection

Especially convincing arguments for distributed process I/O include:

- Modularity and consistency
- Flexible adaptability to the plant structure
- Minimum cabling and engineering requirements
- Low commissioning, service and life cycle costs
- Wide technical bandwidth

Design

Comparison of distributed I/O systems for SIMATIC PCS 7



Design

Degree of protection	IP20	IP20	IP30	IP20	IP20	IP65/IP66/IP67
Design	Compact	Modular	Modular	Modular	Discretely scalable	Modular
Assembly	Mounting rail	Mounting rail	Mounting rail	Mounting rail	Standard mounting rail	Mounting rail
Connection system for sensors/actuators	Multi-wire connection Screw-type connection	Multi-wire connection Push-in terminals	Multi-wire connection Spring-loaded/screw-type connections	Single-wire connection Spring-loaded/screw-type connections, FastConnect, TopConnect	Single/multi-conductor connection Push-in terminals	M8, M12, M23

Special applications

Safety engineering	–	–	●	●	–	●
For use in hazardous areas	Zones 2, 22	Zone 2	Zones 1, 21	Zone 2	Zone 2	–
Increased availability	Redundant	Switched, redundant	Switched, redundant	Switched, redundant	–	–
Temperature range	-40 ... +70 °C (horizontal)	-40 ... +70 °C (horizontal)	-20 ... +70 °C (horizontal)	0 ... +60 °C ¹⁾ (horizontal)	0 ... +60 °C ¹⁾ (horizontal)	-25 ... +55 °C (horizontal)
Vibration resistance (continuous)	1 g	1 g	1 g	1 g	Up to 5 g	5 g (module-dependent)

Communication

PROFIBUS (Cu/FO)	– / –	– / –	● / – (1.5 Mbps)	● / – (12 Mbps)	● / –	● / ● (12 Mbps)
PROFINET (Cu/FO)	● / ●	● / ●	– / –	● / –	● / ●	– / –

System functions

Permanent wiring	●	●	●	● (insertion and removal)	●	–
Hot swapping	–	●	●	● (with active backplane bus)	●	●
Expansion/configuration during ongoing operation	● / ●	● / ●	● / ●	● / ●	– / –	– / –
Diagnostics (module-dependent)	Channel-discrete	Channel-discrete	Channel-discrete	Channel-discrete	Channel-discrete	Channel-discrete

Functions

Digital channels	●	●	●	●	●	●
Analog channels	●	●	●	●	●	●
incl. HART	PROFIBUS PA	●	●	●	●	–
Motor starter	–	Available soon	–	–	–	–
Pneumatic interface	–	Available soon	●	–	–	–
Technological functions	Available soon	Available soon	Counting, frequency measuring	Counting/measuring, controlling, weighing	–	–

¹⁾ Also available as SIPLUS component for expanded temperature range -25/-40 ... +60/+70 °C and corrosive atmosphere/condensation (details at: <http://www.siemens.com/siplus>)

SIMATIC PCS 7 system hardware

Process I/O

Introduction

Design (continued)

Integration of process I/O in the hazardous area

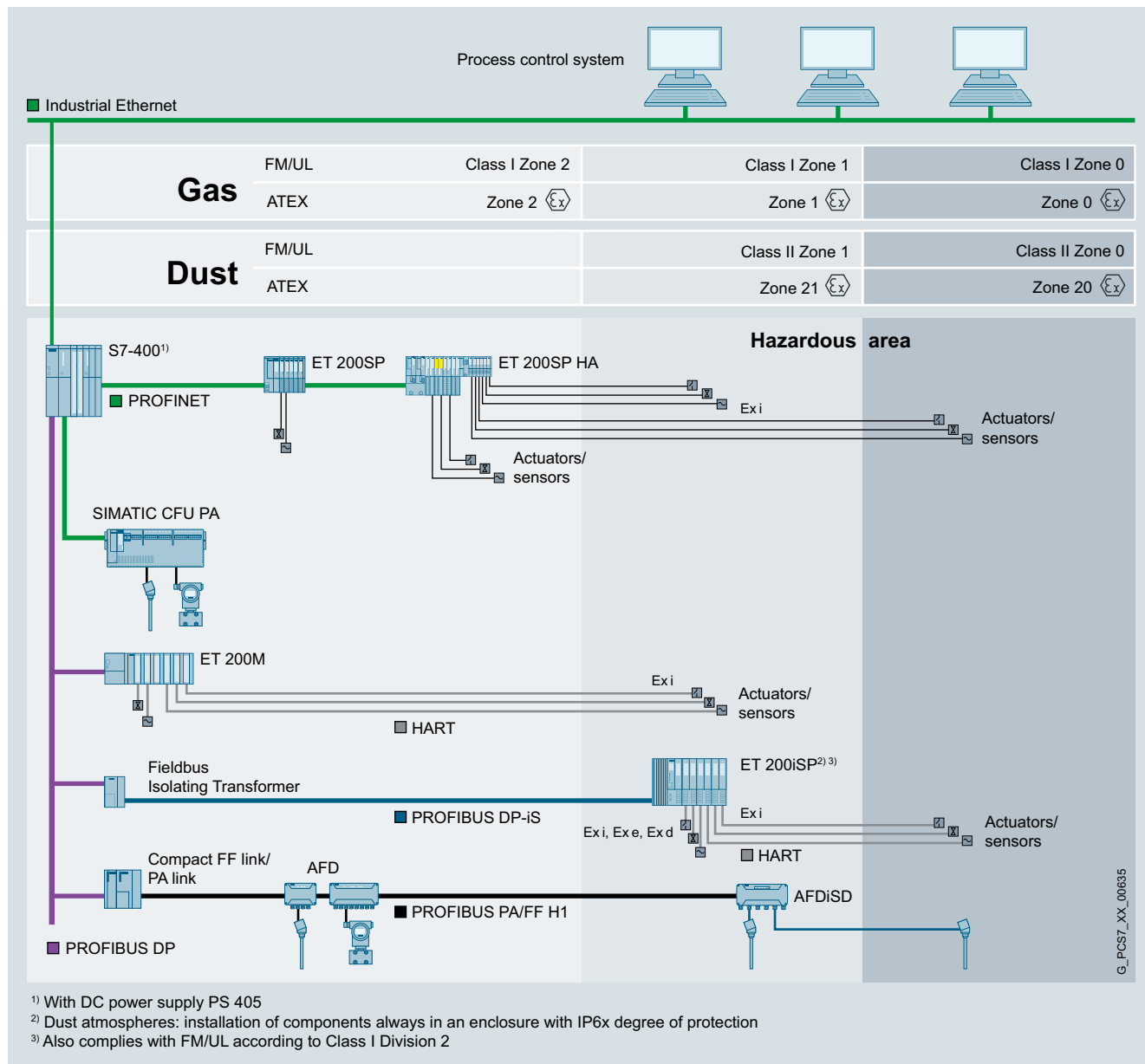

Process I/O in explosive gas and dust atmospheres

The figure shows the possible applications for the SIMATIC PCS 7 process I/O with consideration of different environmental conditions.

Field devices on the PROFIBUS PA or FOUNDATION Fieldbus H1

Field devices located in Ex zones 0, 1, 2, 20, 21 or 22 can be integrated in SIMATIC PCS 7 via various active field distributors on the PROFIBUS PA or FOUNDATION Fieldbus H1. The active field distributor AFDiSD is required for field devices in Ex zones 0, 1, 20 or 21.

ET 200iSP distributed I/O

ET 200iSP remote I/O stations suitable for gas/dust atmospheres can be installed directly in the Ex zones 1, 2, 21 or 22 as well as in non-hazardous areas. The intrinsically-safe sensors, actuators and HART field devices can also be located in zone 0 or 20 if necessary.

ET 200M, ET 200SP und ET 200SP HA distributed I/O

ET 200M, ET 200SP and ET 200SP HA remote I/O stations can be used in Ex zone 2 as well as in non-hazardous areas. The actuators/sensors can also be positioned in Ex zone 1 or 21. Special Ex I/O modules are available for this in the ET 200M product range.

Design (continued)ET 200pro distributed I/O

ET 200pro remote I/O stations are designed for use in non-hazardous areas.

Intrinsically-safe operator panel

An intrinsically-safe operator panel can be used in hazardous areas, zone 1, 2, 21 or 22, if required. For further information on this operator panel, see under SIMATIC HMI Thin Client Ex in the Catalog "Add-ons for the SIMATIC PCS 7 process control system", Section "Operator control and monitoring".

Function**Possible online modifications among the process I/Os**

Remote I/O	PROFIBUS DP	PROFINET
SIMATIC ET 200SP HA		<ul style="list-style-type: none"> • Adding ET 200SP HA stations • Adding I/O modules to the station • Changing the parameter settings of I/O modules • Configuration of connected HART field devices with SIMATIC PDM
SIMATIC CFU		<ul style="list-style-type: none"> • Adding CFU • Adding field devices to CFU • Changing the parameter settings of the CFU and connected PROFIBUS PA field devices over SIMATIC PDM
SIMATIC ET 200M	<ul style="list-style-type: none"> • Adding of ET 200M stations • Adding of I/O modules to the station • Changing the parameter settings of I/O modules • Parameterization of connected HART field devices with SIMATIC PDM 	
SIMATIC ET 200iSP	<ul style="list-style-type: none"> • Adding of ET 200iSP stations • Adding of modules for the station • Re-configuration of modules • Parameterization of connected HART field devices using SIMATIC PDM 	
SIMATIC ET 200pro	<ul style="list-style-type: none"> • Adding of ET 200pro stations 	
PROFIBUS DP, PROFIBUS PA, FOUNDATION Fieldbus H1	<ul style="list-style-type: none"> • Adding of PROFIBUS DP stations • Adding of PA links and PA field devices • Parameterization of PA or FF field devices with SIMATIC PDM 	

More information

For special blocks and block libraries for integration of field/process devices in SIMATIC PCS 7, e.g. devices from drive and weighing systems, see the Industry Mall as well as Catalog ST PCS 7 AO, "Add-ons for the SIMATIC PCS 7 Process Control System".

For information and ordering data on field/process devices, drive and motor management systems from Siemens, see the Industry Mall as well as the PDF versions of the corresponding catalogs on the Internet.

SIMATIC PCS 7 system hardware

Process I/O

Centralized I/O for SIMATIC PCS 7

Centralized I/O modules

Overview



Signal modules from the SIMATIC S7-400 range can be used in the SIMATIC PCS 7 automation system if necessary. These are primarily an alternative to use of distributed I/Os in the case of small applications or systems with a small distributed configuration.

For SIMATIC PCS 7, the I/O modules listed in the Ordering data have been selected from the range of S7-400 signal modules.

Notes:

Apart from these selected modules it is also possible to use - with limitations in functions - all other I/O modules from the current range of S7-400 signal modules.

All process data from the I/O are available for PCS 7 engineering in the CFC, and can be graphically interconnected to the signal name in the signal list. Diagnostics information is generated automatically when using the I/O modules listed here.

When using other I/O modules, integration in SIMATIC PCS 7 is limited to the process data, i.e. the full scope of diagnostics functions is not automatically available. These modules can therefore only be used meaningfully in SIMATIC PCS 7 if the diagnostics capability can be omitted.

Online modifications and redundancy are not supported by the central I/O.

Ordering data

Article No.

SM 421 Digital Input Modules

- 32 inputs, 24 V DC
- 32 inputs, 120 V AC/DC
- 16 inputs, 24 V DC, with process/diagnostics interrupt
- 16 inputs, 24 to 60 V AC/DC, with process/diagnostics interrupt
- 16 inputs, 120/230 V AC/DC, inputs according to IEC 1131-2 Type 2

6ES7421-1BL01-0AA0
6ES7421-1EL00-0AA0
6ES7421-7BH01-0AB0
6ES7421-7DH00-0AB0
6ES7421-1FH20-0AA0

SM 422 Digital Output Modules

- 32 outputs; 24 V DC, 0.5 A
- 32 outputs; 24 V DC, 0.5 A; with diagnostics
- 16 outputs; 24 V DC, 2 A
- 16 outputs; relay contacts
- 16 outputs; 120/230 V AC, 2 A

6ES7422-1BL00-0AA0
6ES7422-7BL00-0AB0
6ES7422-1BH11-0AA0
6ES7422-1HH00-0AA0
6ES7422-1FH00-0AA0

SM 431 Analog Input Modules

- 16 inputs, non-floating, 13 bit
- 8 inputs, floating, 13 bit
- 8 inputs, floating, 14 bit, with linearization (RTD/TC)
- 8 inputs, floating, 14 bit
- 16 inputs, floating, 16 bit; hardware interrupt capability, with diagnostics interrupt
- 8 inputs, floating, 16 bit; hardware interrupt capability, for thermocouples, with diagnostics interrupt
- 8 inputs, floating, 16 bit; hardware interrupt capability, for thermal resistors, with diagnostics interrupt

6ES7431-0HH00-0AB0
6ES7431-1KF00-0AB0
6ES7431-1KF10-0AB0
6ES7431-1KF20-0AB0
6ES7431-7QH00-0AB0
6ES7431-7KF00-0AB0
6ES7431-7KF10-0AB0

SM 432 Analog Output Modules

- 8 outputs, floating, 13 bit; for ± 10 V, 0 to 10 V, 1 to 5 V, ± 20 mA, 0 to 20 mA, 4 to 20 mA

6ES7432-1HF00-0AB0

Front Connector (1 unit)

- With screw contacts
- With spring clamps
- With crimp contacts

6ES7492-1AL00-0AA0
6ES7492-1BL00-0AA0
6ES7492-1CL00-0AA0

Technical specifications

You can find the detailed technical data of the S7-400 modules at the following points:

- Catalog ST 400 or
- Industry Mall/CA 01 under "Automation technology – Automation systems – SIMATIC industrial automation systems – Controllers – Advanced Controller – S7-400/S7-400H/S7-400F/FH"

Overview

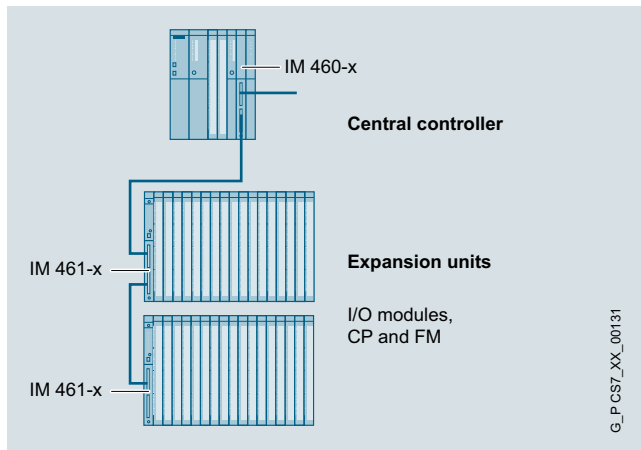

Expansion units can be used for the distributed expansion of the SIMATIC S7-400. The IM 460-x interface modules are used as the interface for these expansion units.

Limitation compared to standard input/output modules of ET 200M

- No redundant interfacing of expansion units
- No configuration during operation

Racks

The universal racks (UR) are used for SIMATIC PCS 7. They can be used as central racks and as expansion racks. For other racks, see Catalog ST 400.

Ordering data

Article No.

IM 460-0 interface module

6ES7460-0AA01-0AB0

- Transmitter module for central controller
- Without transmission of voltage to the expansion unit
- Cable up to 5 m long
- With K-bus for communication with CPs and FMs in the expansion unit
- For connecting as many as 8 expansion units

IM 461-0 Interface Module

6ES7461-0AA01-0AA0

Corresponding receiver module for the expansion unit

IM 460-1 Interface Module

6ES7460-1BA01-0AB0

- Transmitter module for central controller
- With transmission of the 5 V supply for I/O modules
- Cable up to 1.5 m long
- Without transmission of the K-bus, hence solely for communication from I/O modules

IM 461-1 Interface Module

6ES7461-1BA01-0AA0

Corresponding receiver module for the expansion unit

IM 460-3 Interface Module

6ES7460-3AA01-0AB0

- Transmitter module for central controller
- Without transmission of voltage to the expansion unit
- Cable up to 100 m long
- With K-bus for communication with CPs and FMs in the expansion unit
- For connecting as many as 8 expansion units

IM 461-3 Interface Module

6ES7461-3AA01-0AA0

Corresponding receiver module for the expansion unit

UR1 rack

6ES7400-1TA01-0AA0

- for central and expansion units
- 18 slots
 - Suitable for redundant power supply

UR2 rack

6ES7400-1JA01-0AA0

- for central and expansion units
- 9 slots
 - Suitable for redundant power supply

Accessories**468-1 Connecting Cable**

for connecting IM 460-0 and IM 461-0; IM 460-3 and IM 461-3

- 0.75 m
- 1.5 m
- 5 m

6ES7468-1AH50-0AA0
6ES7468-1BB50-0AA0
6ES7468-1BF00-0AA0

Additional lengths for connecting IM 460-3 and IM 461-3

- 10 m
- 25 m
- 50 m
- 100 m

6ES7468-1CB00-0AA0
6ES7468-1CC50-0AA0
6ES7468-1CF00-0AA0
6ES7468-1DB00-0AA0

Terminator

for IM 461-0

6ES7461-0AA00-7AA0

468-3 Connecting Cable

for connecting IM 460-1 and IM 461-1

- 0.75 m
- 1.5 m

6ES7468-3AH50-0AA0
6ES7468-3BB50-0AA0

SIMATIC PCS 7 system hardware

Process I/O

Power supplies

Overview



SITOP modular

A reliable 24-V power supply is a basic condition for every plant operation. With MTBF ratings of up to 1 million hours at full load in continuous operation, SITOP power supplies meet the particularly stringent requirements for process automation.

For world-wide use, the single-phase, 2-phase or 3-phase DIN rail devices provide a wide ambient temperature range of -25 ... +70 °C as well as comprehensive international approvals such as ATEX, Class I Div2, IECex or GL.

The innovative SITOP PSU8600 power supply system can be fully integrated in the plant via PROFINET and thereby offers completely new configuration and diagnostic capabilities. It is thus possible to individually adjust and monitor the voltage and current of each output. For the first time, users have access to information about the control circuit including energy flow data.



SITOP add-on modules and UPS1600

24-V power units with output capacities up to 1000 W can be individually adapted to the plant configuration and plant expansion and combined with redundancy, selectivity or DC USP modules. This means that you can expand the system to even include complete all-round protection.

The SITOP library is available with blocks and faceplates for direct integration into SIMATIC PCS 7. This means that PCS 7 users automatically receive information about operating states, maintenance requirements (e.g. battery replacement) and faults (e.g. power failure, short-circuit or overload in 24V circuits).

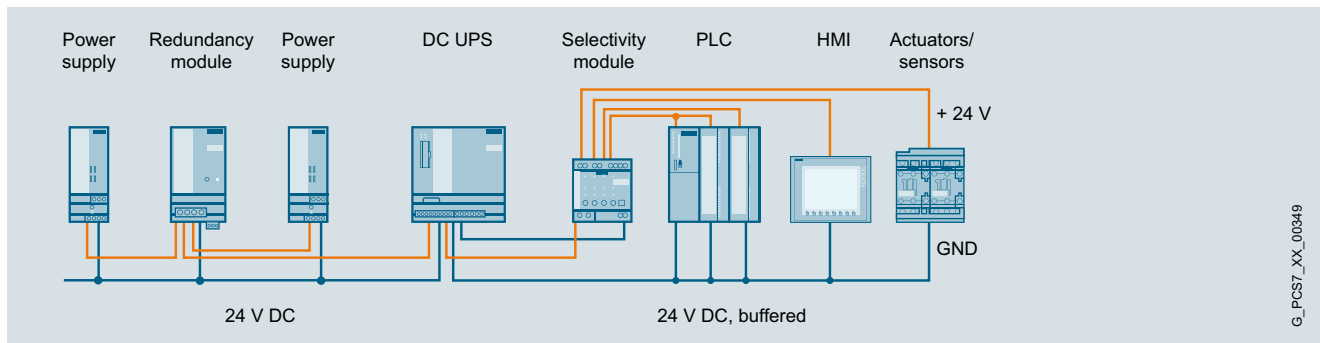

24 V DC power supply with add-on modules and DC UPS

More information

You can find detailed information and technical specifications for the 1-phase, 2-phase and 3-phase SITOP modular power supplies, for the SITOP PSU8600 power supply system, for the redundancy, buffer and selectivity modules, as well as for corresponding 24 V DC uninterruptible power supplies in the Catalog KT 10.1.

Additional information is available via the Internet at:

- SITOP power supplies:
<http://www.siemens.com/sitop>
- CAx data (2D, 3D, circuit diagram macros):
<http://www.siemens.com/sitop-cax>
- Operating instructions:
<http://www.siemens.com/sitop/manuals>

SITOP Selection Tool

The SITOP Selection Tool helps you select the power supply and DC UPS for your specific application easily and quickly:
<http://www.siemens.com/tst>

SITOP library for SIMATIC PCS 7

SIMATIC PCS 7 V8.0 with SP2, V8.1, V8.1 with SP1, V8.2 are supported.

<https://support.industry.siemens.com/cs/ww/en/view/109476154>

SIMATIC PCS 7 Standard Architectures manual (chapter 18, 24 V DC supply concepts)

<https://support.industry.siemens.com/cs/ww/en/view/109739629>

Application example: Integration of a SITOP 24V power supply in SIMATIC PCS 7

<https://support.industry.siemens.com/cs/ww/en/view/109481908>



G_PCS7_XX_00349

Overview

SITOP PSU8200 1-phase, 24 V, 10 A

- 24 V DC/5 A, 10 A, 20 A and 40 A
- 1-phase wide-range input allows connection to any supply system and ensures safety in the case of voltage supply deviations
- Extremely slim design – no lateral installation clearances required
- Power Boost with 3 times the rated current (for 25 ms) for tripping protective devices
- Extra power with 1.5 times the rated current (5 s/min) for brief, operational overload
- Optional short-circuit behavior between constant current and restart
- Optional symmetrical load distribution for parallel operation
- Operating status display on 3 LEDs
- Extremely high efficiency up to 94%
- Large temperature range from -25 °C to +70 °C
- Comprehensive certifications, such as cULus, ATEX, IECEx or GL
- Direct integration in SIMATIC PCS 7 via SITOP library

Design**Product overview**

Modules	Versions	Input	Output	
Power supplies				
	SITOP modular, 1-phase, 24 V DC	PSU8200, 5 A	120/230 V AC	24 V DC, 5 A
		PSU8200, 10 A	120/230 V AC	24 V DC, 10 A
	SITOP modular, 1-phase, 24 V DC	PSU8200, 20 A	120 ... 230 V AC/DC	24 V DC, 20 A
		PSU8200, 40 A	120/230 V AC	24 V DC, 40 A

Ordering dataSITOP modular power supplies,
1-phase, 24 V DC**SITOP PSU8200, 1-phase,
24 V DC, 5 A**Stabilized power supply
Input: 120/230 V AC
Output: 24 V DC/5 A**SITOP PSU8200, 1-phase,
24 V DC, 10 A**Stabilized power supply
Input: 120/230 V AC
Output: 24 V DC/10 A**Article No.****6EP3333-8SB00-0AY0****6EP3334-8SB00-0AY0****Article No.****SITOP PSU8200, 1-phase,
24 V DC, 20 A**Stabilized power supply
Input: 120 ... 230 V AC /
110 ... 220 V DC
Output: 24 V DC/20 A**SITOP PSU8200, 1-phase,
24 V DC, 40 A**Stabilized power supply
Input: 120/230 V AC
Output: 24 V DC/40 A**6EP1336-3BA10****6EP3337-8SB00-0AY0**

SIMATIC PCS 7 system hardware

Process I/O

Power supplies

1- and 2-phase power supplies, 24 V DC

Overview



SITOP PSU200M 24 V, 10 A

- 24 V DC/5 A and 10 A, also available as version with PCB with protective coating.
- 1-phase and 2-phase ultra-wide input range
- Extremely slim design – no lateral installation clearances required
- Power Boost with 3 times the rated current (for 25 ms) for tripping protective devices
- Extra power with 1.5 times the rated current (5 s/min) for brief, operational overload
- Optional short-circuit behavior between constant current and restart
- Optional symmetrical load distribution for parallel operation
- Operating status display on 3 LEDs
- High degree of efficiency of up to 91%
- Large temperature range from -25 °C to +70 °C
- Comprehensive certifications, such as cULus, ATEX, IECEx or GL
- Direct integration in SIMATIC PCS 7 via SITOP library

Design

Product overview

Modules	Versions	Input	Output	
Power supplies				
	SITOP modular, 1-phase and 2-phase, 24 V DC	PSU200M, 5 A	120/230 ... 500 V AC	24 V DC, 5 A
		PSU200M, 10 A	120/230 ... 500 V AC	24 V DC, 10 A
	SITOP modular PLUS, 1-phase and 2-phase, 24 V DC, with protective coating	PSU200M, 5 A	120/230 ... 500 V AC	24 V DC, 5 A
		PSU200M, 10 A	120/230 ... 500 V AC	24 V DC, 10 A

Ordering data

Article No.



SITOP modular power supplies, 1-phase and 2-phase, 24 V DC	
SITOP PSU200M, 1-phase and 2-phase, 24 V DC, 5 A Stabilized power supply Input: 120 ... 230 V / 230 ... 500 V AC Output: 24 V DC/5 A	6EP1333-3BA10
SITOP PSU200M PLUS, 1-phase and 2-phase, 24 V DC, 5 A Stabilized power supply Input: 120 ... 230 V / 230 ... 500 V AC Output: 24 V DC/5 A Version with protective coating	6EP1333-3BA10-8AC0
SITOP PSU200M, 1-phase and 2-phase, 24 V DC, 10 A Stabilized power supply Input: 120 ... 230 V / 230 ... 500 V AC Output: 24 V DC/10 A	6EP1334-3BA10
SITOP PSU200M PLUS, 1-phase and 2-phase, 24 V DC, 10 A Stabilized power supply Input: 120 ... 230 V / 230 ... 500 V AC Output: 24 V DC/10 A Version with protective coating	6EP1334-3BA10-8AB0

Overview

SITOP PSU8200 3-phase, 24 V, 20 A

- 24 V DC/20 A and 40 A
- 3-phase wide-range input from 320 to 575 V AC for global use
- Extremely slim design – no lateral installation clearances required
- Power Boost with 3 times the rated current (for 25 ms) for tripping protective devices
- Extra power with 1.5 times the rated current (5 s/min) for brief, operational overload
- Optional short-circuit behavior between constant current and restart
- Optional symmetrical load distribution for parallel operation
- Operating status display on 3 LEDs
- Extremely high efficiency up to 94%
- Large temperature range from -25 °C to +70 °C
- Comprehensive certifications, such as cULus, ATEX, IECEx and GL
- Direct integration in SIMATIC PCS 7 via SITOP library

Design**Product overview**

Modules	Versions	Input	Output
Power supplies			
	SITOP modular, 3-phase, 24 V DC	PSU8200, 20 A	3 AC 400 ... 500 V 24 V DC, 20 A
		PSU8200, 40 A	3 AC 400 ... 500 V 24 V DC, 40 A

Ordering data**Article No.****SITOP modular power supplies, 3-phase, 24 V DC****SITOP PSU8200, 3-phase, 24 V DC, 20 A**

Stabilized power supply
Input: 3 AC 400 ... 500 V
Output: 24 V DC/20 A

6EP3436-8SB00-0AY0**SITOP PSU8200, 3-phase, 24 V DC, 40 A**

Stabilized power supply
Input: 3 AC 400 ... 500 V
Output: 24 V DC/40 A

6EP1437-3BA10

SIMATIC PCS 7 system hardware

Process I/O

Power supplies

3-phase power supply system, 24 V DC

Overview



The unique SITOP PSU8600 power supply system sets new standards for industrial power supplies. Voltage and current response thresholds can be set individually for each output of this power supply system. Selective monitoring of each output for overload also enables fast fault location. Depending on requirements, additional modules from the modular system can be added without wiring overhead, for example, to buffer against transient power failures.





Comprehensive diagnostic and maintenance information is available via PROFINET and can be evaluated and visualized directly in SIMATIC PCS 7. Optimal support is also provided for energy management of a plant: From the acquisition of energy data from individual outputs, the specific activation and deactivation of outputs via PROFIenergy, to direct integration in power management systems.

Special features

- Reduced space requirement and costs due to multiple integrated outputs with selective monitoring
- Individually configurable outputs (voltage from 5 V to 28 V, power response threshold value from 0.5 A to 5 A or 10 A)
- Compensation for power losses can be set separately for each output
- Narrow width without lateral installation clearances
- Low temperature rise in the control cabinet due to very high efficiency
- Two integrated Ethernet/PROFINET ports (no external switch required)
- OPC UA Server functionality for parameter assignment and data communication
- Can be added without wiring overhead (more outputs, buffer module for bridging transient power failures)
- Preventive maintenance reduces downtimes
- Energy savings during breaks through targeted switching of outputs (via STEP 7 program or PROFIenergy profile)
- SIMATIC S7 function blocks for easy integration in STEP 7 user programs and faceplates for operator control and monitoring.
- Direct integration in SIMATIC PCS 7 via SITOP library

Design

Product overview

Modules		Versions	Input	Output
PSU8600 basic units				
	SITOP power supply system, 3-phase, 24 V DC	PSU8600, 20 A	3 AC 400 to 500 V	24 V DC, 20 A
		PSU8600, 40 A	3 AC 400 to 500 V	24 V DC, 40 A
		PSU8600, 20 A/5 x 4 A	3 AC 400 to 500 V	24 V DC, 20 A/4 x 5 A
		PSU8600, 40 A/5 x 10 A	3 AC 400 to 500 V	24 V DC, 40 A/4 x 10 A
CNX8600 for expanding outputs				
	SITOP CNX8600 4 x 5 A expansion module	CNX8600, 4 x 5 A	24 V DC	24 V DC, 4 x 5 A
	SITOP CNX8600 4 x 10 A expansion module	CNX8600, 4 x 10 A	24 V DC	24 V DC, 4 x 10 A
BUF8600 buffer				
	SITOP BUF8600 buffer module	BUF8600, 100 ms/40 A BUF8600, 300 ms/40 A BUF8600, 4 s/40 A BUF8600, 10 s/40 A	24 V DC	24 V DC, 40 A

Ordering data

Ordering data	Article No.	Ordering data	Article No.
SITOP PSU8600 3-phase, 24 V DC/20 A with PN/IE connection Stabilized power supply Input: 3 AC 400 ... 500 V Output: 24 V DC/20 A	6EP3436-8SB00-2AY0	SITOP CNX8600 4 x 5 A expansion module For SITOP PSU8600 Output: 24 V DC / 4 x 5 A	6EP4436-8XB00-0CY0
SITOP PSU8600 3-phase, 24 V DC/40 A with PN/IE connection Stabilized power supply Input: 3 AC 400 ... 500 V Output: 24 V DC/40 A	6EP3437-8SB00-2AY0	SITOP CNX8600 4 x 10 A expansion module For SITOP PSU8600 Output: 24 V DC / 4 x 10 A	6EP4437-8XB00-0CY0
SITOP PSU8600 3-phase, 24 V DC/20 A/4 x 5 A with PN/IE connection Stabilized power supply Input: 3 AC 400 ... 500 V Output: 24 V DC/20 A	6EP3436-8MB00-2CY0	SITOP BUF8600 100 ms buffer module For SITOP PSU8600 Buffer capacity 100 ms/40 A	6EP4297-8HB00-0XY0
SITOP PSU8600 3-phase, 24 V DC/40 A/4 x 10 A with PN/IE connection Stabilized power supply Input: 3 AC 400 ... 500 V Output: 24 V DC / 40 A/4 x 10 A	6EP3437-8MB00-2CY0	SITOP BUF8600 300 ms buffer module For SITOP PSU8600 Buffer capacity 300 ms/40 A	6EP4297-8HB10-0XY0
		SITOP BUF8600 4 s buffer module For SITOP PSU8600 Buffer capacity 4 s/40 A	6EP4293-8HB00-0XY0
		SITOP BUF8600 10 s buffer module For SITOP PSU8600 Buffer capacity 10 s/40 A	6EP4295-8HB00-0XY0
		Device labeling plates	3RT1900-1SB20

SIMATIC PCS 7 system hardware

Process I/O

Power supplies

Add-on modules

Overview

Redundancy modules

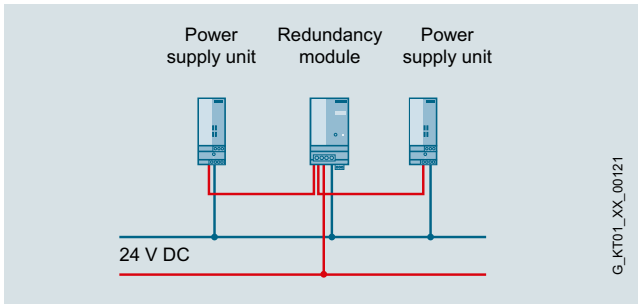

SITOP redundancy modules

- High availability of the 24 V DC supply thanks to redundant configuration
- Decoupling of two power supplies of the same type in parallel operation via diodes
- 24 V DC power supply is maintained in the event of a power failure
- Compact redundancy modules for power supply units up to 40 A
- Diagnostic signal via LED and signaling contacts
- Adjustable switching threshold for LED and signaling contacts
- Direct integration in SIMATIC PCS 7 via SITOP library

Buffer module

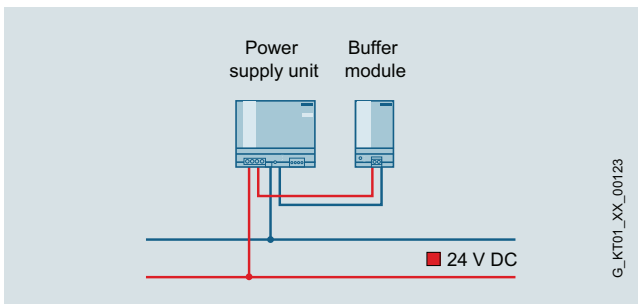

SITOP buffer module

- Buffering the load current during brief power interruptions
- Maintenance-free capacitors with short charging times as energy storage units
- Wiring parallel to the output of the power supply
- Parallel switching of several buffer modules possible
- A supply voltage > 20.5 V is signaled by an LED on the device.
- Buffer time up to: 200 ms at 40 A, 400 ms at 20 A, 800 ms at 10 A, 1.6 s at 5 A load current

Selectivity modules

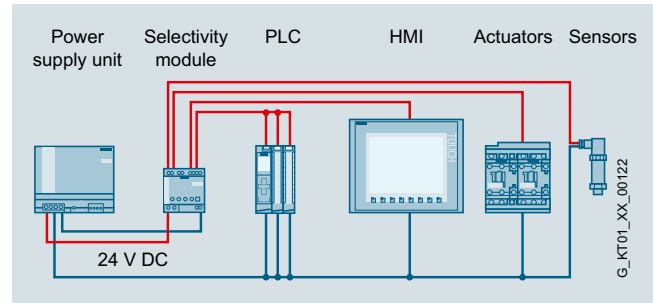



SITOP selectivity modules

- Distribution of the load current over up to 4 current circuits with individually adjustable maximum current
- Monitoring of individual partial currents
- Reliable tripping regardless of cable lengths and cross-sections
- Selective cutoff of current circuits at overload or short-circuit
- Simple commissioning thanks to manual switch on/off of outputs
- Sequential connection delay of feeders reduces total inrush current
- Sealable transparent cover over adjusters for currents and times protect against maladjustment
- Remote reset possible from a central location
- Signaling via LEDs (channel-by-channel) and remote diagnostics via common signaling contact or single-channel signaling
- Evaluation of the status of 4 current circuits of selectivity modules with single-channel signaling via SIMATIC S7 function blocks.
- Direct integration in SIMATIC PCS 7 via SITOP library

Design

Product overview

Modules		Versions	Input	Output
Redundancy modules				
	SITOP redundancy module PSE202U	24 V DC, 40 A	24 V DC	U_e – approx. 0.5 V
		24 V DC, 10 A	24 V DC	U_e – approx. 0.5 V
Buffer module				
	SITOP buffer module	--	24 V DC	U_e - approx. 1 V
Selectivity modules				
	SITOP selectivity module PSE200U, 3 A, 4-channel, 4 × 3 A Adjustable output current: 0.5 ... 3 A	With common signal contact	24 V DC	U_e - approx. 0.2 V
		NEC Class 2 with common signal contact		
		With single-channel signaling	24 V DC	
		NEC Class 2 with single- channel signaling		
SITOP selectivity module PSE200U, 10 A, 4-channel, 4 × 10 A Adjustable output current: 3 ... 10 A	Without single-channel signaling (common signaling contact)	24 V DC	U_e - approx. 0.2 V	
	With single-channel signaling			

Ordering data

Add-on modules for
SITOP modular power supplies

Redundancy modules

Redundancy module
SITOP PSE202U, 24 V DC/40 A

Suitable for decoupling two
SITOP power supplies each with
a maximum of 20 A output current

Input: 24 V DC
Output: U_e - approx. 0.5 V

Redundancy module
SITOP PSE202U, 24 V DC/10 A

Suitable for decoupling two SITOP
power supplies each with
a maximum of 5 A output current

Input: 24 V DC
Output: U_e - approx. 0.5 V

Buffer module

SITOP PSE201U buffer module

For SITOP modular and SITOP
smart buffer time 100 ms to 10 s,
depending on load current

Input: 24 V DC
Output: U_e - approx. 1 V

Article No.

6EP1961-3BA21

6EP1964-2BA00

6EP1961-3BA01

Article No.

Selectivity modules

SITOP PSE200U selectivity
module, 3 A

4-channel (4 × 3 A)

Input: 24 V DC
Output: U_e – approx. 0.2 V
Adjustable output current 0.5 to 3 A

- With common signal contact
- NEC Class 2 with common
signal contact
- With single-channel signaling
- NEC Class 2 with single-channel
signaling

6EP1961-2BA11
6EP1961-2BA516EP1961-2BA31
6EP1961-2BA61SITOP PSE200U selectivity
module, 10 A

4-channel (4 × 10 A)

Input: 24 V DC
Output: U_e – approx. 0.2 V
Adjustable output current 3 to 10 A

- Without single-channel signaling
(common signaling contact)
- With single-channel signaling

6EP1961-2BA21

6EP1961-2BA41

SIMATIC PCS 7 system hardware

Process I/O

Power supplies

SITOP DC UPS uninterruptible power supplies

Overview

SITOP DC UPS with capacitors

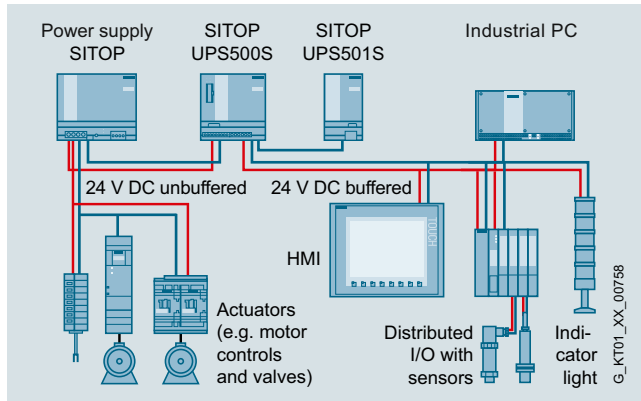

- Buffering of 24 V DC up to 15 A
- Buffering of power failures for up to several minutes enables data backup and controlled shutdown
- Ambient temperatures up to +60 °C
- Short charging times
- Maintenance-free operation and long lifetime, also at high temperatures
- Status messages via LEDs and floating signaling contacts
- Communication with controller/IPC via USB
- Extension of the buffer time with up to 3 expansion modules

SITOP UPS1600 DC UPS modules with UPS1100 battery modules

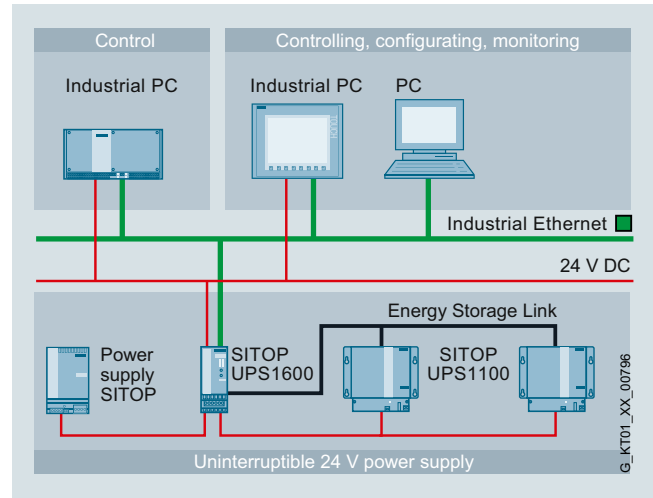

- High-performance DC UPS modules in space-saving, slim design
- 24 V DC buffering for a few hours for the purpose of continuing processes
- High overload capability for mains and buffer mode
- Starting from the battery module supports stand-alone mode, e.g. for starting generators
- Open communication via USB or two Ethernet/ PROFINET ports; OPC UA Server functionality for parameter assignment and data communication
- Easy configuration thanks to automatic detection of battery modules
- High reliability and availability due to monitoring of the operational readiness, battery feed, aging and charging status
- Battery-saving charging due to temperature-specific charging characteristic
- Defined shutdown of several IPCs or controllers on one UPS (versions with Ethernet/PROFINET)
- Remote monitoring via integrated web server (versions with Ethernet/PROFINET)
- SIMATIC S7 function blocks for easy integration in STEP 7 user programs and faceplates for operator control and monitoring.
- Direct integration in SIMATIC PCS 7 via SITOP library

The intelligent UPS1600 battery management charges the UPS1100 with the optimal, temperature-controlled charging characteristics and monitors the status (operating data and diagnostic information) of the connected battery modules via the energy storage link. For longer backup times, up to six same type battery modules can be connected in parallel.

Design

Product overview

Modules	Versions	Input	Output	
Uninterruptible 24 V DC power supplies				
SITOP DC UPS with capacitors				
	SITOP DC UPS basic device UPS500S, 15 A, IP20, can be expanded with SITOP UPS501S	Power 2.5 KW	24 V DC (22 ... 29 V)	24 V DC (23.3 ... 24.7 V DC or 24 V ± 3 %)
		Power 5 KW		
	SITOP DC UPS expansion module UPS501S, 7 A	Power 5 KW	24 V DC	24 V DC
	SITOP DC UPS basic device UPS500P, 7 A, IP65, cannot be expanded	Power 5 KW	24 V DC (22.5 ... 29 V DC)	24 V DC (23.3 ... 24.7 V DC or 24 V ± 3 %)
	Power 10 KW			

SITOP DC UPS with battery modules

SITOP UPS1600 DC UPS, can be combined with SITOP UPS1100 battery modules

	SITOP UPS1600 24 V/10 A	Without communications interface	24 V DC (21 ... 29 V)	Normal mode: U _e – approx. 0.01 × I Buffer mode: 27 V DC (no load); 24 V (50% battery rated current); 22 V (100% battery rated current); 18.5 V (exhaustive discharge protection)
		USB interface		
		2 Ethernet/PROFINET interfaces		
	SITOP UPS1600 24 V/20 A	Without communications interface	24 V DC (21 ... 29 V)	
		USB interface		
		2 Ethernet/PROFINET interfaces		
	SITOP UPS1600 24 V/40 A	Without communications interface	24 V DC (21 ... 29 V)	
		USB interface		
		2 Ethernet/PROFINET interfaces		

SITOP UPS1100 battery modules for SITOP UPS1600 DC UPS modules

	SITOP UPS1100 battery module for SITOP UPS1600, 10 A	24 V DC, 1.2 Ah	--	24 V DC, 22 ... 27.0 V DC (no load)
		24 V DC, 2.5 Ah, high temperature		
	SITOP UPS1100 battery module for SITOP UPS1600, 10 A and 20 A	24 V DC, 3.2 Ah	--	24 V DC, 22 ... 27.0 V DC (no load)
		24 V DC, 7 Ah		
		24 V DC, 5 Ah LiFePo		
	SITOP UPS1100 battery module for SITOP UPS1600, 20 A and 40 A	24 V DC, 12 Ah	--	24 V DC, 22 ... 27.0 V DC (no load)

SITOP Selection Tool

The SITOP Selection Tool offers detailed selection guidance according to criteria such as the required backup time, nominal current, peak current and battery connection threshold:
<http://www.siemens.com/tst>

SIMATIC PCS 7 system hardware

Process I/O

Power supplies

SITOP DC UPS uninterruptible power supplies

Ordering data	Article No.	Article No.
Uninterruptible 24 V DC power supplies		SITOP UPS1100 battery module for DC UPS module SITOP UPS1600
DC UPS with capacitors		Battery module SITOP UPS1100 24 V/1.2 Ah With maintenance-free, sealed rechargeable lead batteries for DC UPS module SITOP UPS1600, 10 A
DC UPS basic device SITOP UPS500S, 15 A Degree of protection IP20, input: 24 V DC; Output: 24 V DC; USB port; can be expanded with SITOP UPS501S • Power 2.5 KW • Power 5 KW	6EP1933-2EC41 6EP1933-2EC51	Battery module SITOP UPS1100 24 V/3.2 Ah With maintenance-free, sealed rechargeable lead batteries for DC UPS module SITOP UPS1600, 10 A and 20 A
DC UPS expansion module SITOP UPS501S, 7 A For connection to the basic device; Input: 24 V DC; Output: 24 V DC; power 5 KW	6EP1935-5PG01	Battery module SITOP UPS1100 24 V/7 Ah With maintenance-free, sealed rechargeable lead batteries for DC UPS module SITOP UPS1600, 10 A and 20 A
DC UPS basic device SITOP UPS500P, 7 A Degree of protection IP65, input: 24 V DC; Output: 24 V DC; USB port; cannot be expanded • Power 5 KW • Power 10 KW	6EP1933-2NC01 6EP1933-2NC11	Battery module SITOP UPS1100 24 V/5 Ah With maintenance-free, sealed lithium-ion rechargeable batteries for DC UPS module SITOP UPS1600, 10 A and 20 A
SITOP UPS1600 DC UPS can be combined with SITOP UPS1100 battery module		Battery module SITOP UPS1100 24 V/12 Ah With maintenance-free, sealed rechargeable lead batteries for DC UPS module SITOP UPS1600, 20 A and 40 A
DC UPS module SITOP UPS1600, 24 V/10 A Input: 24 V DC; Output: 24 V DC • Without communications interface • With USB interface • With 2 Ethernet/PROFINET interfaces	6EP4134-3AB00-0AY0 6EP4134-3AB00-1AY0 6EP4134-3AB00-2AY0	SITOP UPS 1100 battery module 2.5 Ah, high temperature With maintenance-free, sealed rechargeable pure-lead batteries for DC UPS module SITOP UPS1600, 10 A
DC UPS module SITOP UPS1600, 24 V/20 A Input: 24 V DC; Output: 24 V DC • Without communications interface • With USB interface • With 2 Ethernet/PROFINET interfaces	6EP4136-3AB00-0AY0 6EP4136-3AB00-1AY0 6EP4136-3AB00-2AY0	
DC UPS module SITOP UPS1600, 24 V/40 A Input: 24 V DC; Output: 24 V DC • Without communications interface • With USB interface • With 2 Ethernet/PROFINET interfaces	6EP4137-3AB00-0AY0 6EP4137-3AB00-1AY0 6EP4137-3AB00-2AY0	

Overview

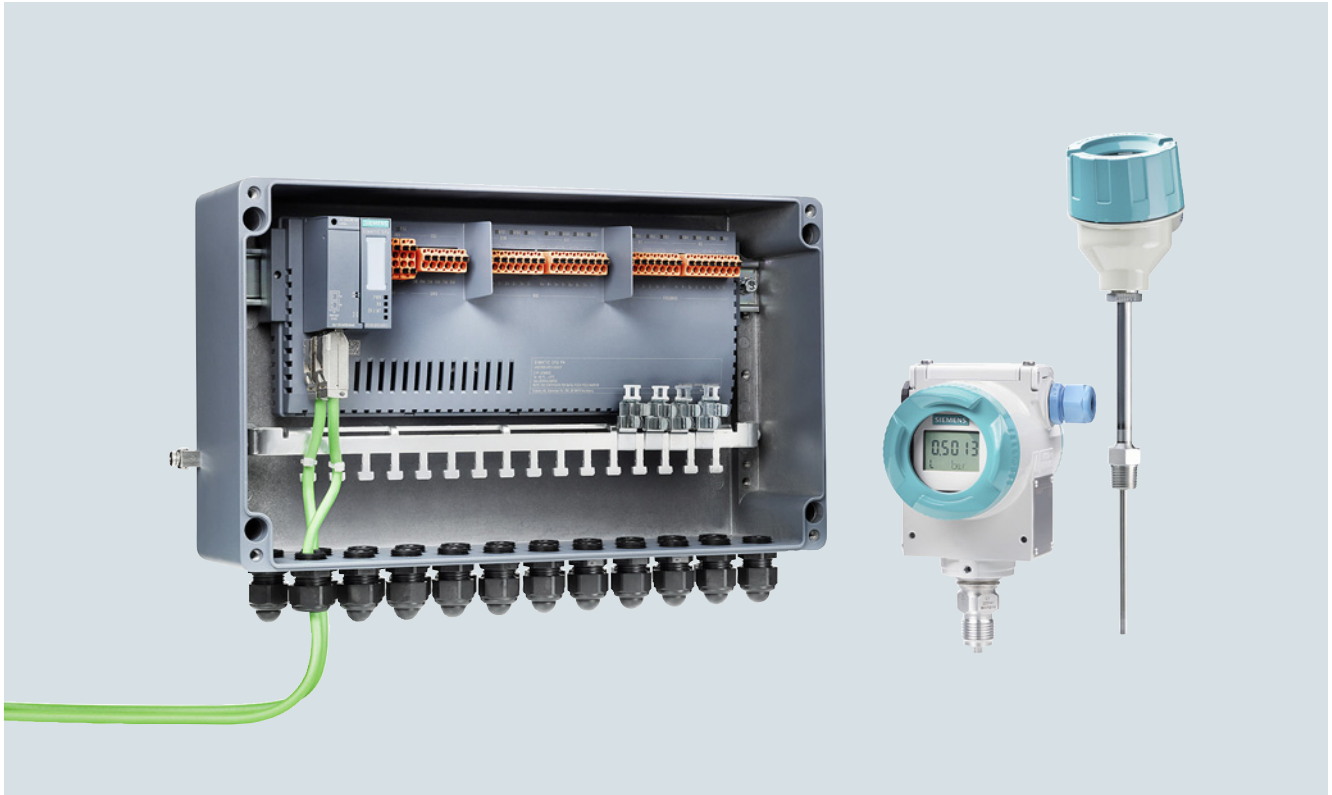
**Smart Field Distributor – SIMATIC Compact Field Unit**

Digitalization is an important catalyst for the process industry. When developing SIMATIC PCS 7 V9.0 – the new version of the proven SIMATIC PCS 7 process control system – the emphasis was placed on a forward-looking approach encompassing potential digitalization down to the field level. The system solution was therefore expanded with special high-performance and compact hardware products that support PROFINET – the world's leading Industrial Ethernet standard – and create more freedom for plant layout and operation. With the new SIMATIC Compact Field Unit (CFU), we are re-interpreting the conventional approach to field device connection. You benefit from more flexibility and easier handling, coupled with maximum availability. This allows you to efficiently transfer your familiar system concept to the digital world.

Today's challenges for field device connection:

- High overhead for device integration and replacement
- Complicated, error-prone wiring and routing over multiple levels, making the hardware FAT very complex
- Extremely long copper cables and numerous terminal points in the field
- Multiple individual control cabinets
- Large numbers of different components and protocols necessitate costly spare parts inventories and training sessions
- High planning and documentation costs

SIMATIC PCS 7 system hardware

Process I/O

SIMATIC CFU

Overview (continued)

SIMATIC CFU – The answer to these challenges

Mode of operation

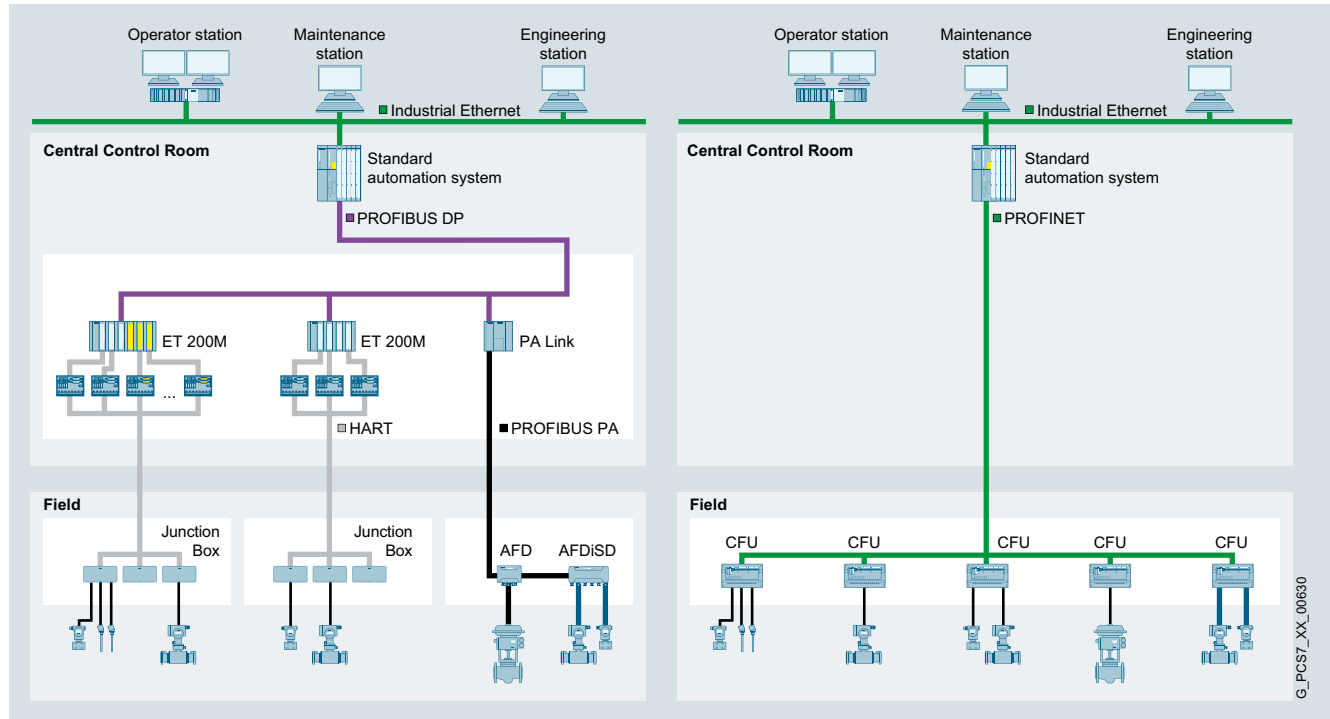

Field device connection with previous technology (left) and with SIMATIC CFU (right)

The new SIMATIC Compact Field Unit (CFU) is a real game-changer in field device connection and offers you entirely new prospects regarding simplicity and flexibility. The compact field distributor is installed at the process level and is connected via PROFINET directly to the process control system to form the foundation for digitalization in the field. Utilization of digital fieldbus communication considerably simplifies device interfacing compared to conventional 4 ... 20 mA engineering.

Greater flexibility thanks to consistent decentralization

Distributed installation of the SIMATIC CFU means that classic control cabinets are no longer required and you can make considerable savings in cabling and the number of terminal points, as well as reducing planning and documentation overheads. The high granularity (16 I/O per SIMATIC CFU) enables flexible assignment to the higher-level controllers.

G_PCS7_XX_00630

Function

The SIMATIC CFU was specifically designed to meet the requirements of the process industry in the Industry 4.0 environment (application example: SIMATIC CFU in a standard cast aluminum housing).

System integration via Industrial Ethernet standard

- Flexible connection options via PROFINET
- Ready for Process Automation (PA Ready):
 - Redundant PROFINET connection (S2) for maximum availability
 - Media redundancy (MRP)
 - Configuration in RUN (CiR)
- Bus Adapter (electrical, optical or combination)

Ready for distributed use

- Installation up to hazardous zone 2/22 (with conformal housing)
- Extended temperature range from -40 to +70 °C
- Conformal coating deployment at elevations up to 4 000 m
- Implementation of increased interference immunity according to NAMUR NE 21
- Optional: Aluminum enclosure for direct field deployment in zone 2/22

More information**Configuring with SIMATIC PCS 7 and third-party systems**

See information in Siemens Industry Online Support
<https://support.industry.siemens.com/cs/ww/en/view/109749357>

SIMATIC PCS 7 system hardware

Process I/O
SIMATIC CFU

SIMATIC CFU PA Edition

Overview

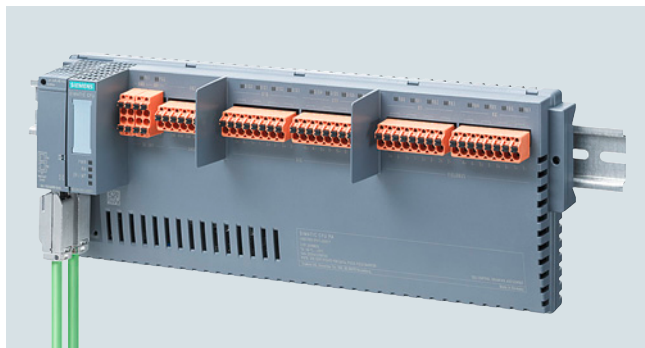

SIMATIC CFU here with BusAdapter, PROFINET bus cable and push-in terminals

SIMATIC CFU PA Edition

Plug-and-produce simplicity

Digitalization requires a digital infrastructure facilitating integrated digital communication right down to the sensors and actuators. You can use the established and proven PROFIBUS PA standard to achieve this. It is integrated into the PA Edition of the SIMATIC CFU, thus combining ruggedness and easy handling with all the advantages of the PROFINET standard based on Industrial Ethernet. Connected devices are automatically addressed. The device is integrated via standardized communication profiles.

This innovative new implementation of the PROFIBUS PA concept makes it possible to combine the simplicity of a point-to-point wiring system with the scalability of digital PROFIBUS PA fieldbus communication. As with digital field devices, it is not necessary to know prior to connection whether the discrete field device is a sensor or actuator – This can be easily configured afterwards via software.

Combination of digital fieldbus and discrete I/Os

- 8 × digital fieldbus (PROFIBUS PA)
- 8 × digital inputs/outputs, freely configurable (1 × counter functionality / frequency measurement)

Easy to use

- Automatic addressing of PROFIBUS PA field devices
- System-supported detection and integration of PROFIBUS PA field devices into the process control system
 - Utilization of standardized PA profiles
 - Commissioning, device replacement and maintenance wizards
- Implementation of diagnostic messages according to NAMUR NE 107
- Installation on a 35 mm DIN rail

Aluminum field housing

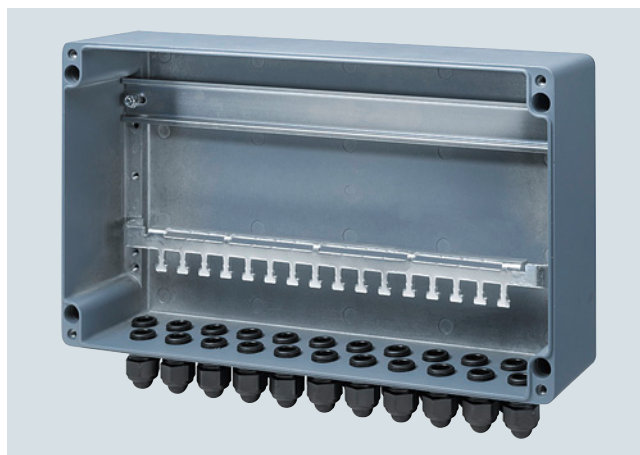

SIMATIC CFU aluminum field housing, open



SIMATIC CFU aluminum field housing, closed

The die-cast aluminum housing is suitable for use in zone 2/22 hazardous areas. The following are included in the housing scope of delivery:

- 22 × M20 plastic cable glands (incl. blanking plugs)
- 35 mm DIN rail
- Rail for strain relief and shield support

The housing has a display window for LED diagnostics.

Ordering data

Article No.

SIMATIC CFU PA bundle with push-in terminals

Comprising:

- SIMATIC CFU PA, Article No. 6ES7655-5PX11-0XX0
- SIMATIC CFU push-in terminals, Article No. 6ES7655-5PX00-1XX0

pre-assembled and tested

6ES7655-5PX11-1XX0

Article No.

SIMATIC CFU PA bundle with aluminum enclosure

Comprising:

- SIMATIC CFU PA, Article No. 6ES7655-5PX11-0XX0
- SIMATIC CFU push-in terminals, Article No. 6ES7655-5PX00-1XX0
- Aluminum enclosure with cable glands, shield busbar, shield connection clamps

pre-assembled and tested

6ES7655-5PX11-1AX0

Technical specifications

Article number	6ES7655-5PX11-1XX0 SIMATIC CFU PA BUNDLE	6ES7655-5PX11-1AX0 SIMATIC CFU PA Bundle with Alu housing
General information		
Product type designation	Compact Field Unit	
Number of channels	16	
Product function		
• I&M data	Yes; I&M0 to I&M4	
• Isochronous mode	No	
• The user can configure digital channels as input/output as required	Yes	
• Digital channels can be parameterized	Yes	
Engineering with		
• STEP 7 configurable/integrated from version	V5.6 HF2 and higher	
• PCS 7 configurable/integrated from version	V9.0 SP2 and higher	
• PROFINET from GSD version/ GSD revision	GSDML V2.3	
Operating mode		
• Counter	Yes	
Installation type/mounting		
Mounting	on 35 mm DIN rail, 2 spacing units wide	
Mounting position	Horizontal, vertical	Horizontal, vertical
Recommended mounting position	horizontal set up	
Supply voltage		
Type of supply voltage	24 V DC	
Rated value (DC)	24 V	
Reverse polarity protection	Yes	
Short-circuit protection	Yes	
Redundant power supply	Yes	
Mains buffering		
• Mains/voltage failure stored energy time	5 ms; Bridging for field devices and communication	
Input current		
Current consumption (rated value)	2.5 A	
Current consumption, max.	2.55 A	
Inrush current, max.	8 A	
I^2t	0.3 A ² ·s	
Encoder supply		
Number of outputs	8	
Output voltage, min.	18.2 V	
Short-circuit protection	Yes; Electronic	
Output current		
• up to 60 °C, max.	2 A	
• up to 70 °C, max.	1 A	
Power loss		
Power loss, typ.	8.2 W; Depending on the type of BusAdapter used (typ. RJ45)	
Address area		
Address space per station		
• Address space per station, max.	1 440 byte; Dependent on configuration	

SIMATIC PCS 7 system hardware

Process I/O
SIMATIC CFU

SIMATIC CFU PA Edition

Technical specifications (continued)

Article number	6ES7655-5PX11-1XX0 SIMATIC CFU PA BUNDLE	6ES7655-5PX11-1AX0 SIMATIC CFU PA Bundle with Alu housing
Digital inputs		
Number of digital inputs	8	
Source/sink input	Yes; P-reading	
Input characteristic curve in accordance with IEC 61131, type 1	Yes	
Input characteristic curve in accordance with IEC 61131, type 2	No	
Input characteristic curve in accordance with IEC 61131, type 3	Yes	
Pulse extension	No	
Number of simultaneously controllable inputs		
horizontal installation		
- up to 60 °C, max.	8; Total current must be observed, see DQ	
- up to 70 °C, max.	8; Total current must be observed, see DQ	
vertical installation		
- up to 60 °C, max.	8; Total current must be observed, see DQ	
Digital input functions, parameterizable		
• Counter	Yes	
- Number, max.	1	
- Counting frequency, max.	1 kHz	
- Counting width	32 bit	
- Counting direction up/down	Yes; Up	
Input voltage		
• Rated value (DC)	24 V	
• for signal *0*	-30 to +5 V	
• for signal *1*	+11 to +30V	
Input current		
• for signal *1*, typ.	2.5 mA; Typical	
Input delay (for rated value of input voltage) for standard inputs		
- parameterizable	No	
- at *0* to *1*, max.	3.2 ms; for counter function 0,1 ms	
- at *1* to *0*, max.	3.2 ms; for counter function 0,1 ms	
Cable length		
• shielded, max.	1 000 m	
• unshielded, max.	600 m	
Digital outputs		
Type of digital output	Transistor	
Number of digital outputs	8	
Current-sinking	No	
Current-sourcing	Yes	
Short-circuit protection	Yes	
• Response threshold, typ.	0.7 to 1.3 A	
Limitation of inductive shutdown voltage to	Typ. L+ (-50 V)	
Controlling a digital input	Yes	
Switching capacity of the outputs		
• on lamp load, max.	5 W	
Load resistance range		
• lower limit	48 Ω	
• upper limit	12 kΩ	
Output voltage		
• Type of output voltage	DC	
• for signal *1*, min.	U _e minus 1 V	
Output current		
• for signal *1* rated value	0.5 A	
• for signal *0* residual current, max.	0.1 mA	

Technical specifications (continued)

Article number	6ES7655-5PX11-1XX0	6ES7655-5PX11-1AX0
	SIMATIC CFU PA BUNDLE	SIMATIC CFU PA Bundle with Alu housing
Output delay with resistive load		
• "0" to "1", max.	50 µs	
• "1" to "0", max.	100 µs	
Parallel switching of two outputs		
• for uprating	No	
• for redundant control of a load	No	
Switching frequency		
• with resistive load, max.	100 Hz	
• with inductive load, max.	2 Hz	
• on lamp load, max.	10 Hz	
Total current of the outputs		
• Current per channel, max.	0.5 A	
horizontal installation		
- up to 60 °C, max.	2 A	
- up to 70 °C, max.	1 A	
vertical installation		
- up to 60 °C, max.	2 A	
Cable length		
• shielded, max.	1 000 m	
• unshielded, max.	600 m	
Encoder		
Connectable encoders		
• 2-wire sensor	Yes	
- permissible quiescent current (2-wire sensor), max.	1.5 mA	
Interfaces		
Number of PROFINET interfaces	1	
Number of PROFIBUS interfaces	0	
PROFIBUS PA		
• Transmission rate, max.	31.25 kbit/s	
• Number of connectable PA field devices	8; electrically isolated from other interfaces, isolation tested at 2 500 V DC	
• Current output to PA field devices, max.	320 mA	
• permissible current per spur line	40 mA	
• Automatic addressing	Yes	
• System-supported integration of field devices via PA profiles	Yes	
• Extended fieldbus diagnostics	Yes	
1. Interface		
Isolated	Yes	
Interface types		
• Number of ports	2	
• integrated switch	Yes	
• BusAdapter (PROFINET)	Yes	
Protocols		
• PROFINET IO Device	Yes	
• PROFIBUS DP slave	No	
Interface types		
RJ 45 (Ethernet)		
• 100 Mbps	Yes	
• Autonegotiation	Yes	
• Autocrossing	Yes	

SIMATIC PCS 7 system hardware

Process I/O

SIMATIC CFU

SIMATIC CFU PA Edition**Technical specifications** (continued)

Article number	6ES7655-5PX11-1XX0 SIMATIC CFU PA BUNDLE	6ES7655-5PX11-1AX0 SIMATIC CFU PA Bundle with Alu housing
Protocols		
Supports protocol for PROFINET IO	Yes	
Redundancy mode		
• PROFINET system redundancy (S2)	Yes; Type S2	
Media redundancy		
- MRP	Yes	
Open IE communication		
• LLDP	Yes	
Interrupts/diagnostics/ status information		
Status indicator	Yes	
Alarms	Yes	
Diagnostics function	Yes	
Diagnoses		
• Monitoring of encoder power supply	Yes	
• Wire-break	Yes	
• Short-circuit	Yes	
Diagnostics indication LED		
• RUN LED	Yes; green LED	
• ERROR LED	Yes; red LED	
• MAINT LED	Yes; Yellow LED	
• Monitoring of the supply voltage (PWR-LED)	Yes	
• Status indicator digital input (green)	Yes	
• Status indicator digital output (green)	Yes	
• Spur line status/fault	Yes	
Potential separation		
between the channels and PROFINET	Yes	
Potential separation digital inputs		
• between the channels	No	
• between the channels and the power supply of the electronics	No	
Potential separation digital outputs		
• between the channels	No	
• between the channels and the power supply of the electronics	No	
Degree and class of protection		
IP degree of protection	IP20	IP66
Ambient conditions		
Ambient temperature during operation		
• min.	-40 °C	
• max.	70 °C	

Technical specifications (continued)

Article number	6ES7655-5PX11-1XX0 SIMATIC CFU PA BUNDLE	6ES7655-5PX11-1AX0 SIMATIC CFU PA Bundle with Alu housing
Connection method		
Design of electrical connection	Connection plug	
Spur line		
• Number of spur lines	8	
• Type of cable	Type A	
• Cable diameter, min.	6 mm	
• Cable diameter, max.	12 mm	
• Conductor cross-section, min.	0.2 mm ²	
• Conductor cross-section, max.	2.5 mm ²	
• Cable length, max.	120 m	
• total current output to field devices, max.	320 mA	
• Number of connectable field devices	8	
• Current limitation per field device, max.	40 mA	
• No-load voltage, max.	15.3 V	
• short-circuit proof	Yes	
• Short-circuit current (test current); max.	8 mA	
• intrinsically safe according to FISCO model	Yes	
• Debounce logic	Yes	
Dimensions		
Width	329 mm	414 mm
Height	123 mm	266 mm
Depth	74 mm	111 mm
Weights		
Weight, approx.	650 g	5.5 kg

SIMATIC PCS 7 system hardware

Process I/O

SIMATIC CFU

SIMATIC CFU DIQ Edition

Overview

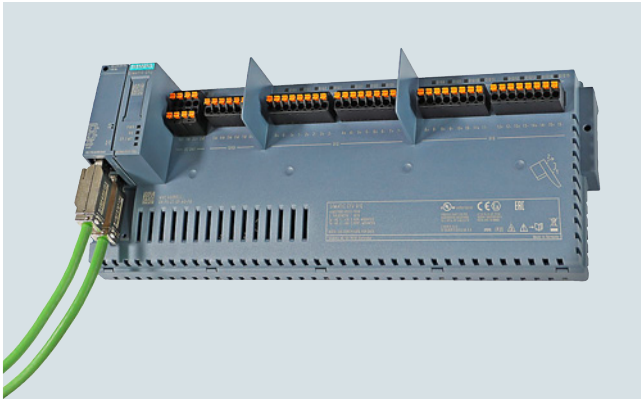

SIMATIC CFU DIQ Edition

Individual, customer-specific solutions and flexible system/plant extensions are requirements that are becoming increasingly important in the process industry due to digitalization. SIMATIC CFU DIQ Edition with 16 freely configurable digital IO channels offers a solution for the growing demands of distributed I/O.

SIMATIC CFU also has expansion functions for optional configuration. Two additional operating modes can be activated for selected digital inputs. "Counter" operating mode and "Frequency measurement" operating mode with a cut-off frequency of 1 kHz.

Actuator disconnection can be set for the digital outputs. The actuator disconnection of the SIMATIC CFU uses a monitoring channel (DI channel) to quickly set all digital outputs to a low digital level.

- 16 × digital inputs/outputs, freely configurable (2 x counter functionality / frequency measurement)

Aluminum field housing

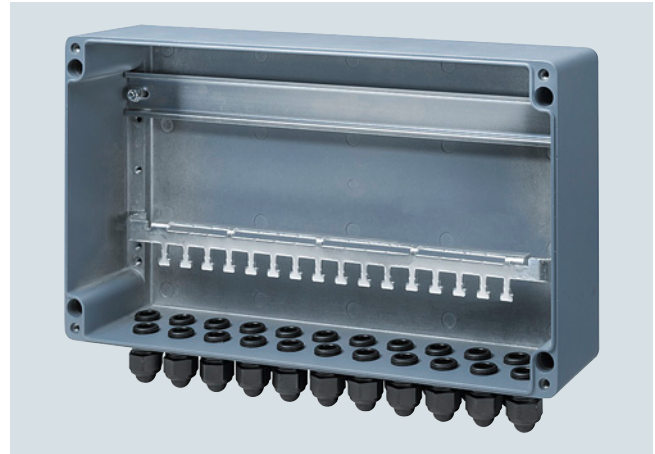

SIMATIC CFU aluminum field housing, open



SIMATIC CFU aluminum field housing, closed

The die-cast aluminum housing is suitable for use in zone 2/22 hazardous areas. The following are included in the housing scope of delivery:

- 22 × M20 plastic cable glands (incl. blanking plugs)
- 35 mm DIN rail
- Rail for strain relief and shield support

The housing has a display window for LED diagnostics.

Ordering data

Article No.

SIMATIC CFU DIQ with aluminum housing

Comprising:

- SIMATIC CFU DIQ, Article No. 6ES7655-5PX31-0XX0
- SIMATIC CFU push-in terminals, Article No. 6ES7655-5PX00-1XX0
- Aluminum housing with cable glands, shield busbar, shield connection clamp

pre-assembled and tested

6ES7655-5PX31-1AX0

Article No.

SIMATIC CFU DIQ

Comprising:

- SIMATIC CFU DIQ, Article No. 6ES7655-5PX31-0XX0
- SIMATIC CFU push-in terminals, Article No. 6ES7655-5PX31-1XX0

pre-assembled and tested

6ES7655-5PX31-1XX0

Technical specifications

Article number	6ES7655-5PX31-1AX0 SIMATIC CFU DIQ with Alu housing	6ES7655-5PX31-1XX0 SIMATIC CFU DIQ
General information		
Product type designation		Compact Field Unit
Number of channels		16
Product function		
<ul style="list-style-type: none"> I&M data Isochronous mode The user can configure digital channels as input/output as required Digital channels can be parameterized 		Yes; I&M0 to I&M4 No Yes Yes
Engineering with		
<ul style="list-style-type: none"> STEP 7 configurable/integrated from version PCS 7 configurable/integrated from version PROFINET from GSD version/ GSD revision 		V5.6 HF2 and higher V9.0 SP2 and higher GSDML V2.3
Operating mode		
<ul style="list-style-type: none"> Counter 		Yes
Installation type/mounting		
Mounting		on 35 mm DIN rail, 2 spacing units wide
Mounting position	Horizontal, vertical	Horizontal, vertical
Recommended mounting position	horizontal set up	
Supply voltage		
Type of supply voltage		24 V DC
Rated value (DC)		24 V
Reverse polarity protection		Yes
Short-circuit protection		Yes
Redundant power supply		Yes
Mains buffering		
<ul style="list-style-type: none"> Mains/voltage failure stored energy time 		5 ms; For communication
Input current		
Current consumption (rated value)		5.12 A
Current consumption, max.		5.13 A
Inrush current, max.		4.8 A
I^2t		0.073 A ² ·s
Encoder supply		
Number of outputs		16
Output voltage, min.		18.2 V
Short-circuit protection		Yes; Electronic
Output current		
<ul style="list-style-type: none"> up to 60 °C, max. up to 70 °C, max. 		5 A 4 A
Power loss		
Power loss, typ.		2.88 W; Depending on the type of BusAdapter used (typ. RJ45)
Address area		
Address space per station		
<ul style="list-style-type: none"> Address space per station, max. 		1 440 byte; Dependent on configuration

SIMATIC PCS 7 system hardwareProcess I/O
SIMATIC CFU**SIMATIC CFU DIQ Edition****Technical specifications** (continued)

Article number	6ES7655-5PX31-1AX0 SIMATIC CFU DIQ with Alu housing	6ES7655-5PX31-1XX0 SIMATIC CFU DIQ
Digital inputs		
Number of digital inputs		16
Source/sink input		Yes; P-reading
Input characteristic curve in accordance with IEC 61131, type 1		Yes
Input characteristic curve in accordance with IEC 61131, type 2		No
Input characteristic curve in accordance with IEC 61131, type 3		Yes
Pulse extension		No
Number of simultaneously controllable inputs		
horizontal installation		
- up to 60 °C, max.		16; Total current must be observed, see DQ
- up to 70 °C, max.		16; Total current must be observed, see DQ
vertical installation		
- up to 60 °C, max.		16; Total current must be observed, see DQ
Digital input functions, parameterizable		
• Counter		Yes
- Number, max.		2
- Counting frequency, max.		1 kHz
- Counting width		32 bit
- Counting direction up/down		Yes; Up
Input voltage		
• Rated value (DC)		24 V
• for signal *0*		-30 to +5 V
• for signal *1*		+11 to +30V
Input current		
• for signal *1*, typ.		2.5 mA; Typical
Input delay (for rated value of input voltage)		
for standard inputs		
- parameterizable		No
- at *0* to *1*, max.		3.2 ms; for counter function 0,1 ms
- at *1* to *0*, max.		3.2 ms; for counter function 0,1 ms
Cable length		
• shielded, max.		1 000 m
• unshielded, max.		600 m
Digital outputs		
Type of digital output		Transistor
Number of digital outputs		16
Current-sinking		No
Current-sourcing		Yes
Short-circuit protection		Yes
• Response threshold, typ.		0.7 to 1.3 A
Limitation of inductive shutdown voltage to		Typ. L+ (-50 V)
Controlling a digital input		Yes
Switching capacity of the outputs		
• on lamp load, max.		5 W
Load resistance range		
• lower limit		48 Ω
• upper limit		12 kΩ
Output voltage		
• Type of output voltage		DC
• for signal *1*, min.		Ue minus 1 V
Output current		
• for signal *1* rated value		0.5 A
• for signal *0* residual current, max.		0.1 mA

Technical specifications (continued)

Article number	6ES7655-5PX31-1AX0 SIMATIC CFU DIQ with Alu housing	6ES7655-5PX31-1XX0 SIMATIC CFU DIQ
Output delay with resistive load		
• "0" to "1", max.		50 µs
• "1" to "0", max.		100 µs
Parallel switching of two outputs		
• for uprating		No
• for redundant control of a load		No
Switching frequency		
• with resistive load, max.		100 Hz
• with inductive load, max.		2 Hz
• on lamp load, max.		10 Hz
Total current of the outputs		
• Current per channel, max.		0.5 A
horizontal installation		
- up to 60 °C, max.		5 A
- up to 70 °C, max.		4 A
vertical installation		
- up to 60 °C, max.		5 A
Cable length		
• shielded, max.		1 000 m
• unshielded, max.		600 m
Encoder		
Connectable encoders		
• 2-wire sensor		Yes
- permissible quiescent current (2-wire sensor), max.		1.5 mA
Interfaces		
Number of PROFINET interfaces		1
Number of PROFIBUS interfaces		0
1. Interface		
Isolated		Yes
Interface types		
• Number of ports		2
• integrated switch		Yes
• BusAdapter (PROFINET)		Yes
Protocols		
• PROFINET IO Device		Yes
• PROFIBUS DP slave		No
Interface types		
RJ 45 (Ethernet)		
• 100 Mbps		Yes
• Autonegotiation		Yes
• Autocrossing		Yes
Protocols		
Supports protocol for PROFINET IO		Yes
Redundancy mode		
• PROFINET system redundancy (S2)		Yes; Type S2
Media redundancy		
- MRP		Yes
Open IE communication		
• LLDP		Yes

SIMATIC PCS 7 system hardware

Process I/O

SIMATIC CFU

SIMATIC CFU DIQ Edition**Technical specifications** (continued)

Article number	6ES7655-5PX31-1AX0 SIMATIC CFU DIQ with Alu housing	6ES7655-5PX31-1XX0 SIMATIC CFU DIQ
Interrupts/diagnostics/ status information		
Status indicator		Yes
Alarms		Yes
Diagnostics function		Yes
Diagnoses		
• Monitoring of encoder power supply		Yes
• Wire-break		Yes
• Short-circuit		Yes
Diagnostics indication LED		
• RUN LED		Yes; green LED
• ERROR LED		Yes; red LED
• MAINT LED		Yes; Yellow LED
• Monitoring of the supply voltage (PWR-LED)		Yes
• Status indicator digital input (green)		Yes
• Status indicator digital output (green)		Yes
Potential separation		
between the channels and PROFINET		Yes
Potential separation digital inputs		
• between the channels		No
• between the channels and the power supply of the electronics		No
Potential separation digital outputs		
• between the channels		No
• between the channels and the power supply of the electronics		No
Degree and class of protection		
IP degree of protection	IP66	IP20
Ambient conditions		
Ambient temperature during operation		
• min.		-40 °C
• max.		70 °C
Connection method		
Design of electrical connection		Connection plug
Dimensions		
Width	414 mm	329 mm
Height	266 mm	123 mm
Depth	111 mm	74 mm
Weights		
Weight, approx.	5.5 kg	610 g

Overview



BusAdapter BA 2xRJ45, 2xFC and 2xLC

BusAdapter

A BusAdapter as a separate component allows a free choice of SIMATIC CFU connection to PROFINET:

- BA 2xRJ45:
2 electrical connections for bus cables with standard RJ45 connectors
- BA 2xFC:
2 electrical connections for direct connection of FastConnect bus cable
- BA 2xLC:
2 optical ports for fiber-optic cables
- BA 1xLC, 1xRJ45:
Combination bus adapter comprising 1 optical connection and one electrical connection standard RJ45
- BA 1xLC, 1xFC:
Combination bus adapter 1 optical connection and 1 electrical connection for direct connection of FastConnect bus cable
- BA 2xRJ45 VD:
2 electrical connections for Ethernet communication via 2, 4 or 8-wire copper cables and distances up to 500 m

Ordering data

Article No.

BusAdapter	Article No.
BusAdapter BA 2xRJ45 2 × RJ45 connections for PROFINET (standard Ethernet socket)	6DL1193-6AR00-0AA0
BusAdapter BA 2xFC 2 × FastConnect (FC) connections for PROFINET	6DL1193-6AF00-0AA0
BusAdapter BA 2xLC 2 × glass fiber-optic connections	6DL1193-6AG00-0AA0
BusAdapter BA LC/RJ45 2 × glass fiber-optic connections	6DL1193-6AG20-0AA0
BusAdapter BA LC/FC 2 × glass fiber-optic connections	6DL1193-6AG40-0AA0
BusAdapter BA 2xRJ45 (VD) 2 × electrical connections for Ethernet communication via 2, 4 or 8-wire copper cables and distances up to 500 m	6GK5991-2VA00-8AA2

Technical specifications

Article number	6DL1193-6AR00-0AA0 ET 200SP HA, BUSADAPTER BA 2XRJ45	6DL1193-6AF00-0AA0 ET 200SP HA, BUSADAPTER BA 2XFC	6DL1193-6AG00-0AA0 ET 200SP HA, BUSADAPTER BA 2XLC
General information			
Product type designation	BA 2x RJ45	BA 2xFC	BA 2xLC
Interfaces			
Number of PROFINET interfaces	1; 2 ports (switch) RJ45	1; 2 ports (switch) FC	1; 2 ports (switch) LC Multimode Glass Fibre
Supports protocol for PROFINET IO			
• Number of RJ45 ports	2		
• Number of FC (FastConnect) connections		2	
• Number of LC ports			2
Cable length			
- Cu conductors	100 m	100 m	
- Multimode graded-index fiber 50/125 µm			3 km
- Multimode graded-index fiber 62.5/125 µm			3 km

SIMATIC PCS 7 system hardware

Process I/O
SIMATIC CFU

BusAdapter

Technical specifications (continued)

Article number	6DL1193-6AR00-0AA0 ET 200SP HA, BUSADAPTER BA 2XRJ45	6DL1193-6AF00-0AA0 ET 200SP HA, BUSADAPTER BA 2XFC	6DL1193-6AG00-0AA0 ET 200SP HA, BUSADAPTER BA 2XLC
Ambient conditions			
Ambient temperature during operation			
• min.	-40 °C	-40 °C	-40 °C
• max.	70 °C	70 °C	65 °C; redundant design (2x 6DL1155-6AU00-0PM0): max. 60 °C horizontal, max. 50 °C vertical. When using different I/O devices, the derating specified there must be observed
Dimensions			
Width	20 mm	20 mm	20 mm
Height	69.5 mm	69.5 mm	75 mm; Without protective caps (approx. 8 mm)
Depth	59 mm	59 mm	59 mm
Weights			
Weight, approx.	46 g	53 g	60 g
Article number	6DL1193-6AG20-0AA0 ET 200SP HA, BUSADAPTER BA LC/RJ45	6DL1193-6AG40-0AA0 ET 200SP HA, BUSADAPTER BA LC/FC	
General information			
Product type designation	BA LC/RJ45	BA LC/FC	
Interfaces			
Number of PROFINET interfaces	1; 2 ports (switch) LC / RJ45	1; 2 ports (switch) LC / FC	
Supports protocol for PROFINET IO			
• Number of RJ45 ports	1	1	
• Number of FC (FastConnect) connections			
• Number of LC ports	1; Wavelength of 1 270 ... 1 380 nm, corresponds to 100BASE-FX	1; Wavelength of 1 270 ... 1 380 nm, corresponds to 100BASE-FX	
Cable length			
- Cu conductors	100 m	100 m	
- Multimode graded-index fiber 50/125 µm	3 km	3 km	
- Multimode graded-index fiber 62.5/125 µm	3 km	3 km	
Standards, approvals, certificates			
RoHS conformity	Yes	Yes	
China RoHS compliance	Yes	Yes	
Ambient conditions			
Ambient temperature during operation			
• min.	-40 °C	-40 °C	
• max.	70 °C; = Tmax for horizontal installation; for vertical installation Tmax = 60 °C; redundant setup (2x 6DL1155-6AU00-0PM0): max. 65 °C horizontally, max. 60 °C vertically. When using different IO Devices, the derating specified there must be observed.	65 °C; = Tmax for horizontal installation; for vertical installation Tmax = 60 °C; redundant setup (2x 6DL1155-6AU00-0PM0): max. 60 °C horizontally, max. 55 °C vertically. When using different IO Devices, the derating specified there must be observed.	
Dimensions			
Width	20 mm	20 mm	
Height	75 mm; Without protective caps (approx. 8 mm)	75 mm; Without protective caps (approx. 8 mm)	
Depth	59 mm	59 mm	
Weights			
Weight, approx.	32 g	50 g	

Ordering data	Article No.
Connection system	
SIMATIC CFU screw-type terminals Complete set of screw-type terminals for SIMATIC CFU: two-tier 2x2 (24 V), single-tier 1x6 (GND) and single-tier 4x8 (IO)	6ES7655-5PX00-2XX0
SIMATIC CFU push-in terminals Complete set of push-in terminals for SIMATIC CFU: two-tier 2x2 (24 V), single-tier 1x6 (GND) and single-tier 4x8 (IO)	6ES7655-5PX00-1XX0

SIMATIC PCS 7 system hardware

Process I/O

SIMATIC ET 200SP HA

Overview

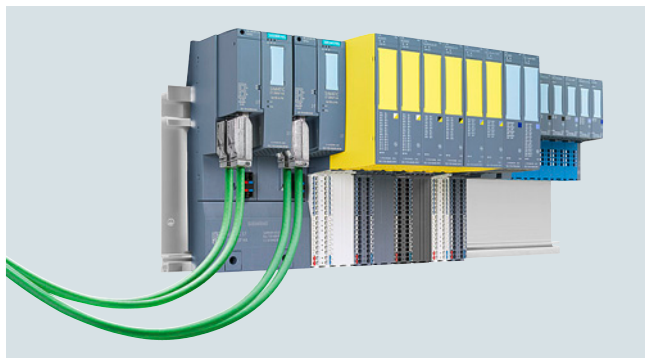

SIMATIC ET 200SP HA F IO Redundant Station 2PN

Compact design, flexible connection possibilities and high system availability with redundant PROFINET connections: the SIMATIC ET 200SP HA distributed I/O system is perfectly suited to the requirements of the process industry. The new design allows up to 56 I/O modules per station. An impressively high concentration of up to 32 channels on a module that is only 22.5 mm wide allows for maximum economy in the control cabinet.

Redundant PROFINET connections allow the connection of high-availability controllers via two independent networks, with a choice of copper or fiber-optic cables. The system can be scaled and extended in small steps using a variety of available modules, for example with digital and analog I/Os as well as NAMUR, HART, and other protocols. All 24 V standard signals are connected via an identical terminal block type, which allows a high degree of standardization for the control cabinets.

SIMATIC ET 200SP HA is designed for use in the control cabinet as well as for hazardous areas up to Ex zone 2. The extended temperature range from -40 to +70 °C and the conformal coating of all components allow direct installation in the field.

You also benefit in engineering from seamless integration in SIMATIC PCS 7. The SIMATIC ET 200SP HA in combination with the Advanced Process Library also offers flexible and simple online parameter assignment and selection of up to four HART variables per channel.

Benefits

Highlights at a glance

- Availability
 - Redundancy at the PROFINET interface (S2 or R1)
 - Terminal block with integrated I/O redundancy
 - Hot swapping during runtime
 - Station expansion possible during runtime
- Easy to use
 - Compact modules with permanent wiring
 - One terminal block for all 24 V standard signals
 - Tool-free connection system with push-in terminals
- Compact design
 - Compact with up to 56 I/O modules per station
 - High concentration of up to 32 channels on a module that is only 22.5 mm wide
 - System-integrated power bus
- Seamless integration in SIMATIC PCS 7
- PROFINET IO communication standard

Design

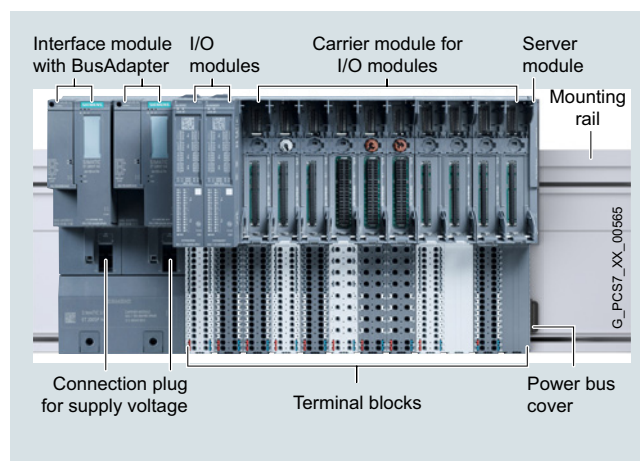

ET 200SP HA for SIMATIC PCS 7, design

Easy handling and high availability

The SIMATIC ET 200SP HA impresses with its particularly simple installation and assembly. The new terminal layout and push-in technology make tool-free wiring possible. Control cabinet configuration is particularly flexible, as the separation of mechanical and electronic components allows the station to be pre-wired without I/O modules. Empty modules can be inserted in the integrated terminal blocks and easily replaced at any time. Station extension during operation offers additional advantages for plant flexibility and availability.

In addition to the option of operating the SIMATIC ET 200SP HA station redundantly over the PROFINET interface, you can also operate the I/O modules redundantly. This option is implemented using a terminal block for integrated I/O redundancy, which is very cost-effective and saves a lot of space. The new design with standardized terminal blocks makes redundant wiring as simple as single operation.

Design (continued)**Main components of the SIMATIC ET 200SP HA distributed I/O system**

The SIMATIC ET 200SP HA distributed I/O system consists of the following components:

Mounting rail

The mounting rail is required for fitting an ET 200SP HA station in the control cabinet. The IM carrier modules for interface modules, the carrier modules for the I/O modules and the server module are attached to the mounting rail.

IM carrier module for interface modules

Two versions of the IM carrier modules are available:

- IM single carrier module for 1 interface module, for single connection to PROFINET
- IM redundant carrier module for 2 interface modules, for redundant connection to PROFINET

IM 155-6 PN interface module and BusAdapter

The interface module ensures communication between the ET 200SP HA station and the SIMATIC PCS 7 automation system (controller) over PROFINET. A BusAdapter as a separate component allows a free choice of connection technology:

- BA 2×RJ45: 2 electrical connections for bus cable with standard RJ45 connector
- BA 2×FC: 2 electrical connections for direct connection of FastConnect bus cable
- BA 2×LC: 2 optical ports for fiber-optic cables

Carrier module and terminal blocks for I/O modules

The slots for the I/O modules are created by connecting carrier modules and terminal blocks. The carrier modules provide the electrical and mechanical connections for the individual modules; the terminal blocks contain the process terminals for connecting sensors, actuators and other devices.

Two versions of the carrier modules are available, one with 2 slots and one with 8 slots for I/O modules.

The selection of available terminal blocks determines the following properties:

- Type of load voltage supply
- Formation of potential groups
- Type of required I/O module
- Redundant configuration of I/O modules

I/O modules

Modules with 8 or 16 digital channels (DI, DQ) and with 8 or 16 analog channels (AI, AQ) are available as I/O modules. A relay module (RQ) and a universal analog/digital module (AI-DI/DQ) can also be supplied.

All I/O modules with a signal voltage of up to 24 V DC can also be used redundantly.

Slot covers can be attached if I/O modules are not to be inserted in slots or slots are to be reserved for later expansion. You can insert a label strip for the planned I/O module on the front of the slot cover.

Server module and power bus cover

The server module and power bus cover complete the configuration of the ET 200SP HA station. The power bus cover protects the power bus contacts.

Function**Main functions**Compact I/O modules

- Up to 32 channels on a module that is 22.5 mm wide
- Up to 56 modules per station

Perfectly suited for applications in the field

- Installation up to hazardous zone 2
- Extended temperature range: -40 to +70 °C
- Enhanced interference immunity in accordance with NAMUR recommendation NE21
- Conformal coating on all components
- Can be used at altitudes of up to 4 000 meters

Wide range of supported module types

- 16×AI, 8×AO HART, 16×DI, 16×DO etc.

Standard I/O terminal block

- For all 24 V signals AI, AO, DI, DO

SIMATIC PCS 7 system hardware

Process I/O

SIMATIC ET 200SP HA

Function (continued)

Redundant configurations

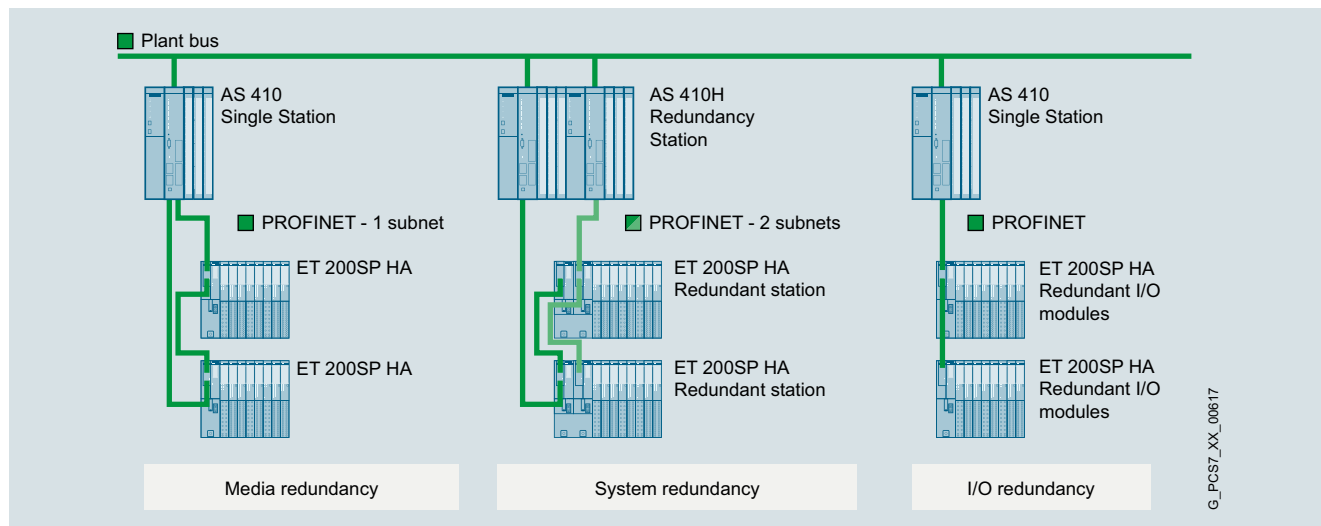

SIMATIC ET 200SP HA, basic redundant configurations

The availability of the ET 200SP HA distributed I/O can if necessary be increased with redundant configurations. A number of different configurations are possible (the individual redundant configurations can also be combined):

Media redundancy

ET 200SP HA stations with 1 interface module each are connected to an automation system in a ring topology. At least one device in the ring takes on the role of the redundancy manager; the other devices in the ring are redundancy clients. The automation system is configured as MRP manager.

If the ring topology is interrupted, the ET 200SP HA stations in the system remain available.

One of the following functions is possible in runtime:

- Connecting and removing ET 200SP HA stations
- Replacing PROFINET cables

System redundancy

ET 200SP HA stations are connected to a redundant automation system. All components used redundantly are in continuous operation. If a redundancy partner fails, the function is maintained by transferring the master role or selecting a different communication path.

The ET 200SP HA stations remain available in the PROFINET IO system if a CPU or a PROFINET cable fails.

One of the following functions is possible in runtime:

- Connecting and removing ET 200SP HA stations
- Replacing PROFINET cables
- Replacing a CPU

I/O redundancy

To configure I/O redundancy, 2 I/O modules of the same type are inserted beside each other in a terminal block for redundant configuration (width: 45 mm). This terminal block connects the process signals of the two modules to a common process terminal. The advantages are:

- There is less wiring work than for connecting separate I/O modules, as interconnection of the process signals is integrated in the system.
- Redundant signal processing of the sensors and actuators at a module level increases the availability of the system.

The following applies if an I/O module or a channel of one of the two I/O modules fails:

- Error-free inputs remain available in the system.
- Error-free outputs continue to be controlled in the system.

One of the following functions is possible for an I/O module in a module pair in error-free operation:

- Firmware update
- Replacing a module

Overview



IM 155-6 PN HA

IM 155-6 PN HA interface module

The IM 155-6 PN HA together with the IM carrier module and the BusAdapter forms the interface of the ET 200SP HA. The interface is used for communication between the CPU and the connected ET 200SP HA I/O modules over PROFINET.

Function

Properties of the ET 200SP HA interface

The ET 200SP HA interface has the following technical features:

- 1L+ 24 V DC supply voltage (SELV/PELV). The supply voltage is fed in via the IM carrier module. The connector is included in the scope of delivery of the interface module.
- PROFINET connection over BusAdapter

The interface supports the following functions:

- Firmware update
- I&M identification data
- Adding/removing modules in RUN
- Value status QI
- I/O redundancy
- Time stamping
- Multi hot swap (removing/plugging in multiple I/O modules during operation)
- Save service data
- Recording the value status of the I/O modules
- Reference temperature distribution

The interface can be configured with HW Config.

PROFINET functions

The ET 200SP HA interface supports the following PROFINET functions:

- Integrated BusAdapter with 2 ports
- Ethernet services supported: ping, arp, network diagnostics (SNMP)/MIB-2, LLDP-MIB and MRP-MIB
- Port diagnostics
- Disabling ports
- Minimum update time 250 μ s
- Device replacement without programming device
- Reset to factory settings using PROFINET IO
- System redundancy S2
- System redundancy R1
- Media redundancy (MRP)
- Support for submodules on suitable I/O modules

Ordering data

Article No.

Interface module

PROFINET IM 155-6 PN interface module
Max. 56 I/O modules, multi hot swap, no server module

6DL1155-6AU00-0PM0

Accessories

IM cover
Slot cover for interface module slots, to protect vacant slots
Width 50 mm, 5 units

6DL1133-6CV50-0AM0

SIMATIC PCS 7 system hardware

Process I/O

SIMATIC ET 200SP HA

Interface module

Technical specifications

Article number	6DL1155-6AU00-0PM0 ET 200SP HA, IM155-6 PN
General information	
Product type designation	IM 155-6 PN
Product function	
• I&M data	Yes; I&M0 to I&M3
Engineering with	
• STEP 7 TIA Portal configurable/ integrated from version	V16
• PCS 7 configurable/integrated from version	V9.0
Supply voltage	
Rated value (DC)	24 V
Reverse polarity protection	Yes
Short-circuit protection	Yes
Address area	
Address space per station	
• Address space per station, max.	1 440 byte; 1 440 bytes R1 and S1 without CiR, otherwise 1 000 bytes
Hardware configuration	
Integrated power supply	Yes; 24 V DC
Rack	
• Modules per rack, max.	56; 56 slots for I/O modules + server module (width without IM ≤ 1.3 m)
Time stamping	
Accuracy	1 ms; In compliance with the supplementary conditions described in the Equipment Manual
Interfaces	
Number of PROFINET interfaces	1; 2 ports (switch)
1. Interface	
Interface types	
• Number of ports	2; via BusAdapter
• integrated switch	Yes
• BusAdapter (PROFINET)	Yes; Compatible BusAdapters: BA 2x RJ45, BA 2x FC, BA 2x LC, BA LC/RJ45, BA LC/FC, BA VD
Protocols	
• PROFINET IO Device	Yes
• Open IE communication	Yes
• Media redundancy	Yes; as MRP client

Article number	6DL1155-6AU00-0PM0 ET 200SP HA, IM155-6 PN
Interface types	
RJ 45 (Ethernet)	
• Transmission procedure	PROFINET with 100 Mbit/s full duplex (100BASE-TX)
• 100 Mbps	Yes; PROFINET with 100 Mbit/ s full duplex (100BASE-TX)
• Autonegotiation	Yes
• Autocrossing	Yes
Redundancy mode	
• PROFINET system redundancy (S2)	Yes; S2, R1
Media redundancy	
- MRP	Yes
Open IE communication	
• TCP/IP	Yes
• SNMP	Yes
• LLDP	Yes
Interrupts/diagnostics/ status information	
Status indicator	Yes
Alarms	Yes
Diagnostics function	Yes
Diagnostics indication LED	
• RUN LED	Yes; green LED
• ERROR LED	Yes; red LED
• MAINT LED	Yes; Yellow LED
• ACT LED	Yes; green LED
• Monitoring of the supply voltage (PWR-LED)	Yes; green PWR LED
• Connection display LINK TX/RX	Yes; 2x green link LEDs on BusAdapter
Ambient conditions	
Ambient temperature during operation	
• horizontal installation, min.	-40 °C
• horizontal installation, max.	70 °C
• vertical installation, min.	-40 °C
• vertical installation, max.	60 °C
Dimensions	
Width	50 mm
Height	138 mm
Depth	89 mm
Weights	
Weight, approx.	192 g; without BusAdapter

Overview







- DI 16×24VDC HA digital input module
16 24 V DC digital inputs
- DI 32×24VDC HA digital input module
32 24 V DC digital inputs
- DI 16×NAMUR HA digital input module
16 NAMUR digital inputs
- DI 8×24...125VDC HA digital input module
8 24 ... 125 V DC digital inputs
- DI 8×230VAC HA digital input module
8 230 V AC digital inputs
- DQ 16×24VDC/0.5A HA digital output module
16 24 V DC digital outputs, 0.5 A
- DQ 32×24VDC/0.5A HA digital output module
32 24 V DC digital outputs, 0.5 A
- RQ 4×120VDC-230VAC/5A CO HA digital output module
4 24 ... 120 V DC, 24 ... 230 V AC relay outputs, 5 A

Design

The ET 200SP HA digital I/O modules have the following technical features:

Digital input modules

DI 16×24 V DC HA	DI 32×24 V DC HA	DI 16×NAMUR HA	DI 8×24 to 125 V DC HA	DI 8×230 V AC HA
 <ul style="list-style-type: none"> • 16 digital inputs with the following features configurable per channel: <ul style="list-style-type: none"> - Pulse stretching - Diagnostics - Input delay - Hardware interrupts for positive and negative edges • Sink input (PNP, P-reading) • Diagnostics configurable per module: no supply voltage L+ • Suitable for connecting switches and 2-wire sensors in accordance with IEC 61131-2, type 1 and 3 	 <ul style="list-style-type: none"> • Thirty-two digital inputs with the following features configurable per channel: <ul style="list-style-type: none"> - Pulse stretching - Diagnostics - Input delay - Hardware interrupts for positive and negative edges • Sink input (PNP, P-reading) • Diagnostics configurable per module: no supply voltage L+ • Suitable for connecting switches and 2-wire sensors in accordance with IEC 61131-2, type 1 and 3 	 <ul style="list-style-type: none"> • 16 digital inputs with the following features configurable per channel: <ul style="list-style-type: none"> - Pulse stretching - Hardware interrupts for positive and negative edges - Flutter monitoring • Diagnostics for changeover contact sensor types • Diagnostics configurable per channel, even in changeover contact operation • Diagnostics configurable per module: no supply voltage L+ 	 <ul style="list-style-type: none"> • Eight digital inputs isolated from the backplane bus and supply voltage L+/ M grouping 8 • Digital inputs with the following features configurable per channel: <ul style="list-style-type: none"> - Diagnostics - Input delay - Hardware interrupts for positive and negative edges • Rated input voltage range 24 V to 125 V DC • Diagnostics configurable per module: no supply voltage L+ • Suitable for connecting switches and 2-/3-/4-wire sensors in accordance with IEC 61131, type 1 and 3 	 <ul style="list-style-type: none"> • 8 isolated digital inputs in four groups (A to D) of two channels • Suitable for connecting switches and 2-wire sensors in accordance with IEC 61131, type 3

SIMATIC PCS 7 system hardware

Process I/O

SIMATIC ET 200SP HA

Digital I/O modules

Design (continued)

Digital output modules

DQ 16x24 V DC/0.5 A HA



- 16 digital outputs with the following features configurable per channel:
 - Configurable diagnostics
 - Programmable substitute values
- Source output (PNP, P-switching)
- Diagnostics configurable per module: no supply voltage L+
- Output current per channel 0.5 A
- Suitable for solenoid valves, DC contactors and indicator lights

DQ 32x24 V DC/0.5 A HA



- Thirty-two digital outputs with the following features configurable per channel:
 - Configurable diagnostics
 - Programmable substitute values
- Source output (PNP, P-switching)
- Diagnostics configurable per module: no supply voltage L+
- Output current per channel 0.5 A
- Suitable for solenoid valves, DC contactors and indicator lights

RQ 4x120 V DC-230 V AC/5 A CO HA



- 4 isolated relay outputs
- Changeover contact (CO: changeover)
- Suitable for solenoid valves, DC contactors and indicator lights
- Substitute value configurable per channel
- Diagnostics configurable per module: no supply voltage L+
- Output current per output 5 A

Ordering data

Article No.

DI 16x24VDC HA digital input module

16 24 V DC digital inputs, color code CC01, for terminal block type H1 and M1, channel diagnostics

6DL1131-6BH00-0PH1

DI 32x24VDC HA digital input module

32 24 V DC digital inputs, color code CC00, for terminal block type P0 and H1, channel diagnostics

6DL1131-6BL00-0PH1

DI 16xNAMUR HA digital input module

16 NAMUR digital inputs, color code CC01, for terminal block type H1 and M1, channel diagnostics

6DL1131-6TH00-0PH1

DI 8x24...125VDC HA digital input module

8 24 ... 125 V DC digital inputs, color code CC42, for terminal block type K0, channel diagnostics

6DL1131-6DF00-0PK0

DI 8x230VAC HA digital input module

8 230 V AC digital inputs, color code CC42, for terminal block type K0, module diagnostics

6DL1131-6GF00-0PK0

DQ 16x24VDC/0.5A HA digital output module

16 24 V DC digital outputs, 0.5 A, color code CC02, for terminal block type H1 and M1, channel diagnostics

6DL1132-6BH00-0PH1

DQ 32x24VDC/0.5A HA digital output module

32 24 V DC digital outputs, 0.5 A, color code CC00, for terminal block type N0 and H1, channel diagnostics

6DL1132-6BL00-0PH1

RQ 4x120VDC-230VAC/5A CO HA digital output module

4 24 ... 120 V DC, 24 ... 230 V AC relay outputs, 5 A, color code CC40, for terminal block type K0, module diagnostics

6DL1132-6HD50-0PK0

Article No.

Accessories

Labeling strips

For labeling the I/O modules

- Roll, light gray (with a total of 500 labeling strips), 1 unit
- DIN A4 sheet, light gray, 10 items per packing unit, 45 labeling strips per sheet (450)
- DIN A4 sheet, yellow, 10 items per packing unit, 45 labeling strips per sheet (450)

6DL1193-6LR00-0AA0

6DL1193-6LA00-0AA0

6DL1193-6LA00-0AG0

Color-coded labels

For push-in terminals

- Color code CC01, 10 units gray (terminals 1 to 16), red (terminals 17 to 32)
- Color code CC02, 10 units gray (terminals 1 to 16), blue (terminals 17 to 32)
- Color code CC40, 10 units gray (terminals 1 to 16)
- Color code CC42, 10 units gray (terminals 1 to 8), blue (terminals 9 to 16)

6DL1193-6CP01-2HH1

6DL1193-6CP02-2HH1

6DL1193-6CP40-2HK0

6DL1193-6CP42-2HK0

Equipment labeling plates

10 sheets with 16 labels each

6ES7193-6LF30-0AW0

TM cover

Slot cover for I/O modules, to protect vacant I/O slots

Width 22.5 mm, 5 units

6DL1133-6CV22-0AM0

Technical specifications

Article number	6DL1131-6GF00-0PK0 ET 200SP HA, DI 8x230VAC	6DL1131-6BH00-0PH1 ET 200SP HA, DI 16x24VDC	6DL1131-6BL00-0PH1 ET 200SP HA, DI 32x24VDC	6DL1131-6DF00-0PK0 ET 200SP HA, DI 8x24 ... 125VDC	6DL1131-6TH00-0PH1 ET 200SP HA, DI 16xNAMUR
General information					
Product type designation	DI 8x230VAC HA	DI 16x24VDC HA	DI 32x24VDC HA	DI 8x24 ... 125 V DC HA	DI 16xNAMUR HA
Engineering with					
• STEP 7 TIA Portal configurable/integrated from version	V16	V16	V16	V16	V16
• PCS 7 configurable/integrated from version	V9.0	V9.0	V9.0	V9.0	V9.0
• PROFINET from GSD version/ GSD revision	GSDML V2.3	GSDML V2.3	GSDML V2.3	GSDML V2.3	GSDML V2.3
Operating mode					
• DI	Yes	Yes	Yes	Yes	Yes
• Counter		No	No	No	No
• Oversampling		No	No	No	No
• MSI		No	No	No	No
Supply voltage					
Rated value (DC)		24 V	24 V	24 V	24 V
Rated value (AC)	230 V				
Reverse polarity protection		Yes	Yes	Yes	Yes
Encoder supply					
Number of outputs		16	32; When terminal block with encoder supply is used (type P0)		16
Short-circuit protection		Yes; electronic (response threshold 0.7 A to 1.3 A; for IO redundancy up to 2.6 A) Ensure sufficient low-resistance cable routing to the sensor/actuator in order to attain the response threshold. Depending on the cable cross-section used, there may be constraints regarding the usable length of cable	Yes; When using TB type P0		Yes
Output current					
• up to 60 °C, max.		2 A; 1 A when mounted vertically; see derating information in Equipment Manual			
• up to 70 °C, max.		1 A; See derating information in Equipment Manual			
24 V encoder supply					
• 24 V		Yes			
• Short-circuit protection		Yes; electronic (response threshold 0.7 A to 1.3 A; for IO redundancy up to 2.6 A) Ensure sufficient low-resistance cable routing to the sensor/actuator in order to attain the response threshold. Depending on the cable cross-section used, there may be constraints regarding the usable length of cable			
• Output current per channel, max.		0.5 A			
• Output current per module, max.		2 A			

SIMATIC PCS 7 system hardware

Process I/O

SIMATIC ET 200SP HA

Digital I/O modules

Technical specifications (continued)

Article number	6DL1131-6GF00-0PK0 ET 200SP HA, DI 8X230VAC	6DL1131-6BH00-0PH1 ET 200SP HA, DI 16X24VDC	6DL1131-6BL00-0PH1 ET 200SP HA, DI 32X24VDC	6DL1131-6DF00-0PK0 ET 200SP HA, DI 8X24 ... 125VDC	6DL1131-6TH00-0PH1 ET 200SP HA, DI 16XNAMUR
Digital inputs					
Number of digital inputs	8; Isolated	16	32	8	16; NAMUR
Digital inputs, parameterizable		Yes	Yes		Yes
Source/sink input		Yes; P-reading	Yes; P-reading	Yes; P-reading	
Input characteristic curve in accordance with IEC 61131, type 1		Yes	Yes	Yes	
Input characteristic curve in accordance with IEC 61131, type 2		No	No		
Input characteristic curve in accordance with IEC 61131, type 3	Yes	Yes	Yes	Yes	
Pulse extension		Yes	No		Yes; 0.5 s, 1 s, 2 s
• Length		off, 50 ms, 100 ms, 200 ms, 500 ms, 1 s, 2 s			
Time stamping		Yes; Resolution 10 ms		Yes; Resolution 10 ms	Yes
Time stamp (with precision of 1 ms)		Yes; Resolution 1ms		Yes; Resolution 1ms	No
Edge evaluation		Yes; rising edge, falling edge, edge change	Yes; rising edge, falling edge, edge change		Yes; rising edge, falling edge, edge change
Signal change flutter					Yes; 2 to 32 signal changes
Flutter observation window					Yes; 0.5 s, 1 s to 100 s in 1-s steps
Input voltage					
• Rated value (DC)		24 V	24 V		8.2 V
• Rated value (AC)	230 V				
• for signal "0"	0V AC to 40V AC	-30 to +5 V	-30 to +5 V	-125 ... +5 V	
• for signal "1"	74 V AC to 264 V AC	+11 to +30V	+11 to +30V	+11 ... +125 V	
Input current					
• for signal "1", typ.	10.8 mA	2.5 mA	2.5 mA	3.1 mA	
for 10 k switched contact					
- for signal "0"					0.35 to 1.2 mA
- for signal "1"					2.1 ... 6.4 mA
for unswitched contact					
- for signal "0", max. (permissible quiescent current)					0.5 mA
- for signal "1"					typ. 8 mA
for NAMUR encoders					
- for signal "0"					0.35 to 1.2 mA
- for signal "1"					2.1 ... 6.4 mA
Input delay (for rated value of input voltage)					
• tolerated changeover time for changeover contacts					300 ms
for standard inputs					
- parameterizable		Yes; none / 0.05 / 0.1 / 0.4 / 0.8 / 1.6 / 3.2 / 12.8 / 20 ms	No	Yes; 0.05 / 0.1 / 0.4 / 0.8 / 1.6 / 3.2 / 12.8 / 20 ms (in each case + delay of 30 to 500 µs, depending on line length)	
Encoder					
Connectable encoders					
• NAMUR encoder/changeover contact according to EN 60947					Yes
• Single contact / changeover contact unconnected					Yes
• Single contact / changeover contact connected with 10 kΩ					Yes
• 2-wire sensor	Yes	Yes	Yes	Yes	Yes; Acc. to NAMUR
- permissible quiescent current (2-wire sensor), max.		1.5 mA	1.5 mA	1.5 mA	1.2 mA

Technical specifications (continued)

Article number	6DL1131-6GF00-0PK0 ET 200SP HA, DI 8X230VAC	6DL1131-6BH00-0PH1 ET 200SP HA, DI 16X24VDC	6DL1131-6BL00-0PH1 ET 200SP HA, DI 32X24VDC	6DL1131-6DF00-0PK0 ET 200SP HA, DI 8X24 ... 125VDC	6DL1131-6TH00-0PH1 ET 200SP HA, DI 16XNAMUR
Interrupts/diagnostics/ status information					
Diagnostics function		Yes	Yes		
Alarms					
• Diagnostic alarm	Yes	Yes; channel by channel	Yes; channel by channel	Yes	Yes; channel by channel
• Hardware interrupt		Yes; channel by channel	Yes; channel by channel	Yes; Parameterizable, channels 0 to 7, rising/falling edge	Yes; Parameterizable, channels 0 to 15, rising/falling edge
Diagnoses					
• Diagnostic information readable	Yes	Yes	Yes	Yes	Yes
• Monitoring the supply voltage - parameterizable		Yes; Module-wise	Yes; Module-wise	Yes	Yes
• Monitoring of encoder power supply		Yes	Yes		Yes
• Wire-break		Yes; Channel-by-channel, optional protective circuit for preventing wire-break diagnostics in the case of simple encoder contacts: 15 kOhm to 18 kOhm	Yes; Channel-by-channel, optional protective circuit for preventing wire-break diagnostics in the case of simple encoder contacts: 15 kOhm to 18 kOhm	Yes; channel by channel	Yes
• Short-circuit			No		Yes
• Short-circuit to M		Yes; Encoder supply to M, channel by channel			
• Group error				Yes	Yes
• Changeover contact error					Yes
Diagnostics indication LED					
• MAINT LED	Yes; Yellow LED	Yes; Yellow LED	Yes; Yellow LED	Yes; Yellow LED	Yes; Yellow LED
• Monitoring of the supply voltage (PWR-LED)		Yes; green PWR LED	Yes; green PWR LED	Yes; green PWR LED	Yes; green PWR LED
• Channel status display	Yes; green LED	Yes; green LED	Yes; green LED	Yes; green LED	Yes; green LED
• for channel diagnostics		Yes; red LED	No	Yes; red LED	Yes; red LED
• for module diagnostics	Yes; green/red DIAG LED	Yes; green/red LED	Yes; green/red DIAG LED	Yes; green/red DIAG LED	Yes; green/red DIAG LED
Potential separation					
Potential separation channels					
• between the channels and backplane bus	Yes	Yes	Yes	Yes	Yes
Ambient conditions					
Ambient temperature during operation					
• horizontal installation, min.	-40 °C	-40 °C	-40 °C	-40 °C	-40 °C
• horizontal installation, max.	70 °C	70 °C	70 °C	70 °C	70 °C
• vertical installation, min.	-40 °C	-40 °C	-40 °C	-40 °C	-40 °C
• vertical installation, max.	60 °C	60 °C	60 °C	60 °C	60 °C
Dimensions					
Width	22.5 mm	22.5 mm	22.5 mm	22.5 mm	22.5 mm
Height	115 mm	115 mm	115 mm	115 mm	115 mm
Depth	138 mm	138 mm	138 mm	138 mm	138 mm
Weights					
Weight, approx.	148 g	135 g	150 g	165 g	153 g

SIMATIC PCS 7 system hardware

Process I/O

SIMATIC ET 200SP HA

Digital I/O modules**Technical specifications (continued)**

Article number	6DL1132-6BH00-0PH1 ET 200SP HA, DQ 16x24VDC/0,5A	6DL1132-6BL00-0PH1 ET 200SP HA, DQ 32x24VDC/0,5A	6DL1132-6HD50-0PK0 ET 200SP HA, RQ 4x120VDC- 230VAC/5A CO
General information			
Product type designation	DQ 16x24VDC/0.5A HA	DQ 32x24VDC/0.5A HA	RQ 4x120 V UC ... 230 V AC/5 A CO HA
Engineering with			
• STEP 7 TIA Portal configurable/ integrated from version	V16	V16	V16
• PCS 7 configurable/integrated from version	V9.0	V9.0	V9.0
• PROFINET from GSD version/ GSD revision	GSDML V2.3	GSDML V2.3	GSDML V2.3
Operating mode			
• DQ	Yes	Yes	
• DQ with energy-saving function	No	No	
• PWM	No	No	
• Oversampling	No	No	
• MSO	No		
Supply voltage			
Rated value (DC)	24 V	24 V	24 V
Reverse polarity protection	Yes	Yes	Yes
Digital outputs			
Number of digital outputs	16	32	4
Current-sinking	No	No	
Current-sourcing	Yes	Yes	
Digital outputs, parameterizable	Yes	Yes	
Short-circuit protection	Yes; Ensure sufficient low-resistance cable routing to the sensor/actuator in order to attain the response threshold. Depending on the cable cross-section used, there may be constraints regarding the usable length of cable.	Yes; Clocked electronically	
Open-circuit detection	Yes; 0.7 mA test current for wire-break diagnostics; this value is doubled in the case of IO redundancy	No	
Overload protection	Yes	Yes	
Limitation of inductive shutdown voltage to	L+ -(37 to 41V)	Typ. L+ (-53 V)	
Controlling a digital input	Yes	Yes	
Switching capacity of the outputs			
• with resistive load, max.	0.5 A	0.5 A	
• on lamp load, max.	5 W	5 W	
Load resistance range			
• lower limit	48 Ω	48 Ω	
• upper limit	12 kΩ	4 kΩ	
Output current			
• for signal "1" rated value	0.5 A	0.5 A	
• for signal "0" residual current, max.	0.7 mA; Test current for wire-break diagnostics; this value is doubled in the case of IO redundancy	0.1 mA	
Output delay with resistive load			
• "0" to "1", typ.	50 μs	54 μs	
• "1" to "0", typ.	100 μs	48 μs	
Parallel switching of two outputs			
• for uprating	No	No	
• for redundant control of a load	Yes	Yes; only outputs of the same group	

Technical specifications (continued)

Article number	6DL1132-6BH00-0PH1 ET 200SP HA, DQ 16X24VDC/0,5A	6DL1132-6BL00-0PH1 ET 200SP HA, DQ 32X24VDC/0,5A	6DL1132-6HD50-0PK0 ET 200SP HA, RQ 4X120VDC- 230VAC/5A CO
Switching frequency			
• with resistive load, max.	100 Hz	100 Hz	2 Hz
• with inductive load, max.	2 Hz	2 Hz	0.5 Hz
• on lamp load, max.	10 Hz	10 Hz	2 Hz
Total current of the outputs			
• Current per channel, max.	0.5 A	0.5 A	
• Current per module, max.	8 A	10 A	
Total current of the outputs (per module)			
horizontal installation			
- up to 30 °C, max.	8 A		
- up to 40 °C, max.	8 A		
- up to 50 °C, max.	8 A		
- up to 60 °C, max.	5.5 A		
- up to 70 °C, max.	3 A	10 A	
vertical installation			
- up to 30 °C, max.	8 A		
- up to 40 °C, max.	6.33 A		
- up to 50 °C, max.	4.67 A		
- up to 60 °C, max.	3 A	10 A	
Relay outputs			
• Number of relay outputs			4
• external protection for relay outputs			yes; 6 A, see data in manual
Switching capacity of contacts			
- with inductive load, max.			2 A; 2 A (24 V DC), 0.5 A (60 V DC), 0.1 A (120 V DC)
- with resistive load, max.			5 A; 5 A (30 V DC), 5 A (230 V AC)
- Switching current, min.			8 mA
- Rated switching voltage (DC)			24 V; 24 V DC to 120 V DC
- Rated switching voltage (AC)			230 V; 24V AC to 230V AC
Cable length			
• shielded, max.	1 000 m	1 000 m	1 000 m
• unshielded, max.	600 m	600 m	200 m
Interrupts/diagnostics/ status information			
Diagnostics function	Yes	Yes	Yes
Substitute values connectable	Yes	Yes	Yes
Alarms			
• Diagnostic alarm	Yes	Yes	Yes
Diagnoses			
• Monitoring the supply voltage	Yes	Yes	Yes
- parameterizable		Yes	Yes
• Wire-break	Yes; channel by channel	No	
• Short-circuit		Yes	
• Short-circuit to M	Yes; channel by channel	Yes; channel by channel	
• Short-circuit to L+	Yes; channel by channel	No	
• Group error	Yes	Yes	
Diagnostics indication LED			
• MAINT LED	Yes; Yellow LED	Yes; Yellow LED	Yes; Yellow LED
• Monitoring of the supply voltage (PWR-LED)	Yes; green PWR LED	Yes; green PWR LED	Yes; green PWR LED
• Channel status display	Yes; green LED	Yes; green LED	Yes; green LED
• for channel diagnostics	Yes; red LED	No	
• for module diagnostics	Yes; green/red DIAG LED	Yes; green/red DIAG LED	Yes; green/red DIAG LED

SIMATIC PCS 7 system hardware

Process I/O

SIMATIC ET 200SP HA

Digital I/O modules**Technical specifications** (continued)

Article number	6DL1132-6BH00-0PH1 ET 200SP HA, DQ 16X24VDC/0,5A	6DL1132-6BL00-0PH1 ET 200SP HA, DQ 32X24VDC/0,5A	6DL1132-6HD50-0PK0 ET 200SP HA, RQ 4X120VDC- 230VAC/5A CO
Potential separation			
Potential separation channels			
• between the channels and backplane bus	Yes	Yes	Yes
Ambient conditions			
Ambient temperature during operation			
• horizontal installation, min.	-40 °C	-40 °C	-40 °C; No icing
• horizontal installation, max.	70 °C	70 °C	70 °C
• vertical installation, min.	-40 °C	-40 °C	-40 °C; No icing
• vertical installation, max.	60 °C	60 °C	60 °C
Altitude during operation relating to sea level			
• Ambient air temperature-barometric pressure-altitude			3 000 m due to converter type used
Dimensions			
Width	22.5 mm	22.5 mm	22.5 mm
Height	115 mm	115 mm	115 mm
Depth	138 mm	138 mm	138 mm
Weights			
Weight, approx.	137 g	150 g	162 g

Accessories**Slot cover, labeling strips**

A slot cover is inserted in a terminal block:

- When slots do not contain I/O modules
- If slots are reserved for future expansion (empty)

You can insert a labeling strip for the planned I/O module in the front of the slot cover. The labeling strips can be ordered as accessories:

- For thermal transfer printers on a roll
- For laser printers as A4 sheets

Color-coding system

Color-coded labels facilitate cable assignment and identification of the potentials of an I/O module. A color code (for example CC01) is printed on each color coding label and I/O module. The color code can be read straight off the I/O module to determine which color-coded label you need for the terminal block.

The reference identification labels in accordance with EN 81346 can be attached to interface modules, BusAdapters and I/O modules. With the standard markings for printing, the reference identification label is suitable for automatic labeling with E-CAD systems.

Overview



- Analog input module AI 16xI 2-wire HART HA
16 analog inputs
Measuring range 0 to 20 mA, 0 to 10 mA, 4 to 20 mA, 4 to 20 mA with HART
- Analog input module AI 16xTC/8xRTD 2-/3-/4-wire HA
16 analog inputs for thermocouples; alternatively
8 analog inputs for thermistors
- AQ 8xI HART HA analog output module
8 analog outputs
Power output in the output ranges 0 to 10 mA, 0 to 20 mA, 4 to 20 mA and 4 to 20 mA HART
- Analog input module AI 4XI 2-/4-wire HART ISOL
4 galvanically isolated analog inputs (2-/4-wire)
- Analog output module AQ 4XI HART ISOL
4 galvanically isolated analog outputs (2-wire)

Design

The ET 200SP HA analog I/O modules have the following technical features:

Analog input modules

AI 16xI 2-wire HART HA



- 16 analog inputs
- 16 outputs as encoder supply for 2-wire transducer
- The analog inputs have the following features, configurable per channel:
 - Current measurement type for 2-wire HART measuring transducer
 - Measuring range 0 to 20 mA, 0 to 10 mA, 4 to 20 mA and 4 to 20 mA with HART
 - Resolution depends on measuring range and interference frequency suppression; minimum of 15 bits including sign, maximum of 16 bits including sign
 - Smoothing
 - Interference frequency suppression 10 Hz, 50 Hz and 60 Hz
- Diagnostics configurable per channel
- Diagnostics configurable per module: no supply voltage L+
- Hardware interrupt

AI 16xTC/8xRTD 2-/3-/4-wire HA



- 16 analog inputs for connecting thermocouples (TC)
- Alternatively 8 analog inputs for connecting thermistors (RTD)
- The analog inputs have the following features, configurable per channel:
 - Resolution: 16 bits including sign
 - "Voltage" measurement type
 - "Resistance" measurement type, 2-/3-/4-wire connection
 - "Thermistor" (RTD) measurement type, 2-/3-/4-wire connection
 - "Thermocouple" (TC) measurement type can be set per channel
 - Smoothing
 - Interference frequency suppression 16.6 Hz, 50 Hz or 60 Hz
- Diagnostics configurable per channel
- Diagnostics configurable per module: no supply voltage L+
- Permissible common mode voltage between channels: 75 V DC / 60 V AC
- Temperature compensation:
 - Reference channel of the module
 - Internal reference junction
 - Fixed temperature (0 °C)
- Conversion time depends on interference frequency suppression of 16.6/50/60 Hz at 180/60/50 ms that can be set by channel. (With 3-wire measuring transducers, the time is twice as long as 2 measurements are required per channel).
- Max. cable length RTD, TC: 600 m
- Hardware interrupt on limit violation per channel (two high and two low limits per channel)
- Automatic compensation of line resistances with 3-wire connections

AI 4XI 2-/4-Wire HART ISOL



- 4 galvanically isolated analog inputs (2-/4-wire)
- Electric potential difference up to 125 V AC / 150 V DC (between the channels) and 125 V AC / 150 V DC (between channels and backplane bus)
- Inputs:
 - 0 ... 10 mA, 0 ... 20 mA, 4 ... 20 mA, 4 ... 20 mA with HART
 - 4x sensor supply with short-circuit limitation 24 mA
 - A/D conversion with 16-bit resolution
 - 4x HART modems with parallel processing, up to 16 HART variables
- Redundancy:
 - I/O redundancy with terminal module type L0
- Channel-selective diagnostics:
 - Sensor supply, short-circuit to ground, wire break, short-circuit between sensor supply and input, overflow and underflow

SIMATIC PCS 7 system hardware

Process I/O

SIMATIC ET 200SP HA

Analog I/O modules

Design (continued)

Analog output modules

AQ 8xI HART HA



- Analog output module with 8 outputs (8 D/A converters operating in parallel)
- Current output in output ranges 0 to 10 mA, 0 to 20 mA, 4 to 20 mA and 4 to 20 mA HART
- Resolution 16 bits including sign
- Rated supply voltage 24 V DC
- Load max. 750 Ω, max. 10 mH
- Diagnostics configurable per channel
- Diagnostics configurable per module: no supply voltage L+

AQ 4XI HART ISOL



- 4 galvanically isolated analog outputs (2-wire)
- Electric potential difference up to 125 V AC / 150 V DC (between the channels) and 125 V AC / 150 V DC (between channels and backplane bus)
- Inputs:
 - 0 ... 10 mA, 0 ... 20 mA, 4 ... 20 mA, 4 ... 20 mA with HART
 - A/D conversion with 16-bit resolution
 - 4x HART modems with parallel processing, up to 16 HART variables
- Redundancy:
 - I/O redundancy with terminal module type L0
- Channel-selective diagnostics:
 - Short-circuit to ground, wire break, overflow and underflow

Ordering data

Article No.

**Analog input module
AI 16xI 2-wire HART HA**
16 analog inputs
Measuring range 0 to 20 mA,
0 to 10 mA, 4 to 20 mA, 4 to 20 mA
with HART
Color code CC01, for terminal block
type H1 and M1, channel
diagnostics, 16-bit

6DL1134-6TH00-0PH1

**Analog input module
AI 16xTC/8xRTD 2-/3-/4-wire HA**
16 analog inputs for
thermocouples, alternatively
8 analog inputs for thermistors
Color code CC00, for terminal block
type H1 and M1, channel
diagnostics, 16-bit

6DL1134-6JH00-0PH1

**AQ 8xI HART HA analog output
module**
8 analog outputs
Power output in the output ranges
0 to 10 mA, 0 to 20 mA, 4 to 20 mA
and 4 to 20 mA HART
Color code CC00, for terminal block
type H1 and M1, channel diagnos-
tics, 16-bit

6DL1135-6TF00-0PH1

**AI 4XI 2-/4-wire HART ISOL
analog input module**
14 analog inputs
Color code CC01, for terminal block
type K0, L0, channel diagnostics,
16-bit, +/-0.1%

6DL1134-6UD00-0PK0

**AQ 4XI HART ISOL
analog output module**
4 analog outputs
Color code CC00, for terminal block
type K0, L0, channel diagnostics,
16-bit, +/-0.1%

6DL1135-6UD00-0PK0

Article No.

Accessories

Labeling strips

For labeling the I/O modules

- Roll, light gray (with a total of 500 labeling strips), 1 unit
- DIN A4 sheet, light gray, 10 items per packing unit, 45 labeling strips per sheet (450)
- DIN A4 sheet, yellow, 10 items per packing unit, 45 labeling strips per sheet (450)

6DL1193-6LR00-0AA0

6DL1193-6LA00-0AA0

6DL1193-6LA00-0AG0

Color-coded labels

For push-in terminals

- Color code CC00, 10 units gray (terminals 1 to 32)
- Color code CC01, 10 units gray (terminals 1 to 16), red (terminals 17 to 32)

6DL1193-6CP00-2HH1

6DL1193-6CP01-2HH1

Equipment labeling plates
10 sheets with 16 labels each

6ES7193-6LF30-0AW0

TM cover

Slot cover for I/O modules,
to protect vacant I/O slots

Width 22.5 mm, 5 units

6DL1133-6CV22-0AM0

15

Technical specifications

Article number	6DL1134-6JH00-0PH1 ET 200SP HA, AI 16XTC/8XRTD 2-/3-/4-WIRE	6DL1134-6TH00-0PH1 ET 200SP HA, AI 16XI 2-WIRE HART
General information		
Product type designation	AI 16 x TC/8 x RTD 2/3/4-wire HA	AI 16 x I 2-wire mA HART
Engineering with		
• STEP 7 TIA Portal configurable/integrated from version	V16	V16
• STEP 7 configurable/integrated from version	V5.6	V5.6
• PCS 7 configurable/integrated from version	V9.0	V9.0
• PCS neo can be configured/integrated from version	V3.0	V3.0
• PROFINET from GSD version/GSD revision	GSDML V2.3	GSDML V2.3
Supply voltage		
Rated value (DC)	24 V	24 V
Reverse polarity protection	Yes	Yes
Analog inputs		
Number of analog inputs		16
• For voltage measurement	16	
• For resistance/resistance thermometer measurement	8	
• For thermocouple measurement	16	
permissible input voltage for voltage input (destruction limit), max.	5 V	
permissible input current for current input (destruction limit), max.		30 mA
Constant measurement current for resistance-type transmitter, typ.	2 mA	
Technical unit for temperature measurement adjustable	Yes; °C/°F/K	
Input ranges (rated values), voltages		
• -1 V to +1 V	Yes; 16 bit incl. sign	
• -250 mV to +250 mV	Yes; 16 bit incl. sign	
• -50 mV to +50 mV	Yes; 16 bit incl. sign	
• -80 mV to +80 mV	Yes; 16 bit incl. sign	
Input ranges (rated values), currents		
• 0 to 20 mA		Yes; 16 bit incl. sign
• 4 mA to 20 mA		Yes; 16 bit incl. sign
Input ranges (rated values), thermocouples		
• Type B	Yes; 16 bit incl. sign	
• Type C	Yes; 16 bit incl. sign	
• Type E	Yes; 16 bit incl. sign	
• Type J	Yes; 16 bit incl. sign	
• Type K	Yes; 16 bit incl. sign	
• Type L	Yes; 16 bit incl. sign	
• Type N	Yes; 16 bit incl. sign	
• Type R	Yes; 16 bit incl. sign	
• Type S	Yes; 16 bit incl. sign	
• Type T	Yes; 16 bit incl. sign	
• Type U	Yes; 16 bit incl. sign	
• Type TXK/TXK(L) to GOST	Yes; 16 bit incl. sign	

SIMATIC PCS 7 system hardware

Process I/O

SIMATIC ET 200SP HA

Analog I/O modules

Technical specifications (continued)

Article number	6DL1134-6JH00-0PH1 ET 200SP HA, AI 16XTC/8XRTD 2-/3-/4-WIRE	6DL1134-6TH00-0PH1 ET 200SP HA, AI 16XI 2-WIRE HART
Input ranges (rated values), resistance thermometer		
• Cu 10	Yes; 16 bit incl. sign	
• Ni 100	Yes; 16 bit incl. sign	
• Ni 1000	Yes; 16 bit incl. sign	
• LG-Ni 1000	Yes; 16 bit incl. sign	
• Ni 120	Yes; 16 bit incl. sign	
• Ni 200	Yes; 16 bit incl. sign	
• Ni 500	Yes; 16 bit incl. sign	
• Pt 100	Yes; 16 bit incl. sign	
• Pt 1000	Yes; 16 bit incl. sign	
• Pt 200	Yes; 16 bit incl. sign	
• Pt 500	Yes; 16 bit incl. sign	
Input ranges (rated values), resistors		
• 0 to 150 ohms	Yes; 15 bit	
• 0 to 300 ohms	Yes; 15 bit	
• 0 to 600 ohms	Yes; 15 bit	
• 0 to 3000 ohms	Yes; 15 bit	
• 0 to 6000 ohms	Yes; 15 bit	
• PTC	Yes; 15 bit	
Thermocouple (TC)		
Temperature compensation		
- parameterizable	Yes	
Cable length		
• shielded, max.	200 m; Measurement ranges for thermocouples / voltages: shielded cable length max. 600 m, loop resistance max 8 kOhm; measuring ranges RTD: shielded cable length max. 600 m, cable resistance (single) max. 75 ohms	800 m; with unshielded cables up to 800 m, remember that (external) EMC loads can cause incorrect measured values
Analog value generation for the inputs		
Integration and conversion time/resolution per channel		
• Resolution with overrange (bit including sign), max.	16 bit	16 bit; 15 bit at 0 ... 10 mA and 60 Hz interference suppression
• Integration time, parameterizable	Yes; Channel-by-channel, results from the selected interference frequency suppression	Yes; channel by channel
• Interference voltage suppression for interference frequency f1 in Hz	16.6 / 50 / 60 Hz, channel-by-channel	
• Conversion time (per channel)	60 ms; 180 / 50 ms, results from the selected interference frequency suppression	
Smoothing of measured values		
• parameterizable	Yes; none, weak, medium, strong, channel-by-channel	Yes; none, weak, medium, strong, channel-by-channel
Encoder		
Connection of signal encoders		
• for current measurement as 2-wire transducer		Yes
Errors/accuracies		
Basic error limit (operational limit at 25 °C)		
• Voltage, relative to input range, (+/-)	0.05 %	
• Current, relative to input range, (+/-)		0.1 %
• Resistance, relative to input range, (+/-)	0.05 %	
Interference voltage suppression for f = n x (f1 +/- 1 %), f1 = interference frequency		
• Series mode interference (peak value of interference < rated value of input range), min.	70 dB	
• Common mode voltage, max.	60 V	
• Common mode interference, min.	90 dB	

Technical specifications (continued)

Article number	6DL1134-6JH00-0PH1	6DL1134-6TH00-0PH1
	ET 200SP HA, AI 16XTC/8XRTD 2-/3-/4-WIRE	ET 200SP HA, AI 16XI 2-WIRE HART
Interrupts/diagnostics/status information		
Diagnostics function	Yes	Yes
Alarms		
• Diagnostic alarm	Yes	Yes
• Limit value alarm	Yes; two upper and two lower limit values in each case	Yes; two upper and two lower limit values in each case
Diagnoses		
• Monitoring the supply voltage	Yes	Yes
• Wire-break	Yes; channel by channel	Yes; channel by channel
• Short-circuit		Yes; Channel-by-channel, short-circuit of the encoder supply to ground or of an input to the encoder supply
• Overflow/underflow	Yes; channel by channel	Yes; channel by channel
Diagnostics indication LED		
• MAINT LED	Yes; Yellow LED	Yes; Yellow LED
• Monitoring of the supply voltage (PWR-LED)	Yes; green PWR LED	Yes; green PWR LED
• Channel status display	Yes; green LED	Yes; green LED
• for channel diagnostics	Yes; red LED	Yes; red LED
• for module diagnostics	Yes; green/red DIAG LED	Yes; green/red DIAG LED
Potential separation		
Potential separation channels		
• between the channels and backplane bus	Yes	Yes
Ambient conditions		
Ambient temperature during operation		
• horizontal installation, min.	-40 °C	-40 °C
• horizontal installation, max.	70 °C	70 °C; Observe derating
• vertical installation, min.	-40 °C	-40 °C
• vertical installation, max.	60 °C	60 °C; Observe derating
Dimensions		
Width	22.5 mm	22.5 mm
Height	115 mm	115 mm
Depth	138 mm	138 mm
Weights		
Weight, approx.	150 g	148 g

SIMATIC PCS 7 system hardware

Process I/O

SIMATIC ET 200SP HA

Analog I/O modules

Technical specifications (continued)

Article number	6DL1135-6TF00-0PH1 ET 200SP HA, AQ 8XI HART
General information	
Product type designation	AQ 8 x I HART HA
Engineering with	
• STEP 7 TIA Portal configurable/integrated from version	V16
• STEP 7 configurable/integrated from version	V5.6
• PCS 7 configurable/integrated from version	V9.0
• PCS neo can be configured/integrated from version	V3.0
• PROFINET from GSD version/GSD revision	GSDML V2.3
Supply voltage	
Rated value (DC)	24 V
Reverse polarity protection	Yes
Analog outputs	
Number of analog outputs	8; short-circuit proof with respect to ground
Output ranges, current	
• 0 to 10 mA	Yes; 14 bit
• 0 to 20 mA	Yes; 15 bit
• -20 mA to +20 mA	No
• 4 mA to 20 mA	Yes; 16 bit incl. sign
Connection of actuators	
• for current output two-wire connection	Yes
Load impedance (in rated range of output)	
• with current outputs, max.	750 Ω
• with current outputs, inductive load, max.	10 mH
Cable length	
• shielded, max.	1 000 m; with unshielded cables up to 800 m, remember that (external) EMC loads can cause incorrect measured values
Settling time	
• for resistive load	1.2 ms; 750 ohm
• for inductive load	1.2 ms
Errors/accuracies	
Basic error limit (operational limit at 25 °C)	
• Current, relative to output range, (+/-)	0.1 %
Interrupts/diagnostics/status information	
Diagnostics function	Yes
Substitute values connectable	Yes
Alarms	
• Diagnostic alarm	Yes
Diagnoses	
• Monitoring the supply voltage	Yes
• Wire-break	Yes; channel by channel
• Short-circuit	Yes; channel by channel
• Overflow/underflow	Yes; channel by channel
Diagnostics indication LED	
• MAINT LED	Yes; Yellow LED
• Monitoring of the supply voltage (PWR-LED)	Yes; green PWR LED
• Channel status display	Yes; green LED
• for channel diagnostics	Yes; red LED
• for module diagnostics	Yes; green/red DIAG LED

Article number	6DL1135-6TF00-0PH1 ET 200SP HA, AQ 8XI HART
Potential separation	
Potential separation channels	Yes
• between the channels and backplane bus	
Ambient conditions	
Ambient temperature during operation	
• horizontal installation, min.	-40 °C
• horizontal installation, max.	70 °C
• vertical installation, min.	-40 °C
• vertical installation, max.	60 °C
Dimensions	
Width	22.5 mm
Height	115 mm
Depth	138 mm
Weights	
Weight, approx.	160 g

Article number	6DL1134-6UD00-0PK0 ET 200SP HA, AI 4XI 2-/4-Wire HART ISOL
General information	
Product type designation	AI 4xI 2-/4-wire HART ISOL HA
Engineering with	
• PROFIBUS from GSD version/GSD revision	Yes / Yes
• PROFINET from GSD version/GSD revision	Yes / Yes
Supply voltage	
Rated value (DC)	24 V
Reverse polarity protection	Yes
Analog inputs	
Number of analog inputs	4
• For current measurement	4
permissible input current for current input (destruction limit), max.	24 mA
Input ranges (rated values), currents	
• 0 to 20 mA	Yes; 16 bit incl. sign
• 4 mA to 20 mA	Yes; 16 bit incl. sign
Cable length	
• shielded, max.	800 m; with unshielded cables up to 800 m, remember that (external) EMC loads can cause incorrect measured values
Analog value generation for the inputs	
Integration and conversion time/resolution per channel	
• Resolution with overrange (bit including sign), max.	16 bit; 14 bit at 60 Hz (0 ... 10 mA), 16 bit at 10 Hz, 15 bit at 50 Hz and 15 bit at 60 Hz interference suppression
Smoothing of measured values	
• parameterizable	Yes; none, weak, medium, strong, channel-by-channel
Encoder	
Connection of signal encoders	
• for current measurement as 2-wire transducer	Yes
Errors/accuracies	
Basic error limit (operational limit at 25 °C)	
• Current, relative to input range, (+/-)	0.1 %

Technical specifications (continued)

Article number	6DL1134-6UD00-0PK0 ET 200SP HA, AI 4XI 2-/4-Wire HART ISOL
Interrupts/diagnostics/ status information	
Diagnostics function	Yes
Alarms	
• Diagnostic alarm	Yes
• Limit value alarm	Yes; two upper and two lower limit values in each case
Diagnoses	
• Monitoring the supply voltage	Yes
• Wire-break	Yes; channel by channel
• Short-circuit	Yes; Channel-by-channel, short-cir- cuit of the encoder supply to ground or of an input to the encoder supply
• Overflow/underflow	Yes; channel by channel
Diagnostics indication LED	
• MAINT LED	Yes; Yellow LED
• Monitoring of the supply voltage (PWR-LED)	Yes; green PWR LED
• Channel status display	Yes; green LED
• for channel diagnostics	Yes; red LED
• for module diagnostics	Yes; green/red DIAG LED
Potential separation	
Potential separation channels	
• between the channels and backplane bus	Yes; 125 V AC / 150 V DC
Ambient conditions	
Ambient temperature during operation	
• horizontal installation, min.	-40 °C
• horizontal installation, max.	70 °C; Observe derating
• vertical installation, min.	-40 °C
• vertical installation, max.	70 °C; Observe derating
Dimensions	
Width	22.5 mm
Height	115 mm
Depth	138 mm
Weights	
Weight, approx.	163 g
Article number	6DL1135-6UD00-0PK0 ET 200SP HA, AQ 4XI HART ISOL
General information	
Product type designation	AQ 4xI HART ISOL HA
Engineering with	
• PROFIBUS from GSD version/ GSD revision	Yes / Yes
• PROFINET from GSD version/ GSD revision	Yes / Yes
Supply voltage	
Rated value (DC)	24 V
Reverse polarity protection	Yes
Analog outputs	
Number of analog outputs	4
Output ranges, current	
• 0 to 20 mA	Yes; 15 bit
• 4 mA to 20 mA	Yes; 15 bit
Connection of actuators	
• for current output two-wire connection	Yes

Article number	6DL1135-6UD00-0PK0 ET 200SP HA, AQ 4XI HART ISOL
Load impedance (in rated range of output)	
• with current outputs, max.	750 Ω
• with current outputs, inductive load, max.	10 mH
Cable length	
• shielded, max.	1 000 m; with unshielded cables up to 800 m, remember that (external) EMC loads can cause incorrect measured values
Settling time	
• for resistive load	1.2 ms; 750 ohm
• for inductive load	1.2 ms
Errors/accuracies	
Basic error limit (operational limit at 25 °C)	
• Current, relative to output range, (+/-)	0.1 %
Interrupts/diagnostics/ status information	
Diagnostics function	Yes
Alarms	
• Diagnostic alarm	Yes
Diagnoses	
• Monitoring the supply voltage	Yes
• Wire-break	Yes; channel by channel
• Short-circuit	Yes
• Overflow/underflow	Yes; channel by channel
Diagnostics indication LED	
• MAINT LED	Yes; Yellow LED
• Monitoring of the supply voltage (PWR-LED)	Yes; green PWR LED
• Channel status display	Yes; green LED
• for channel diagnostics	Yes; red LED
• for module diagnostics	Yes; green/red DIAG LED
Potential separation	
Potential separation channels	
• between the channels and backplane bus	Yes; 125 V AC / 150 V DC
Ambient conditions	
Ambient temperature during operation	
• horizontal installation, min.	-40 °C
• horizontal installation, max.	70 °C; Observe derating
• vertical installation, min.	-40 °C
• vertical installation, max.	60 °C; Observe derating
Dimensions	
Width	22.5 mm
Height	115 mm
Depth	138 mm
Weights	
Weight, approx.	165 g

SIMATIC PCS 7 system hardware

Process I/O

SIMATIC ET 200SP HA

Analog/digital module**Overview**

The I/O module AI-DI 16/DQ16x24VDC HART HA is available in the following versions:

- DI 16/DQ16x24VDC HA in digital-only mode
- AI-DI 16/DQ 16x24VDC HART HA as digital/analog module in mixed mode

Time stamping is available with configuration in mixed mode. High-precision time stamping (SoE: Sequence of Events) with a precision of 1 ms is available with configuration in digital-only mode.

In mixed mode, the 16 inputs can also be set channel by channel as either digital inputs or analog inputs with or without HART. HART is only available in mixed mode and with configuration in a measuring range of 4 to 20 mA.

Design

The AI-DI 16/DQ16x24 V DC HART HA analog/digital module has the following technical features:

- 16 inputs configurable as digital or analog inputs
- Digital inputs with the following features configurable per channel:
 - Pulse stretching
 - Time stamping in mixed mode
 - Time stamping with a precision of 1 ms in digital-only mode
 - Hardware interrupts for positive and negative edges
 - Input delay
- Analog inputs with the following features configurable per channel:
 - Current measurement type for 2-wire measuring transducer
 - Measuring ranges 0 to 20 mA, 0 to 10 mA, 4 to 20 mA or 4 to 20 mA with HART
 - Resolution depends on measuring range and interference frequency suppression; minimum of 15 bits, maximum of 16 bits including sign
 - Hardware interrupts for monitoring configurable limits
 - Smoothing
 - Interference frequency suppression 10 Hz, 50 Hz or 60 Hz
 - Configurable wire break limit
- 16 outputs configurable as digital outputs or as sensor supplies for analog current measurement
 - Substitute value configurable per channel for the digital outputs
- Diagnostics configurable per channel
- Diagnostics configurable per module: no supply voltage L+

Ordering data**Article No.****AI-DI 16/DQ16x24VDC HART HA input/output module**

16 channels, each with digital output and digital/analog input

Color code CC01, for terminal block type H1 and M1

6DL1133-6EW00-0PH1**Accessories****Labeling strips**

For labeling the I/O modules

- Roll, light gray (with a total of 500 labeling strips), 1 unit
- DIN A4 sheet, light gray, 10 items per packing unit, 45 labeling strips per sheet (450)
- DIN A4 sheet, yellow, 10 items per packing unit, 45 labeling strips per sheet (450)

6DL1193-6LR00-0AA0**6DL1193-6LA00-0AA0****6DL1193-6LA00-0AG0****Color-coded labels**

For push-in terminals

- Color code CC01, 10 units gray (terminals 1 to 16), red (terminals 17 to 32)

6DL1193-6CP01-2HH1**Equipment labeling plates**

10 sheets with 16 labels each

6ES7193-6LF30-0AW0**Slot cover for I/O modules**

22.5 mm wide

6DL1133-6CV22-0AM0

Technical specifications

Article number	6DL1133-6EW00-0PH1 ET 200SP HA, AI-DI16/DQ16X24VDC HART	Article number	6DL1133-6EW00-0PH1 ET 200SP HA, AI-DI16/DQ16X24VDC HART
General information		Digital outputs	
Product type designation	AI-DI 16/DQ 16x24VDC HART HA	Number of digital outputs	16
Engineering with		Current-sinking	No
• STEP 7 TIA Portal configurable/ integrated from version	V16	Current-sourcing	Yes
• STEP 7 configurable/integrated from version	V5.6	Digital outputs, parameterizable	Yes
• PCS 7 configurable/integrated from version	V9.0	Short-circuit protection	Yes; Response threshold 0.7 A to 1.3 A
• PCS neo can be configured/integrated from version	V3.0	Open-circuit detection	Yes
• PROFINET from GSD version/ GSD revision	GSDML V2.3	Overload protection	Yes
Operating mode		Limitation of inductive shutdown voltage to	L+ (-37 to 41V)
• DI	Yes	Controlling a digital input	Yes
• Counter	Yes	Switching capacity of the outputs	
• DQ	Yes	• with resistive load, max.	0.5 A
• DQ with energy-saving function	No	• on lamp load, max.	5 W
• PWM	No	Load resistance range	
• Oversampling	No	• lower limit	48 Ω
• MSI	No	• upper limit	12 kΩ
• MSO	No	Output current	
Supply voltage		• for signal "1" rated value	0.5 A
Rated value (DC)	24 V	• for signal "0" residual current, max.	0.7 mA
Reverse polarity protection	Yes	Output delay with resistive load	
Encoder supply		• "0" to "1", typ.	50 μs
Number of outputs	16	• "1" to "0", typ.	100 μs
Short-circuit protection	Yes; per channel, electronic	Parallel switching of two outputs	
Digital inputs		• for uprating	No
Number of digital inputs	16	• for redundant control of a load	Yes
Digital inputs, parameterizable	Yes	Switching frequency	
Source/sink input	Yes; P-reading	• with resistive load, max.	100 Hz
Input characteristic curve in accordance with IEC 61131, type 1	Yes	• on lamp load, max.	10 Hz
Input characteristic curve in accordance with IEC 61131, type 2	No	Total current of the outputs	
Input characteristic curve in accordance with IEC 61131, type 3	Yes	• Current per channel, max.	0.5 A
Pulse extension	Yes; off, 50 ms, 100 ms, 200 ms, 500 ms, 1 s, 2 s	• Current per module, max.	2 A
Time stamping	Yes; Resolution 10 ms	Cable length	
Time stamp (with precision of 1 ms)	Yes; Resolution 1ms	• shielded, max.	1 000 m
Digital input functions, parameterizable		• unshielded, max.	600 m
• Gate start/stop	Yes; Partner channel of n+8 counter	Analog inputs	
• Freely usable digital input	Yes; Parameterizable input filter	Number of analog inputs	16
• Counter	Yes; Incl. frequency measurement	permissible input current for current input (destruction limit), max.	30 mA
Input voltage		Input ranges	
• Rated value (DC)	24 V	• Current	Yes; 0 ... 10 mA, 0 ... 20 mA, 4 ... 20 mA, 4 ... 20 mA HART
• for signal "0"	-30 to +5 V	Input ranges (rated values), currents	
• for signal "1"	+11 to +30V	• 0 to 10 mA	Yes
Input current		• 0 to 20 mA	Yes; 16 bit incl. sign
• for signal "1", typ.	2.5 mA	• 4 mA to 20 mA	Yes; 16 bit incl. sign
Input delay (for rated value of input voltage)			
for standard inputs			
- parameterizable	Yes; 0.05 / 0.1 / 0.4 / 0.8 / 1.6 / 3.2 / 12.8 / 20 ms (in each case + delay of 30 to 500 μs, depending on line length)		

SIMATIC PCS 7 system hardware

Process I/O

SIMATIC ET 200SP HA

Analog/digital module

Technical specifications

Article number	6DL1133-6EW00-0PH1 ET 200SP HA, AI-DI16/DQ16X24VDC HART
Analog value generation for the inputs	
Integration and conversion time/resolution per channel	
<ul style="list-style-type: none"> Resolution with overrange (bit including sign), max. 	16 bit; Resolution with overrange (bit including sign), max. 16 bits, exception: 15 bits at 60 Hz interference suppression and 0 to 10 mA
<ul style="list-style-type: none"> Integration time, parameterizable 	Yes; channel by channel
Smoothing of measured values	
<ul style="list-style-type: none"> parameterizable 	Yes; none, weak, medium, strong, channel-by-channel
Encoder	
Connection of signal encoders	
<ul style="list-style-type: none"> for current measurement as 2-wire transducer 	Yes
Connectable encoders	
<ul style="list-style-type: none"> 2-wire sensor - permissible quiescent current (2-wire sensor), max. 	Yes 1.5 mA
Errors/accuracies	
Basic error limit (operational limit at 25 °C)	
<ul style="list-style-type: none"> Current, relative to input range, (+/-) 	0.1 %
Interrupts/diagnostics/status information	
Diagnostics function	Yes
Substitute values connectable	Yes
Alarms	
<ul style="list-style-type: none"> Diagnostic alarm Maintenance interrupt Limit value alarm Hardware interrupt 	Yes Yes Yes; two upper and two lower limit values in each case Yes; Parameterizable, channels 0 to 15, rising/falling edge
Diagnoses	
<ul style="list-style-type: none"> Monitoring the supply voltage Wire-break Short-circuit to M Group error Overflow/underflow 	Yes Yes; channel by channel Yes; Encoder supply to M, channel by channel Yes Yes; channel by channel
Diagnostics indication LED	
<ul style="list-style-type: none"> MAINT LED Monitoring of the supply voltage (PWR-LED) Channel status display for channel diagnostics for module diagnostics 	Yes; Yellow LED Yes; green PWR LED No No Yes; green/red DIAG LED

Article number	6DL1133-6EW00-0PH1 ET 200SP HA, AI-DI16/DQ16X24VDC HART
Integrated functions	
Frequency measurement	Yes
<ul style="list-style-type: none"> Number of frequency meters 	8
Counting functions	
<ul style="list-style-type: none"> Continuous counting Counter response parameterizable Hardware gate via digital input Software gate 	Yes Yes Yes; Via partner channel (digital input n+8) Yes
Measuring functions	
<ul style="list-style-type: none"> Dynamic measurement period adjustment 	Yes
Measuring range	
<ul style="list-style-type: none"> Frequency measurement, min. Frequency measurement, max. 	0.1 Hz 5 kHz
Accuracy	
<ul style="list-style-type: none"> Frequency measurement 	100 ppm; depending on measuring interval and signal evaluation
Potential separation	
Potential separation channels	
<ul style="list-style-type: none"> between the channels and backplane bus 	Yes
Ambient conditions	
Ambient temperature during operation	
<ul style="list-style-type: none"> horizontal installation, min. horizontal installation, max. vertical installation, min. vertical installation, max. 	-40 °C 70 °C; Observe derating -40 °C 60 °C; Observe derating
Dimensions	
Width	22.5 mm
Height	115 mm
Depth	138 mm
Weights	
Weight, approx.	150 g

Overview

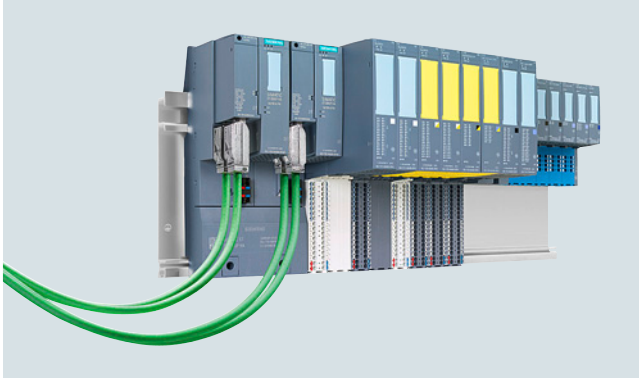

Fail-safe I/O modules permit safety-oriented monitoring and thus, when required, bringing the plant to the defined safe state. The communication and integration into the process control system is enabled with the proven technology SIMATIC Safety Integrated. The fail-safe I/O modules for DI, DQ and AI correspond to the size of the standard modules and are certified by the German Technical Inspectorate up to SIL 3 per channel. All fail-safe modules can be set up in redundant design guaranteeing not only fail-safe operation but also highest availability. SIMATIC ET 200SP HA is perfectly adapted for demanding fail-safe and standard applications in the manufacturing and process industries when high availability and PROFINET R1 redundancy are imperative.

- <https://www.siemens.com/process-safety>

Ordering data

Article No.

F-DI 16x24VDC HA digital input module

16 24 V DC digital inputs, color code CC01, for terminal block type H1 and M1, channel diagnostics

6DL1136-6BA00-0PH1

F-DQ 10x24VDC/2A HA digital output module

10 digital outputs 24 V DC, 2 A, color code CC01, for terminal block type H1 and M1, channel diagnostics

6DL1136-6DA00-0PH1

F-AI 8x1 2-/4-wire HART HA analog input module

8 digital inputs, color code CC00, for terminal block type H1 and F1, channel diagnostics

6DL1136-6AA00-0PH1

SIMATIC PCS 7 system hardware

Process I/O

SIMATIC ET 200SP HA

Ex I/O modules

Overview



The intrinsically safe ET 200SP HA Ex I/O modules extend the SIMATIC ET 200SP HA and SIMATIC ET 200SP distributed I/O systems with the option of integrating devices located in hazardous areas (intrinsically safe sensors, actuators and HART field devices) into the system.

The ET 200SP HA Ex I/O modules with device protection according to intrinsic safety "i" offer channel outputs in Zone 0 or 1. 2-channel HART analog input and output modules and 2/4-channel digital input and output modules with different characteristic curves as well as a power module for intrinsically safe power supply of the modules.

Separate Ex isolators with correspondingly complex wiring and high space requirements are no longer required. The I/O modules can be installed up to ATEX Zone 2 and offer intrinsically safe circuits in Ex ia design for field devices up to Zone 0.

The Ex modules offer channel diagnostics and configuration in Run and are approved for ambient temperatures from -40 to +70 °C.

Design

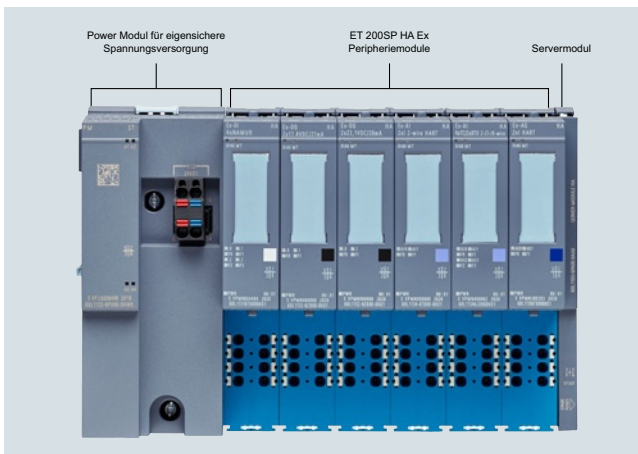

Digital Ex I/O modules



- Digital input module Ex-DI 4xNAMUR
4 NAMUR digital inputs
- Digital output module Ex-DQ 2x17.4VDC/27 mA
2 digital outputs DC 17.4 V / 27 mA
- Digital output module Ex-DQ 2x23.1VDC/20 mA
2 digital outputs DC 23.1 V / 20 mA

Analog Ex I/O modules



- Analog input module Ex-AI 2xI 2-wire HART
2 analog inputs
Measuring range 0 to 20 mA, 4 to 20 mA, 4 to 20 mA with HART
- Analog output module Ex-AQ 2xI HART
2 analog outputs
Measuring range 0 to 20 mA, 4 to 20 mA, 4 to 20 mA with HART
- Analog input module Ex-AI 4xTC/2xRTD 2-/3-/4-wire
2/4 analog inputs
Measuring ranges:
 - Voltage
 - TC (thermocouples) Type B, C, E, J, K, L, N, R, S, T, U, TXK & TXK (L)
 - RTD (resistance temperature sensors)
 - Resistor
- Analog output module Ex-AQ 2xI HART
2 analog outputs
Measuring range 0 to 20 mA, 4 to 20 mA, 4 to 20 mA with HART

Design (continued)

Power module Ex-PM-E



- Power supply module Ex-PM-E
24 V DC for intrinsically safe supply of the following Ex-ia I/O modules (Power Bus)
Horizontal / vertical installation
 - Up to 60 °C / 50 °C: 0.8 A
 - Up to 70 °C / 60 °C: 0.6 A

Terminal blocks



- BaseUnit Type W0 for power module Ex-PM-E
- BaseUnit Type X1 for Ex electronics modules

Ordering data

Article No.

Article No.

Ex digital modules
SIMATIC ET 200SP HADigital Ex-i input module,
Ex-DI 4xNAMUR

Suitable for BaseUnit Type X1,
channel diagnostics

6DL1131-6TD00-0HX1

Digital Ex-i output module
Ex-DQ 2x23,1VDC/20 mA

Suitable for BaseUnit Type X1,
channel diagnostics

6DL1132-6EB00-0HX1

Digital Ex-i output module
Ex-DQ 2x17,4VDC/27 mA

Suitable for BaseUnit Type X1,
channel diagnostics

6DL1132-6CB00-0HX1

Ex analog modules
SIMATIC ET 200SP HAAnalog Ex-i HART input module,
Ex-AI 2xI 2-wire HART

Suitable for BaseUnit Type X1,
channel diagnostics, 16 bits,
+/-0.3%

6DL1134-6TB00-0HX1

Analog Ex-i input module,
Ex-AI 4xTC/2xRTD 2-/3-/4-wire

Suitable for BaseUnit Type X1,
channel diagnostics, 16 bits,
+/-0.05%

6DL1134-6JD00-0HX1

Analog Ex-i HART output module,
Ex-AQ 2xI HART HF

Suitable for BaseUnit Type X1,
channel diagnostics, 16 bits,
+/-0.3%

6DL1135-6TB00-0HX1

Power module and BaseUnits

Power module Ex-PM E

24 V 0.8 A, W x H: 50 mm x
117 mm, suitable for
BaseUnit Type W0

6DL1133-6PX00-0HW0

BU Type X1 for I/O modules

Push-in terminals, W x H:
20 mm x 117 mm

6DL1193-6BP00-0BX1

BU Type W0 for Ex
power module PM-E

W x H: 50 mm x 117 mm

6DL1193-6BP00-0DW0

SIMATIC PCS 7 system hardware

Process I/O

SIMATIC ET 200SP HA

Ex I/O modules

Technical specifications

Article number	6DL1131-6TD00-0HX1 ET 200SP HA, EX-DI 4xNAMUR
General information	
Product type designation	Ex-DI 4xNAMUR
Product function	
• Isochronous mode	No
Engineering with	
• STEP 7 TIA Portal configurable/integrated from version	STEP 7 V17 or higher
• STEP 7 configurable/integrated from version	STEP 7 V5.6 SP2 or higher
• PCS 7 configurable/integrated from version	V9.1
Operating mode	
• DI	Yes
• Counter	Yes
• MSI	Yes
Encoder supply	
Number of outputs	4
Short-circuit protection	Yes
Digital inputs	
Number of digital inputs	4; NAMUR
Digital inputs, parameterizable	Yes
Pulse extension	Yes; 0.5 s, 1 s, 2 s
Time stamping	No
Edge evaluation	Yes; Positive edge, negative edge
Signal change flutter	Yes; 2 to 32 signal changes
Flutter observation window	Yes; 0.5 s, 1 s to 100 s in 1-s steps
Input voltage	
• Rated value (DC)	8.2 V
Input current	
for 10 k switched contact	
- for signal *0*	Max. 1.2 mA
- for signal *1*	Min. 2.1 mA
for unswitched contact	
- for signal *0*, max. (permissible quiescent current)	0.5 mA
- for signal *1*	typ. 8 mA
for NAMUR encoders	
- for signal *0*	0.35 to 1.2 mA
- for signal *1*	2.1 ... 6.4 mA
Encoder	
Connectable encoders	
• NAMUR encoder/changeover contact according to EN 60947	Yes
• Single contact / changeover contact unconnected	Yes
• Single contact / changeover contact connected with 10 k Ω	Yes

Article number	6DL1131-6TD00-0HX1 ET 200SP HA, EX-DI 4xNAMUR
Interrupts/diagnostics/status information	
Diagnostics function	Yes
Alarms	
• Diagnostic alarm	Yes
• Maintenance interrupt	Yes
• Hardware interrupt	Yes; channel by channel
Diagnoses	
• Diagnostic information readable	Yes
• Monitoring the supply voltage	Yes
- parameterizable	Yes
• Monitoring of encoder power supply	Yes
• Wire-break	Yes; channel by channel
• Short-circuit	Yes; channel by channel
• Group error	Yes
Diagnostics indication LED	
• MAINT LED	Yes; Yellow LED
• Monitoring of the supply voltage (PWR-LED)	Yes; green PWR LED
• Channel status display	Yes; green LED
• for channel diagnostics	Yes; red LED
• for module diagnostics	Yes; green/red DIAG LED
Potential separation	
Potential separation channels	
• between the channels and backplane bus	Yes
Ambient conditions	
Ambient temperature during operation	
• horizontal installation, min.	-40 °C
• horizontal installation, max.	70 °C
• vertical installation, min.	-40 °C
• vertical installation, max.	60 °C
Altitude during operation relating to sea level	
• Installation altitude above sea level, max.	2 000 m
Dimensions	
Width	20 mm
Height	73 mm
Depth	58 mm
Weights	
Weight, approx.	55 g

Technical specifications (continued)

Article number	6DL1132-6EB00-0HX1 ET 200SP HA, EX-DQ 2x23, 1VDC/20MA	6DL1132-6CB00-0HX1 ET 200SP HA, EX-DQ 2x17, 4VDC/27MA
General information		
Product function		
• Isochronous mode	No	No
Engineering with		
• STEP 7 TIA Portal configurable/ integrated from version	STEP 7 V17 or higher	STEP 7 V17 or higher
• STEP 7 configurable/integrated from version	STEP 7 V5.6 SP2 or higher	STEP 7 V5.6 SP2 or higher
• PCS 7 configurable/integrated from version	V9.1	V9.1
Operating mode		
• DQ	Yes	Yes
• MSO	Yes	Yes
Digital outputs		
Number of digital outputs	2	2
Current-sinking	No	No
Current-sourcing	Yes	Yes
Digital outputs, parameterizable	Yes	Yes
Short-circuit protection	Yes	Yes
Open-circuit detection	Yes; capacitive loads can cause wire-break diagnostics when the channel is switched off	Yes; capacitive loads can cause wire-break diagnostics when the channel is switched off
Overload protection	Yes	Yes
Limitation of inductive shutdown voltage to	DQ.n- (-1 V)	DQ.n- (-1 V)
Switching capacity of the outputs		
• with resistive load, max.	20 mA; See output characteristic in manual	27 mA; See output characteristic in manual
• with inductive load, max.	20 mA; See output characteristic in manual	27 mA; See output characteristic in manual
Load resistance range		
• lower limit	872 Ω; See output characteristic in manual	480 Ω; parallel operation 240 ohm, see output characteristic in manual
• upper limit	10 kΩ; See output characteristic in manual	10 kΩ; parallel operation 5 kOhm, see output characteristic in manual
Output current		
• for signal "1" rated value	20 mA	27 mA
• for signal "0" residual current, max.	100 μA; 250 μA test current for wire break diagnostics	100 μA; 250 μA test current for wire break diagnostics, parallel operation 500 μA
Output delay with resistive load		
• "0" to "1", typ.	50 μs	50 μs
• "1" to "0", typ.	100 μs	100 μs
Parallel switching of two outputs		
• for uprating	No	Yes
Switching frequency		
• with resistive load, max.	500 Hz	500 Hz
• with inductive load, max.	500 Hz	500 Hz
Total current of the outputs		
• Current per channel, max.	20 mA	27 mA
• Current per module, max.	40 mA	54 mA
Total current of the outputs (per module)		
horizontal installation		
- up to 70 °C, max.	40 mA	54 mA
vertical installation		
- up to 60 °C, max.	40 mA	54 mA
Cable length		
• shielded, max.	500 m; Ex characteristic values must be observed	500 m; Ex characteristic values must be observed
• unshielded, max.	500 m; Ex characteristic values must be observed	500 m; Ex characteristic values must be observed

SIMATIC PCS 7 system hardware

Process I/O

SIMATIC ET 200SP HA

Ex I/O modules**Technical specifications** (continued)

Article number	6DL1132-6EB00-0HX1 ET 200SP HA, EX-DQ 2x23, 1VDC/20MA	6DL1132-6CB00-0HX1 ET 200SP HA, EX-DQ 2x17, 4VDC/27MA
Interrupts/diagnostics/ status information		
Diagnostics function	Yes	Yes
Substitute values connectable	Yes	Yes
Alarms		
• Diagnostic alarm	Yes	Yes
• Maintenance interrupt	Yes	Yes
Diagnoses		
• Diagnostic information readable	Yes	Yes
• Monitoring the supply voltage	Yes	Yes
- parameterizable	Yes	Yes
• Wire-break	Yes; channel by channel	Yes; channel by channel
• Short-circuit	Yes; channel by channel	Yes; channel by channel
• Group error	Yes	Yes
Diagnostics indication LED		
• MAINT LED	Yes; Yellow LED	Yes; Yellow LED
• Monitoring of the supply voltage (PWR-LED)	Yes; green PWR LED	Yes; green PWR LED
• Channel status display	Yes; green LED	Yes; green LED
• for channel diagnostics	Yes; red LED	Yes; red LED
• for module diagnostics	Yes; green/red DIAG LED	Yes; green/red DIAG LED
Potential separation		
Potential separation channels		
• between the channels and backplane bus	Yes	Yes
Ambient conditions		
Ambient temperature during operation		
• horizontal installation, min.	-40 °C	-40 °C
• horizontal installation, max.	70 °C	70 °C
• vertical installation, min.	-40 °C	-40 °C
• vertical installation, max.	60 °C	60 °C
Altitude during operation relating to sea level		
• Installation altitude above sea level, max.	2 000 m	2 000 m
Dimensions		
Width	20 mm	20 mm
Height	73 mm	73 mm
Depth	58 mm	58 mm
Weights		
Weight, approx.	55 g	55 g

Technical specifications (continued)

Article number	6DL1134-6TB00-0HX1	6DL1134-6JD00-0HX1
	ET 200SP HA, EX-AI 2xI 2-WIRE HART	ET 200SP HA, EX-AI 4xTC/2xRTD 2-/3-/4-W
General information		
Product type designation	Ex-AI 2xI 2-wire HART	Ex-AI 4xTC/2xRTD 2-/3-/4-wire
Product function		
• I&M data	Yes; I&M0 to I&M3	Yes; I&M0 to I&M3
• Isochronous mode	No	No
Engineering with		
• STEP 7 TIA Portal configurable/integrated from version	STEP 7 V17 or higher	STEP 7 V17 or higher
• STEP 7 configurable/integrated from version	STEP 7 V5.6 SP2 or higher	STEP 7 V5.6 SP2 or higher
• PCS 7 configurable/integrated from version	V9.1	V9.1
Operating mode		
• MSI	Yes	Yes
Analog inputs		
Number of analog inputs	2; Differential inputs	
• For current measurement	2	
• For voltage measurement		4
• For resistance/resistance thermometer measurement		2
• For thermocouple measurement		4
Constant measurement current for resistance-type transmitter, typ.		0.5 mA
Cycle time (all channels), min.	3 ms	
Technical unit for temperature measurement adjustable		Yes; °C/°F/K
Input ranges (rated values), voltages		
• -1 V to +1 V		Yes; 16 bit incl. sign
• -250 mV to +250 mV		Yes; 16 bit incl. sign
• -50 mV to +50 mV		Yes; 16 bit incl. sign
• -80 mV to +80 mV		Yes; 16 bit incl. sign
Input ranges (rated values), currents		
• 0 to 20 mA	Yes	
• 4 mA to 20 mA	Yes; 15 bit + sign	
Input ranges (rated values), thermocouples		
• Type B		Yes; 16 bit incl. sign
• Type C		Yes; 16 bit incl. sign
• Type E		Yes; 16 bit incl. sign
• Type J		Yes; 16 bit incl. sign
• Type K		Yes; 16 bit incl. sign
• Type L		Yes; 16 bit incl. sign
• Type N		Yes; 16 bit incl. sign
• Type R		Yes; 16 bit incl. sign
• Type S		Yes; 16 bit incl. sign
• Type T		Yes; 16 bit incl. sign
• Type U		Yes; 16 bit incl. sign
• Type TXK/TXK(L) to GOST		Yes; 16 bit incl. sign

SIMATIC PCS 7 system hardware

Process I/O

SIMATIC ET 200SP HA

Ex I/O modules**Technical specifications** (continued)

Article number	6DL1134-6TB00-0HX1 ET 200SP HA, EX-AI 2xI 2-WIRE HART	6DL1134-6JD00-0HX1 ET 200SP HA, EX-AI 4xTC/2xRTD 2-/3-/4-W
Input ranges (rated values), resistance thermometer		
<ul style="list-style-type: none"> • Cu 10 • Ni 100 • LG-Ni 1000 • Ni 120 • Ni 200 • Ni 500 • Pt 100 • Pt 1000 • Pt 200 • Pt 500 		<ul style="list-style-type: none"> Yes; 16 bit incl. sign Yes; 16 bit incl. sign Yes; 16 bit incl. sign Yes; 16 bit incl. sign Yes; 16 bit incl. sign Yes; 16 bit incl. sign Yes; 16 bit incl. sign Yes; 16 bit incl. sign Yes; 16 bit incl. sign Yes; 16 bit incl. sign
Input ranges (rated values), resistors		
<ul style="list-style-type: none"> • 0 to 150 ohms • 0 to 300 ohms • 0 to 600 ohms • 0 to 3000 ohms • 0 to 6000 ohms • PTC 		<ul style="list-style-type: none"> Yes; 15 bit Yes; 15 bit Yes; 15 bit Yes; 15 bit Yes; 15 bit Yes; 15 bit
Thermocouple (TC)		
Temperature compensation - parameterizable		Yes
Cable length		
<ul style="list-style-type: none"> • shielded, max. 	500 m; Ex characteristic values must be observed	200 m; Ex characteristic values must be observed; line resistance at RTD (simple) max. 25 ohm; loop resistance at TC max. 8 kOhm
Analog value generation for the inputs		
Measurement principle	integrating (Sigma-Delta)	integrating (Sigma-Delta)
Integration and conversion time/resolution per channel		
<ul style="list-style-type: none"> • Resolution with overrange (bit including sign), max. • Integration time, parameterizable • Interference voltage suppression for interference frequency f1 in Hz • Conversion time (per channel) 	<ul style="list-style-type: none"> 16 bit Yes; channel by channel 10 / 50 / 60 Hz 	<ul style="list-style-type: none"> 16 bit Yes; Channel-by-channel, results from the selected interference frequency suppression 16.6 / 50 / 60 Hz, channel-by-channel 180 / 60 / 50 ms, results from the selected interference frequency suppression
Smoothing of measured values		
<ul style="list-style-type: none"> • Number of smoothing levels • parameterizable 	<ul style="list-style-type: none"> 4; None; 4/8/16 times Yes 	<ul style="list-style-type: none"> Yes; none, weak, medium, strong, channel-by-channel
Encoder		
Connection of signal encoders		
<ul style="list-style-type: none"> • for current measurement as 2-wire transducer - Burden of 2-wire transmitter, max. 	<ul style="list-style-type: none"> Yes 750 Ω; At 20 mA input current 	
Errors/accuracies		
Basic error limit (operational limit at 25 °C)		
<ul style="list-style-type: none"> • Voltage, relative to input range, (+/-) • Current, relative to input range, (+/-) • Resistance, relative to input range, (+/-) 	<ul style="list-style-type: none"> 0.2 % 	<ul style="list-style-type: none"> 0.05 % 0.05 %

Technical specifications (continued)

Article number	6DL1134-6TB00-0HX1 ET 200SP HA, EX-AI 2xI 2-WIRE HART	6DL1134-6JD00-0HX1 ET 200SP HA, EX-AI 4xTC/2xRTD 2-/3-/4-W
Interference voltage suppression for $f = n \times (f1 \pm 1 \%)$, f1 = interference frequency		
<ul style="list-style-type: none"> Series mode interference (peak value of interference < rated value of input range), min. Common mode voltage, max. Common mode interference, min. 	60 dB	70 dB 60 V; Applicable for use in non-hazardous areas; no common mode voltage permissible in hazardous areas 90 dB
Interrupts/diagnostics/ status information		
Diagnostics function	Yes	Yes
Alarms		
<ul style="list-style-type: none"> Diagnostic alarm Limit value alarm 	Yes Yes	Yes Yes; two upper and two lower limit values in each case
Diagnoses		
<ul style="list-style-type: none"> Monitoring the supply voltage Wire-break Short-circuit Group error Overflow/underflow 	Yes Yes; channel by channel Yes; channel by channel Yes Yes; channel by channel	Yes Yes; channel by channel Yes; channel by channel
Diagnostics indication LED		
<ul style="list-style-type: none"> MAINT LED Monitoring of the supply voltage (PWR-LED) Channel status display for channel diagnostics for module diagnostics 	Yes; Yellow LED Yes; green PWR LED Yes; green LED Yes; red LED Yes; green/red DIAG LED	Yes; Yellow LED Yes; green PWR LED Yes; green LED Yes; red LED Yes; green/red DIAG LED
Potential separation		
Potential separation channels		
<ul style="list-style-type: none"> between the channels and backplane bus 	Yes	Yes
Ambient conditions		
Ambient temperature during operation		
<ul style="list-style-type: none"> horizontal installation, min. horizontal installation, max. vertical installation, min. vertical installation, max. 	-40 °C 70 °C -40 °C 60 °C	-40 °C 70 °C -40 °C 60 °C
Altitude during operation relating to sea level		
<ul style="list-style-type: none"> Installation altitude above sea level, max. 	2 000 m	2 000 m
Dimensions		
Width	20 mm	20 mm
Height	73 mm	73 mm
Depth	58 mm	58 mm
Weights		
Weight, approx.	55 g	55 g

SIMATIC PCS 7 system hardware

Process I/O

SIMATIC ET 200SP HA

Ex I/O modules

Technical specifications (continued)

Article number	6DL1135-6TB00-0HX1 ET 200SP HA, EX-AQ 2xI HART
General information	
Product type designation	Ex-AQ 2xI HART
Product function	
• I&M data	Yes; I&M0 to I&M3
• Isochronous mode	No
Engineering with	
• STEP 7 TIA Portal configurable/integrated from version	STEP 7 V17 or higher
• STEP 7 configurable/integrated from version	STEP 7 V5.6 SP2 or higher
• PCS 7 configurable/integrated from version	V9.1
Operating mode	
• MSO	Yes
Analog outputs	
Number of analog outputs	2
Cycle time (all channels), min.	3 ms
Output ranges, current	
• 0 to 20 mA	Yes; 15 bit
• 4 mA to 20 mA	Yes; 16 bit incl. sign
Connection of actuators	
• for current output two-wire connection	Yes
Load impedance (in rated range of output)	
• with current outputs, max.	500 Ω
• with current outputs, inductive load, max.	Ex characteristic values must be observed
Cable length	
• shielded, max.	500 m; Ex characteristic values must be observed
Settling time	
• for resistive load	1 ms; 500 ohms
Errors/accuracies	
Basic error limit (operational limit at 25 °C)	
• Current, relative to output range, (+/-)	0.2 %
Protocols	
HART protocol	Yes
Interrupts/diagnostics/status information	
Diagnostics function	Yes
Substitute values connectable	Yes
Alarms	
• Diagnostic alarm	Yes

Article number	6DL1135-6TB00-0HX1 ET 200SP HA, EX-AQ 2xI HART
Diagnoses	
• Monitoring the supply voltage	Yes; Module-wise
• Wire-break	Yes; From output value > 240 μA
• Short-circuit	Yes; < 20 ohms as of 1 mA output value
• Group error	Yes
• Overflow/underflow	Yes; channel by channel
Diagnostics indication LED	
• MAINT LED	Yes; Yellow LED
• Monitoring of the supply voltage (PWR-LED)	Yes; green PWR LED
• Channel status display	Yes; green LED
• for channel diagnostics	Yes; red LED
• for module diagnostics	Yes; green/red DIAG LED
Potential separation	
Potential separation channels	
• between the channels and backplane bus	Yes
Ambient conditions	
Ambient temperature during operation	
• horizontal installation, min.	-40 °C
• horizontal installation, max.	70 °C
• vertical installation, min.	-40 °C
• vertical installation, max.	60 °C
Altitude during operation relating to sea level	
• Installation altitude above sea level, max.	2 000 m
Dimensions	
Width	20 mm
Height	73 mm
Depth	58 mm
Weights	
Weight, approx.	55 g

Technical specifications (continued)

Article number	6DL1133-6PX00-0HWO ET 200SP HA, Ex-PM E power module	Article number	6DL1133-6PX00-0HWO ET 200SP HA, Ex-PM E power module
General information		Diagnostics indication LED	
Product type designation	Ex-PM E	• MAINT-LED	Yes; Yellow LED
Product function		• Monitoring of the supply voltage (PWR-LED)	Yes; green PWR LED
• I&M data	Yes; Asset data	• for module diagnostics	Yes; green/red DIAG LED
Supply voltage		Ex(i) characteristics	
Rated value (DC)	24 V	Module for Ex(i) protection	Yes
Reverse polarity protection	Yes	maximum values for connecting terminals for gas group IIC	
Output current		• Um (voltage at non-intrinsically safe connecting terminals), max	60 V; power supply and backplane bus
horizontal installation		Potential separation	
• up to 60 °C, max.	0.8 A	primary/secondary	Yes
• up to 70 °C, max.	0.6 A	Ambient conditions	
vertical installation		Ambient temperature during operation	
• up to 50 °C, max.	0.8 A	• min.	-40 °C
• up to 60 °C, max.	0.6 A	• max.	70 °C; with derating
Interrupts/diagnostics/status information		Altitude during operation relating to sea level	
Diagnostics function	Yes	• Installation altitude above sea level, max.	2 000 m
Diagnoses		Dimensions	
• Diagnostic information readable	Yes	Width	50 mm
• missing load voltage	Yes	Height	114 mm
		Depth	67.5 mm
		Weights	
		Weight, approx.	182 g
Article number	6DL1193-6BP00-0DWO ET 200SP HA, Ex-BU TYPE W0	6DL1193-6BP00-0BX1 ET 200SP HA, Ex-BU TYPE X1	
General information		General information	
Product type designation	BU type W0	Product type designation	BU type X1
Product function		Product function	
• I&M data	Yes; Asset data	• I&M data	Yes; Asset data
Hardware configuration		Hardware configuration	
Slots		Slots	
• Number of slots	1	• Number of slots	1
Ambient conditions		Ambient conditions	
Ambient temperature during operation		Ambient temperature during operation	
• horizontal installation, min.	-40 °C	• horizontal installation, min.	-40 °C
• horizontal installation, max.	70 °C	• horizontal installation, max.	70 °C
• vertical installation, min.	-40 °C	• vertical installation, min.	-40 °C
• vertical installation, max.	60 °C	• vertical installation, max.	60 °C
Altitude during operation relating to sea level		Altitude during operation relating to sea level	
• Installation altitude above sea level, max.	2 000 m	• Installation altitude above sea level, max.	2 000 m
Connection method		Connection method	
Terminals		Terminals	
• Terminal type		• Terminal type	Push-in terminal
• Conductor cross-section, min.		• Conductor cross-section, min.	0.14 mm ²
• Conductor cross-section, max.		• Conductor cross-section, max.	2.5 mm ²
• Number of process terminals to I/O module		• Number of process terminals to I/O module	8
Dimensions		Dimensions	
Width	50 mm	Width	20 mm
Height	117 mm	Height	117 mm
Depth	19 mm	Depth	35 mm
Weights		Weights	
Weight, approx.	38 g	Weight, approx.	42 g

SIMATIC PCS 7 system hardware

Process I/O

SIMATIC ET 200SP HA

Carrier modules

Overview

Mounting rails

The mounting rail is required for fitting an ET 200SP HA station in the control cabinet. The IM carrier modules for interface modules, the carrier modules for the I/O modules and the server module are attached to the mounting rail.

The mounting rails are available in lengths of 482 mm (for installation in a 19-inch rack) and 1 500 mm (for maximum configuration and vertical installation in a cabinet).



IM single carrier module



IM redundant carrier module

IM carrier modules for interface modules

Two versions of the IM carrier modules for interface modules are available:

- IM single carrier module for 1 interface module, for single connection to PROFINET
- IM redundant carrier module for 2 interface modules, for redundant connection to PROFINET

The IM carrier modules connect the interface module to the backplane bus. They enable data exchange with the I/O modules.



Carrier module for I/O modules, 8-slot



Carrier module for I/O modules, 2-slot

Carrier modules for I/O modules

The slots for the I/O modules are created by the connection of these carrier modules to the terminal blocks.

Carrier modules for I/O modules are available in the following versions:

- Carrier module, 2-slot, with 2 slots for I/O modules
- Carrier module, 8-slot, with 8 slots for I/O modules
- Carrier module, 8-slot, with 8 slots for I/O modules, without Power Bus function

Overview (continued)

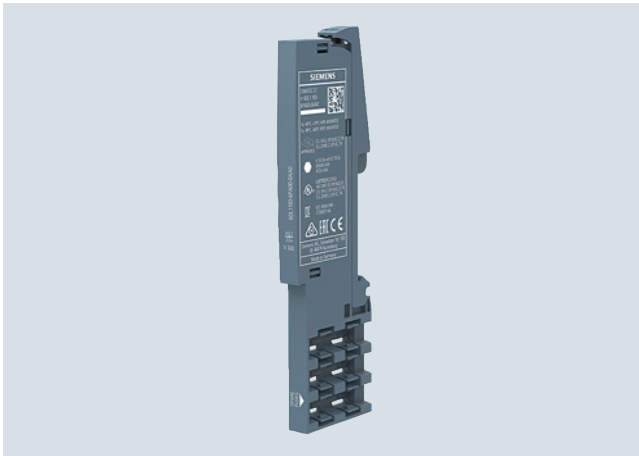

ET 200SP HA, server module

Server module

Server module and power bus cover complete the design of the ET 200SP HA. A server module and a power bus cover are supplied with each IM carrier module for the interface module.

Ordering data	Article No.	Ordering data	Article No.
Mounting rails for ET 200SP HA		Carrier modules for I/O modules	
482 mm (approx. 19 inch) mounting rail Including grounding screw and integrated top hat rail for fitting small components such as clamps, fuses and relays	6DL1193-6MC00-0AA0	Carrier module, 2-slot Rack for 2 SIMATIC ET 200SP HA I/O modules	6DL1193-6GA00-0NN0
1 500 mm (approx. 59 inch) mounting rail Including grounding screw and integrated top hat rail for fitting small components such as clamps, fuses and relays	6DL1193-6MD00-0AA0	Carrier module 8-slot Rack for 8 SIMATIC ET 200SP HA I/O modules	6DL1193-6GC00-0NN0
Grounding screw For connecting PE to the mounting rail; essential for 1 500 mm mounting rail 20 units per packing unit	6ES7590-5AA00-0AA0	Carrier module 8-slot carrier without Power Bus function, can only be operated with light-gray or black terminal blocks, for holding 8 I/O modules of the ET 200SP HA	6DL1193-6GC00-8NN0
IM carrier modules for interface modules Note: A server module and a power bus cover are supplied with each IM carrier module for the interface module.		Spare parts	
IM single carrier module Rack for 1 SIMATIC ET 200SP HA interface module for single connection to PROFINET	6DL1193-6BH00-0SM0	Server module (spare part) for ET 200SP HA	6DL1193-6PA00-0AA0
IM redundant carrier module Rack for 2 SIMATIC ET 200SP HA interface modules for redundant connection to PROFINET	6DL1193-6BH00-0RM0		

SIMATIC PCS 7 system hardware

Process I/O

SIMATIC ET 200SP HA

Carrier modules

Technical specifications

Article number	6DL1193-6BH00-0SM0 CARRIER MODULE IM SINGLE	6DL1193-6BH00-0RM0 CARRIER MODULE IM REDUNDANT
General information		
Product type designation	IM carrier module, single	Carrier module IM redundant
Product function		
• I&M data	Yes; Asset data	Yes; Asset data
Hardware configuration		
Slots		
• Number of slots	1	2
Ambient conditions		
Ambient temperature during operation		
• horizontal installation, min.	-40 °C	-40 °C
• horizontal installation, max.	70 °C	70 °C
• vertical installation, min.	-40 °C	-40 °C
• vertical installation, max.	60 °C	60 °C
Dimensions		
Width	100 mm	100 mm
Height	204 mm	204 mm
Depth	52 mm	52 mm
Weights		
Weight, approx.	250 g	224 g

Article number	6DL1193-6GA00-0NNO CARRIER MODULE TWOFOLD	6DL1193-6GC00-0NNO CARRIER MODULE EIGHTFOLD	6DL1193-6GC00-8NNO CARRIER MODULE EIGHTFOLD w/o PB
General information			
Product type designation	Carrier module 2 times	Carrier module 8 times	carrier module 8x without power bus
Product function			
• I&M data	Yes; Asset data	Yes; Asset data	Yes; Asset data
Hardware configuration			
Slots			
• Number of slots	2	8	8; for light gray and black terminal blocks
Ambient conditions			
Ambient temperature during operation			
• horizontal installation, min.	-40 °C	-40 °C	-40 °C
• horizontal installation, max.	70 °C	70 °C	70 °C
• vertical installation, min.	-40 °C	-40 °C	-40 °C
• vertical installation, max.	60 °C	60 °C	60 °C
Dimensions			
Width	52.5 mm; 45 mm when installed	187.5 mm; 180 mm when installed	187.5 mm; 180 mm when installed
Height	203 mm	203 mm	203 mm
Depth	79 mm	79 mm	79 mm
Weights			
Weight, approx.	111 g	450 g	270 g

Overview







The slots for the I/O modules are created by connecting carrier modules and terminal blocks. The terminal blocks contain the process terminals for connecting sensors, actuators and other devices.

Select the terminal block for the slot of an I/O module based on the following dependencies:

- Definition of I/O modules associated with a potential group
- Requirement for design with redundant I/O modules (redundant partner in adjacent slot)
- Requirement for design with potential distributors (e.g. when using 32-channel I/O modules)

The following table illustrates the terminal block / I/O module assignment (x = standard):

I/O modules in 24 V range

I/O module	TB type H1	TB type H0 (D-sub)	TB type M1 (IO-RED)	TB type F1 (F-AI IO-RED)	TB type P0 (32x L+)	TB type N0 (32x M)
DI 16x24V	x	x	x			x ^{c)}
DI 32x24V	x ^{a)}	x ^{a)}			x	
DI 16xNAMUR	x	x	x			x ^{c)}
DQ 16x24V / 0.5A	x	x	x			x ^{c)}
DQ 32x24V / 0.5A	x ^{b)}	x ^{b)}				x
DI-AI 16x / DQ 16x HART	x	x	x			x ^{c)}
AI 16xI HART	x	x	x			x ^{c)}
AI 16xTC 8xRTD	x	x ^{d)}	x			
AQ 8xI HART	x	x	x			x ^{c)}
F-DI 16x24V	x		x			
F-DQ 10x24V / 2A	x		x	x		
						
Powerbus infeed	Light gray		Light gray		Light gray	Light gray
Powerbus continuer	Dark gray		Dark gray		Dark gray	Dark gray
No powerbus		Black		Black		

a) Encoder supply must be realized separately

b) Ground points must be realized separately

c) Offers 32 additional ground points for field connection

d) No temperature compensation for TC

SIMATIC PCS 7 system hardware

Process I/O

SIMATIC ET 200SP HA

Terminal blocks**Overview (continued)****I/O modules with voltages >24V****I/O modules with channel-selective isolation**

I/O module	TB type K0 (ISOL)	TB type L0 (ISOL IO-RED)
DI 8x24 ... 125V DC	x	
DI 8x230VAC	x	
RQ 4x120-230V / 5A CO	x	
AI 4xI HART ISOL	x	x
AQ 4xI HART ISOL	x	x
		
Powerbus infeed	Light gray	Light gray
Powerbus continuer	Dark gray	

Potential groups/color type of the terminal blocks

Potential groups on ET 200SP HA stations come in both a light and a dark version to help you distinguish them:

- Each light-colored terminal block that is fitted in the station starts a new potential group. The first terminal block fitted (on the first carrier module immediately to the right of the interface module) is therefore light-colored.
- Each dark terminal block forms a contact with the supply voltage of the terminal block to its left, thus extending the potential group.

Note the maximum permissible load current depending on the number of I/O modules:

Number of terminal blocks	Permissible load current in amperes
4	10 A
5	8 A
6	7 A
7	6 A
8	5 A
10	4 A
15	3 A
20	2 A

Ordering data**Article No.****Article No.****Terminal blocks 24 V DC****Terminal block type H1 light**

For starting a new potential group, with 32 push-in terminals, width 22.5 mm, with temperature compensation

6DL1193-6TP00-0DH1**Terminal block type M1 light**

For starting a new potential group, with 32 push-in terminals, width 45 mm, for redundant configurations, with temperature compensation

6DL1193-6TP00-0DM1**Terminal block type P0 light**

For starting a new potential group, with 32 push-in terminals, additional 32 push-in terminals with encoder supply, width 45 mm, specially for use with DI 32x24 V DC (6DL1131-6BL00-0PH1)

6DL1193-6TP00-0DP0**Terminal block type N0 light**

For starting a new potential group, with 32 push-in terminals, additional 32 push-in terminals for ground connection, width 45 mm, for use with DQ 32x 24 V DC (6DL1132-6BL00-0PH1) and other modules

6DL1193-6TP00-0DN0**Terminal block type L0 light**

For starting a new potential group, with 16 push-in terminals, width 45 mm

6DL1193-6TP00-0DL0**Terminal block type H1 dark**

For forwarding a potential group, with 32 push-in terminals, width 22.5 mm, with temperature compensation

6DL1193-6TP00-0BH1**Terminal block type M1 dark**

For forwarding a potential group, with 32 push-in terminals, width 45 mm, for redundant configurations, with temperature compensation

6DL1193-6TP00-0BM1**Terminal block type P0 dark**

For forwarding a potential group, with 32 push-in terminals, additional 32 push-in terminals with encoder supply, width 45 mm, specially for use with DI 32x24 V DC (6DL1131-6BL00-0PH1)

6DL1193-6TP00-0BP0**Terminal block type N0 dark**

For starting a new potential group, with 32 push-in terminals, additional 32 push-in terminals for ground connection, width 45 mm, for use with DQ 32x 24 V DC (6DL1132-6BL00-0PH1) and other modules

6DL1193-6TP00-0BN0**Terminal block type F1 black**

32 push-in terminals, width 45 mm, for redundant configuration with fail-safe analog module F-AI, no powerbus

6DL1193-6TP00-0DF1**Terminal block type H0, D-sub, black**

D-Sub plug 37-pin, 24 V infeed per TB, width 22.5 mm, no powerbus

6DL1193-6TC00-0DH0**Terminal blocks insulated (24 V DC / 125 V DC / 230 V AC)****Terminal block type K0 light**

For starting a new potential group, with 16 push-in terminals, width 22.5 mm

6DL1193-6TP00-0DK0**Terminal block type K0 dark**

For forwarding a potential group, with 16 push-in terminals, width 22.5 mm

6DL1193-6TP00-0BK0**Accessories****Shield connection for terminal block**

5 shield supports and 5 shield terminals, for direct connection

6ES7193-6SC00-1AM0

Technical specifications

Article number	6DL1193-6TP00-0DH1 Terminal block, Type H1, light-grey	6DL1193-6TP00-0BH1 Terminal block, Type H1, dark-grey	6DL1193-6TP00-0DM1 Terminal block, Type M1, light-grey	6DL1193-6TP00-0BM1 Terminal block, Type M1, dark-grey	6DL1193-6TP00-0DP0 Terminal block, Type P0, light-grey	6DL1193-6TP00-0BP0 Terminal block, Type P0, dark-grey
General information						
Product type designation	Type H1	Type H1	Type M1	Type M1	Type P0	Type P0
Product function						
• I&M data	Yes; Asset data	Yes; Asset data	Yes; Asset data	Yes; Asset data	Yes	Yes
Input current						
Current consumption, max.					640 mA; With one 20 mA encoder supply per channel	640 mA; With one 20 mA encoder supply per channel
Hardware configuration						
Slots						
• Number of slots	1	1	2; For IO redundancy	2; For IO redundancy	1	1
Ambient conditions						
Ambient temperature during operation						
• horizontal installation, min.	-40 °C	-40 °C	-40 °C	-40 °C	-40 °C	-40 °C
• horizontal installation, max.	70 °C	70 °C	70 °C	70 °C	70 °C	70 °C
• vertical installation, min.	-40 °C	-40 °C	-40 °C	-40 °C	-40 °C	-40 °C
• vertical installation, max.	60 °C	60 °C	60 °C	60 °C	60 °C	60 °C
Dimensions						
Width	22.5 mm	22.5 mm	45 mm	45 mm	45 mm	45 mm
Height	175 mm	175 mm	175 mm	175 mm	175 mm	175 mm
Depth	77 mm	77 mm	77 mm	77 mm	77 mm	77 mm
Weights						
Weight, approx.	80 g	80 g	155 g	155 g	155 g	155 g
Article number	6DL1193-6TP00-0DN0 Terminal block, Type N0, light-grey	6DL1193-6TP00-0BN0 Terminal block, Type N0, dark-grey	6DL1193-6TP00-0DK0 Terminal block, Type K0, light-grey	6DL1193-6TP00-0BK0 Terminal block, Type K0, dark-grey		
General information						
Product type designation	Type N0	Type N0	Type K0	Type K0		
Product function						
• I&M data	Yes	Yes	Yes; Asset data	Yes; Asset data		
Hardware configuration						
Slots						
• Number of slots	1	1	1	1		
Ambient conditions						
Ambient temperature during operation						
• horizontal installation, min.	-40 °C	-40 °C	-40 °C	-40 °C		
• horizontal installation, max.	70 °C	70 °C	70 °C	70 °C		
• vertical installation, min.	-40 °C	-40 °C	-40 °C	-40 °C		
• vertical installation, max.	60 °C	60 °C	60 °C	60 °C		
Dimensions						
Width	45 mm	45 mm	22.5 mm	22.5 mm		
Height	175 mm	175 mm	175 mm	175 mm		
Depth	77 mm	77 mm	77 mm	77 mm		
Weights						
Weight, approx.	155 g	155 g	78 g	78 g		

SIMATIC PCS 7 system hardware

Process I/O

SIMATIC ET 200SP HA

Terminal blocks**Technical specifications** (continued)

Article number	6DL1193-6TP00-0DF1	6DL1193-6TC00-0DH0
	Terminal block, Type F1, F-AI, IO-RED	Terminal block, Type H0, D-SUB
General information		
Product type designation	Type F1	type H0, SUB-D
Product function		
• I&M data	Yes; Asset data	Yes; Asset data
Hardware configuration		
Slots		
• Number of slots	2; For IO redundancy	1
Ambient conditions		
Ambient temperature during operation		
• horizontal installation, min.	-40 °C	-40 °C
• horizontal installation, max.	70 °C	70 °C
• vertical installation, min.	-40 °C	-40 °C
• vertical installation, max.	60 °C	60 °C
Dimensions		
Width	45 mm	22.5 mm
Height	175 mm	175 mm
Depth	77 mm	77 mm
Weights		
Weight, approx.	160 g	80 g

Overview



BusAdapter BA 2xRJ45, 2xFC and 2xLC

BusAdapter

A BusAdapter as a separate component allows a free choice of connection technology:

- BA 2xRJ45: 2 electrical connections for bus cable with standard RJ45 connector
- BA 2xFC: 2 electrical connections for direct connection of FastConnect bus cable
- BA 2xLC: 2 optical ports for fiber-optic cables

Ordering data

Article No.

BusAdapter	Article No.
BusAdapter 2xRJ45 2 × RJ45 sockets for PROFINET (standard Ethernet socket)	6DL1193-6AR00-0AA0
BusAdapter 2xFC 2 × FastConnect (FC) connections for PROFINET	6DL1193-6AF00-0AA0
BusAdapter 2xLC 2 × glass fiber-optic connections for PROFINET	6DL1193-6AG00-0AA0
BusAdapter BA LC/RJ45 2 × glass fiber-optic connections	6DL1193-6AG20-0AA0
BusAdapter BA LC/FC 2 × glass fiber-optic connections	6DL1193-6AG40-0AA0
BusAdapter BA 2xRJ45 (VD) 2 × electrical connections for Ethernet communication via 2-, 4- or 8-wire copper cables and distances up to 500 m	6GK5991-2VA00-8AA2

Technical specifications

Article number	6DL1193-6AR00-0AA0	6DL1193-6AF00-0AA0	6DL1193-6AG00-0AA0
	ET 200SP HA, Busadapter BA 2XRJ45	ET 200SP HA, Busadapter BA 2XFC	ET 200SP HA, Busadapter BA 2XLC
General information			
Product type designation	BA 2x RJ45	BA 2xFC	BA 2xLC
Interfaces			
Number of PROFINET interfaces	1; 2 ports (switch) RJ45	1; 2 ports (switch) FC	1; 2 ports (switch) LC Multimode Glass Fibre
Supports protocol for PROFINET IO			
• Number of RJ45 ports	2		
• Number of FC (FastConnect) connections		2	
• Number of LC ports			2
Cable length			
- Cu conductors	100 m	100 m	
- Multimode graded-index fiber 50/125 μm			3 km
- Multimode graded-index fiber 62.5/125 μm			3 km
Ambient conditions			
Ambient temperature during operation			
• min.	-40 °C	-40 °C	-40 °C
• max.	70 °C	70 °C	65 °C; redundant design (2x 6DL1155-6AU00-0PM0): max. 60 °C horizontal, max. 50 °C vertical. When using different I/O devices, the derating specified there must be observed
Dimensions			
Width	20 mm	20 mm	20 mm
Height	69.5 mm	69.5 mm	75 mm; Without protective caps (approx. 8 mm)
Depth	59 mm	59 mm	59 mm
Weights			
Weight, approx.	46 g	53 g	60 g

SIMATIC PCS 7 system hardware

Process I/O

SIMATIC ET 200SP HA

Additional I/O modules

Overview

Extending the SIMATIC ET 200SP HA system with specific additional I/O modules from the SIMATIC ET 200SP system gives you more options and flexibility.

When these I/O modules are used, the following aspects need to be considered:

- Special slot rules apply. The additional I/O modules from the SIMATIC ET 200SP system can only be operated at the end, after the Standard SIMATIC ET 200SP HA I/O modules. Mixed configuration is not permissible.
- Module redundancy is not supported for the additional I/O modules.
- Attention must be paid to the specific properties of the additional I/O modules, such as ambient temperature, painting, insulation protection. These are usually limited compared to the ET 200SP HA I/O modules.

Analog input module AI Energy Meter Standard, 480 V AC, BU type D0

- Can be plugged into type D0 BaseUnits (BU) with automatic coding
- LED display for error, operation, power, and status
- Clear labeling on front of module
- Optional labeling accessories
- Optional module-specific color coding of the terminals according to the CC color code

SIWAREX WP321 weighing controller

A versatile and flexible weigh beams for the seamless integration of a static scale into the SIMATIC automation environment.

The electronic weighing system is integrated in the SIMATIC ET 200SP series and uses all the features of a modern automation system, such as integrated communication, operator control and monitoring, diagnostic systems and configuration tools in the TIA Portal, SIMATIC STEP 7, WinCC flexible and PCS 7.

Valve terminal AirLINE SP type 8647 for integration in ET 200SP HA

- For pneumatic control of actuators with ET 200SP HA
- Can be used together with system and IO components of the ET 200SP HA distributed I/O system
- Bürkert Fluid Control Systems product, can only be obtained from Bürkert Fluid Control Systems product partner

Note:

Product partners are external companies outside Siemens AG and its associated companies. Information and descriptions of products made by product partners are non-binding, and are the responsibility of the product partners. These products are manufactured independently and under the responsibility of the respective product partner, and are sold and supplied by it under its terms of business and delivery.

Unless compulsory by law, Siemens assumes no liability or warranty for these products or for connection with these products of the product partners.

Ordering data

Article No.

Analog input module

AI Energy Meter
Standard 480 V AC, BU type D0

6ES7134-6PA20-0BD0

SIWAREX WP321 weighing controller

Single-channel, for platform scales or hopper scales with analog load cells (1–4 mV/V), 1 × LC, 1 × RS 485.

7MH4138-6AA00-0BA0

Valve terminal AirLINE SP type 8647 for integration in ET 200SP HA

For more detailed information about the AirLINE SP, type 8647 (e.g. data sheet, operating manual) please contact Bürkert directly:
<https://www.burkert-usa.com/en/type/8647>

* Disclaimer of liability

This information and the descriptions have been compiled with great care. However, it is not possible for Siemens to verify that the data supplied by product partners is complete, correct and up-to-date. The possibility that individual items of information might be incorrect, incomplete, or not up-to-date cannot therefore be ruled out. Unless compulsory by law, Siemens accepts no liability for the usability of the data or of the products for the user per se.

Overview



The ET 200iSP is a modular, intrinsically-safe I/O system with IP30 degree of protection which can be operated in gas and dust atmospheres at ambient temperatures from -20 to +70 °C. It is optimized for use with SIMATIC PCS 7 and SIMATIC S7, but can also be integrated in other systems such as SIMATIC S5 per GSD file.

In accordance with ATEX directive 2014/34/EU, the ET 200iSP remote I/O stations can be installed directly in Ex Zones 1, 2, 21 or 22 as well as in non-hazardous areas. The intrinsically-safe sensors, actuators and HART field devices can also be located in zone 0 or 20 if necessary.

The modular design of the ET 200iSP makes it possible to optimally adapt the remote I/O stations to the respective automation task through individual configuration and flexible expansion. To increase plant availability, the pressure-encapsulated power supply and the intrinsically-safe PROFIBUS DP connection (RS 485-iS) of the stations can also be of redundant design.

The modern architecture with hardwiring and automatic slot coding supports pre-wiring without the electronic modules, simple and reliable hot swapping of individual modules without a fire certificate as well as configuration in run (CiR).

In addition to analog and digital I/O modules for the automation of technological functions of the process (Basic Process Control), the range of electronic modules also includes fail-safe I/O modules for implementing safety applications. The various types of electronic module can be arranged mixed within a station. Comprehensive diagnostic options facilitate commissioning and troubleshooting.

Design

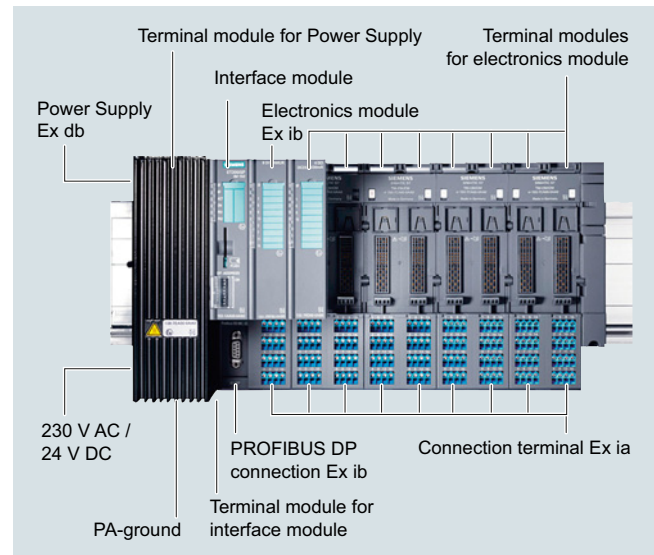

Main components of the ET 200iSP distributed I/O system:

- Terminal modules mounted on an S7-300 rail; for connecting power supply, interface, electronics, watchdog and reserve modules and for prewiring
 - with blue screw-type or spring-loaded terminals for hazardous environments
 - with black screw-type terminals for non-hazardous environments
- Power supply unit
 - 1 or 2 (redundant) power supply modules PS with pressurized enclosure for feeding 24 V DC or 120/230 V AC
- Interface module
 - 1 or 2 (redundant) IM 152 interface modules for connecting the station to the PROFIBUS DP
- Electronics modules (2/4/8 channels): Up to 32 in any combination
 - Digital electronics modules (DI, DO)
 - Analog electronics modules (AI, AO)
 - Safety-related electronics modules (F-DI, F-DO and F-AI)
 - Watchdog module
- Accessories
 - Reserve module for reserving a slot for any electronics module
 - Terminating module (included in scope of delivery of terminal modules for the PROFIBUS interface)
 - Labeling sheets with printable labeling strips
 - Inscription labels for slot numbering

Assembly

Assembly is quick and easy:

- Latching of terminal modules onto the S7-300 rail
- Prewiring of process signal cables on the terminal modules using spring-loaded or screw-type connections
- Plugging-in of power supply, interface and electronics modules without the need for additional tools

SIMATIC PCS 7 system hardware

Process I/O

SIMATIC ET 200iSP

Design (continued)

Expansion limits

The station width is 107 cm in the maximum configuration with 32 electronic modules.

The maximum number of electronics modules which can be used per station may be limited depending on the current consumption of the modules required to solve the automation task. However, up to 16 electronics modules can be used without limitation.

Stainless steel wall enclosure

If the ET 200iSP is used in a hazardous area, it must be installed in an appropriate Ex housing which at least corresponds to the IP54 degree of protection. Appropriate versions of an IP65 housing are offered in the Section "Stainless steel wall housings".

Outstanding design features

- Installation and testing of the wiring is possible in advance without the electronics module (independent wiring).
- Isolation of the mechanical and electronic systems, in conjunction with the independent process wiring, permits fast and easy replacement of the electronics modules
- Mechanical coding which is carried out when an electronics module is plugged onto a terminal module for the first time prevents the connection of incorrect replacement modules
- Hot swapping of the power supply modules and electronics modules is possible without a fire certificate.

Integration

Distributed ET 200iSP remote I/O stations are connected to the automation systems (controllers) via the PROFIBUS DP, which can be routed intrinsically-safe into Ex-zone 1 using an isolating transformer (RS 485-iS coupler) as barrier. Data transfer rates of up to 1.5 Mbps are possible. The ET 200iSP remote I/O stations can be connected to the controller as DP V0 slave or DP V1 slave.

The ET 200iSP remote I/O stations are integrated into the SIMATIC PCS 7 process control system using standard driver blocks.

The existing standard diagnostics drivers process the diagnostics messages generated by internal or external faults (e.g. wire breakage or short-circuit) as well as status messages of the connected HART field devices for the host operator system and the SIMATIC PCS 7 maintenance station.

Vendor-specific information and maintenance data are saved powerfail-proof on the electronics modules.

Configuration

The ET 200iSP stations can be configured and parameterized per HW Config in a SIMATIC S7/SIMATIC PCS 7 environment. Parameters of the ET 200iSP stations and the HART field devices can also be set using the process device manager, SIMATIC PDM. Routing via PROFIBUS DP enables direct access to the HART field devices on the ET 200iSP with SIMATIC PDM.

The system function CiR (Configuration in Run) is also supported for the configuration of SIMATIC PCS 7 and permits the following changes to be made to the configuration during runtime:

- Adding of ET 200iSP stations
- Adding modules to the ET 200iSP station
- Re-configuration of modules
- Parameterization of connected HART field devices with SIMATIC PDM

Software minimum requirements

- SIMATIC PCS 7 environment: SIMATIC PCS 7 Version 6.1
- SIMATIC S7 environment: SIMATIC STEP 7 Version 5.3+SP1 including Hardware Support Package (HSP) or SIMATIC STEP 7 (TIA Portal)
- The latest SIMATIC PDM version is used to configure the HART field devices.

Configuration with third-party systems and old SIMATIC PCS 7/STEP 7 versions

The station design (configuration) should be published over the PROFIBUS DP network per GSD file.

Process Device Manager SIMATIC PDM is required for the configuration. It can be used to define, for example, alarm limits for analog modules, signal encoders for digital modules as well as settings for outputting analog values and HART commands for analog HART modules.

Technical specifications

ET 200iSP – general	
Degree of protection	IP30
Ambient temperature	
• Horizontal mounting position	-20 ... +70 °C
• Other mounting positions	-20 ... +50 °C
Loading of media	According to ISA-S71.04 severity level G1; G2; G3 (except for NH3, only level G2 in this case)
EMC	Electromagnetic compatibility according to NE21
Vibration resistance	0.5 g continuously, 1 g periodically
Approvals, standards	
• ATEX	II 2 G (1) GD Ex de [ia/ib] IIC T4 I M2 Ex de [ia/ib] I
• IECEx	Zone 1 Ex de [ia/ib] IIC T4
• INMETRO	Zone 1 BR-Ex de [ia/ib] IIC T4
• cFMus	Class I, II, III NI Division 2, Groups A, B, C, D, E, F, G T4 AIS Division 1, Groups A, B, C, D, E, F, G
• cULus	Class I Zone 1, AEx de [ia/ib] IIC T4 Class I, II, III Division 2, Groups A, B, C, D, E, F, G T4 providing int. safe circuits for Division 1, Groups A, B, C, D, E, F, G
• NEPSI	Class I Zone 1, AEx de [ia/ib] IIC T4 Ex de ib[ia] IIC T4 Ex de [ia/ib] IIC T4
• PROFIBUS	EN 50170, Volume 2
• IEC	IEC 61131, Part 2
• CE	In accordance with ATEX directive 2014/34/EU, EMC Directive 2014/30/EU and LVD-guideline 2014/35/EU
• KCC	Korea Certification
• Marine approval	Classification companies • ABS (American Bureau of Shipping) • BV (Bureau Veritas) • DNV (Det Norske Veritas) • GL (Germanischer Lloyd) • LRS (Lloyds Register of Shipping) • Class NK (Nippon Kaiji Kyokai)

Overview



An ET 200iSP power supply unit consists of a TM-PS terminal module (A or B) and a PS power supply module which is plugged onto this. Terminal modules and power supply modules can be ordered separately.

The power supply modules are suitable for both individual operation (standard) and redundant operation. Depending on the operating mode, they must be combined with the terminal modules as follows:

- Standard: 1 × PS on TM-PS-A UC
- Redundancy: 1 × PS on TM-PS-A UC (left) plus 1 × PS on TM-PS-B UC (right)

Power supply modules are available for supplies of 24 V DC and 120/230 V AC.

The operating state of the power supply modules is indicated by two LEDs on the IM 152 interface module (one for each module).

Application

Functions of the power supply modules

- Supply of ET 200iSP with safely isolated operating voltages for
 - Powerbus (for supplying the electronics modules)
 - Backplane bus (logic)
 - Interface module (IM 152-1)
- Safety-related limiting of output voltages

Design

Depending on the operating mode (standard or redundant), one or two power supply modules are plugged onto the corresponding terminal modules. In standard mode, a PS power supply module is combined with a TM-PS-A terminal module. In redundant mode, a second power supply unit is provided on the right of the first one. This consists of a PS power supply module and a TM-PS-B terminal module.

The power supply modules can also be used in hazardous areas. The explosion protection is guaranteed by an explosion-proof metal enclosure (explosion protection EEx d).

The power source (24 V DC or 120/230 V AC) must be installed in the safe area. It is connected to the terminal module of the power supply unit via EEX e terminals. The power source may only be connected or disconnected in a safe operating environment and not in hazardous areas.

The power supply module is moved into its working position by means of a slide system, and manually fixed there by means of a mechanical lock. Replacement through disconnection of the existing power supply module and insertion of a new module is also permissible in the hazardous area. To replace the module, the mechanical lock must first be released to remove the module from its working position using the slide.

Ordering data

Article No.

PS 24 V DC power supply module for ET 200iSP	6ES7138-7EA01-0AA0
PS 120/230 V AC power supply module for ET 200iSP	6ES7138-7EC00-0AA0
TM-PS-A UC terminal module For standard operation	6ES7193-7DA20-0AA0
TM-PS-B UC terminal module Additional terminal module for redundant operation	6ES7193-7DB20-0AA0

SIMATIC PCS 7 system hardware

Process I/O

SIMATIC ET 200iSP

Power supply unit**Technical specifications**

Article number	6ES7138-7EA01-0AA0 ET200iSP, POWER SUPPLY MODULE	6ES7138-7EC00-0AA0 ET200iSP, POWER SUPPLY MOD. AC120/230V
Supply voltage		
Rated value (DC)	24 V	
Rated value (AC)		230 V; 120/230 V AC
Reverse polarity protection	Yes	
Line frequency		
• permissible range, lower limit		47 Hz
• permissible range, upper limit		63 Hz
Input current		
from supply voltage L+, max.	4 A	
from supply voltage L1, max.		1.04 A; at rated voltage 230 VAC:0.45A at rated voltage 120 VAC:0.75A
Interrupts/diagnostics/ status information		
Status indicator	Yes	Yes
Alarms	No	No
Diagnoses		
• Diagnostic information readable	Yes; via IM 152	Yes; via IM 152
Diagnostics indication LED		
• Group error SF (red)	No	No
Potential separation		
primary/secondary	Yes	Yes
between supply voltage and electronics	Yes	No
Standards, approvals, certificates		
CE mark	Yes	Yes
Use in hazardous areas		
• Type of protection acc. to EN 50020 (CENELEC)	Ex de [ib]IIC T4	Ex de [ib]IIC T4
• Type of protection acc. to KEMA	04 ATEX 2263	09 ATEX 0156
Dimensions		
Width	60 mm	60 mm
Height	190 mm	190 mm
Depth	136.5 mm	136.5 mm
Weights		
Weight, approx.	2 700 g	2 700 g
Article number	6ES7193-7DA20-0AA0 ET200iSP, TERM.-MOD. TM-PS-A UC	6ES7193-7DB20-0AA0 ET200iSP, TERM.-MOD. TM-PS-B UC
Standards, approvals, certificates		
CE mark	Yes	Yes
Use in hazardous areas		
• Type of protection acc. to EN 50020 (CENELEC)	see ET 200iSP system	see ET 200iSP system
• Test number KEMA	04 ATEX 2242	04 ATEX 2242
Dimensions		
Width	60 mm	60 mm
Height	190 mm	190 mm
Depth	52 mm	52 mm
Weights		
Weight, approx.	230 g	230 g

Overview



The IM 152 interface module connects the ET 200iSP to the PROFIBUS DP with intrinsically-safe RS 485-iS transmission technology with transmission rates of up to 1.5 Mbps. A redundant connection is also possible. In this case the ET 200iSP is connected via two interface modules to two redundant PROFIBUS DP segments of a fault-tolerant automation system.

The IM 152 is plugged onto a special terminal module (to be ordered separately). The following terminal modules are available:

- TM-IM/IM terminal module for two interface modules (for redundant PROFIBUS DP connection)
- TM-IM/EM60 terminal module for one interface module and one watchdog, reserve or electronic module (except 2 DQ relay)
 - with blue screw-type or spring-loaded terminals for hazardous environments
 - with black screw-type terminals for non-hazardous environments

Tasks of the IM 152 interface module

- Connection of ET 200iSP to the intrinsically-safe PROFIBUS DP
- Autonomous communication with the host automation system
- Preparation of data for the fitted electronic modules
- Saving of parameters of the electronic modules
- Time stamping of digital process signals with an accuracy of 20 ms

The maximum address space of the interface module is 244 bytes for inputs, and 244 bytes for outputs.

Design

The terminal module of the IM 152 (TM-IM/EM or TM-IM/IM) is connected directly next to the power supply unit on the DIN rail. The PROFIBUS DP connection of the IM 152 is made using the standard Sub-D socket on the terminal module. The matching connection element we provide is a special terminating plug with selectable terminating resistance. The terminating resistance must be activated on the last ET 200iSP station of each PROFIBUS DP segment.

Hot swapping of the IM 152 and the PROFIBUS connector is permissible under hazardous conditions.

A terminating module is provided together with the IM 152, and must be fitted at the right end of each ET 200iSP station following the last electronics module.

The IM 152 has a slot for micro memory cards (MMC). The firmware can therefore be updated either via the PROFIBUS DP or using MMCs.

The PROFIBUS addresses can be set using DIP switches at the front which are protected by a cover.

LEDs on the front of the IM 152 signal the supply voltage, group faults, bus faults, the active IM with redundant operation, and the operating state of the fitted power supply modules.

SIMATIC PCS 7 system hardware

Process I/O

SIMATIC ET 200iSP

Interface module

Ordering data	Article No.	Accessories	Article No.
ET 200iSP interface module IM 152-1	6ES7152-1AA00-0AB0	PROFIBUS connector with selectable terminating resistor For connection of IM 152 to PROFIBUS DP with RS 485-iS transmission technology	6ES7972-0DA60-0XA0
ET 200iSP terminal module TM-IM/EM60 For an IM 152 and a watchdog, reserve or electronics module (except 2 DO relay), including terminating module		RS 485-iS coupler Isolating transformer for connection of PROFIBUS DP segments with RS 485 and RS 485-iS transmission technologies	6ES7972-0AC80-0XA0
<ul style="list-style-type: none"> • For hazardous environments <ul style="list-style-type: none"> - TM-IM/EM60S (blue screw-type terminals) - TM-IM/EM60C (blue spring-loaded terminals) • For non-hazardous environments <ul style="list-style-type: none"> - TM-IM/EM60S (black screw-type terminals) 	6ES7193-7AA00-0AA0	Labeling sheet DIN A4, perforated, each consisting of 10 sheets of 30 strips each for electronics modules and 20 strips each for IM 152	
	6ES7193-7AA10-0AA0	<ul style="list-style-type: none"> • petrol • yellow 	6ES7193-7BH00-0AA0 6ES7193-7BB00-0AA0
ET 200iSP terminal module TM-IM/IM For two IM 152 modules (redundant operation), including terminating module	6ES7193-7AB00-0AA0	Labels, inscribed For slot numbering, label size H × W (in mm): 5 × 7	
		<ul style="list-style-type: none"> • 204 labels, for slots 1 to 20 • 204 labels, for slots 1 to 40 • 136 labels, inscription in plain text 	8WA8361-0AB 8WA8361-0AC 8WA8348-0XA
		Labels, blank 136 labels for slot numbering, label size H × W (in mm): 5 × 7	8WA8348-2AY
		S7-300 mounting rails	
		<ul style="list-style-type: none"> • 585 mm long, suitable for assembly of ET 200iSP in a 650 mm wide wall box • 885 mm long, suitable for assembly of ET 200iSP in a 950 mm wide wall box 	6ES7390-1AF85-0AA0 6ES7390-1AJ85-0AA0

Technical specifications

Article number	6ES7152-1AA00-0AB0 ET200iSP, IM152-1 INTERFACE MODULE
General information	
Product function	
• Isochronous mode	No
Input current	
from supply voltage L+, max.	30 mA
Time stamping	
Description	for each digital input, digital input module, total ET 200iS
Accuracy	20 ms
Number of stampable digital inputs, max.	64; for accuracy class 20 ms max.
Time format	RFC 1119 Internet (ISP)
Time resolution	1 ms
Time interval for transmitting the message buffer if a message is present	1 000 ms
Time stamp on signal change	rising / falling edge as signal entering or exiting
Interfaces	
Transmission rate, max.	1.5 Mbit/s
Protocols	
PROFIBUS DP	Yes
PROFIBUS DP	
Services	
- SYNC capability	Yes
- FREEZE capability	Yes
- Direct data exchange (slave-to-slave communication)	Yes; Slave to slave as publisher

Article number	6ES7152-1AA00-0AB0 ET200iSP, IM152-1 INTERFACE MODULE
Interrupts/diagnostics/ status information	
Alarms	Yes
Diagnostics function	Yes
Alarms	
• acyclic function, interrupts	Yes
• acyclic function, parameters	Yes
Diagnostics indication LED	
• Bus fault BF (red)	Yes
• Group error SF (red)	Yes
• Monitoring 24 V voltage supply ON (green)	Yes
Potential separation	
between supply voltage and electronics	Yes
Standards, approvals, certificates	
CE mark	Yes
Use in hazardous areas	
• Type of protection acc. to EN 50020 (CENELEC)	I/2 G Ex ib IIC T4 and I M2 Ex ib I
• Type of protection acc. to KEMA	04 ATEX 1243
Dimensions	
Width	30 mm
Height	129 mm
Depth	136.5 mm
Weights	
Weight, approx.	245 g

Article number	6ES7193-7AA00-0AA0 ET200iSP, TERM.-MOD. TM-IM/EM60S, SCREW	6ES7193-7AA10-0AA0 ET200iSP, TERM.-MOD. TM-IM/EM60C ,SPRING	6ES7193-7AB00-0AA0 ET200iSP, TERM.-MOD. TM-IM/IM F. TWO IM
Standards, approvals, certificates			
CE mark	Yes	Yes	Yes
Use in hazardous areas			
• Type of protection acc. to EN 50020 (CENELEC)	see ET 200iSP system	see ET 200iSP system	see ET 200iSP system
• Test number KEMA	04 ATEX 2242	04 ATEX 2242	04 ATEX 2242
Dimensions			
Width	60 mm	60 mm	60 mm
Height	190 mm	190 mm	190 mm
Depth	52 mm	52 mm	52 mm
Weights			
Weight, approx.	235 g	235 g	195 g

SIMATIC PCS 7 system hardware

Process I/O

SIMATIC ET 200iSP

Digital electronic modules

Overview



Digital input modules

- 8-channel digital input module DI NAMUR EEx i, for evaluation of NAMUR sensors, connected and non-connected contacts, as well as for use as counter or frequency meter
Parameterizable connections:
 - NAMUR sensor on/off
 - NAMUR changeover contact
 - Single contact connected (mechanical NO contact)
 - Changeover contact connected (mechanical changeover contact)
 - Single contact non-connected (mechanical NO contact with single contact)
 - Changeover contact non-connected (mechanical changeover contact)
 - Counting function: optional use of 2 channels for recording counter pulses or for frequency measurement
 - Short-circuit and wire break monitoring

Digital output modules

- 4-channel digital output modules DO EEx i, 23.1 V DC/20 mA, 17.4 V DC/27 mA, 17.4 V DC/40 mA or 25.5 V DC/22 mA, with external actuator switch-off via High or Low signal (H/L switch-off)
 - Load-free switching of outputs via external intrinsically-safe signal
 - Power boosting through parallel connection of two outputs for one actuator with 4 DO 17.4 V DC/27 mA or 4 DO 17.4 V DC/40 mA
 - Short-circuit and wire break monitoring
- 2-channel digital output module DO Relay EEx e, e.g. for switching solenoid valves, DC contactors or signaling lamps
 - Can be plugged onto TM-RM/RM terminal module
 - Output current up to 2 A with 60 V UC for each of the two relay outputs
 - Installation up to Ex zone 1
 - Intrinsically-safe and non-intrinsically-safe signals can be mixed in a station

Extra functions

Actuator shutdown function of the 4 DO EEx i modules

The 4 DO EEx i modules are equipped with a shutdown function. This permits implementation of an external switch-off independent of the automation system (controller).

As soon as the intrinsically-safe switch-off signal (High or Low) is present at the actuator switch-off input of the electronics module, its outputs are deactivated.

You can also combine several DO modules into a switch-off group. The intrinsically-safe power supply for the switch-off device is either via the watchdog module or a separate intrinsically-safe source.

Design

- The digital electronics modules are installed on terminal modules which must be ordered separately.
 - TM-IM/EM60 terminal modules for one interface module and one watchdog, reserve or electronics module (for versions, see section Interface module)
 - TM-EM/EM60 terminal modules with two slots for watchdog module, reserve module or electronics module (except 2 DO relay), with blue screw-type or spring-loaded terminals for hazardous environments or with black screw-type terminals for non-hazardous environments
 - TM-RM/RM 60 terminal modules with two slots for relay or reserve modules
- The digital electronics module 2 DO Relays must be plugged onto the terminal module TM-RM/RM 60S (screw-type connection system). All other digital electronics modules are plugged as planned onto terminal modules using screw-type systems (TM-EM/EM60S) or spring-loaded systems (TM-EM/EM60C).
- Using a spare module plugged onto a terminal module TM-EM/EM60S, TM-EM/EM60C or TM-RM/RM 60S, you can reserve a slot for a digital electronics module or close a gap resulting from the design. The spare module can be simply replaced by the envisaged electronics module at a later point in time.
- The mechanical coding of the terminal module which is carried out when an electronics module is plugged on for the first time prevents the connection of incorrect replacement modules.
- Hot swapping of individual modules is possible under hazardous conditions.
- The process signals are connected to the terminals of the terminal modules assigned according to the plan, using either conventional screw-type or spring-loaded systems (conductor cross-sections 0.14 mm² to max. 2.5 mm²) depending on the type of module.

Ordering data	Article No.	Article No.	
Digital input modules			
<u>Digital input modules EEx i</u>			
8 DI NAMUR For evaluation of NAMUR sensors, connected/non-connected contacts, as well as for recording counter pulses or measuring frequencies <ul style="list-style-type: none"> • 8 × NAMUR (NAMUR sensor on/off, NAMUR changeover contact) or connected/non-connected inputs (single/changeover contact) • 2 channels optionally usable as counters (max. 5 kHz) or frequency meters (1 Hz ... 5 kHz) • Time tagging 20 ms, rising or falling edge • Wire break monitoring • Short-circuit monitoring • Sensor power supply monitoring • Flutter monitoring 	6ES7131-7RF00-0AB0		
Digital output modules			
<u>Digital output modules EEx i with H-switch-off</u> (external actuator switch-off via H-signal); for switching of solenoid valves, DC relays, signal lamps, actuators			
4 DO DC 23.1 V/20 mA <ul style="list-style-type: none"> • 4 channels with 20 mA each • Short-circuit monitoring • Wire break monitoring • Configurable connection of substitute value in the event of CPU failure • Load-free switching of outputs via external intrinsically-safe signal 	6ES7132-7RD01-0AB0	Digital output modules EEx i with L-switch-off (external actuator switch-off via L-signal); for switching of solenoid valves, DC relays, signal lamps, actuators 4 DO DC 23.1 V/20 mA <ul style="list-style-type: none"> • 4 channels with 20 mA each • Short-circuit monitoring • Wire break monitoring • Configurable connection of substitute value in the event of CPU failure • Load-free switching of outputs via external intrinsically-safe signal 	6ES7132-7GD00-0AB0
4 DO DC 17.4 V/27 mA <ul style="list-style-type: none"> • 4 channels with 27 mA each or 2 outputs connected in parallel with 54 mA each • Short-circuit monitoring • Wire break monitoring • Configurable connection of substitute value in the event of CPU failure • Load-free switching of outputs via external intrinsically-safe signal 	6ES7132-7RD11-0AB0	4 DO DC 17.4 V/27 mA <ul style="list-style-type: none"> • 4 channels with 27 mA each or 2 outputs connected in parallel with 54 mA each • Short-circuit monitoring • Wire break monitoring • Configurable connection of substitute value in the event of CPU failure • Load-free switching of outputs via external intrinsically-safe signal 	6ES7132-7GD10-0AB0
4 DO DC 17.4 V/40 mA <ul style="list-style-type: none"> • 4 channels with 40 mA each or 2 outputs connected in parallel with 80 mA each • Short-circuit monitoring • Wire break monitoring • Configurable connection of substitute value in the event of CPU failure • Load-free switching of outputs via external intrinsically-safe signal 	6ES7132-7RD22-0AB0	4 DO DC 17.4 V/40 mA <ul style="list-style-type: none"> • 4 channels with 40 mA each or 2 outputs connected in parallel with 80 mA each • Short-circuit monitoring • Wire break monitoring • Configurable connection of substitute value in the event of CPU failure • Load-free switching of outputs via external intrinsically-safe signal 	6ES7132-7GD21-0AB0
		4 DO DC 25.5 V/22 mA¹⁾ <ul style="list-style-type: none"> • 4 channels with 22 mA each • Short-circuit monitoring • Wire break monitoring • Configurable connection of substitute value in the event of CPU failure • Load-free switching of outputs via external intrinsically-safe signal 	6ES7132-7GD30-0AB0
		<u>Digital output modules EEx e</u> For switching of solenoid valves, DC contactors or indicator lights 2 DO Relay, 60 V UC, 2 A <ul style="list-style-type: none"> • Can be plugged onto TM-RM/RM terminal module • Output current up to 2 A with 60 V UC for each of the two relay outputs • Installation up to Ex zone 1 • Configurable connection of substitute value in the event of CPU failure 	6ES7132-7HB00-0AB0

SIMATIC PCS 7 system hardware

Process I/O

SIMATIC ET 200iSP

Digital electronic modules

Ordering data

Terminal modules

ET 200iSP terminal module TM-EM/EM60

For two modules (reserve module, watchdog module and all electronics modules except 2 DO Relay can be plugged in)

- For hazardous environments
 - TM-EM/EM60S (blue screw-type terminals)
 - TM-EM/EM60C (blue spring-loaded terminals)
- For non-hazardous environments
 - TM-EM/EM60S (black screw-type terminals)

Article No.

6ES7193-7CA00-0AA0

6ES7193-7CA10-0AA0

6ES7193-7CA20-0AA0

ET 200iSP terminal module TM-RM/RM 60

For two modules (electronics module 2 DO Relay and reserve module can be plugged-in)

- TM-RM/RM60S (screw-type terminals)

6ES7193-7CB00-0AA0

Accessories

Reserve module

For any electronics module

6ES7138-7AA00-0AA0

Labeling sheet

DIN A4, perforated, each consisting of 10 sheets of 30 strips each for electronics modules and 20 strips each for IM 151

- petrol
- yellow

6ES7193-7BH00-0AA0
6ES7193-7BB00-0AA0**Labels, inscribed**

For slot numbering, label size H x W (in mm): 5 x 7

- 204 labels, for slots 1 to 20
- 204 labels, for slots 1 to 40

8WA8361-0AB
8WA8361-0AC**Labels, blank**

136 labels for slot numbering, label size H x W (in mm): 5 x 7

8WA8348-2AY

S7-300 rails

• 585 mm long, suitable for assembly of ET 200iSP in a 650 mm wide wall box

6ES7390-1AF85-0AA0

• 885 mm long, suitable for assembly of ET 200iSP in a 950 mm wide wall box

6ES7390-1AJ85-0AA0

¹⁾ Can be used with SIMATIC PCS 7 V7.1+SP2 or higher

Technical specifications

Article number	6ES7131-7RF00-0AB0 ET200iSP, EL-MOD., 8DI, NAMUR
Input current	
Current consumption, typ.	80 mA
from supply voltage L+, max.	90 mA
Digital inputs	
Number of digital inputs	8
Number of NAMUR inputs	8
Input current	
• for signal "0", max. (permissible quiescent current)	1.2 mA
• for signal "1", min.	2.1 mA
Encoder	
Number of connectable encoders, max.	8
Connectable encoders	
• NAMUR encoder	Yes
Interrupts/diagnostics/status information	
Diagnostics function	Yes
Alarms	
• Diagnostic alarm	Yes; Parameterizable
• Hardware interrupt	No
Diagnoses	
• Diagnostic information readable	Yes
• Short-circuit	Yes; R load < 150 ohms with NAMUR sensor/sensor and NAMUR changeover contact/sensor to DIN 19234
Diagnostics indication LED	
• Group error SF (red)	Yes
• Status indicator digital input (green)	Yes

Article number	6ES7131-7RF00-0AB0 ET200iSP, EL-MOD., 8DI, NAMUR
Integrated functions	
Frequency measurement	Yes; (Gate time) 50 ms; 200 ms; 1 s
• Number of frequency meters	2
Potential separation	
Potential separation digital inputs	
• between the channels	No
• between the channels and backplane bus	Yes
Standards, approvals, certificates	
CE mark	Yes
Use in hazardous areas	
• Type of protection acc. to EN 50020 (CENELEC)	II2 G (1) GD Ex ib[ia] IIC T4 and I M2 Ex ib[ia] I
• Type of protection acc. to KEMA	04 ATEX 1248
Dimensions	
Width	30 mm
Height	129 mm
Depth	136.5 mm
Weights	
Weight, approx.	255 g

Technical specifications (continued)

Article number	6ES7132-7RD01-0AB0	6ES7132-7RD11-0AB0	6ES7132-7RD22-0AB0
	ET200iSP, EL-MOD., 4DO, DC 23,1V, 20MA	ET200iSP, EL-MOD., 4DO, DC 17,4V, 27MA	ET200iSP, EL-MOD., 4DO, DC 17.4V, 40MA
Input current			
Current consumption, typ.	290 mA	260 mA	380 mA
from load voltage L+ (without load), max.	340 mA; with actuator supply	300 mA	400 mA
from backplane bus 3.3 V DC, max.	10 mA	10 mA	
Digital outputs			
Number of digital outputs	4; additionally 1 intrinsically-safe input for H shutdown	4; additionally 1 intrinsically-safe input for H shutdown	4; additionally 1 intrinsically-safe input for H shutdown
Short-circuit protection	Yes	Yes	Yes
No-load voltage U _{ao} (DC)	23.1 V	17.4 V	17.4 V
Internal resistor R _i	275 Ω	150 Ω	167 Ω
Trend key points E			
• Voltage U _e (DC)	17.6 V	13.3 V	10.7 V
• Current I _e	20 mA	27 mA	40 mA; 80 mA when outputs connected in parallel
Output current			
• for signal "1" rated value	0.02 A	0.027 A	0.04 A
Output delay with resistive load			
• "0" to "1", max.	2 ms	2 ms	2 ms
• "1" to "0", max.	1.5 ms	1.5 ms	1.5 ms
Parallel switching of two outputs			
• for uprating	No; for Ex reasons not possible; nor for predecessor	Yes	Yes
Switching frequency			
• with resistive load, max.	100 Hz	100 Hz	100 Hz
• with inductive load, max.	2 Hz	2 Hz	2 Hz
Cable length			
• shielded, max.	500 m	500 m	500 m
• unshielded, max.	500 m	500 m	500 m
Interrupts/diagnostics/status information			
Status indicator	Yes	Yes	Yes
Alarms		No	
Diagnostics function	Yes	Yes	
Alarms			
• Diagnostic alarm	Yes; Parameterizable	Yes; Parameterizable	Yes; Parameterizable
Diagnoses			
• Diagnostic information readable	Yes	Yes	Yes
• Wire-break	Yes; R > 10 kohms, I < 100 μA	Yes	Yes; R > 10 kohms, I < 100 μA
• Short-circuit	Yes; R < 800 ohms (one output), R < 40 ohms (outputs connected in parallel)	Yes	Yes; R < 80 Ohm (one output), R < 40 Ohm (outputs connected in parallel)
Diagnostics indication LED			
• Group error SF (red)	Yes	Yes	Yes
• Status indicator digital output (green)	Yes	Yes	Yes; Per channel
Ex(i) characteristics			
Maximum values for connecting terminals for gas group IIC			
• U _o (no-load voltage), max.			19.4 V
• I _o (short-circuit current), max.			118 mA
• P _o (power output), max.			572 mW
• C _o (permissible external capacity), max.			241 nF; For IIC, 1507 nF for IIB
• L _o (permissible external inductivity), max.			1.7 mH; For IIC, 10.4 mH for IIB

SIMATIC PCS 7 system hardware

Process I/O

SIMATIC ET 200iSP

Digital electronic modules

Technical specifications (continued)

Article number	6ES7132-7RD01-0AB0	6ES7132-7RD11-0AB0	6ES7132-7RD22-0AB0
	ET200iSP, EL-MOD., 4DO, DC 23,1V, 20MA	ET200iSP, EL-MOD., 4DO, DC 17,4V, 27MA	ET200iSP, EL-MOD., 4DO, DC 17.4V, 40MA
Potential separation			
Potential separation digital outputs			
• between the channels	No	No	No
• between the channels and backplane bus	Yes	Yes	Yes
• Between the channels and load voltage L+	Yes	Yes	Yes
Standards, approvals, certificates			
CE mark			Yes
Highest safety class achievable in safety mode			
• SIL acc. to IEC 61508	No		No
Use in hazardous areas			
• Type of protection acc. to EN 50020 (CENELEC)	II2 G (1) GD Ex ib[ia] IIC T4 and I M2 Ex ib[ia] I	II2 G (1) GD Ex ib[ia] IIC T4 and I M2 Ex ib[ia] I	II2 G (1) GD Ex ib[ia] IIC T4 and I M2 Ex ib[ia] I
• Type of protection acc. to KEMA	04 ATEX 1249	04 ATEX 1249	04 ATEX 1249
Dimensions			
Width	30 mm	30 mm	30 mm
Height	129 mm	129 mm	129 mm
Depth	136.5 mm	136.5 mm	136.5 mm
Weights			
Weight, approx.	255 g	255 g	255 g

Article number	6ES7132-7GD00-0AB0	6ES7132-7GD10-0AB0	6ES7132-7GD21-0AB0	6ES7132-7GD30-0AB0
	ET200iSP, EL-MOD., 4DO, DC 23,1V, 20MA	ET200iSP, EL-MOD., 4DO, DC 17,4V, 27MA	ET200iSP, EL-MOD., 4DO, DC 17,4V, 40MA	ET200iSP, EL-MOD., 4DO, DC 25.5V, 22MA
Input current				
Current consumption, typ.	290 mA	260 mA	380 mA	380 mA
from load voltage L+ (without load), max.	340 mA; with actuator supply	300 mA; with actuator supply	400 mA	400 mA
from backplane bus 3.3 V DC, max.	10 mA	10 mA		
Digital outputs				
Number of digital outputs	4; additionally 1 intrinsically-safe input for L shutdown	4; additionally 1 intrinsically-safe input for L shutdown	4; additionally 1 intrinsically-safe input for L shutdown	4; additionally 1 intrinsically-safe input for L shutdown
Short-circuit protection	Yes	Yes	Yes	Yes
No-load voltage U _{ao} (DC)	23.1 V	17.4 V	17.4 V	25.5 V
Internal resistor R _i	275 Ω	150 Ω	167 Ω	260 Ω
Trend key points E				
• Voltage U _e (DC)	17.6 V	13.3 V	10.7 V	19.8 V
• Current I _e	20 mA	27 mA; 54 mA when outputs connected in parallel	40 mA	22 mA
Output current				
• for signal "1" rated value	0.02 A	0.027 A	0.04 A	0.022 A
Output delay with resistive load				
• "0" to "1", max.	2 ms	2 ms	2 ms	2 ms
• "1" to "0", max.	1.5 ms	1.5 ms	1.5 ms	1.5 ms
Parallel switching of two outputs				
• for uprating	No; for Ex reasons not possible; nor for predecessor	Yes	Yes	No
Switching frequency				
• with resistive load, max.	100 Hz	100 Hz	100 Hz	100 Hz
• with inductive load, max.	2 Hz	2 Hz	2 Hz	2 Hz
Cable length				
• shielded, max.	500 m	500 m	500 m	500 m
• unshielded, max.	500 m	500 m	500 m	500 m

Technical specifications (continued)

Article number	6ES7132-7GD00-0AB0	6ES7132-7GD10-0AB0	6ES7132-7GD21-0AB0	6ES7132-7GD30-0AB0
	ET200iSP, EL-MOD., 4DO, DC 23,1V, 20MA	ET200iSP, EL-MOD., 4DO, DC 17,4V, 27MA	ET200iSP, EL-MOD., 4DO, DC 17,4V, 40MA	ET200iSP, EL-MOD., 4DO, DC 25.5V, 22MA
Interrupts/diagnostics/status information				
Status indicator	Yes	Yes	Yes	Yes
Diagnostics function	Yes	Yes	Yes	Yes
Alarms				
• Diagnostic alarm	Yes; Parameterizable	Yes; Parameterizable	Yes; Parameterizable	Yes; Parameterizable
Diagnoses				
• Diagnostic information readable	Yes	Yes	Yes	Yes
• Wire-break	Yes; R > 10 kohms, I < 100 μ A	Yes; R > 10 kohms, I < 100 μ A	Yes; R > 10 kohms, I < 100 μ A	Yes; R > 10 kohms, I < 100 μ A
• Short-circuit	Yes; R < 80 Ohm (one output), R < 40 Ohm (outputs connected in parallel)	Yes; R < 800 ohms (one output), R < 40 ohms (outputs connected in parallel)	Yes; R < 80 Ohm (one output), R < 40 Ohm (outputs connected in parallel)	Yes; R < 80 ohms
Diagnostics indication LED				
• Group error SF (red)	Yes	Yes	Yes	Yes
• Status indicator digital output (green)	Yes	Yes	Yes; Per channel	Yes; Per channel
Ex(i) characteristics				
Maximum values for connecting terminals for gas group IIC				
• U _o (no-load voltage), max.			19.4 V	27.9 V
• I _o (short-circuit current), max.			118 mA	110 mA
• P _o (power output), max.			572 mW	764 mW
• C _o (permissible external capacity), max.			241 nF; For IIC, 1507 nF for IIB	81 nF; For IIC, 651 nF for IIB
• L _o (permissible external inductivity), max.			1.7 mH; For IIC, 10.4 mH for IIB	1.7 mH; For IIC, 11.5 mH for IIB
Potential separation				
Potential separation digital outputs				
• between the channels	No	No	No	No
• between the channels and backplane bus	Yes	Yes	Yes	Yes
• Between the channels and load voltage L+	Yes	Yes	Yes	Yes
Standards, approvals, certificates				
CE mark	Yes	Yes	Yes	Yes
Highest safety class achievable in safety mode				
• SIL acc. to IEC 61508	No	No	No	No
Use in hazardous areas				
• Type of protection acc. to EN 50020 (CENELEC)	II 2 G (1) GD Ex ib[ia] IIC T4 and I M2 Ex ib[ia] I	II 2 G (1) GD Ex ib[ia] IIC T4 and I M2 Ex ib[ia] I	II 2 G (1) GD and I M2 Ex ib[ia][iaD] IIC T4; Ex ib [ia] I	II 2 G (1) GD and I M2 Ex ib[ia][iaD] IIC T4; Ex ib [ia] I
• Type of protection acc. to KEMA	04 ATEX 1249	04 ATEX 1249	04 ATEX 1249	04 ATEX 1249
Dimensions				
Width	30 mm	30 mm	30 mm	30 mm
Height	129 mm	129 mm	129 mm	129 mm
Depth	136.5 mm	136.5 mm	136.5 mm	136.5 mm
Weights				
Weight, approx.	255 g	255 g	255 g	255 g

SIMATIC PCS 7 system hardware

Process I/O

SIMATIC ET 200iSP

Digital electronic modules

Technical specifications (continued)

Article number	6ES7193-7CA00-0AA0 ET200iSP, TERM.-MOD. TM-EM/EM60S F. EM	6ES7193-7CA10-0AA0 ET200iSP, TERM.-MOD. TM-EM/EM60C F. EM	6ES7193-7CA20-0AA0 ET200iSP, TERM.-MOD. TM-EM/EM60S F. EM
Standards, approvals, certificates			
CE mark	Yes	Yes	Yes
Use in hazardous areas			
• Type of protection acc. to EN 50020 (CENELEC)	see ET 200iSP system	see ET 200iSP system	No
• Test number KEMA	04 ATEX 2242	04 ATEX 2242	
Dimensions			
Width	60 mm	60 mm	60 mm
Height	190 mm	190 mm	190 mm
Depth	52 mm	52 mm	52 mm
Weights			
Weight, approx.	275 g	275 g	235 g

Article number	6ES7132-7HB00-0AB0 ET200iSP, RELAY-MOD., 2DO, UC60V, 2A
Input current	
Current consumption, typ.	100 mA
from load voltage L+ (without load), max.	120 mA
Digital outputs	
Number of digital outputs	2
Short-circuit protection	No
Output current	
• for signal "1" rated value	2 A
Output delay with resistive load	
• "0" to "1", max.	8 ms
• "1" to "0", max.	3 ms
Parallel switching of two outputs	
• for uprating	No
• for redundant control of a load	No
Switching frequency	
• with resistive load, max.	0.5 Hz; See data in manual
• with inductive load, max.	0.2 Hz; See data in manual
Relay outputs	
Switching capacity of contacts	
- with resistive load, up to 60 °C, max.	2 A; See data in manual
- Thermal continuous current, max.	2 A; See data in manual
Cable length	
• shielded, max.	500 m
• unshielded, max.	500 m
Interrupts/diagnostics/status information	
Status indicator	Yes
Alarms	No
Substitute values connectable	Yes
Alarms	
• Diagnostic alarm	Yes
• Hardware interrupt	No
Diagnoses	
• Diagnostic information readable	Yes
• Wire-break	No; Cannot be determined in contact power circuit
• Short-circuit	No; Cannot be determined in contact power circuit

Article number	6ES7132-7HB00-0AB0 ET200iSP, RELAY-MOD., 2DO, UC60V, 2A
Diagnostics indication LED	
• Group error SF (red)	Yes
• Status indicator digital output (green)	Yes; Per channel
Ex(i) characteristics	
Maximum values for connecting terminals for gas group IIC	
• U _o (no-load voltage), max.	60 V
• U _m (voltage at non-intrinsically safe connecting terminals), max.	250 V
Potential separation	
Potential separation digital outputs	
• between the channels	Yes
• between the channels and backplane bus	Yes
• Between the channels and load voltage L+	Yes; Channels and power bus
Standards, approvals, certificates	
CE mark	Yes
Highest safety class achievable in safety mode	
• SIL acc. to IEC 61508	No
Use in hazardous areas	
• Type of protection acc. to EN 50020 (CENELEC)	II 2 G and I M2 Ex eibmb IIC T4; Ex eibmb I
• Type of protection acc. to KEMA	07 ATEX 0180
Dimensions	
Width	30 mm
Height	129 mm
Depth	136.5 mm
Weights	
Weight, approx.	255 g

Overview



Analog input modules

- 4-channel analog input module AI 2 WIRE HART EEx i for current measurement in the range 4 to 20 mA, suitable for connection of 2-wire transmitters (with/without HART functionality)
 - Resolution 12 bit + sign
 - Max. load of transmitter 750 Ω
 - Short-circuit and wire break monitoring
- 4-channel analog input module AI 4 WIRE HART EEx i for current measurement in the range 0/4 to 20 mA, suitable for connection of 4-wire transmitters (with/without HART functionality)
 - Resolution 12 bit + sign
 - Max. load of transmitter 750 Ω
 - Wire break monitoring
- 4-channel analog input module AI RTD EEx i for resistance measurement and for temperature measurement by Pt100/Ni100 resistance thermometer
 - Resolution 15 bit + sign
 - 2, 3, or 4-wire connection possible
 - Resistance measurements 600 Ω absolute and 1 000 Ω absolute
 - Wire break monitoring
- 4-channel analog input module AI TC EEx i for thermoelectric EMF measurements and for temperature measurement by thermocouple, type B, E, N, J, K, L, S, R, T, U
 - Resolution 15 bit + sign
 - Internal temperature compensation possible using TC sensor module (included in scope of delivery of module)
 - External temperature compensation by means of a temperature value acquired at an analog module of the same ET 200iSP station
 - Wire break monitoring

Analog output modules

- 4-channel analog output module AO I HART EEx i for output of current signals in the range 0/4 to 20 mA to field devices (with/without HART functionality)
 - Resolution 14 bit
 - Parameterizable substitute value in case of CPU failure
 - Short-circuit and wire break monitoring

Extra functions

Temperature compensation

A TC sensor module for internal temperature compensation is provided with the 4 AI TC module, and is fitted on the corresponding terminals of the associated terminal module.

External temperature compensation is possible via a Pt100 on a 4 AI RTD module.

Design

- The analog electronics modules are installed on terminal modules which must be ordered separately:
 - TM-IM/EM60 terminal modules for one interface module and one watchdog, reserve or electronics module (for versions, see section Interface module)
 - TM-EM/EM60 terminal modules with two slots for watchdog module, reserve module or electronics module (except 2 DO relay), with blue screw-type or spring-loaded terminals for hazardous environments or with black screw-type terminals for non-hazardous environments
- The analog electronics modules are plugged as planned onto terminal modules using screw-type systems (TM-EM/EM60S) or spring-loaded systems (TM-EM/EM60C).
- Using a spare module plugged onto a terminal module TM-EM/EM60S or TM-EM/EM60C, you can reserve a slot for an analog electronics module or close a gap resulting from how the modules were placed. The spare module can be simply replaced by the envisaged electronics module at a later point in time.
- The mechanical coding of the terminal module which is carried out when an electronics module is plugged on for the first time prevents the connection of incorrect replacement modules.
- Hot swapping of individual modules is possible under hazardous conditions.
- The process signals are connected to the terminals of the terminal modules assigned according to the plan, using either conventional screw-type or spring-loaded systems (conductor cross-sections 0.14 mm² to max. 2.5 mm²) depending on the type of module.

SIMATIC PCS 7 system hardware

Process I/O

SIMATIC ET 200iSP

Analog electronic modules

Ordering data

Article No.

Analog input modules

Analog input modules EEx i

4 AI | 2 WIRE HART

For measuring currents with 2-wire transmitters with/without HART functionality

- 4 × 4 ... 20 mA, HART, 2-wire transmitter
- Transmitter load: max. 750 Ω
- Resolution 12 bit + sign
- Short-circuit monitoring
- Wire break monitoring

6ES7134-7TD00-0AB0

4 AI | 4 WIRE HART

For measuring currents with 4-wire transmitters with/without HART functionality

- 4 × 0/4 ... 20 mA, HART, 4-wire transmitter
- Transmitter load: max. 750 Ω
- Resolution 12 bit + sign
- Wire break monitoring

6ES7134-7TD50-0AB0

4 AI RTD

For measuring resistances as well as for temperature measurements with resistance thermometers

- 4 × RTD, resistance thermometer Pt100/Ni100
- 2, 3, 4-wire
- Resolution 15 bit + sign
- Short-circuit monitoring
- Wire break monitoring

6ES7134-7SD51-0AB0

4 AI TC

For thermoelectric EMF measurements as well as for temperature measurements with thermocouples

- 4 × TC (thermocouples)
- Type B [PtRh-PtRh]
- Type N [NiCrSi-NiSi]
- Type E [NiCr-CuNi]
- Type R [PtRh-Pt]
- Type S [PtPh-Pt]
- Type J [Fe-CuNi]
- Type L [Fe-CuNi]
- Type T [Cu-CuNi]
- Type K [NiCr-Ni]
- Type U [Cu-CuNi]
- Resolution 15 bit + sign
- Internal compensation of reference junction temperature possible using TC sensor module (included in scope of supply of module)
- External temperature compensation via Pt100, connected to RTD module of same ET 200iSP station
- Wire break monitoring

6ES7134-7SD00-0AB0

Analog output modules

Analog output modules EEx i

4 AO I HART

For output of currents to field devices with/without HART functionality

- 4 × 0/4 ... 20 mA, HART (max. load 750 Ω)
- Resolution 14-bit
- Short-circuit monitoring
- Wire break monitoring
- Parameterizable substitute value in case of CPU failure

6ES7135-7TD00-0AB0

Article No.

Terminal modules

ET 200iSP terminal module TM-EM/EM60

For two modules (reserve module, watchdog module and all electronic modules except 2 DQ relays can be plugged in)

- For hazardous environments
 - TM-EM/EM60S (blue screw-type terminals)
 - TM-EM/EM60C (blue spring-loaded terminals)
- For non-hazardous environments
 - TM-EM/EM60S (black screw-type terminals)

6ES7193-7CA00-0AA0

6ES7193-7CA10-0AA0

6ES7193-7CA20-0AA0

Accessories

Reserve module

For any electronic module

6ES7138-7AA00-0AA0

Labeling sheet

DIN A4, perforated, each consisting of 10 sheets of 30 strips each for electronic modules and 20 strips each for IM 151

- petrol
- yellow

6ES7193-7BH00-0AA0

6ES7193-7BB00-0AA0

Labels, inscribed

For slot numbering, label size H × W (in mm): 5 × 7

- 204 labels, for slots 1 to 20
- 204 labels, for slots 1 to 40

8WA8361-0AB

8WA8361-0AC

Labels, blank

136 labels for slot numbering, label size H × W (in mm): 5 × 7

8WA8348-2AY

S7-300 mounting rails

- 585 mm long, suitable for assembly of ET 200iSP in a 650 mm wide wall box
- 885 mm long, suitable for assembly of ET 200iSP in a 950 mm wide wall box

6ES7390-1AF85-0AA0

6ES7390-1AJ85-0AA0

Technical specifications

Article number	6ES7134-7SD00-0AB0 ET200iSP, EL-MOD., 4 AI TC	6ES7134-7SD51-0AB0 ET200iSP, EL-MOD., 4 AI RTD, PT100/Ni100	6ES7134-7TD00-0AB0 ET200iSP, EL-MOD., 4 AI, HART, 2-WIRE	6ES7134-7TD50-0AB0 ET200iSP, EL-MOD., 4 AI, HART, 4-WIRE
Input current				
Current consumption, typ.	17 mA	19 mA	280 mA	27 mA
from supply voltage L+, max.	30 mA	22 mA	320 mA	30 mA
Output voltage				
Power supply to the transmitters				
• short-circuit proof			Yes	
• Supply current, max.			23 mA; per channel	
Analog inputs				
Number of analog inputs	4	4	4	4
permissible input current for current input (destruction limit), max.			90 mA	50 mA
Cycle time (all channels) max.	320 ms; 66 ms basic conversion time x 4 channels with interference frequency suppression 60 Hz, 80 ms basic conversion time x 4 channels with interference frequency suppression 50 Hz	320 ms; 66 ms basic conversion time x 4 channels with interference frequency suppression 60 Hz, 80 ms basic conversion time x 4 channels with interference frequency suppression 50 Hz	120 ms; 30 ms basic conversion time x4 channels with 60 Hz, 50 Hz interference frequency suppression	120 ms; 30 ms basic conversion time x4 channels with 60 Hz, 50 Hz interference frequency suppression
Technical unit for temperature measurement adjustable	Yes	Yes	Yes	Yes
Input ranges (rated values), voltages				
• -80 mV to +80 mV	Yes			
Input ranges (rated values), currents				
• 4 mA to 20 mA			Yes	Yes
Input ranges (rated values), thermocouples				
• Type B	Yes			
• Type C	Yes			
• Type E	Yes			
• Type J	Yes			
• Type K	Yes			
• Type L	Yes			
• Type N	Yes			
• Type R	Yes			
• Type S	Yes			
• Type T	Yes			
• Type U	Yes			
Input ranges (rated values), resistance thermometer				
• Ni 100		Yes		
• Pt 100		Yes		
Input ranges (rated values), resistors				
• 0 to 600 ohms		Yes; also 1 000 ohms		
Thermocouple (TC)				
Temperature compensation				
- internal temperature compensation	Yes; via supplied TC sensor module			
- external temperature compensation with compensations socket	Yes; via temperature value, acquired by an analog module of the same ET 200iSP station			
Characteristic linearization				
• parameterizable	Yes	Yes		
- for thermocouples	Yes			
- for resistance thermometer		Yes		
Cable length				
• shielded, max.	50 m	500 m	500 m	500 m

SIMATIC PCS 7 system hardware

Process I/O

SIMATIC ET 200iSP

Analog electronic modules

Technical specifications (continued)

Article number	6ES7134-7SD00-0AB0 ET200iSP, EL-MOD., 4 AI TC	6ES7134-7SD51-0AB0 ET200iSP, EL-MOD., 4 AI RTD, PT100/Ni100	6ES7134-7TD00-0AB0 ET200iSP, EL-MOD., 4 AI, HART, 2-WIRE	6ES7134-7TD50-0AB0 ET200iSP, EL-MOD., 4 AI, HART, 4-WIRE
Analog value generation for the inputs				
Measurement principle	integrating (Sigma-Delta)	integrating (Sigma-Delta)	integrating (Sigma-Delta)	integrating (Sigma-Delta)
Integration and conversion time/resolution per channel				
• Resolution with overrange (bit including sign), max.	16 bit	16 bit	13 bit	12 bit; + sign
• Integration time, parameterizable	Yes	Yes	No	Yes
• Basic conversion time, including integration time (ms)	80 ms at 50 Hz; 66 ms at 60 Hz	80 ms at 50 Hz; 66 ms at 60 Hz		
Smoothing of measured values				
• parameterizable	Yes; in 4 stages	Yes; in 4 stages	Yes; in 4 stages	Yes; in 4 stages
Encoder				
Connection of signal encoders				
• for current measurement as 2-wire transducer - Burden of 2-wire transmitter, max.			Yes 750 Ω	
• for current measurement as 4-wire transducer				Yes
• for resistance measurement with two-wire connection		Yes		
• for resistance measurement with three-wire connection		Yes		
• for resistance measurement with four-wire connection		Yes		
Errors/accuracies				
Linearity error (relative to input range), (+/-)	0.015 %	0.015 %	0.015 %	0.015 %
Temperature error (relative to input range), (+/-)	0.02 %/K	0.02 %/K	0.005 %/K	0.005 %/K
Crosstalk between the inputs, min.	-50 dB	-50 dB	-50 dB	-50 dB
Repeat accuracy in steady state at 25 °C (relative to input range), (+/-)	0.01 %	0.01 %	0.01 %	0.01 %
Operational error limit in overall temperature range				
• Voltage, relative to input range, (+/-)	0.15 %		0.15 %	0.15 %
• Current, relative to input range, (+/-)				
• Resistance thermometer, relative to input range, (+/-)		0.15 %; Applies to resistances standard ±0.8 K, climatic ±0.3 K		
Basic error limit (operational limit at 25 °C)				
• Voltage, relative to input range, (+/-)	0.1 %		0.1 %	0.1 %
• Current, relative to input range, (+/-)				
• Resistance thermometer, relative to input range, (+/-)		0.1 %; Applies to resistances standard ±0.5 K, climatic ±0.2 K		
Interference voltage suppression for $f = n \times (f_1 \pm 1 \%)$, $f_1 =$ interference frequency				
• Series mode interference (peak value of interference < rated value of input range), min.	70 dB	70 dB	70 dB	70 dB
• Common mode interference, min.	90 dB	90 dB		

Technical specifications (continued)

Article number	6ES7134-7SD00-0AB0 ET200iSP, EL-MOD., 4 AI TC	6ES7134-7SD51-0AB0 ET200iSP, EL-MOD., 4 AI RTD, PT100/Ni100	6ES7134-7TD00-0AB0 ET200iSP, EL-MOD., 4 AI, HART, 2-WIRE	6ES7134-7TD50-0AB0 ET200iSP, EL-MOD., 4 AI, HART, 4-WIRE
Interrupts/diagnostics/ status information				
Alarms				
• Diagnostic alarm	Yes; Parameterizable	Yes	Yes; Parameterizable	Yes; Parameterizable
• Limit value alarm	Yes; Parameterizable	Yes	Yes; Parameterizable	Yes; Parameterizable
Diagnoses				
• Diagnostic information readable	Yes	Yes	Yes	Yes
• Wire-break		Yes	Yes	Yes
• Short-circuit		Yes	Yes	
• Group error		Yes		
Diagnostics indication LED				
• Group error SF (red)	Yes	Yes	Yes	Yes
Potential separation				
Potential separation analog inputs				
• between the channels	Yes; Functional	No	No	No
• between the channels and backplane bus	Yes	Yes	Yes	Yes
• Between the channels and load voltage L+		Yes; Channels and power bus		
Standards, approvals, certificates				
CE mark	Yes	Yes	Yes	Yes
Highest safety class achievable in safety mode				
• Performance level according to ISO 13849-1	none	none	none	none
• SIL acc. to IEC 61508	No	No	No	No
Use in hazardous areas				
• Type of protection acc. to EN 50020 (CENELEC)	II2 G (1) GD Ex ib[ia] IIC T4 and I M2 Ex ib[ia] I	II2 G (1) GD Ex ib[ia] IIC T4 and I M2 Ex ib[ia] I	II2 G (1) GD Ex ib[ia] IIC T4 and I M2 Ex ib[ia] I	II2 G (1) GD Ex ib[ia] IIC T4 and I M2 Ex ib[ia] I
• Type of protection acc. to KEMA	04 ATEX 1246	04 ATEX 1247	04 ATEX 1244	04 ATEX 1245
Dimensions				
Width	30 mm	30 mm	30 mm	30 mm
Height	129 mm	129 mm	129 mm	129 mm
Depth	136.5 mm	136.5 mm	136.5 mm	136.5 mm
Weights				
Weight, approx.	230 g	230 g	230 g	230 g

SIMATIC PCS 7 system hardware

Process I/O

SIMATIC ET 200iSP

Analog electronic modules

Technical specifications (continued)

Article number	6ES7135-7TD00-0AB0 ET200iSP, EL-MOD., 4 AO, 4-20MA, HART
Input current	
Current consumption, typ.	295 mA
from load voltage L+ (without load), max.	330 mA
Analog outputs	
Number of analog outputs	4
Cycle time (all channels) max.	3.6 ms
Output ranges, current	
• 0 to 20 mA	Yes
• 4 mA to 20 mA	Yes
Connection of actuators	
• for current output two-wire connection	Yes
Load impedance (in rated range of output)	
• with current outputs, max.	750 Ω
Cable length	
• shielded, max.	500 m
Analog value generation for the outputs	
Integration and conversion time/resolution per channel	
• Resolution with overrange (bit including sign), max.	14 bit
Settling time	
• for resistive load	4 ms
• for capacitive load	40 ms
• for inductive load	40 ms
Errors/accuracies	
Linearity error (relative to output range), (+/-)	0.015 %
Temperature error (relative to output range), (+/-)	0.005 %/K
Crosstalk between the outputs, min.	-50 dB
Repeat accuracy in steady state at 25 °C (relative to output range), (+/-)	0.01 %
Operational error limit in overall temperature range	
• Current, relative to output range, (+/-)	0.15 %
Basic error limit (operational limit at 25 °C)	
• Current, relative to output range, (+/-)	0.1 %

Article number	6ES7135-7TD00-0AB0 ET200iSP, EL-MOD., 4 AO, 4-20MA, HART
Interrupts/diagnostics/status information	
Substitute values connectable	Yes
Alarms	
• Diagnostic alarm	Yes
Diagnoses	
• Diagnostic information readable	Yes
• Wire-break	Yes
• Short-circuit	Yes
Diagnostics indication LED	
• Group error SF (red)	Yes
Potential separation	
Potential separation analog outputs	
• between the channels	No
• between the channels and backplane bus	Yes
Standards, approvals, certificates	
CE mark	Yes
Use in hazardous areas	
• Type of protection acc. to EN 50020 (CENELEC)	I/2 G (1) GD Ex ib[ia] IIC T4 and I M2 Ex ib[ia] I
• Type of protection acc. to KEMA	04 ATEX 1250
Dimensions	
Width	30 mm
Height	129 mm
Depth	136.5 mm
Weights	
Weight, approx.	265 g

Overview



The electronic modules of the SIMATIC ET 200iSP distributed I/O-system equipped with safety functions can be used together with the safety-related automation systems (controllers) for the implementation of safety applications. The input modules record the process signals, evaluate them, and prepare them for additional processing by the automation system. The output modules convert the safety-related signals output by the automation systems so that they are suitable for controlling the connected actuators.

F digital input modules

- 8 F-DI Ex NAMUR
Safety-related digital input module for evaluating the signals from IEC 60947-5-6/NAMUR sensors and connected/non-connected mechanical contacts in hazardous and non-hazardous areas
 - SIL3/Cat.3/PLe with 8 inputs (1-channel/1oo1 evaluation) or 4 inputs (2-channel/1oo2 evaluation)
 - 8 short-circuit-proof sensor supplies (8 V DC) for 1 channel each
 - Inputs and sensor supplies electrically isolated from power bus and backplane bus
 - Diagnostics evaluation (deactivated for non-connected mechanical contacts)
 - Internal diagnostics buffer
 - Programmable diagnostics interrupt
 - Supports time stamping
 - Channel-selective passivation
 - Firmware update using HW Config possible
 - Exclusively for safety mode
 - LED displays for safety mode, group errors and channel status/fault

F digital output modules

- 4 F-DO Ex DC 17.4 V/40 mA
Safety-related digital output module for controlling actuators in hazardous and non-hazardous areas, e.g. solenoid valves, DC current relays or indicator lamps
 - SIL3/Cat.3/PLe with 4 outputs, P/P-switching
 - Electrical isolation from power bus and backplane bus
 - Rated load voltage 17.4 V DC
 - Max. output current 40 mA
 - Performance enhancement through parallel connection of two digital outputs for one actuator
 - Short-circuit, overload and wire-break monitoring
 - Configurable diagnostics
 - Internal diagnostics buffer
 - Programmable diagnostics interrupt
 - Channel-selective passivation
 - Firmware update using HW Config possible
 - Exclusively for safety mode
 - LED displays for safety mode, group errors and channel status/fault

F analog input modules

- 4 F-AI Ex HART (0 ... 20 mA or 4 ... 20 mA)
Safety-related digital input module for evaluating the signals from current sensors in hazardous and non-hazardous areas, e.g. 2-wire transmitters and HART field devices
 - SIL3/Cat.3/PLe with 4 inputs of one module (1-channel/1oo1 evaluation) or 4 inputs of two modules (2-channel/1oo2 evaluation)
 - Measuring ranges: 0 ... 20 mA or 4 ... 20 mA
 - Resolution 15 bit + sign
 - HART communication in measuring range 4 ... 20 mA
 - 4 short-circuit-proof sensor supplies (min. 12 V DC; max. 26 V DC) for 1 channel each
 - Inputs and sensor supplies electrically isolated from backplane bus
 - Configurable diagnostics
 - Programmable diagnostics interrupt
 - Internal diagnostics buffer
 - Firmware update using HW Config possible
 - Exclusively for safety mode
 - LED displays for safety mode, group errors, channel faults and HART status per channel

Design

- The safety-related electronics modules are mounted on terminal modules that are ordered separately:
 - TM-IM/EM60 terminal modules for one interface module and one watchdog, reserve or electronics module (for versions, see section "Interface module")
 - TM-EM/EM60 terminal modules with two slots for watchdog module, reserve module or electronics module (except 2 DO relay), with blue screw-type or spring-loaded terminals for hazardous environments or with black screw-type terminals for non-hazardous environments
- The safety-related electronics modules are plugged as planned onto terminal modules using screw-type systems (TM-EM/EM60S) or spring-loaded systems (TM-EM/EM60C).
- Using a spare module plugged onto a terminal module TM-EM/EM60S or TM-EM/EM60C, you can reserve a slot for an safety-related electronics module or close a gap resulting from the design. The spare module can be simply replaced by the envisaged electronics module at a later point in time.
- The mechanical coding of the terminal module which is carried out when an electronics module is plugged on for the first time prevents the connection of incorrect replacement modules.
- Hot swapping of individual modules is possible under hazardous conditions.
- The process signals are connected to the terminals of the terminal modules assigned according to the plan, using either conventional screw-type or spring-loaded systems (conductor cross-sections 0.14 mm² to max. 2.5 mm²) depending on the type of module.

SIMATIC PCS 7 system hardware

Process I/O

SIMATIC ET 200iSP

Safety-related electronic modules

Ordering data	Article No.	Ordering data	Article No.
Safety-related electronics modules		Accessories	
F digital input modules		Reserve module For any electronics module	6ES7138-7AA00-0AA0
8 F-DI Ex NAMUR For evaluating the signals from IEC 60947-5-6/NAMUR sensors and connected/non-connected mechanical contacts in hazardous and non-hazardous areas • SIL3/Cat.3/PLe with 8 inputs (1-channel/1oo1 evaluation) or 4 inputs (2-channel/1oo2 evaluation)	6ES7138-7FN00-0AB0	Labeling sheet DIN A4, perforated, each consisting of 10 sheets of 30 strips each for electronics modules and 20 strips each for IM 151 • petrol • yellow	6ES7193-7BH00-0AA0 6ES7193-7BB00-0AA0
F digital output modules		Labels, inscribed For slot numbering, label size H × W (in mm): 5 × 7 • 204 labels, for slots 1 to 20 • 204 labels, for slots 1 to 40	8WA8361-0AB 8WA8361-0AC
4 F-DO Ex 17.4 V DC/40 mA For controlling actuators in hazardous and non-hazardous areas, e.g. solenoid valves, DC current relays or indicator lamps • SIL3/Cat.3/PLe with 4 outputs, P/P-switching	6ES7138-7FD00-0AB0	Labels, blank 136 labels for slot numbering, label size H × W (in mm): 5 × 7	8WA8348-2AY
F analog input modules		S7-300 mounting rails • 585 mm long, suitable for assembly of ET 200iSP in a 650 mm wide wall box • 885 mm long, suitable for assembly of ET 200iSP in a 950 mm wide wall box	6ES7390-1AF85-0AA0 6ES7390-1AJ85-0AA0
4 F-AI Ex HART (0 ... 20 mA or 4 ... 20 mA) For evaluating the signals from current sensors in hazardous and non-hazardous areas, e.g. 2-wire transmitters and HART field devices • SIL3/Cat.3/PLe with 4 inputs of one module (1-channel/1oo1 evaluation) or 4 inputs of two modules (2-channel/1oo2 evaluation) • Resolution 15 bit + sign • HART communication in measuring range 4 ... 20 mA	6ES7138-7FA00-0AB0		
Terminal modules			
ET 200iSP terminal module TM-EM/EM60 For two modules (reserve module, watchdog module and all electronics modules except 2 DO Relay can be plugged in) • For hazardous environments - TM-EM/EM60S (blue screw-type terminals) - TM-EM/EM60C (blue spring-loaded terminals) • For non-hazardous environments - TM-EM/EM60S (black screw-type terminals)	6ES7193-7CA00-0AA0 6ES7193-7CA10-0AA0 6ES7193-7CA20-0AA0		

Technical specifications

Article number	6ES7138-7FN00-0AB0 ET200iSP, 8F-DI NAMUR EX, FAILSAFE
Input current	
Current consumption, typ. from supply voltage L+, max.	145 mA 150 mA; int. Powerbus
Encoder supply	
Number of outputs	8
Type of output voltage	8 V DC
Digital inputs	
Number of digital inputs	8
Number of NAMUR inputs	8
Input current	
• for signal "0", max. (permissible quiescent current)	1.2 mA
• for signal "1", min.	2.1 mA
• for signal "1", typ.	9.5 mA
Encoder	
Number of connectable encoders, max.	8
Connectable encoders	
• NAMUR encoder	Yes
Interrupts/diagnostics/ status information	
Status indicator	Yes
Diagnostics function	Yes
Alarms	
• Diagnostic alarm	Yes; Parameterizable
• Hardware interrupt	No
Diagnoses	
• Diagnostic information readable	Yes
• Wire-break	Yes; NAMUR encoders or single contact with 10 kOhm parallel resistor
• Short-circuit	Yes; R load < 150 ohms with NAMUR sensor/sensor and NAMUR changeover contact/sensor to DIN 19234
Diagnostics indication LED	
• Group error SF (red)	Yes
Potential separation	
Potential separation digital inputs	
• between the channels	No
• between the channels and backplane bus	Yes
Standards, approvals, certificates	
CE mark	Yes
Highest safety class achievable in safety mode	
• Performance level according to ISO 13849-1	PLe
• SIL acc. to IEC 61508	SIL 3
Use in hazardous areas	
• Type of protection acc. to EN 50020 (CENELEC)	II 2 G (1) GD Ex ib[ia Ga][ia IIIC Da] IIC T4 GB and I M2 Ex ib[ia Ma] I Mb
• Type of protection acc. to KEMA	10 ATEX 0056
Dimensions	
Width	30 mm
Height	129 mm
Depth	136.5 mm
Weights	
Weight, approx.	288 g

Article number	6ES7138-7FD00-0AB0 ET200iSP, 4F-DO 40MA EX, FAILSAFE
Input current	
Current consumption, typ. from load voltage L+ (without load), max.	340 mA 510 mA; int. Powerbus
Digital outputs	
Number of digital outputs	4
Short-circuit protection	Yes
Controlling a digital input	No
No-load voltage U _{ao} (DC)	17.4 V
Internal resistor R _i	167 Ω
Load resistance range	
• lower limit	270 Ω
• upper limit	18 kΩ
Trend key points E	
• Voltage U _e (DC)	10.7 V
• Current I _e	40 mA
Output voltage	
• for signal "1", max.	17.4 V
Output current	
• for signal "0" residual current, max.	10 μA
Parallel switching of two outputs	
• for uprating	Yes
• for redundant control of a load	No
Switching frequency	
• with resistive load, max.	30 Hz
• with inductive load, max.	2 Hz
Cable length	
• shielded, max.	500 m
• unshielded, max.	500 m
Interrupts/diagnostics/ status information	
Status indicator	Yes
Substitute values connectable	Yes
Alarms	
• Diagnostic alarm	Yes; Parameterizable
Diagnoses	
• Diagnostic information readable	Yes
• Wire-break	Yes
• Short-circuit	Yes
Diagnostics indication LED	
• Group error SF (red)	Yes
• Status indicator digital output (green)	Yes
Potential separation	
Potential separation digital outputs	
• between the channels	No
• between the channels and backplane bus	Yes
• Between the channels and load voltage L+	Yes

SIMATIC PCS 7 system hardware

Process I/O

SIMATIC ET 200iSP

Safety-related electronic modules

Technical specifications (continued)

Article number	6ES7138-7FD00-0AB0 ET200iSP, 4F-DO 40MA EX, FAILSAFE
Standards, approvals, certificates	
CE mark	Yes
Highest safety class achievable in safety mode	
• Performance level according to ISO 13849-1	PLe
• SIL acc. to IEC 61508	SIL 3
Use in hazardous areas	
• Type of protection acc. to EN 50020 (CENELEC)	II 2 G (1) GD Ex ib[ja Ga][ia IIC Da] IIC T4 GB and I M2 Ex ib[ja Ma] I Mb
• Type of protection acc. to KEMA	10 ATEX 0057
Dimensions	
Width	30 mm
Height	129 mm
Depth	136.5 mm
Weights	
Weight, approx.	285 g
Article number	6ES7138-7FA00-0AB0 ET200iSP, 4F-AI HART EX, FAILSAFE
Input current	
Current consumption, typ. from supply voltage L+, max.	315 mA 490 mA; int. Powerbus
Output voltage	
Power supply to the transmitters	
• short-circuit proof	Yes
• Supply current, max.	25 mA; Plus 4 mA per channel
Analog inputs	
Number of analog inputs	4
Cycle time (all channels) max.	See data in manual
Input ranges (rated values), currents	
• 0 to 20 mA	Yes
• 4 mA to 20 mA	Yes
Cable length	
• shielded, max.	500 m
Analog value generation for the inputs	
Measurement principle	integrating (Sigma-Delta)
Integration and conversion time/resolution per channel	
• Resolution with overrange (bit including sign), max.	16 bit
• Integration time, parameterizable	Yes
Smoothing of measured values	
• parameterizable	Yes; in 4 stages
Encoder	
Connection of signal encoders	
• for current measurement as 2-wire transducer	Yes
- Burden of 2-wire transmitter, max.	750 Ω

Article number	6ES7138-7FA00-0AB0 ET200iSP, 4F-AI HART EX, FAILSAFE
Errors/accuracies	
Linearity error (relative to input range), (+/-)	0.015 %
Temperature error (relative to input range), (+/-)	0.005 %/K
Crosstalk between the inputs, min.	-50 dB
Repeat accuracy in steady state at 25 °C (relative to input range), (+/-)	0.015 %
Operational error limit in overall temperature range	
• Current, relative to input range, (+/-)	0.35 %
Basic error limit (operational limit at 25 °C)	
• Current, relative to input range, (+/-)	0.1 %
Interference voltage suppression for $f = n \times (f_1 \pm 1 \%)$, $f_1 = \text{interference frequency}$	
• Series mode interference (peak value of interference < rated value of input range), min.	40 dB
• Common mode interference, min.	50 dB
Interrupts/diagnostics/status information	
Alarms	
• Diagnostic alarm	Yes; Parameterizable
Diagnoses	
• Diagnostic information readable	Yes
• Wire-break	Yes
• Short-circuit	Yes
Diagnostics indication LED	
• Group error SF (red)	Yes
Potential separation	
Potential separation analog inputs	
• between the channels	No
• between the channels and backplane bus	Yes
• Between the channels and load voltage L+	Yes; Power bus
Standards, approvals, certificates	
CE mark	Yes
Highest safety class achievable in safety mode	
• Performance level according to ISO 13849-1	PLe
• SIL acc. to IEC 61508	SIL 3
Use in hazardous areas	
• Type of protection acc. to EN 50020 (CENELEC)	II 2 G (1) GD Ex ib[ja Ga][ia IIC Da] IIC T4 GB and I M2 Ex ib[ja Ma] I Mb
• Type of protection acc. to KEMA	10 ATEX 0058
Dimensions	
Width	30 mm
Height	129 mm
Depth	136.5 mm
Weights	
Weight, approx.	299 g

Overview



The watchdog module has two fundamental functions:

- Monitoring of the ET 200iSP remote I/O station for hardware failures (hardware lifebeat); external, applicative failure monitoring is also possible via an I/O address area of the module
- Intrinsically-safe power supply for external actuator switch-off

The watchdog module must be plugged onto a terminal module (order separately). The following terminal modules are suitable for this:

- TM-IM/EM60 terminal modules for one interface module and one watchdog, reserve or electronics module (for versions, see Interface module section)
- TM-EM/EM60 terminal modules with two slots for watchdog module, reserve module or electronics modules (except 2 DO relay):
 - with blue screw-type or spring-loaded terminals for hazardous environments
 - with black screw-type terminals for non-hazardous environments

The first slot directly next to the interface module is provided for the watchdog module.

Ordering data

Article No.

Watchdog module

Watchdog module

For failure monitoring and for the intrinsically-safe power supply of an external actuator switch-off

6ES7138-7BB00-0AB0

Terminal modules

ET 200iSP terminal module**TM-EM/EM60**

For two modules (reserve module, watchdog module and all electronics modules except 2 DO Relay can be plugged in)

- For hazardous environments
 - TM-EM/EM60S (blue screw-type terminals)
 - TM-EM/EM60C (blue spring-loaded terminals)
- For non-hazardous environments
 - TM-EM/EM60S (black screw-type terminals)

6ES7193-7CA00-0AA0

6ES7193-7CA10-0AA0

6ES7193-7CA20-0AA0

Accessories

Labeling sheet

DIN A4, perforated, each consisting of 10 sheets of 30 strips each for electronics modules and 20 strips each for IM 151

- petrol
- yellow

6ES7193-7BH00-0AA0

6ES7193-7BB00-0AA0

Labels, inscribed

for slot numbering, label size H x W (in mm): 5 x 7

- 204 labels, for slots 1 to 20
- 204 labels, for slots 1 to 40

8WA8361-0AB

8WA8361-0AC

Labels, blank

136 labels for slot numbering, label size H x W (in mm): 5 x 7

8WA8348-2AY

Technical specifications

Article number	6ES7138-7BB00-0AB0 ET 200iSP, WATCHDOG MOD.
Digital inputs	
Number of digital inputs	0
Dimensions	
Width	30 mm
Height	129 mm
Depth	136.5 mm

SIMATIC PCS 7 system hardware

Process I/O

SIMATIC ET 200iSP

RS 485-iS coupler

Overview



Tasks of the RS 485-iS coupler

- Conversion of the electrical PROFIBUS DP RS 485 transmission technology into the intrinsically-safe RS 485-iS transmission technology with a transmission rate of 1.5 Mbps
- Required to connect intrinsically-safe PROFIBUS DP stations, e.g. ET 200iSP or devices from other vendors with Ex i DP connection
- Acts as a safety barrier
- Additional use as a repeater in the hazardous area
- Passive bus station (no configuration necessary)
- Certified according to ATEX 100a

Design

- The RS 485-iS coupler is an open unit; assembly is only permissible in enclosures, cabinets or rooms for electrical equipment.
- The RS 485-iS coupler is approved for use in Zone 2 hazardous areas. For this purpose, it must be fitted in an enclosure complying at least with degree of protection IP54. A manufacturer's declaration for zone 2 (according to EN 50021) is required for the enclosure and the necessary cable glands.
- The RS 485-iS coupler can be used in a horizontal or vertical position.
- Installation is on a SIMATIC S7-300 rail.
- Diagnostics LEDs on the front panel signal the operating status.

Connection to PROFIBUS DP

- Connection to standard PROFIBUS DP via standard Sub-D socket (at the bottom on the RS 485-iS coupler, behind the right front door).

Integrated bus connection for PROFIBUS DP with RS 485-iS transmission technology

- Connection of PROFIBUS DP with RS 485-iS transmission technology via screw terminals (at the top of the RS 485-iS coupler, behind the right front door)
- The last bus node on the intrinsically safe PROFIBUS DP segment (not further RS 485-iS couplers) must be terminated by a selectable terminating resistor using the connector, article number 6ES7972-0DA60-0XA0.

Ordering data

Article No.

RS 485-iS coupler

Isolating transformer for connection of PROFIBUS DP segments with RS 485 and RS 485-iS transmission systems

6ES7972-0AC80-0XA0

Accessories

PROFIBUS connector with selectable terminating resistor

For connection of IM 152 to PROFIBUS DP with RS 485-iS transmission technology

6ES7972-0DA60-0XA0

S7-300 rails

Lengths:

- 160 mm
- 482 mm
- 530 mm
- 830 mm
- 2 000 mm

6ES7390-1AB60-0AA0

6ES7390-1AE80-0AA0

6ES7390-1AF30-0AA0

6ES7390-1AJ30-0AA0

6ES7390-1BC00-0AA0

PROFIBUS FastConnect Standard Cable, violet

Standard type with special design for fast mounting, 2-wire, shielded, cut-to-length

Specify length in m

Max. delivery unit 1 000 m, minimum order quantity 20 m

6XV1830-0EH10

Preferred lengths

- 20 m
- 50 m
- 100 m
- 200 m
- 500 m
- 1 000 m

6XV1830-0EN20

6XV1830-0EN50

6XV1830-0ET10

6XV1830-0ET20

6XV1830-0ET50

6XV1830-0EU10

PROFIBUS FastConnect Standard Cable IS GP, blue

Cable type for use in potentially explosive atmospheres, with special design for fast mounting, 2-wire, shielded, cut-to-length

Specify length in m

Max. delivery unit 1 000 m, minimum order quantity 20 m

6XV1831-2A

Technical specifications

Technical specifications - RS 485-iS coupler	
Dimensions and weight	
Dimensions W x H x D (mm)	80 x 125 x 130
Weight	Approx. 500 g
Technical data - General	
Degree of protection	IP20
Ambient temperature	- 20 ... + 60 °C
Standards and approvals	
• PROFIBUS	IEC 61784-1:2002 Ed1 CP 3/1 94/9/EG (ATEX 100a)
• EU directive	II 3 (2) G EEx nA[ib] IIC T4
• CENELEC	Class I, Division2, Group A, B, C, D T4 Class I Zone 2, Group IIC T4
• UL and CSA	AIS Class I, Divison 1, Group A, B, C, D [Aexib] IIC, Class I, Zone1, 2, Group IIC
• FM	Class I, Division2, Group A, B, C, D T4 Class I Zone 2, Group IIC T4 AIS Class I, Divison 1, Group A, B, C, D [Aexib] IIC, Class I, Zone1, 2, Group IIC
• IEC	IEC61131-2, Part 2
• CE	Conforming with 89/336/EWG Conforming with 73/23/EWG
• Ship-building certification	Classification companies <ul style="list-style-type: none"> • ABS (American Bureau of Shipping) • BV (Bureau Veritas) • DNV (Det Norske Veritas) • GL (Germanischer Lloyd) • LRD (Lloyds Register of Shipping) • Class NK (Nippon Kaiji Kyokai)
Module-Specific Specifications	
Transmission rate on PROFIBUS DP, PROFIBUS RS 485-iS	9.6; 19.2; 45.45; 93.75; 187.5; 500 kbps 1.5 Mbps
Bus-Protocol	PROFIBUS DP
Voltages, Currents, Potentials	
Rated supply voltage of RS 485-iS coupler	24 V DC (20.4 ... 28.8 V)
• Polarity reversal protection	Yes
• Voltage drop bypass	Min. 5 ms
Electrical isolation of 24 V power supply	
• to PROFIBUS DP	Yes
- tested with	500 V DC
• to PROFIBUS RS 485-iS	Yes
- tested with	AC 500 V
Current consumption RS 485-iS coupler (24 V DC), max.	150 mA
Power loss of the module, typically	3 Watts

Technical specifications - RS 485-iS coupler		
Status, alarms, diagnostics		
Status display	no	
Alarms	None	
Diagnostic functions	Yes	
• Bus monitoring PROFIBUS DP (primary)	Yellow LED "DP1"	
• Bus monitoring PROFIBUS RS 485-iS (secondary)	Yellow LED "DP2"	
• Monitoring 24 V power supply	Green LED "ON"	
Technical safety notice		
V _{DC}	±4.2 V	
I _{SC}	±93 mA	
P ₀	0.1 Watts	
V _{max}	±4.2 V	
L _I	0	
C _i	0	
U _m	AC 250 V	
T _a	-25 ... +60 °C	
RS 485-IS segment		
permitted cable length on a single line	RS 485-iS	DP Ex i
• 9.6 to 187.5 Kbps	1 000 m	200 m
• 500 kbit/s	400 m	200 m
• 1.5 Mbps	200 m	200 m
Number of PROFIBUS DP nodes that can be connected, max.	31	16
PROFIBUS RS 485-iS bus terminator switch	integrated, can be added	

SIMATIC PCS 7 system hardware

Process I/O

SIMATIC ET 200iSP

Stainless steel wall enclosures

Design

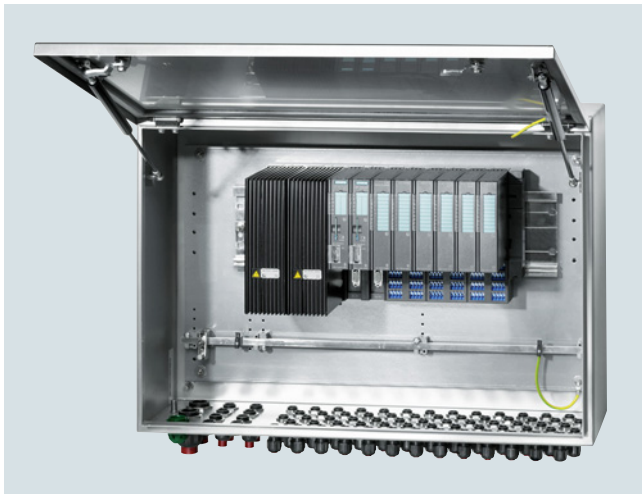

ET 200iSP modules can also be installed in stainless steel wall enclosures designed to meet more exacting degree of protection requirements. The enclosures are available in various sizes. They comply with degree of protection IP65 and can be used in Ex zones 1 and 21.

Delivery can be an empty enclosure or include components, depending on the order.

Send your request to:
cabinets.industry@siemens.com

Ordering data

Article No.

Stainless steel enclosure IP65 for SIMATIC ET 200iSP	6DL2804-
I/O enclosure	
Surface casing in stainless steel, max. IP66, with mounting plate and equipotential bonding rail, empty enclosure for installation of ET 200iSP components ¹⁾	0
I/O device consisting of surface casing with installed ET 200iSP components ²⁾	1
I/O device consisting of surface casing with installed ET 200iSP and pneumatic components ²⁾	2
Device group	
Device group II, up to zone 1 (including zone 2)	A
Device group II, up to zone 21 (including zone 22)	D
Enclosure dimensions W x H x D (in mm)	
650 x 450 x 230, for 15 ET 200iSP modules in non-redundant configuration	D
950 x 450 x 230, for 25 ET 200iSP modules in non-redundant configuration	E
800 x 800 x 300, for 2 rows with max. 30 ET 200iSP modules	K
1000 x 1000 x 300, for 2 rows with max. 42 ET 200iSP modules	T
1000 x 1200 x 300, for 2 rows with max. 42 ET 200iSP modules	U
Cable entries/number	
M16 cable entries for signals, 3 rows, 39 or 66 units ³⁾ , 2 x M32 for supply voltage, 4 x M20 for bus cables	3
M20 cable entries for signals, 3 rows, 36 or 57 units ³⁾ , 2 x M32 for supply voltage, 4 x M20 for bus cables	4
M16 cable entries for signals, 5 rows, 65 or 110 units ³⁾ , 2 x M32 for supply voltage, 4 x M20 for bus cables	5
M20 cable entries for signals, 5 rows, 60 or 95 units ³⁾ , 2 x M32 for supply voltage, 4 x M20 for bus cables	6
Icotek cable entry strip IP65, for up to 45 or 90 signals ³⁾ , 2 x M32 for supply voltage, 4 x M20 for bus cables	7

Article No.

Stainless steel enclosure IP65 for SIMATIC ET 200iSP	6DL2804-
Cable entries/material	
Cable entry in plastic, black	0
Ambient operating temperatures: <ul style="list-style-type: none"> • Surface casing -40...+70 °C • I/O device -40 ... +xx °C⁴⁾⁵⁾ 	
Cable entry in metal (nickel-plated brass)	1
Ambient operating temperatures: <ul style="list-style-type: none"> • Surface casing -40...+70 °C • I/O device -40 ... +xx °C⁴⁾⁵⁾ 	
Cable entry in plastic, blue	2
Ambient operating temperatures: <ul style="list-style-type: none"> • Surface casing -40...+70 °C • I/O device -40 ... +xx °C⁴⁾⁵⁾ 	
Icotek cable entry in plastic, gray HN-24 frame	3
Ambient operating temperatures: <ul style="list-style-type: none"> • Surface casing -40...+70 °C • I/O device -40 ... +xx °C⁴⁾⁵⁾ 	

¹⁾ The supplied certificate is only valid for the empty enclosure.

²⁾ The included certificate is valid for the supplied enclosure including the installed components.

³⁾ Number of cable entries/signals depends on enclosure dimensions

⁴⁾ Maximum temperature depends on installed components.

⁵⁾ Minus temperatures down to -40 °C when heater installed. This takes up 2 slots for ET 200iSP modules.

Note:

Depending on the cables used, other types and sizes of cable entries can be fitted (on request).

Options

Special configurations

For special configurations which differ from the standard configurations, we will gladly make you a customized offer to suit your individual needs.

Please send your request to
cabinets.industry@siemens.com

Overview



Within the SIMATIC ET 200 range, ET 200M represents one of the main series of distributed I/O systems for process control applications with SIMATIC PCS 7.

The ET 200M I/O system offers a comprehensive range of I/O modules of S7-300 design, including ones with special I&C functions:

- Standard analog and digital modules
- Redundant I/O modules
- I/O modules with enhanced diagnostics capability
- Ex I/O modules
- Controller and counter modules
- HART modules
- F-modules for safety-related applications

When using active bus modules, faulty I/O modules can be replaced while the plant is in operation (RUN) without influencing adjacent modules (hot swapping function).

The following actions are possible with the automation system in RUN:

- Adding new modules to the station
- Re-configuration of modules
- Addition of ET 200M stations
- Configuration of connected HART field devices with SIMATIC PDM

Note:

Apart from these selected modules, it is also possible to use - with limitations in functions - all other I/O modules from the current range of S7-300 signal modules.

Design

An ET 200M remote I/O station comprises:

- 1 or 2 (redundant) power supply modules (can be omitted in the case of a central 24 V DC supply for the plant)
- Up to 2 interface modules:
 - 1 or 2 (redundant) IM 153-2 High Feature for PROFIBUS DP connection or
 - 1 IM 153-4 PN High Feature for PROFINET connection
- Up to 12 I/O modules for connection of sensors/actuators

All I/O modules have optical electrical isolation from the backplane bus. Up to 12 I/O modules can be connected to an IM 153-2 High Feature or IM 153-4 PN High Feature interface module. The IM 153-2 High Feature interface modules can also be configured redundantly.

In addition to the standard SIMATIC S7 I/O modules, special I/O modules with diagnostics capability offer the following functions, among others:

- Channel-based diagnostics, e.g. open-circuit, short-circuit, limit violations
- Internal module monitoring, e.g. configuration error, RAM error, tripped fuse
- Flatter monitoring for sensors
- Pulse stretching
- Output of a programmable substitute value on failure of the central unit

In the event of a fault, the modules with diagnostics capability automatically pass on the corresponding message to the operator station, permitting fast and simple troubleshooting.

The ET 200M stations can be operated in standard environments as well as in Ex zone 2. The actuators/sensors can be positioned in Ex zone 1/21 when suitable Ex input/output modules are used. Hot swapping of I/O modules within Ex zone 2 is allowed with the right permit (e.g. fire certificate).

Technical specifications

You can find detailed technical data on the ET 200M and S7-300 I/O modules in the following places:

- Catalog ST 70, Chapter "IO Systems" or
- Industry Mall/CA 01 under "Automation technology - Automation systems - SIMATIC industrial automation systems - IO systems - SIMATIC ET 200 systems for control cabinets" - SIMATIC ET 200M"

Options

SIPLUS extreme range for extended temperature ranges and corrosive environments

The "standard" properties of an individual device or system are often insufficient for harsh environmental conditions, applications in corrosive environments or extreme temperature ranges. Depending on the location of use, the result could be limitations in functionality or operational safety or even total failure of the plant.

The SIPLUS extreme range offers individually adapted standard products which permit retention of the functionality of your plant or process even under extreme conditions of use. These include:

- Ambient temperature range from -25 to +60/+70 °C
- Condensation, high humidity
- Increased mechanical stress
- Extreme loading by media, e.g. toxic atmospheres
- Voltage ranges deviating from the standard
- Increased degree of protection (dust, water)

You can find a summary of the available range of products classified according to their special properties on the Internet. The corresponding SIPLUS product is assigned there to the standard product:

<http://www.siemens.com/siplus>

Note:

SIPLUS products are also included in the ST 70 Catalog.

SIMATIC PCS 7 system hardware

Process I/O

SIMATIC ET 200M for SIMATIC PCS 7

Power supply**Overview**

You can use the PS 307 or PS 305 load power supplies as the power supply module for the ET 200M. You can select different input voltages and output currents (120/230 V AC with 2 A, 5 A or 10 A or 24 to 110 V DC with 2 A) depending on the application.

With a redundant ET 200M configuration, it is also recommendable to have a redundant 24 V DC supply, e.g. with two PS 307/PS 305 load current supplies.

Ordering data**Article No.****PS 307 load power supply**

with power connector

- 120/230 V AC; 24 V DC
 - 2 A; 40 mm wide
 - 5 A; 60 mm wide
 - 5 A, extended temperature range; 80 mm wide
 - 10 A, 80 mm wide

6ES7307-1BA01-0AA0**6ES7307-1EA01-0AA0****6ES7307-1EA80-0AA0****6ES7307-1KA02-0AA0****PS 305 load power supply**

with power connector

- 24/48/60/110 V DC; 24 V DC
 - 2 A, extended temperature range; 80 mm wide

6ES7305-1BA80-0AA0

Overview

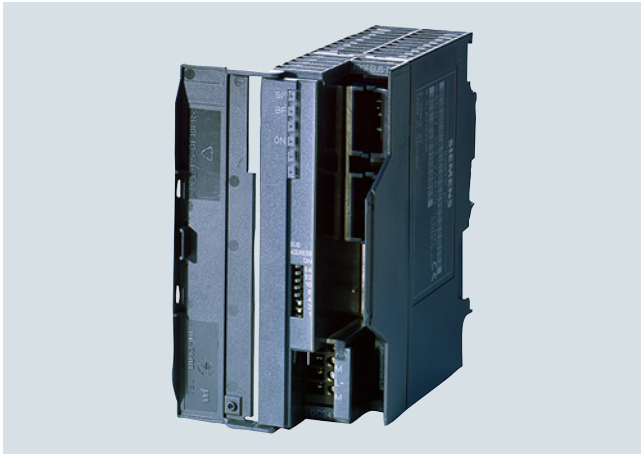

Interface module IM 153-2 High Feature Outdoor for PROFIBUS connection

Interface module for the PROFIBUS connection

The IM 153-2 High Feature and IM 153-2 High Feature Outdoor (electrical PROFIBUS DP transmission mode) interface modules are available for connecting the ET 200M remote I/O station to the PROFIBUS DP fieldbus. Depending on the fieldbus configuration (single/redundant), the ET 200M remote I/O station can be connected via one single or two redundant interface modules.



IM 153-4 High Feature interface module for PROFINET connection

Interface module for PROFINET connection

The IM 153-4 PN High Feature interface module is used to connect the ET 200M remote I/O station to PROFINET via copper cables (RJ45). It autonomously handles communication between the I/O modules and the higher-level PROFINET I/O controller.

Function

IM 153-2 High Feature and IM 153-2 High Feature Outdoor

The IM 153-2 High Feature and IM 153-2 High Feature Outdoor support the following functions:

- HART configuring of intelligent field devices
- Configuration of ET 200M I/Os in RUN mode of the automation system
- Connection to redundant automation systems
- Use of ET 200M function modules (controller and counter modules)
- Operation of up to 12 I/O modules per remote I/O station
- Time stamping (SOE) with the safety-related SM 326F digital input module (F-DI24)
- Transmission of additional values with HART secondary variables of the HART SM 331 and SM 332 analog modules (up to 4 per channel or up to 8 per module)

IM 153-4 PN High Feature

- Integrated 2-port switch
- Baud rate 10 Mbps / 100 Mbps (Autonegotiation/Full Duplex)
- Operation of up to 12 I/O modules per remote I/O station
- I&M functions in accordance with PROFIBUS International Guidelines, order no. 3.502, version V1.1

Note:

In order to be able to use the hot swap function, use of the active bus module and the mounting rail for hot swap is necessary (see under the following section "Accessories").

Ordering data

Article No.

Interface module for the PROFIBUS connection

IM 153-2 High Feature Outdoor
 Interface module for PROFIBUS DP for ET 200M, PA Link and Y Link; redundancy capable; conformal coating, IP20 degree of protection; permissible operating temperature -25 ... +60 °C

6ES7153-2BA70-0XB0

IM 153-2 High Feature
 Interface module for PROFIBUS DP for ET 200M; redundancy capable; permissible operating temperature 0 ... +60 °C

6ES7153-2BA10-0XB0

Interface module for the PROFINET connection

IM 153-4 PN High Feature
 Interface for connecting an ET 200M station to PROFINET

6ES7153-4BA00-0XB0

SIMATIC PCS 7 system hardware

Process I/O

SIMATIC ET 200M for SIMATIC PCS 7

Accessories

Overview

Following components are available as accessories for the ET 200M:

- Bus modules for connection/disconnection of modules during operation (hot swapping)
- DIN rail for connection and disconnection of modules during operation
- Covers for backplane bus and bus modules
- Front connectors
- Ex partition for ET 200M
- DM 370 dummy module
- LK 393 cable guide



Ex partition for ET 200M

Ex partition

A mechanical isolation is required between the IM 153 interface module and the first Ex I/O module. For the hot swapping function, an Ex partition is installed which guarantees the prescribed isolation distance between non-intrinsically-safe and intrinsically-safe areas of an ET 200M remote I/O station.

Note:

The Ex partition must be used in connection with bus modules with active backplane bus. If no bus modules with active backplane bus are being used, the DM 370 dummy module can be used instead.



DM 370 dummy module

DM 370 dummy module

- Reservation of slots for unconfigured I/O modules
- Retention of design and address assignment when replacing by I/O module

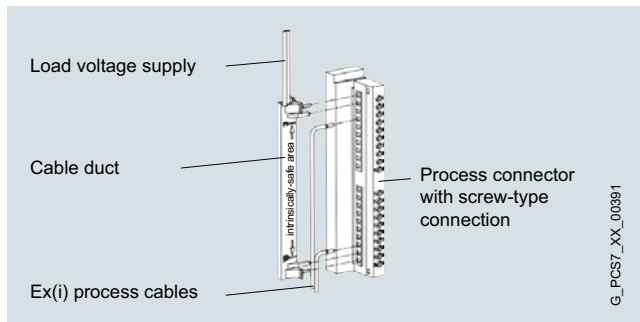

LK 393 cable guide

LK 393 cable guide

The LK 393 cable duct provides the prescribed isolation between the load voltage input and the intrinsically safe inputs/outputs. The cable duct is easy to fit following insertion of the load voltage inputs L+.

Design

Redundant connection

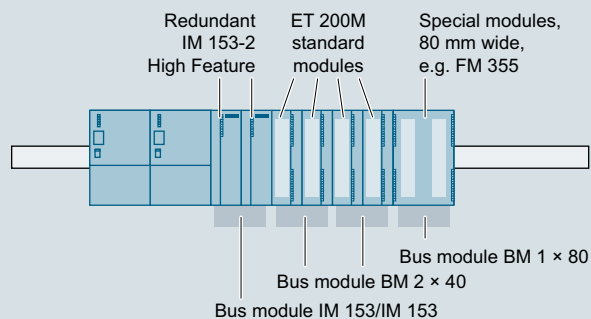

Singular connection

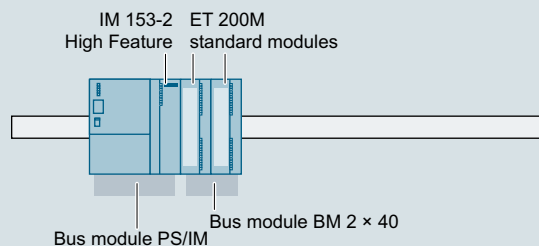

The figure shows the use of the various bus modules for hot swapping modules - at the top for a redundant connection, at the bottom for a non-redundant connection.

G_PCS7_XX_00184

Ordering data	Article No.	Article No.	
Bus modules for hot swapping <ul style="list-style-type: none"> BM PS/IM for load current supply and IM 153, including 1 bus module cover BM 2 × 40 for 2 modules, width 40 mm BM 1 × 80 for 1 module, width 80 mm BM IM/IM Outdoor for 2 IM 153-2 for configuring redundant systems BM IM/IM for 2 IM 153-2/-2 FO for configuring redundant systems 	6ES7195-7HA00-0XA0 6ES7195-7HB00-0XA0 6ES7195-7HC00-0XA0 6ES7195-7HD80-0XA0 6ES7195-7HD10-0XA0	Front connector for Ex analog input module 6ES7331-7SF00-0AB0 (1 unit) <ul style="list-style-type: none"> 20-pin, with screw contacts Enables an accuracy of ±1.5 °K for the internal cold junction temperature when taking thermocouple temperature measurements in the "internal compensation" measuring mode at ambient temperatures of 0 to 60 °C	6ES7392-1AJ20-0AA0
DIN rail for hot swapping <ul style="list-style-type: none"> 482 mm long (19 inches) 530 mm long 620 mm long 2 000 mm long, for vertical installation 	6ES7195-1GA00-0XA0 6ES7195-1GF30-0XA0 6ES7195-1GG30-0XA0 6ES7195-1GC00-0XA0	Ex partition for ET 200M¹⁾ <ul style="list-style-type: none"> Separation of IM 153 and downstream Ex modules within an ET 200M line Mixed operation of non-Ex and Ex modules within an ET 200M line For supporting the hot swapping function in connection with IM 153-2 	6ES7195-1KA00-0XA0
Covers Package with 4 backplane bus covers and 1 bus module cover	6ES7195-1JA00-0XA0	DM 370 dummy module¹⁾ Including bus connector, labeling strips	6ES7370-0AA01-0AA0
Front connector (1 unit) <ul style="list-style-type: none"> 20-pin, with screw contacts 20-pin, with spring contacts 40-pin, with screw contacts 40-pin, with spring contacts 	6ES7392-1AJ00-0AA0 6ES7392-1BJ00-0AA0 6ES7392-1AM00-0AA0 6ES7392-1BM01-0AA0	LK 393 cable duct [EEx ib] IIC-conform routing of load voltage cable in front plug, 5 units	6ES7393-4AA00-0AA0

¹⁾ The Ex partition must be used in connection with bus modules with active backplane bus. If no bus modules with active backplane bus are being used, the DM 370 dummy module can be used instead.

SIMATIC PCS 7 system hardware

Process I/O

SIMATIC ET 200M for SIMATIC PCS 7

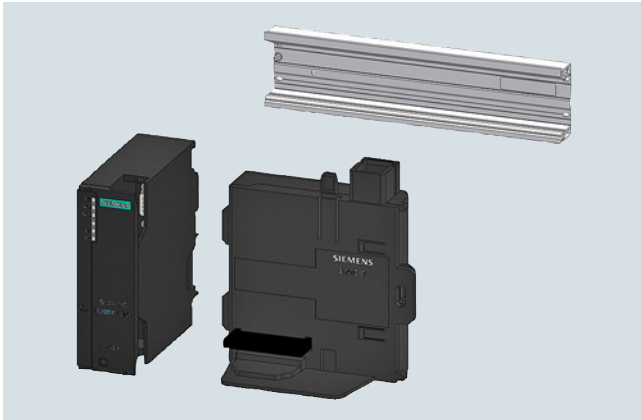
Bundles**Overview**

I/O subsystem for ET 200M

The following bundles are available for ET 200M:

- I/O subsystem for PA Link or ET 200M stations with up to 8 I/O modules suitable for hot swapping, consisting of:
 - DIN rail for active bus modules, 482 mm long (19 inches)
 - PS/IM bus module
 - PROFIBUS DP interface IM 153-2 High Feature Outdoor
- I/O subsystem extended for PA Link or ET 200M stations with up to 12 I/O modules suitable for hot swapping, consisting of:
 - DIN rail for active bus modules, 620 mm long
 - PS/IM bus module
 - PROFIBUS DP interface IM 153-2 High Feature Outdoor
- RED I/O subsystem for operation of a PA Link or an ET 200M station on a redundant automation system of the S7-400 series, suitable for hot swapping, consisting of:
 - 2 PROFIBUS DP interface modules IM 153-2 High Feature Outdoor
 - 1 active bus module IM/IM Outdoor

Ordering data**Article No.****I/O subsystem for PA Link or ET 200M**

For PA Link or for ET 200M stations with up to 8 I/O modules, suitable for hot swapping, consisting of:

- DIN rail for active bus modules, 482 mm long (19 inches)
- PS/IM bus module
- PROFIBUS DP interface IM 153-2 High Feature Outdoor

6ES7654-0XX10-1XA0**I/O subsystem extended for PA Link or ET 200M**

For PA Link or for ET 200M stations with up to 12 I/O modules, suitable for hot swapping, consisting of:

- DIN rail for active bus modules, 620 mm long
- PS/IM bus module
- PROFIBUS DP interface IM 153-2 High Feature Outdoor

6ES7654-0XX10-1XB0**RED I/O subsystem for PA Link or ET 200M**

For operation of a PA Link or an ET 200M station on a redundant automation system of the S7-400 series, suitable for hot swapping, consisting of:

- 2 PROFIBUS DP interfaces IM 153-2 High Feature Outdoor
- 1 active bus module IM/IM Outdoor

6ES7654-0XX20-0XA0

Overview



Digital input modules

- Simple signal modules for DC and AC voltage
- Modules with diagnostics capability that automatically output a corresponding message to the Operator System in the event of a fault

Digital output modules

- Simple signal modules for DC and AC voltage with different output currents per channel, where various relay modules are available for larger output currents and voltages
- Modules with diagnostics capability which provide information for fault diagnosis and also permit parameterizable reactions to failure of the automation system

Digital input/output modules

- Standard signal module for DC voltage (24 V DC) with 8 digital inputs and 8 digital outputs
- For connection of switches, 2-wire proximity switches (BERO), solenoid valves, contactors, signal lamps

Ordering data

Article No.

Article No.

Digital input modules

SM 321 for floating contacts (supply with DC voltage)	
16 inputs, 24 V DC Redundancy optional (module-granular redundancy) • Isolated in groups of 16 • Front connector required: 20-pin	6ES7321-1BH02-0AA0
16 inputs, 24 V DC • Isolated in groups of 16; active low • Front connector required: 20-pin	6ES7321-1BH50-0AA0
16 inputs, 24 V DC, high-speed • Isolated in groups of 16 • 0.05 ms input delay • Front connector required: 20-pin	6ES7321-1BH10-0AA0
32 inputs, 24 V DC Redundancy optional (module-granular redundancy) • Isolated in groups of 16 • Front connector required: 40-pin	6ES7321-1BL00-0AA0
16 inputs, 48 ... 125 V DC • Isolated in groups of 8 • Front connector required: 20-pin	6ES7321-1CH20-0AA0
64 inputs, 24 V DC • Isolated in groups of 16; active high/low Note: 2 connection cables 6ES7392-4B..0-0AA0 and 2 terminal blocks 6ES7392-1.N00-0AA0 required per module.	6ES7321-1BP00-0AA0
S7-300 cable for 64-channel modules; 2 units • 1 m • 2.5 m • 5 m	6ES7392-4BB00-0AA0 6ES7392-4BC50-0AA0 6ES7392-4BF00-0AA0

Terminal block for 64-channel modules; 2 units • With screw contacts • With spring-loaded contacts	6ES7392-1AN00-0AA0 6ES7392-1BN00-0AA0
SM 321 for floating contacts (supply with DC/AC voltage)	
16 inputs, 24 ... 48 V AC/DC • Isolated in groups of 1 • Front connector required: 40-pin	6ES7321-1CH00-0AA0
SM 321 for floating contacts (supply with AC voltage)	
32 inputs, 120 V AC • Isolated in groups of 8 • Front connector required: 40-pin	6ES7321-1EL00-0AA0
8 inputs, 120/230 V AC Redundancy optional (module-granular redundancy) • Isolated in groups of 2 • Front connector required: 20-pin	6ES7321-1FF01-0AA0
16 inputs, 120/230 V AC • Isolated in groups of 4 • Front connector required: 20-pin	6ES7321-1FH00-0AA0
SM 321 for non-floating contacts (supply with AC voltage)	
8 inputs, 120/230 V AC • Isolated in groups of 1 • Front connector required: 40-pin	6ES7321-1FF10-0AA0

SIMATIC PCS 7 system hardware

Process I/O

SIMATIC ET 200M for SIMATIC PCS 7

Digital modules

Ordering data

Article No.

SM 321 modules with diagnostics capability (IM 153-2 High Feature interface module required) for isolated contacts (supplied with DC voltage)

16 inputs, 24 V DC
Redundancy optional
(channel-granular redundancy)

- Isolated in groups of 16
- Time stamping in association with IM 153-2 High Feature, accuracy 1 ms, rising or falling edge, can be configured channel-granular
- Two short-circuit-proof sensor supplies for 8 channels each
- Sensor supply by the module, additional external redundant sensor supply possible
- Diagnostics of missing sensor supply for channel group (8 channels)
- Diagnostics inside module
- Channel-granular wire break monitoring
- Front connector required: 20-pin

6ES7321-7BH01-0AB0

16 inputs, NAMUR
Redundancy optional
(channel-granular redundancy)

- Isolated in groups of 8
- Time stamping in association with IM 153-2 High Feature, accuracy 10 ms, rising or falling edge, can be configured channel-granular
- Two sensor supplies (8.2 V DC or 18 V DC each)
- Connection of NAMUR sensors or contacts with resistor circuit
- Pulse stretching
- Channel-granular diagnostics (short-circuit, open-circuit, chatter monitoring, discrepancy with changeover contacts)
- Diagnostics inside module
- Front connector required: 40-pin

6ES7321-7TH00-0AB0

16 inputs, 24 to 125 V DC

- Isolated in groups of 16
- Time stamping in association with IM 153-2 High Feature, accuracy 1 ms, rising or falling edge, can be configured channel-granular
- Diagnostics inside module
- Channel-granular wire break monitoring
- Front connector required: 40-pin

6ES7321-7EH00-0AB0

Digital output modules

SM 322 for DC voltage
Suitable for solenoid valves, contactors, indicator lights, etc.

8 outputs, 24 V DC / 2 A
Redundancy optional
(channel-granular redundancy)

- Isolated in groups of 4
- Front connector required: 20-pin

6ES7322-1BF01-0AA0

16 outputs, 24 V DC, 0.5 A

- Isolated in groups of 8
- Front connector required: 20-pin

6ES7322-1BH01-0AA0

16 outputs, 24 V DC / 0.5 A, high speed

- Isolated in groups of 8
- Output delay max. 0.2 ms
- Front connector required: 20-pin

6ES7322-1BH10-0AA0

32 outputs, 24 V DC / 0.5 A
Redundancy optional
(module-granular redundancy)

- Isolated in groups of 8
- Front connector required: 40-pin

6ES7322-1BL00-0AA0

8 outputs, 48 ... 125 V DC / 1.5 A

- Isolated in groups of 4
- Front connector required: 20-pin

6ES7322-1CF00-0AA0

64 outputs, 24 V DC, 0.3 A, source output

- Isolated in groups of 16

6ES7322-1BP00-0AA0

Note:
2 connection cables
6ES7392-4B..0-0AA0 and
2 terminal blocks
6ES7392-1.N00-0AA0
required per module.

64 outputs, 24 V DC, 0.3 A, sink output

- Isolated in groups of 16

6ES7322-1BP50-0AA0

Note:
2 connection cables
6ES7392-4..0-0AA0 and 2 terminal
blocks 6ES7392-1.N00-0AA0
required per module.

S7-300 cable for 64-channel modules; 2 units

- 1 m
- 2.5 m
- 5 m

6ES7392-4BB00-0AA0

6ES7392-4BC50-0AA0

6ES7392-4BF00-0AA0

Terminal block for 64-channel modules; 2 units

- With screw contacts
- With spring-loaded contacts

6ES7392-1AN00-0AA0

6ES7392-1BN00-0AA0

SM 322 for AC voltage
Suitable for AC solenoid valves, contactors, motor starters, small-power motors and indicator lights

8 outputs, 120/230 V AC / 2 A
Redundancy optional
(module-granular redundancy)

- Isolated in groups of 4
- Front connector required: 20-pin

6ES7322-1FF01-0AA0

16 outputs, 120/230 V AC, 1 A

- Isolated in groups of 8
- Front connector required: 20-pin

6ES7322-1FH00-0AA0

32 outputs, 120/230 V AC, 1 A

- Isolated in groups of 8
- Front connector required: 2 × 20-pin

6ES7322-1FL00-0AA0

Ordering data	Article No.	Ordering data	Article No.
SM 322 for relay output Suitable for AC/DC solenoid valves, contactors, motor starters, small-power motors, and indicator lights		for AC voltage Suitable for AC solenoid valves, contactors, motor starters, small-power motors and indicator lights	
8 outputs, 24 ... 120 V DC, 48 ... 230 V AC, max. 2 A <ul style="list-style-type: none"> Isolated in groups of 2 Front connector required: 20-pin 	6ES7322-1HF01-0AA0	8 outputs, 120/230 V AC, 2 A <ul style="list-style-type: none"> Isolated in groups of 1 Connection of a default value per channel in the event of CPU stop (configurable) Module-internal diagnostics functions Front connector required: 40-pin 	6ES7322-5FF00-0AB0
8 outputs, 24 ... 120 V DC, 48 ... 230 V AC, max. 5 A <ul style="list-style-type: none"> Isolated in groups of 1 Front connector required: 40-pin 	6ES7322-1HF10-0AA0	16 outputs, 24/48 V DC, 0.5 A <ul style="list-style-type: none"> Isolated in groups of 1 Connection of a default value per channel in the event of CPU stop (configurable) Module-internal diagnostics functions Front connector required: 40-pin 	6ES7322-5GH00-0AB0
16 outputs, 24 ... 120 V DC, 48 ... 230 V AC, max. 2 A <ul style="list-style-type: none"> Isolated in groups of 8 Front connector required: 20-pin 	6ES7322-1HH01-0AA0	For relay output Suitable for AC/DC solenoid valves, contactors, motor starters, small-power motors and indicator lights	
SM 322 modules with diagnostics capability (with channel and module diagnostics) for DC voltage Suitable for solenoid valves, DC contactors and indicator lights		8 outputs, 24 ... 120 V DC, 24 ... 230 V AC, max. 5 A <ul style="list-style-type: none"> Isolated in groups of 1 With RC suppressor element for protection of contacts per channel Connection of a default value per channel in the event of CPU stop (configurable) Module-internal diagnostics functions Front connector required: 40-pin 	6ES7322-5HF00-0AB0
8 outputs, 24 V DC / 0.5 A Redundancy optional (module-granular redundancy) <ul style="list-style-type: none"> Isolated in groups of 8 2 connections per output (with and without series diode) Connection of a default value per channel in the event of CPU stop (configurable) Wire break monitoring per channel Load voltage monitoring per channel Short-circuit monitoring to M/L+ per channel Module-internal diagnostics functions Front connector required: 20-pin 	6ES7322-8BF00-0AB0	Digital input/output modules	
16 outputs, 24 V DC / 0.5 A Redundancy optional (module-granular redundancy) <ul style="list-style-type: none"> Isolated in groups of 4 Connection of a default value per channel in the event of CPU stop (configurable) Wire break monitoring per channel (with 0 and 1 signals) Signaling of output overload Discrepancy error monitoring Load voltage monitoring or ground monitoring per channel group Short-circuit monitoring to M/L+ per channel group Module-internal diagnostics functions Front connector required: 40-pin 	6ES7322-8BH10-0AB0	SM 323 for DC voltage Suitable for switches, BERO proximity switches, solenoid valves, contactors, indicator lights, etc.	
		<ul style="list-style-type: none"> 8 inputs 24 V DC <ul style="list-style-type: none"> Suitable for connection of 2-wire proximity switches (BERO) as sensors 8 outputs, 24 V DC, 0.5 A Inputs and outputs electrically isolated in groups of 8 Front connector required: 20-pin 	6ES7323-1BH01-0AA0

The technical specifications of the other modules listed in the ordering data can be found in Catalog ST 70.

SIMATIC PCS 7 system hardware

Process I/O

SIMATIC ET 200M for SIMATIC PCS 7

Digital modules**Technical specifications**

Article number	6ES7321-7TH00-0AB0	6ES7321-7EH00-0AB0
	SM321, 16 DI, 24V DC, DIAGNOSTICS	SM 321; 16DI, DC 24/125 V
Supply voltage		
Load voltage L+		
• Rated value (DC)	24 V	24 V
Input current		
from load voltage L+ (without load), max.	100 mA	
from backplane bus 5 V DC, max.	100 mA	90 mA
Encoder supply		
Number of outputs	4	
Output current		
• Rated value	190 mA; at 18V: 190mA, at 8.2V: 60mA	
Power loss		
Power loss, typ.	11 W	2 W; V _{in} = 24 V DC
Digital inputs		
Number of digital inputs	16	16
Input characteristic curve in accordance with IEC 61131, type 1	No	Yes
Input characteristic curve in accordance with IEC 61131, type 2	Yes	
Input voltage		
• Type of input voltage	DC	
• Rated value (DC)	8.2 V; 8.2V/18V	24 V; 24 V DC to 125 V DC
• for signal *0*		-146 to 5V
• for signal *1*		15 to 146V
Input current		
• for signal *1*, typ.	10 mA; for NAMUR: 2.1 to 7 mA, for 10k ohm/47k ohm contact: typical 10mA, for 4 wire BEROs: typical 10 mA	3.5 mA
Input delay (for rated value of input voltage) for standard inputs		
- parameterizable		Yes; 0.1 / 0.5 / 3 / 15 / 20 ms
- at *0* to *1*, min.	2.5 ms	
- at *0* to *1*, max.	3.5 ms	
Cable length		
• shielded, max.	400 m; max. 200m with 8.2 V sensor, max. 400m with 18 V sensor	1 000 m
Encoder		
Connectable encoders		
• 2-wire sensor		Yes
- permissible quiescent current (2-wire sensor), max.		1 mA
Interrupts/diagnostics/status information		
Alarms	Yes	
Diagnostics function	Yes	Yes; Parameterizable
Alarms		
• Diagnostic alarm	Yes	Yes; Parameterizable
• Hardware interrupt	Yes	Yes; Parameterizable
Ambient conditions		
Ambient temperature during operation		
• min.	0 °C	0 °C
• max.	60 °C	60 °C
Connection method		
required front connector	1x 40-pin	1x 40-pin
Dimensions		
Width	40 mm	40 mm
Height	125 mm	125 mm
Depth	120 mm	120 mm
Weights		
Weight, approx.		200 g

Technical specifications (continued)

Article number	6ES7322-8BH10-0AB0 SM322, 16DO, 24V DC, 0,5A
Supply voltage	
Load voltage L+	
• Rated value (DC)	24 V
Input current	
from load voltage L+ (without load), max.	100 mA
from backplane bus 5 V DC, max.	100 mA
Power loss	
Power loss, typ.	6 W
Digital outputs	
Number of digital outputs	16
Short-circuit protection	Yes
Limitation of inductive shutdown voltage to	L+ (-68 V)
Switching capacity of the outputs	
• on lamp load, max.	5 W
Load resistance range	
• lower limit	48 Ω
• upper limit	4 kΩ
Output voltage	
• for signal *1*, min.	L+ (-0.7 V)
Output current	
• for signal *1* rated value	0.5 A
• for signal *0* residual current, max.	0.7 mA
Switching frequency	
• with resistive load, max.	100 Hz
• on lamp load, max.	10 Hz
Total current of the outputs (per group)	
horizontal installation	
- up to 60 °C, max.	2 A
vertical installation	
- up to 40 °C, max.	2 A
Cable length	
• shielded, max.	1 000 m

Article number	6ES7322-8BH10-0AB0 SM322, 16DO, 24V DC, 0,5A
Interrupts/diagnostics/status information	
Alarms	Yes
Diagnostics function	Yes
Alarms	
• Diagnostic alarm	Yes
Connection method	
required front connector	1x 40-pin
Dimensions	
Width	40 mm
Height	125 mm
Depth	120 mm
Weights	
Weight, approx.	350 g

SIMATIC PCS 7 system hardware

Process I/O

SIMATIC ET 200M for SIMATIC PCS 7

Analog modules**Overview****Analog input modules**

- Multi-function modules for current, voltage and temperature measurements
- Special, highly accurate modules for current and voltage measurements or temperature measurements

All modules automatically supply channel-specific and module-internal diagnostics data, except module 6ES7331-1KF02-0AB0. With this module, a channel failure is detected by the SIMATIC PCS 7 analog driver block.

The channels of the analog input modules can be parameterized in groups independent of each other.

Analog output modules

- Modules with 12-bit resolution and different numbers of channels
- Highly accurate module with 15-bit resolution

The analog output modules can be parameterized in groups independent of each other, and automatically provide all channel-specific and module-internal diagnostics information.

Ordering data**Article No.****Article No.****Analog input modules****SM 331 modules for current, voltage and temperature measurements****8 inputs, individually configurable**

- Resolution 12 bit + sign
- Current measurement (8 channels) 0/4 ... 20 mA, ±20 mA (2 wires with external supply or 4 wires)
- Voltage measurement (8 channels) 1 ... 5 V, 0 ... 10 V, ±50 mV, ±500 mV, ±1 V, ±5 V, ±10 V
- Resistance thermometer Pt100, Ni100, Ni1000, LG-Ni1000 (8 channels; 2, 3 or 4 wires)
- Front connector required: 40-pin

6ES7331-1KF02-0AB0**8 inputs in 4 channel groups Redundancy optional**

- (module-granular redundancy)
- Changeover of measurement type by range module per channel group
 - Resolution 14 bit + sign
 - Current measurement (8 channels) 0 ... 20 mA, ±3.2 mA, ±10 mA, ±20 mA (4 wires) or 4 ... 20 mA (2 or 4 wires)
 - Voltage measurement (8 channels) 1 ... 5 V, 0 ... 10 V, ±50 mV, ±500 mV, ±1 V, ±5 V, ±10 V
 - Resistance thermometer Pt100, Ni100 (4 channels; 2, 3 or 4 wires)
 - Thermocouples type E, N, J, K, L (8 channels)
Internal compensation or external compensation with compensating box or 0 °C cold junction
 - Wire break monitoring
 - Internal module diagnostics
 - Front connector required: 20-pin

6ES7331-7KF02-0AB0**2 inputs in 1 channel group**

- Changeover of measurement type by range module
- Adjustable resolution per channel group: 9/12/14 bits + sign
- Current measurement (2 channels) 0 ... 20 mA, ±3.2 mA, ±10 mA, ±20 mA (4 wires) or 4 ... 20 mA (2 or 4 wires)
- Voltage measurement (2 channels) 1 ... 5 V, ±80 mV, ±250 mV, ±500 mV, ±1 V, ±2.5 V, ±5 V, ±10 V
- Resistance thermometer Pt100, Ni100 (1 channel, 2 or 4 wires)
- Thermocouples type E, N, J, K, L (2 channels)
Internal compensation or external compensation with compensating box or 0 °C cold junction
- Wire break monitoring
- Internal module diagnostics
- Front connector required: 20-pin

6ES7331-7KB02-0AB0

Ordering data	Article No.	Ordering data	Article No.
SM 331 modules for current and voltage measurements		SM 331 modules for temperature measurement	
8 inputs in 4 channel groups, high speed <ul style="list-style-type: none"> Resolution 13 bit + sign Measurement type and range selection adjustable per channel group Current measurement 0 ... 20 mA, ±20 mA (4 wires) or 4 ... 20 mA (2 or 4 wires) Voltage measurement 1 ... 5 V, ±1 V, ±5 V, ±10 V Limit monitoring adjustable for 2 channels Fast updating of measured value Supporting of isochronous mode Internal module diagnostics Front connector required: 20-pin 	6ES7331-7HF01-0AB0	8 inputs in 4 channel groups <ul style="list-style-type: none"> Resolution 15 bit + sign Resistance thermometer Pt100 ... 1000, Ni100 ... 1000, Cu10 (8 channels; 2, 3 or 4 wires) Resistance measurement 150 Ω, 300 Ω, 600 Ω Measuring mode (temperature or resistance) and measuring range adjustable per channel group Short-circuit-proof Wire break monitoring Internal module diagnostics Front connector required: 40-pin 	6ES7331-7PF01-0AB0
8 inputs in 4 channel groups Redundancy optional (channel-granular redundancy) <ul style="list-style-type: none"> Resolution 15 bit + sign Current measurement 0/4 ... 20 mA, ±20 mA (8 channels; 2 or 4 wires) Voltage measurement 1 ... 5 V, ±5 V, ±10 V (8 channels) Wire break monitoring with 4 ... 20 mA and 1 ... 5 V Internal module diagnostics Front connector required: 40-pin 	6ES7331-7NF00-0AB0	8 inputs in 4 channel groups <ul style="list-style-type: none"> Resolution 15 bit + sign Thermocouples type B, C, N, E, R, S, J, L, T, K, U (8 channels), internal compensation; external compensation with Pt100 through separate inputs possible Measuring range adjustable per channel group Fast module cycle (10 ms for 4 channels) Short-circuit-proof Wire break monitoring Internal module diagnostics Front connector required: 40-pin 	6ES7331-7PF11-0AB0
8 inputs in 4 channel groups Redundancy optional (channel-granular redundancy) <ul style="list-style-type: none"> Resolution 15 bit + sign Fast module cycle (min. 10 ms for 4 channels) Current measurement 0/4 ... 20 mA, ±20 mA (8 channels, 2 wires with external supply or 4 wires) Voltage measurement 1 ... 5 V, ±5 V, ±10 V (8 channels) Wire break monitoring with 4 ... 20 mA and 1 ... 5 V, ±5 V, ±10 V Short-circuit-proof Electrical isolation between channel groups Internal module diagnostics Front connector required: 40-pin 	6ES7331-7NF10-0AB0	6 inputs in 6 channel groups Redundancy optional (channel-granular redundancy) <ul style="list-style-type: none"> Resolution 15 bit + sign Electrical isolation up to 250 V AC between the channels Measuring mode (temperature or voltage) and measuring range adjustable per channel Temperature measurement with thermocouple type B, C, N, E, R, S, J, L, T, K, U, TxK/ XK (L); internal compensation; external compensation possible with Pt100 Voltage measurement 25 mV, ±50 mV, ±80 mV, ±250 mV, ±500 mV, ±1 V Input impedance 10 MΩ each Programmable diagnostics and diagnostics alarm Programmable process alarm on limit violation Calibration possible using SIMATIC PDM Front connector required: 40-pin 	6ES7331-7PE10-0AB0

SIMATIC PCS 7 system hardware

Process I/O

SIMATIC ET 200M for SIMATIC PCS 7

Analog modules**Ordering data****Article No.****Article No.****Analog output modules****SM 332 modules for current and voltage outputs****2 outputs in 2 channel groups**

- Resolution 12 bit/11 bit + sign
- Voltage 1 ... 5 V, 0 ... 10 V; ± 10 V (2 channels; 2 or 4 wires)
- Current 0/4 ... 20 mA; ± 20 mA (2 channels; 2 wires)
- Configurable substitute value output in case of CPU stop
- Wire break monitoring (only for current)
- Short circuit monitoring (only for voltage)
- Internal module diagnostics
- Front connector required: 20-pin

6ES7332-5HB01-0AB0**4 outputs in 4 channel groups
Redundancy optional**

- (channel-granular redundancy)
- Resolution 12 bit/11 bit + sign
- Voltage 1 ... 5 V, 0 ... 10 V, ± 10 V (4 channels; 4 wires)
- Current 0/4 ... 20 mA; ± 20 mA (4 channels; 2 wires)
- Configurable substitute value output in case of CPU stop
- Wire break monitoring (only for current)
- Short circuit monitoring (only for voltage)
- Internal module diagnostics
- Front connector required: 20-pin

6ES7332-5HD01-0AB0**8 outputs in 8 channel groups
Optional redundancy**

- (channel-granular redundancy)
- Resolution 12 bit/11 bit + sign
- Voltage 1 ... 5 V, 0 ... 10 V, ± 10 V (8 channels; 4 wires)
- Current 0/4 ... 20 mA; ± 20 mA (8 channels; 2 wires)
- Configurable substitute value output in case of CPU stop
- Wire break monitoring (only for current)
- Short circuit monitoring (only for voltage)
- Internal module diagnostics
- Front connector required: 40-pin

6ES7332-5HF00-0AB0**4 outputs in 4 channel groups**

- Resolution 14/15/16 bit
- Voltage 1 ... 5 V, 0 ... 10 V, ± 10 V (4 channels; 4 wires)
- Current 0/4 ... 20 mA; ± 20 mA (4 channels; 2 wires)
- Configurable substitute value output in case of CPU stop
- Isolated by channel
- Internal module diagnostics
- Front connector required: 20-pin

6ES7332-7ND02-0AB0

Overview



The modules with HART which can be used in ET 200M remote I/O stations (with IM 153-2 High Feature interface module) permit connection of HART devices to the SIMATIC PCS 7 automation system.

Transmitters and HART actuators that are certified for digital communication with the HART protocol can be connected through these modules.

With 0/4 to 20 mA technology, conventional transmitters/actuators without HART protocol can also be connected.

All modules with HART come with diagnostics capability (channel and module diagnostics). The diagnostics and monitoring functions are directly available in SIMATIC PCS 7. They require no additional engineering. Plain text messages output on the operator station provide information on faults or changes in the HART parameter settings.

Homogenous integration in the SIMATIC Process Device Manager (PDM) and the PCS 7 Asset Management permit intuitive online diagnostics and parameterization of all connected field devices from a central position.

Function

HART is a serial transmission procedure with which additional parameter data such as measuring ranges, attenuation etc. can be sent to transmitters and actuators over a 4 to 20-mA current loop. The HART jobs for each channel can be remotely initiated over the PROFIBUS DP. This usually takes place from the central engineering system of the SIMATIC PCS 7 process control system per SIMATIC PDM.

The modules with HART have the following features:

- Connections compatible with the conventional analog modules of the ET 200M
- Additional communications possibility over the current loop
- Up to 8 analog channels per module (2 analog channels with Ex modules; 6 analog channels with safety-related SM 336 F-AI HART module)
- Each channel is a primary master of the HART protocol
- Selectable input range per channel (AI):
 - 0 to 20 mA (without HART function)
 - \pm 20 mA (without HART function, not with Ex module or SM 336 F-AI HART module)
 - 4 to 20 mA (with/without HART function)
- Selectable output range per channel (AO):
 - 0 to 20 mA (with/without HART function; in the case of Ex module, only without HART function)
 - 4 to 20 mA (with/without HART function)

Additional functions of the 6ES7331-7TF01-0AB0 and 6ES7332-8TF01-0AB0 HART analog modules:

- Supplementary HART variables (up to 4 per channel, up to 8 per module) allow the transmission of additional values from/to the HART devices
- Modules can be used redundant (channel-granular redundancy)

Additional functions of the SM 336 F-AI HART module:

- Modules can be used redundant (channel-granular redundancy)
- HART communication can be activated safety-related in online mode, or switched off

Parameterization

- For the analog input modules (AI), it is possible to parameterize e.g. conversion time, input range, limits, alarms, smoothing of measured values
- For the analog output modules (AO), it is possible to parameterize e.g. output range, response on stoppage of AS (CPU), diagnostics
- Remote parameterization (per PROFIBUS DP) of the HART transmitters and actuators with SIMATIC PDM
- It is still possible to parameterize the HART devices using an operator terminal (handheld).

SIMATIC PCS 7 system hardware

Process I/O

SIMATIC ET 200M for SIMATIC PCS 7

Analog modules with HART

Ordering data	Article No.		Article No.
Analog input module SM 331 HART Redundancy optional (channel-granular redundancy) 8 inputs, 0/4 ... 20 mA or ±20 mA <ul style="list-style-type: none"> Resolution: 15 bit + sign Connection of 2-wire or 4-wire transmitters possible HART (2-wire or 4-wire) Wire break monitoring Short-circuit-proof Front connector required: 20-pin 	6ES7331-7TF01-0AB0	SM 331 HART Ex analog input module [EEx ib] 2 inputs, 0/4 ... 20 mA in 2 channel groups, as of HART revision 5.0 <ul style="list-style-type: none"> Individual electrically isolated channels Resolution: 15 bit + sign Connection of 2-wire or 4-wire transmitters possible Wire break monitoring Short-circuit-proof HART (2-wire or 4-wire) Front connector required: 20-pin 	6ES7331-7TB10-0AB0
Analog output module SM 332 HART Redundancy optional (channel-granular redundancy) 8 outputs, 0/4 ... 20 mA <ul style="list-style-type: none"> Resolution: 15 bit + sign For 2-wire actuators HART (2-wire) Wire break monitoring Front connector required: 20-pin 	6ES7332-8TF01-0AB0	SM 332 HART Ex analog output module [EEx ib] 2 outputs, 0/4 ... 20 mA in 2 channel groups, as of HART revision 5.0 <ul style="list-style-type: none"> Individual electrically isolated channels Resolution: 12 bit + sign For 2-wire actuators Wire break monitoring HART Front connector required: 20-pin 	6ES7332-5TB10-0AB0
		SM 336 F-AI HART safety-related analog input module Redundancy optional (channel-granular redundancy) 6 inputs, 0/4 ... 20 mA	For detailed ordering data, see the section "F digital/analog modules"

Technical specifications

Article number	6ES7331-7TF01-0AB0	6ES7331-7TB10-0AB0
	SM331, 8AI, 0/4-20MA HART	SIMATIC DP, HART ANALOG INPUT M
Supply voltage		
Load voltage L+		
• Rated value (DC)	24 V	24 V
Input current		
from load voltage L+ (without load), max.	20 mA	180 mA
from backplane bus 5 V DC, max.	120 mA	100 mA
Output voltage		
Power supply to the transmitters		
• present	Yes	Yes
• Rated value (DC)	24 V	15 V; at 22 mA
• short-circuit proof	Yes	Yes; approx. 30 mA
• No-load voltage (DC)		29.6 V
• Supply current, max.	60 mA	
Power loss		
Power loss, typ.	1.5 W	4.5 W
Analog inputs		
Number of analog inputs	8	2
permissible input current for current input (destruction limit), max.	40 mA	40 mA
Input ranges (rated values), currents		
• 0 to 20 mA	Yes	Yes
• 4 mA to 20 mA		Yes
Cable length		
• shielded, max.	800 m	400 m

Technical specifications (continued)

Article number	6ES7331-7TF01-0AB0 SM331, 8AI, 0/4-20mA HART	6ES7331-7TB10-0AB0 SIMATIC DP, HART ANALOG INPUT M
Analog value generation for the inputs		
Measurement principle	Sigma Delta	Sigma Delta
Integration and conversion time/resolution per channel		
<ul style="list-style-type: none"> Resolution with overrange (bit including sign), max. Integration time, parameterizable Integration time (ms) Basic conversion time, including integration time (ms) Interference voltage suppression for interference frequency f_1 in Hz 	16 bit Yes 20 ms at 50 Hz; 16.6 ms at 60 Hz; 100 ms at 100 Hz 55 ms @ 60 Hz, 65 ms @ 50 Hz, 305 ms @ 100 Hz 10 / 50 / 60 Hz	16 bit; 10 bit to 15 bit + sign Yes 2.5 / 16.67 / 20 / 100 (1 channel enabled); 7.5 / 50 / 60 / 300 (2 channels enabled)
Smoothing of measured values		
<ul style="list-style-type: none"> parameterizable 	Yes	
Encoder		
Connection of signal encoders		
<ul style="list-style-type: none"> for current measurement as 2-wire transducer for current measurement as 4-wire transducer 	Yes Yes	Yes Yes
Errors/accuracies		
Operational error limit in overall temperature range		
<ul style="list-style-type: none"> Current, relative to input range, (+/-) 	0.15 %	0.45 %; From 0/4 to 20 mA
Basic error limit (operational limit at 25 °C)		
<ul style="list-style-type: none"> Current, relative to input range, (+/-) 	0.1 %	0.1 %; From 0/4 to 20 mA
Interrupts/diagnostics/status information		
Diagnostics function	Yes	Yes; Parameterizable
Alarms		
<ul style="list-style-type: none"> Diagnostic alarm Limit value alarm 	Yes Yes	Yes; Parameterizable Yes; Parameterizable, channels 0 and 1
Ex(i) characteristics		
Module for Ex(i) protection		Yes
Maximum values for connecting terminals for gas group IIC		
<ul style="list-style-type: none"> U_0 (no-load voltage), max. I_0 (short-circuit current), max. P_0 (power output), max. C_0 (permissible external capacity), max. L_0 (permissible external inductivity), max. U_m (voltage at non-intrinsically safe connecting terminals), max. 		26 V 96.1 mA 511 mW 62 nF 3 mH 250 V; DC

SIMATIC PCS 7 system hardware

Process I/O

SIMATIC ET 200M for SIMATIC PCS 7

Analog modules with HART**Technical specifications (continued)**

Article number	6ES7331-7TF01-0AB0 SM331, 8AI, 0/4-20MA HART	6ES7331-7TB10-0AB0 SIMATIC DP, HART ANALOG INPUT M
Standards, approvals, certificates		
CE mark		Yes
UL approval		Yes
FM approval		Yes
RCM (formerly C-TICK)		Yes
KC approval		Yes
EAC (formerly Gost-R)		Yes
Use in hazardous areas		
• Type of protection acc. to FM		Class I, Division 2, Group A, B, C, D T4; Class I, Zone 2, Group IIC T4
• Test number KEMA		DEKRA 14 ATEX 0052X
Ambient conditions		
Ambient temperature during operation		
• min.		0 °C
• max.		60 °C
Connection method		
required front connector	20-pin	1x 20-pin
Dimensions		
Width	40 mm	40 mm
Height	125 mm	125 mm
Depth	117 mm	120 mm
Weights		
Weight, approx.	205 g	260 g
Article number	6ES7332-8TF01-0AB0 SM332, 8AO, 0/4 - 20MA HART	6ES7332-5TB10-0AB0 SIMATIC DP, HART ANALOG OUTPUT
Supply voltage		
Load voltage L+		
• Rated value (DC)	24 V	24 V
Input current		
from load voltage L+ (without load), max.	350 mA	150 mA
from backplane bus 5 V DC, max.	110 mA	100 mA
Power loss		
Power loss, typ.	6 W	3.5 W
Analog outputs		
Number of analog outputs	8	2
Current output, no-load voltage, max.	24 V	19 V
Cycle time (all channels) max.		5 ms
Output ranges, current		
• 0 to 20 mA	Yes	Yes
• -20 mA to +20 mA	No	No
• 4 mA to 20 mA	Yes	Yes
Connection of actuators		
• for current output two-wire connection	Yes	Yes
Load impedance (in rated range of output)		
• with current outputs, max.	750 Ω	650 Ω
• with current outputs, inductive load, max.	10 mH	7.5 mH
Cable length		
• shielded, max.	800 m	400 m

Technical specifications (continued)

Article number	6ES7332-8TF01-0AB0 SM332, 8AO, 0/4 - 20MA HART	6ES7332-5TB10-0AB0 SIMATIC DP, HART ANALOG OUTPUT
Analog value generation for the outputs		
Integration and conversion time/resolution per channel		
<ul style="list-style-type: none"> Resolution with overrange (bit including sign), max. Conversion time (per channel) Basic execution time of the module (all channels released) 	16 bit 10 ms; 10 ms in AO mode 50 ms in HART-AO mode	12 bit; + sign 40 ms
Settling time		
<ul style="list-style-type: none"> for resistive load for capacitive load for inductive load 	0.1 ms 0.5 ms	2.5 ms 4 ms 2.5 ms
Errors/accuracies		
Operational error limit in overall temperature range		
<ul style="list-style-type: none"> Current, relative to output range, (+/-) 	0.2 %	0.55 %
Basic error limit (operational limit at 25 °C)		
<ul style="list-style-type: none"> Current, relative to output range, (+/-) 	0.1 %	0.15 %
Interrupts/diagnostics/status information		
Diagnostics function	Yes	Yes; Parameterizable
Alarms		
<ul style="list-style-type: none"> Diagnostic alarm 	Yes	Yes; Parameterizable
Ex(i) characteristics		
Module for Ex(i) protection		Yes
Maximum values for connecting terminals for gas group IIC		
<ul style="list-style-type: none"> Uo (no-load voltage), max. Io (short-circuit current), max. Po (power output), max. Co (permissible external capacity), max. Lo (permissible external inductivity), max. Um (voltage at non-intrinsically safe connecting terminals), max. 		19 V 66 mA 506 mW 230 nF 7.5 mH 60 V; DC
Standards, approvals, certificates		
FM approval		Yes
Use in hazardous areas		
<ul style="list-style-type: none"> Type of protection acc. to FM Test number KEMA 		Class I, Division 2, Group A, B, C, D T4; Class I, Zone 2, Group IIC T4 DEKRA 14 ATEX 0053X
Ambient conditions		
Ambient temperature during operation		
<ul style="list-style-type: none"> max. 		60 °C
Connection method		
required front connector	20-pin	20-pin
Dimensions		
Width	40 mm	40 mm
Height	125 mm	125 mm
Depth	117 mm	120 mm
Weights		
Weight, approx.	220 g	290 g

SIMATIC PCS 7 system hardware

Process I/O

SIMATIC ET 200M for SIMATIC PCS 7

Ex digital/analog modules

Overview



The following analog and digital input and output modules are suitable for use in hazardous plants. They separate the non-intrinsically safe electrical circuits of the automation system and the intrinsically safe electrical circuits of the process. Sensors and actuators suitable for placing in zone 1 or 21 and 2 or 22 hazardous areas as well as intrinsically safe equipment compliant with DIN 50020 and [Ex ib] IIC can be operated on these modules.

All Ex modules come with diagnostics capability (channel and module diagnostics).

If hazardous area modules are marked as being capable of redundancy (6ES7321-7RD00-0AB0, 6ES7322-5SD00-0AB0, 6ES7331-7RD00-0AB0, 6ES7332-5RD00-0AB0), they can also be operated redundantly in non-hazardous areas.

Ordering data

Article No.

Article No.

Ex digital input modules

- 4 NAMUR inputs in 4 channel groups**
Redundancy optional
 (channel-granular redundancy)
- Voltage supply to sensors 8.2 V
 - Individual electrically isolated channels
 - Time stamping in association with IM 153-2 High Feature, accuracy 10 ms, rising or falling edge, can be configured channel-granular
 - Wire break and short-circuit monitoring (directly at the contact for contacts with external resistor circuit)
 - Internal module diagnostics
 - Front connector required: 20-pin

6ES7321-7RD00-0AB0

Ex digital output modules

- 4 outputs, 24 V DC, 10 mA in 4 channel groups**
Redundancy optional
 (channel-granular redundancy)
- Individual electrically isolated channels
 - Wire break monitoring
 - Short-circuit monitoring
 - Internal module diagnostics
 - Front connector required: 20-pin

6ES7322-5SD00-0AB0

4 outputs, 15 V DC / 20 mA in 4 channel groups

- Individual electrically isolated channels
- Wire break monitoring
- Short-circuit monitoring
- Internal module diagnostics
- Front connector required: 20-pin

6ES7322-5RD00-0AB0

Ex analog input modules

- 4 inputs, 0/4 ... 20 mA in 4 channel groups**
Redundancy optional
 (channel-granular redundancy)
- Individual electrically isolated channels
 - Resolution 15 bit + sign
 - Connection of 2-wire or 4-wire transmitters possible
 - Wire break monitoring
 - Measurement range monitoring
 - Short-circuit-proof
 - Internal module diagnostics
 - Front connector required: 20-pin

6ES7331-7RD00-0AB0

- 8 inputs in 4 channel groups**
- Resolution 15 bit + sign
 - Thermocouples type T, U, E, J, L, K, N, R, S, B (8 channels)
 Internal compensation; external compensation with Pt100 (2 channels), compensating box or 0/50 °C cold junction
 - Resistance thermometer Pt100, Pt200, Ni100 (4 channels; 2-wire or 4-wire, 3-wire Pt100 on request)
 - Wire break monitoring
 - Internal module diagnostics
 - Front connector required: 20-pin

6ES7331-7SF00-0AB0

Note:

A special front connector for the Ex analog input module 6ES7331-7SF00-0AB0 enables greater accuracy when making thermocouple temperature measurements in "Internal compensation" measuring mode (see the section "Accessories").

Ex analog output modules

- 4 outputs, 0/4 ... 20 mA in 4 channel groups**
Redundancy optional
 (channel-granular redundancy)
- Individual electrically isolated channels
 - Resolution 15 bit
 - For 2-wire transmitters
 - Wire break monitoring
 - Internal module diagnostics
 - Front connector required: 20-pin

6ES7332-5RD00-0AB0

For additional Ex modules, refer to the "Analog modules with HART" section.

Technical specifications

Article number	6ES7321-7RD00-0AB0 SM321, 4DI, DC24V, HAZARDOUS AREAS
Supply voltage	
Load voltage L+	
• Rated value (DC)	24 V
Input current	
from load voltage L+ (without load), max.	50 mA
from backplane bus 5 V DC, max.	80 mA
Power loss	
Power loss, typ.	1.1 W
Digital inputs	
Number of digital inputs	4
Number of NAMUR inputs	4
Input voltage	
• Type of input voltage	DC
• Rated value (DC)	8.2 V; from internal power circuit supply
Input current	
• on wire-break, max.	0.1 mA
• on short-circuit, max.	8.5 mA
for NAMUR encoders	
- for signal "0"	0.35 to 1.2 mA
- for signal "1"	2.1 to 7 mA
Input delay (for rated value of input voltage)	
• Input frequency (with a time delay of 0.1 ms), max.	2 kHz
for NAMUR inputs	
- parameterizable	Yes; 0.1 / 0.5 / 3 / 15 / 20 ms (plus 0.25 ms preparation time)
Encoder	
Connectable encoders	
• NAMUR encoder	Yes; Two-wire connection

Article number	6ES7321-7RD00-0AB0 SM321, 4DI, DC24V, HAZARDOUS AREAS
Interrupts/diagnostics/status information	
Diagnostics function	Yes
Ex(i) characteristics	
Module for Ex(i) protection	Yes
Maximum values for connecting terminals for gas group IIC	
• U _o (no-load voltage), max.	10 V
• I _o (short-circuit current), max.	14.1 mA
• P _o (power output), max.	33.7 mW
• C _o (permissible external capacity), max.	3 µF
• L _o (permissible external inductivity), max.	100 mH
Standards, approvals, certificates	
Use in hazardous areas	
• Type of protection acc. to EN 50020 (CENELEC)	[EEx ib] IIC
• Type of protection acc. to FM	Class II, Division 2, Group A, B, C, D T4
• Test number PTB	Ex-96.D.2094X
Ambient conditions	
Ambient temperature during operation	
• max.	60 °C
Connection method	
required front connector	20-pin
Dimensions	
Width	40 mm
Height	125 mm
Depth	120 mm
Weights	
Weight, approx.	230 g

Article number	6ES7322-5SD00-0AB0 SM322, 4DO, 24V DC, 10MA, HAZARDOUS AREAS	6ES7322-5RD00-0AB0 SM322, 4DO, 15V DC, 20MA, HAZARDOUS AREAS
Supply voltage		
Load voltage L+		
• Rated value (DC)	24 V	24 V
Input current		
from load voltage L+ (without load), max.	160 mA	160 mA
from backplane bus 5 V DC, max.	85 mA	85 mA
Power loss		
Power loss, typ.	3 W	3 W
Digital outputs		
Number of digital outputs	4	4
Short-circuit protection	Yes; Electronic	Yes; Electronic
Load resistance range		
• upper limit	390 Ω; Two-wire connection	200 Ω; Two-wire connection
Output voltage		
• Rated value (DC)	24 V	15 V
Switching frequency		
• with resistive load, max.	100 Hz	100 Hz
Interrupts/diagnostics/status information		
Diagnostics function	Yes	Yes

SIMATIC PCS 7 system hardware

Process I/O

SIMATIC ET 200M for SIMATIC PCS 7

Ex digital/analog modules**Technical specifications (continued)**

Article number	6ES7322-5SD00-0AB0 SM322, 4DO, 24V DC, 10MA, HAZARDOUS AREAS	6ES7322-5RD00-0AB0 SM322, 4DO, 15V DC, 20MA, HAZARDOUS AREAS
Ex(i) characteristics		
Module for Ex(i) protection	Yes	Yes
Maximum values for connecting terminals for gas group IIC		
• U _o (no-load voltage), max.	25.2 V	15.75 V
• I _o (short-circuit current), max.	70 mA	85 mA
• P _o (power output), max.	440 mW	335 mW
• C _o (permissible external capacity), max.	90 nF	500 nF
• L _o (permissible external inductivity), max.	6.7 mH	5 mH
Standards, approvals, certificates		
Use in hazardous areas		
• Type of protection acc. to EN 50020 (CENELEC)	[Ex ib] IIC	[Ex ib] IIC
• Type of protection acc. to FM	Class I, Division 2, Group A, B, C, D T4	AIS CL.1, DIV 1, GP A, B, C, D; CL.I, DIV 2, GP A, B, C, D T4
• Test number PTB	Ex-96.D.2093X	Ex-96.D.2102X
Ambient conditions		
Ambient temperature during operation		
• max.	60 °C	60 °C
Connection method		
required front connector	20-pin	20-pin
Dimensions		
Width	40 mm	40 mm
Height	125 mm	125 mm
Depth	120 mm	120 mm
Weights		
Weight, approx.	230 g	230 g
Article number	6ES7331-7RD00-0AB0 SIMATIC S7, SM 331 ANALOG INPUT	6ES7331-7SF00-0AB0 SIMATIC S7, SM 331 ANALOG INPUT
Supply voltage		
Load voltage L+		
• Rated value (DC)	24 V	24 V
Input current		
from load voltage L+ (without load), max.	250 mA	
from backplane bus 5 V DC, max.	60 mA	120 mA
Output voltage		
Power supply to the transmitters		
• Rated value (DC)	13 V; at 22 mA	
Power loss		
Power loss, typ.	3 W	0.6 W
Analog inputs		
Number of analog inputs	4	8; 8x thermocouples; 4x RTD thermoresistors
permissible input current for current input (destruction limit), max.	40 mA	
Input ranges (rated values), voltages		
• -1 V to +1 V		Yes
• -25 mV to +25 mV		Yes
• -250 mV to +250 mV		Yes
• -50 mV to +50 mV		Yes
• -500 mV to +500 mV		Yes
• -80 mV to +80 mV		Yes
Input ranges (rated values), currents		
• 0 to 20 mA	Yes	
• 4 mA to 20 mA	Yes	

Technical specifications (continued)

Article number	6ES7331-7RD00-0AB0 SIMATIC S7, SM 331 ANALOG INPUT	6ES7331-7SF00-0AB0 SIMATIC S7, SM 331 ANALOG INPUT
Input ranges (rated values), thermocouples		
• Type B		Yes
• Type E		Yes
• Type J		Yes
• Type K		Yes
• Type L		Yes
• Type N		Yes
• Type R		Yes
• Type S		Yes
• Type T		Yes
• Type U		Yes
Input ranges (rated values), resistance thermometer		
• Ni 100		Yes
• Pt 100		Yes
• Pt 200		Yes
Cable length		
• shielded, max.	200 m	200 m; TC: 50 m
Analog value generation for the inputs		
Integration and conversion time/resolution per channel		
• Resolution with overrange (bit including sign), max.	16 bit; 10 bit to 15 bit + sign	16 bit; 10 bit to 15 bit + sign
• Integration time, parameterizable	Yes; 2.5 to 100 ms	Yes; 2.5 to 100 ms
• Interference voltage suppression for interference frequency f_1 in Hz	10 to 400 Hz	10 to 400 Hz
Encoder		
Connection of signal encoders		
• for current measurement as 2-wire transducer	Yes	Yes
• for current measurement as 4-wire transducer	Yes	Yes
Errors/accuracies		
Operational error limit in overall temperature range		
• Current, relative to input range, (+/-)	0.45 %	
• Resistance thermometer, relative to input range, (+/-)		0.04 %; 0.09 to 0.04%
Basic error limit (operational limit at 25 °C)		
• Current, relative to input range, (+/-)	0.1 %	
• Resistance thermometer, relative to input range, (+/-)		0.008 %; 0.018 ... 0.008%
Interrupts/diagnostics/status information		
Diagnostics function	Yes	Yes
Ex(i) characteristics		
Module for Ex(i) protection	Yes	Yes
Maximum values for connecting terminals for gas group IIC		
• U_0 (no-load voltage), max.	25.2 V	5.9 V
• I_0 (short-circuit current), max.	68.5 mA	28.8 mA
• P_0 (power output), max.	431 mW	41.4 mW
• C_0 (permissible external capacity), max.	90 nF	43 μ F
• L_0 (permissible external inductivity), max.	7.5 mH	40 mH

SIMATIC PCS 7 system hardware

Process I/O

SIMATIC ET 200M for SIMATIC PCS 7

Ex digital/analog modules

Technical specifications (continued)

Article number	6ES7331-7RD00-0AB0 SIMATIC S7, SM 331 ANALOG INPUT	6ES7331-7SF00-0AB0 SIMATIC S7, SM 331 ANALOG INPUT
Standards, approvals, certificates		
Use in hazardous areas		
• Type of protection acc. to EN 50020 (CENELEC)	[EEx ib] IIC	[EEx ib] IIC
• Type of protection acc. to FM	Class I, Division 2, Group A, B, C, D T4	Class I, Division 2, Group A, B, C, D T4
• Test number PTB	Ex-96.D.2092X	Ex-96.D.2108X
Ambient conditions		
Ambient temperature during operation		
• max.	60 °C	60 °C
Connection method		
required front connector	20-pin	20-pin
Dimensions		
Width	40 mm	
Height	125 mm	
Depth	120 mm	
Weights		
Weight, approx.	290 g	210 g

Article number	6ES7332-5RD00-0AB0 SIMATIC S7, SM 332 ANALOG OUTPUT
Supply voltage	
Load voltage L+	
• Rated value (DC)	24 V
Input current	
from load voltage L+ (without load), max.	200 mA
from backplane bus 5 V DC, max.	80 mA
Power loss	
Power loss, typ.	4 W
Analog outputs	
Number of analog outputs	4
Voltage output, short-circuit protection	Yes
Voltage output, short-circuit current, max.	70 mA
Current output, no-load voltage, max.	14 V
Output ranges, current	
• 0 to 20 mA	Yes
• 4 mA to 20 mA	Yes
Load impedance (in rated range of output)	
• with current outputs, max.	500 Ω
Cable length	
• shielded, max.	200 m
Analog value generation for the outputs	
Integration and conversion time/resolution per channel	
• Resolution with overrange (bit including sign), max.	15 bit
Errors/accuracies	
Operational error limit in overall temperature range	
• Current, relative to output range, (+/-)	0.55 %
Basic error limit (operational limit at 25 °C)	
• Current, relative to output range, (+/-)	0.2 %

Article number	6ES7332-5RD00-0AB0 SIMATIC S7, SM 332 ANALOG OUTPUT
Interrupts/diagnostics/status information	
Diagnostics function	Yes
Ex(i) characteristics	
Module for Ex(i) protection	Yes
Maximum values for connecting terminals for gas group IIC	
• U _o (no-load voltage), max.	14 V
• I _o (short-circuit current), max.	70 mA
• P _o (power output), max.	440 mW
• C _o (permissible external capacity), max.	850 nF
• L _o (permissible external inductivity), max.	6.6 mH
Standards, approvals, certificates	
Use in hazardous areas	
• Type of protection acc. to EN 50020 (CENELEC)	[EEx ib] IIC
• Type of protection acc. to FM	Class I, Division 2, Group A, B, C, D T4
• Test number PTB	Ex-96.D.2026X
Ambient conditions	
Ambient temperature during operation	
• max.	60 °C
Connection method	
required front connector	20-pin
Dimensions	
Width	40 mm
Height	125 mm
Depth	120 mm
Weights	
Weight, approx.	280 g

Overview



The safety functions of the safety-related automation systems are matched to the safety-related I/O modules (F-modules) of the ET 200M distributed I/O system. The F-signal modules (DI/DO/AI) in the ET 200M remote I/O stations comply with safety requirements up to SIL 3 (IEC 61508). They can diagnose both internal and external faults. To this end, they carry out self-tests, e.g. for short-circuit or open-circuit, and automatically monitor the discrepancy time defined in the parameter settings. They are able to guarantee plant safety even if there is a CPU failure in the automation system.

Depending on the version, the input modules support 1oo1 and 1oo2 evaluation on the module. 2oo3 evaluation of three sensors is possible using the corresponding voter block (component of the S7 F block library) within the safety program.

In the event of a faulty output, the digital output modules allow a safe shutdown via a second shutdown path.

Note:

The SM 326 F-DI NAMUR digital input module, Article No. 6ES7326-1RF01-0AB0, does not support PROFINET.

Design

SM 336 F-AI HART analog input module

The safety-related SM 336 F-AI HART analog input module has 6 inputs for current measurements in the range from 0 to 20 mA or 4 to 20 mA, all of which are designed for SIL 3. The compact width of 40 mm means that a relatively high packing density can be achieved for F modules, allowing a design which saves space and costs.

The module can also handle HART communication with appropriate HART field devices. HART communication can be activated safety-related in online mode, or switched off.

Digital output module SM 326 F-DO

The 40-mm wide safety-related SM 326 F-DO digital output module with 10 outputs (24 V DC, 2 A) and parameterizable redundancy extends the range of compact F-modules commenced with the SM 336 F-AI HART. The module features short response times, and can be used in SIL 3 applications even without an isolating module. It supports the "Keep last valid value" function as well as channel-selective passivation.

Options

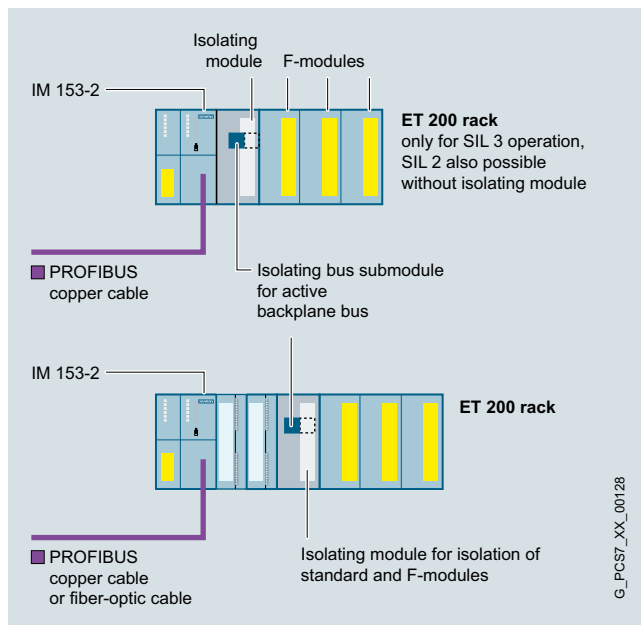

Isolating module

The following components are available as accessories for the F modules:

- Isolating module
 - Isolation of F and standard modules in an ET 200M remote I/O station
 - Signal isolation when using a copper bus connection (only F modules in an ET 200M remote I/O station with IM 153-2)
- Isolating bus submodule for isolating module, when using an active backplane bus

The isolating module is required in SIL 3 applications with F signal modules SM 326; AI 6 x 13 bit, SM 326; DI 8 x NAMUR and SM 326; DO 10 x DC 24 V/2 A (width 80 mm) in the following cases:

- Design of PROFIBUS DP with copper cables
- Design of PROFIBUS DP with fiber-optic cables and joint operation of the mentioned F signal modules with standard modules in an ET 200M station

Note:

The isolating module for F modules and the isolating bus submodule can only be used together. The 40-mm wide gap cannot be used for other modules.

SIMATIC PCS 7 system hardware

Process I/O

SIMATIC ET 200M for SIMATIC PCS 7

Fail-safe digital/analog modules

Ordering data	Article No.		Article No.
SM 326 F-DI safety-related digital input module for floating contacts			
24 inputs, 24 V DC 80 mm wide Isolated in groups of 12 Redundancy optional (channel-granular redundancy) <ul style="list-style-type: none"> • 4 short-circuit-proof sensor power supplies, each for 6 channels, isolated in groups of 3 • External sensor power supply possible • SIL 2: 1oo1 evaluation, 24 channels • SIL 3: 1oo2 evaluation on the module, 12 channels (adjustable discrepancy time) • SIL 3 achievable without isolating module • Short-circuit monitoring to L+ • Discrepancy monitoring • Supports 20 ms time stamping (SOE) • Module internal diagnostics • PROFIsafe telegram • Front connector required: 40-pin 	6ES7326-1BK02-0AB0	8 outputs, 24 V DC, 2 A 80 mm wide Electrically isolated in groups of 4 <ul style="list-style-type: none"> • SIL 2, SIL 3 configurable (8 channels) • SIL 3 achievable without isolating module • P/M-switching (for floating loads; ground and earth separate) • Wire break and short-circuit monitoring • Module internal diagnostics • PROFIsafe telegram • Front connector required: 40-pin 	6ES7326-2BF41-0AB0
8 inputs, NAMUR [EE ex ib]¹⁾ 80 mm wide Isolated by channel Redundancy optional (channel-granular redundancy) <ul style="list-style-type: none"> • 8 short-circuit-resistant sensor power supplies, each for 1 channel, mutually isolated • SIL 2: 1oo1 evaluation, 8 channels • SIL 3: 1oo2 evaluation on the module, 4 channels (adjustable discrepancy time) • Wire break and short-circuit monitoring (for contacts with external resistor circuit) • Discrepancy monitoring • Module internal diagnostics • PROFIsafe telegram • Front connector required: 40-pin 	6ES7326-1RF01-0AB0	SM 336 FA-I HART safety-related analog input module 6 inputs, 0 ... 20 mA or 4 ... 20 mA 40 mm wide Electrically isolated in groups of 3 Redundancy optional (channel-granular redundancy) <ul style="list-style-type: none"> • Resolution: 15 bits + sign • 2-wire or 4-wire connection • 6 short-circuit-proof sensor supplies for 1 channel each • External sensor power supply possible • SIL 3: 1oo1 evaluation (6 channels) and 1oo2 evaluation (3 channels) on the module • SIL 3 achievable without isolating module • Discrepancy monitoring with 1oo2 evaluation (adjustable discrepancy time) • Wire break monitoring • Module and channel diagnostics • HART communication in measuring range 4 ... 20 mA (can be switched on/off online) • HART status display • PROFIsafe telegram • Front connector required: 20-pin 	6ES7336-4GE00-0AB0
Safety-related digital output module SM 326 F-DO Suitable for solenoid valves, DC contactors and indicator lights		Options	
10 outputs, 24 V DC, 2 A 40 mm wide Isolated in groups of 5 (outputs with internal diode) Redundancy optional (channel-granular redundancy) <ul style="list-style-type: none"> • 10 outputs, isolated in groups of 5 • SIL 3 achievable without isolating module • P/P-switching (for non-floating loads; ground and earth connected together) • Wire break and short-circuit monitoring • Configurable diagnostics • "Keep last valid value" parameter • Channel-selective passivation • PROFIsafe telegram • Front connector required: 40-pin 	6ES7326-2BF10-0AB0	Isolating module For F modules, 40 mm wide <ul style="list-style-type: none"> • For isolation of F and standard modules in an ET 200M rack • For signal isolation when using a copper bus connection (only F modules in a rack with IM 153-2) 	6ES7195-7KF00-0XA0
		Isolating bus module 80 mm wide, for isolating module, when using an active backplane bus	6ES7195-7HG00-0XA0

¹⁾ The SM 326 F-DI NAMUR module does not support PROFINET

Overview



The FM 355 is an intelligent 4-channel controller module for universal control tasks. It can be used to control temperature, pressure and flow.

The following versions of the FM 355 are available:

- FM 355 C
Continuous-action controller with 4 analog outputs for controlling analog actuators
- FM 355 S
Step or pulse controller with 8 digital outputs for controlling motor-driven (integrating) actuators or binary controlled actuators (e.g. electrical heating strips and cartridges)
- FM 355-2 C/S
Specially optimized for temperature controls with user-friendly online self-optimization integrated

Function

The FM 355 and FM 355-2 modules have four separate control channels. The controllers have the following features:

- Predefined controller structures for
 - Fixed setpoint control
 - Cascade controller
 - Ratio control
 - 3-component control
- Different operating modes
 - Automatic mode
 - Manual mode
 - Safety mode
 - Follow-up mode
 - Backup mode
- Sampling time (depending on the resolution of the analog inputs and the compensation input):
 - At 12 bits: 20 ms to 100 ms (FM 355-2 only)
 - At 14 bits: 100 ms to 500 ms (depending on the number of released analog inputs)
- 2 control algorithms:
 - Self-optimizing temperature control algorithm
 - PID algorithm
- Integrated online self-optimization without configuration (FM 355-2 only)
 - Faster adjustment to the operating point
- Convenient controller optimization
- Backup mode
The controller can continue to control independently in the event of CPU failure or CPU stop. To this end, configurable safety setpoints or safety manipulated variables are set.
- Feed forward control
The analog inputs can optionally be used for feed forward control in addition to actual value recording.

SIMATIC PCS 7 system hardware

Process I/O

SIMATIC ET 200M for SIMATIC PCS 7

Controller modules

Integration

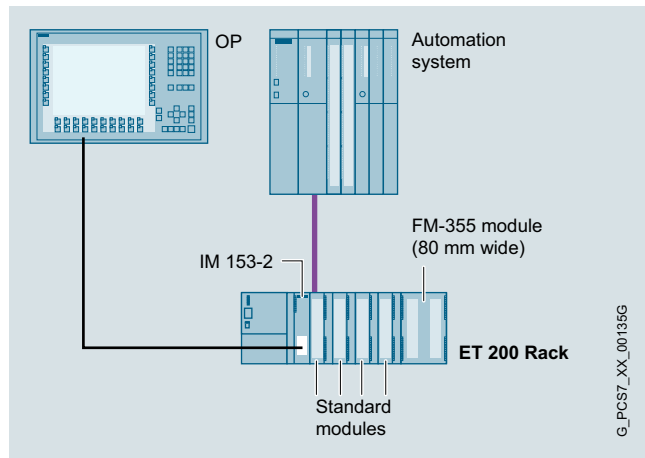

Use in SIMATIC PCS 7

The FM 355/FM 355-2 modules can be used to implement control tasks outside the SIMATIC PCS 7 automation system. The modules have not only controller structures but also analog and digital channels, thus eliminating the need for additional modules to detect the setpoint/actual value or to control the actuator.

On the one hand this reduces the work load for the CPU, on the other hand it enables backup mode with which the control system continues to work even if the CPU fails. In this case the FM 355 module can be operated further with an OP operator panel (does not apply to FM 355-2).

The operator panel is connected to the PROFIBUS DP fieldbus for this purpose. The CPU of the automation system can surrender input privilege to the operator panel in normal operation as well. The parameters that can be accessed with the operator panel are the setpoint and manipulated variable. If the FM 355 module is operated from the operator panel, the automation system reads back the values accessible from the operator panel after the input privilege is withdrawn or recovered again. Bumpless continuation of the operations is thus assured.

IM 153-2 High Feature interface modules are needed for the PROFIBUS DP connection when the FM 355/FM 355-2 controller modules are used in ET 200M.

SIMATIC PCS 7 blocks

CFC blocks with OS faceplates for all FM 355 modules are included in the scope of supply of the standard SIMATIC PCS 7 library (part of engineering software). These blocks are integrated into the SIMATIC PCS 7 driver concept. This guarantees homogenous system integration (including automatic diagnostics messages).

Parameterization in HW-Config

A configuration package containing all parameterization masks required for configuring, parameterizing and commissioning is included in the scope of supply of the FM 355 controller modules.

Ordering data

Article No.

FM 355 C controller module

With 4 analog outputs for 4 continuous-action controllers
Front connector required: 2 x 20-pin
Incl. multi-lingual configuration package, manual and Getting Started (English, German, French, Italian) on CD-ROM

6ES7355-0VH10-0AE0

FM 355 S controller module

With 8 digital outputs for 4 step or pulse controllers
Front connector required: 2 x 20-pin
Incl. multi-lingual configuration package, manual and Getting Started (English, German, French, Italian) on CD-ROM

6ES7355-1VH10-0AE0

FM 355-2 C temperature controller module

with 4 analog outputs for 4 continuous-action controllers
Front connector required: 2 x 20-pin
Incl. multi-lingual configuration package, manual and Getting Started (English, German, French, Italian) on CD-ROM

6ES7355-2CH00-0AE0

FM 355-2 S temperature controller module

With 8 digital outputs for 4 step or pulse controllers
Front connector required: 2 x 20-pin
Incl. multi-lingual configuration package, manual and Getting Started (English, German, French, Italian) on CD-ROM

6ES7355-2SH00-0AE0

Note:

In the case of the FM 355 C and FM 355 S controller modules, the channels are not electrically isolated from one another

Overview



The FM 350-1 counter module is a single-channel intelligent counter module for simple counting tasks, suitable for the direct connection of incremental encoders. It provides a comparison function with 2 preselectable reference values, as well as integrated digital outputs for outputting a reaction upon reaching the reference value.

The FM 350-2 counter module is an eight-channel intelligent counter module for universal counting and measuring tasks, as well as for simple positioning jobs (max. 4 axes).

Ordering data

Article No.

FM 350-1 counter module

Counting functions up to 500 kHz
 1 channel for the connection of 5 V
 and 24 V incremental encoders
 Front connector required: 1 x 20-pin
 incl. configuration package
 on CD-ROM

6ES7350-1AH03-0AE0

FM 350-2 counter module

8 channels with maximum 20 kHz
 counting frequency; for 24 V
 encoders, for the following tasks:
 counting, frequency measurement,
 speed measurement, period
 measurement, dosing

Front connector required: 1 x 40-pin
 incl. configuration package
 on CD-ROM

6ES7350-2AH01-0AE0

SIMATIC PCS 7 system hardware

Process I/O

SIMATIC ET 200M for SIMATIC PCS 7

MTA terminal modules

Overview

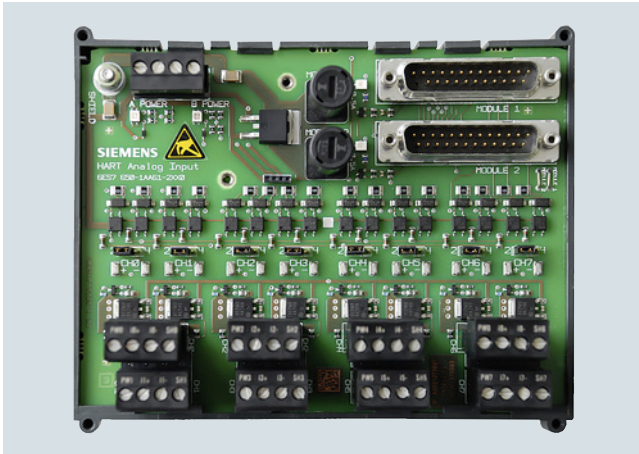

MTA AI HART terminal module, 8-channel

MTA terminal modules (Marshaled Termination Assemblies) can be used to connect field devices, sensors and actuators to the I/O modules of the ET 200M remote I/O stations simply, rapidly and reliably. They can be used to significantly reduce the costs and required work for cabling and commissioning, and prevent wiring errors.

The individual MTA terminal modules are each tailored to specific I/O modules from the ET 200M range (see design for assignment table). MTA versions are available for standard I/O modules as well as for redundant and safety-related I/O modules.

The MTA terminal modules are connected to the I/O modules using 3 m or 8 m long preassembled cables.

The MTA Power Supply 24 V DC terminal module comes with 16 24 V DC, 0.5 A outputs protected against short-circuit for redundant power supply of field devices that are no longer supplied by means of signal lines by some of the newer MTAs, for example 4-wire transmitters. If 0.5 A is insufficient, you can also connect two or more outputs in parallel.

Design

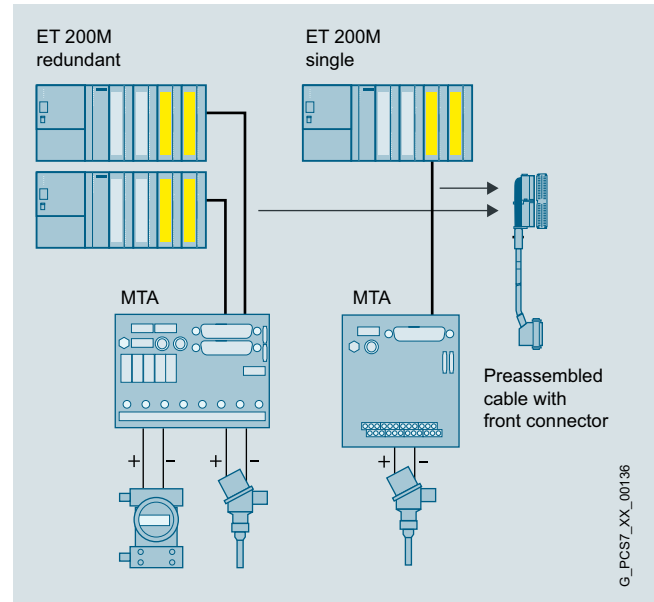

G_PCS7_XX_00136

- MTA terminal modules in versions for standard, redundant and safety-related I/O modules of the ET 200M distributed I/O system
- Redundant 24 V DC supply
- Power Monitor Board for diagnostics of the redundant power supply (partially integrated or can be ordered as option)
- 3 or 8 m long preassembled cables for connecting MTA terminal module and ET 200M module, in each case with:
 - 50/25-contact Sub-D socket or 25-contact Sub-D plug, for connection to MTA terminal
 - 40/20-pole Siemens front connector, female version, for connection to ET 200M module
- Screw terminals for the 1:1 connection of field devices, sensors and actuators
- Protection of channels frequently by fuse or electronic current limitation, partially with LED display
- Test and release as SIMATIC PCS 7 system component with corresponding approvals (FM, UL, CE, ATEX, TÜV)

Design (continued)

Product overview with information on combinable ET 200M modules and connection cables

MTA type	Input/output area	Order No. of MTA and accessories	Order No. of ET 200M module	Order No. of connecting cable	I/O redundancy
8 channels, AI	1 ... 5 V; ± 5 V; ± 10 V; 0 ... 20 mA; 4 ... 20 mA; ± 20 mA	6ES7 650-1AA52-2XX0 ¹⁾	6ES7 331-7NF00-0AB0 (from product version 5)	6ES7 922-3BD00-0BA0 (3 m) 6ES7 922-3BJ00-0BA0 (8 m)	Yes
8 channels, AI	1 ... 5 V; ± 5 V; ± 10 V; 0 ... 20 mA; 4 ... 20 mA; ± 20 mA	6ES7 650-1AA52-2XX0 ¹⁾	6ES7 331-7NF10-0AB0 (from product version 8)	6ES7 922-3BD00-0BB0 (3 m) 6ES7 922-3BJ00-0BB0 (8 m)	Yes
8 channels, AO	0 ... 20 mA; 4 ... 20 mA	6ES7 650-1AB51-2XX0	6ES7 332-5HF00-0AB0 (from product version 3)	6ES7 922-3BD00-0AS0 (3 m) 6ES7 922-3BJ00-0AS0 (8 m)	Yes
8 channels, AI HART	0 ... 20 mA (without use of HART) 4 ... 20 mA (with/without use of HART)	6ES7 650-1AA61-2XX0 ¹⁾	6ES7 331-7TF01-0AB0	6ES7 922-3BD01-0AM0 (3 m) 6ES7 922-3BJ01-0AM0 (8 m)	Yes
8 channels, AO HART	0 ... 20 mA (with/without use of HART) 4 ... 20 mA (with/without use of HART)	6ES7 650-1AB61-2XX0	6ES7 332-8TF01-0AB0	6ES7 922-3BD01-0AM0 (3 m) 6ES7 922-3BJ01-0AM0 (8 m)	Yes
8 channels, AI TC	Thermocouple types B, C, N, E, R, S, J, L, T, K, U	6ES7 650-1AF51-2XX0	6ES7 331-7PF10-0AB0 (from product version 4) or 6ES7 331-7PF11-0AB0	6ES7 922-3BD00-0AS0 (3 m) 6ES7 922-3BJ00-0AS0 (8 m)	No
8 channels, AI RTD	Resistance thermometers Pt100, Pt200, Pt500, Pt1000, Ni100, Ni120, Ni200, Ni500, Ni1000, Cu10	6ES7 650-1AG51-2XX0	6ES7 331-7PF00-0AB0 (from product version 8) or 6ES7 331-7PF01-0AB0	6ES7 922-3BD00-0AS0 (3 m) 6ES7 922-3BJ00-0AS0 (8 m)	No
16 channels, DO	24 V DC, 0.5 A	6ES7 650-1AD11-2XX0	6ES7 322-8BH10-0AB0	6ES7 922-3BD00-0AT0 (3 m) 6ES7 922-3BJ00-0AT0 (8 m)	Yes
6 channels F-AI HART (safety-related)	0 ... 20 mA (without use of HART); 4 ... 20 mA (with/without use of HART)	6ES7 650-1AH62-5XX0 ¹⁾	6ES7 336-4GE00-0AB0	6ES7 922-3BD00-0AU0 (3 m) 6ES7 922-3BJ00-0AU0 (8 m)	Yes
16 channels, DI	24 V DC	6ES7 650-1AC11-3XX0	6ES7 321-7BH01-0AB0 (from product version 2)	6ES7 922-3BD01-0AM0 (3 m) 6ES7 922-3BJ01-0AM0 (8 m)	Yes
24 channels F-DI (safety-related)	24 V DC	6ES7 650-1AK11-7XX0	6ES7 326-1BK00-0AB0, 6ES7 326-1BK01-0AB0 or 6ES7 326-1BK02-0AB0	6ES7 922-3BD00-0AS0 (3 m) 6ES7 922-3BJ00-0AS0 (8 m)	Yes
10 channels F-DO (safety-related)	24 V DC, 2 A	6ES7 650-1AL11-6XX0	6ES7 326-2BF01-0AB0 (from product version 2) or 6ES7 326-2BF10-0AB0	6ES7 922-3BD00-0AN0 (3 m) 6ES7 922-3BJ00-0AN0 (8 m)	Yes
16 channels DO relay	120 ... 230 V AC, 5 A; 24 V DC, 5 A	6ES7 650-1AM30-3XX0	6ES7 322-8BH01-0AB0 or 6ES7 322-8BH10-0AB0	6ES7 922-3BD00-0AS0 (3 m) 6ES7 922-3BJ00-0AS0 (8 m)	Yes
10 channels F DO relays (safety-related)	120 ... 230 V AC, 5 A; 24 V DC, 5 A	6ES7 650-1AM31-6XX0	6ES7 326-2BF01-0AB0 (from product version 2) or 6ES7 326-2BF10-0AB0	6ES7 922-3BD00-0AS0 (3 m) 6ES7 922-3BJ00-0AS0 (8 m)	Yes

¹⁾ These new terminal modules can no longer deliver a 24 V DC current for feeding 4-wire transmitters. You require an additive terminal module MTA power supply 24 V DC (Order No. 6ES7 650-1BE10-3XX0) if you wish to continue supplying 4-wire transmitters centrally per MTA and redundant with 24 V DC.

SIMATIC PCS 7 system hardware

Process I/O

SIMATIC ET 200M for SIMATIC PCS 7

MTA terminal modules

Ordering data	Article No.	Article No.	
MTA terminal modules for SIMATIC PCS 7			
MTA AI terminal module, 8-channel Terminal module for connection of field devices/sensors to a single or two redundant ET 200M analog input modules 6ES7331-7NF00-0AB0 or 6ES7331-7NF10-0AB0 Input range: 1 to 5 V; ± 5 V; ± 10 V und 0/4 ... 20 mA; ± 20 mA Note: 4-wire devices must be supplied separately with current.	6ES7650-1AA52-2XX0	MTA F-AI HART terminal module, 6-channel Terminal module for connection of field devices/sensors to a single or two redundant safety-related ET 200M analog input modules 6ES7336-4GE00-0AB0 Input range: 0 ... 20 mA (without use of HART), 4 ... 20 mA (with/without use of HART) Note: 4-wire devices must be supplied separately with current.	6ES7650-1AH62-5XX0
MTA AO terminal module, 8-channel Terminal module for connection of field devices/actuators to a single or two redundant ET 200M analog output modules 6ES7332-5HF00-0AB0 Output range: 0/4 ... 20 mA	6ES7650-1AB51-2XX0	MTA DI terminal module, 16-channel Terminal module for connection of field devices/sensors to a single or two redundant ET 200M digital input modules 6ES7321-7BH01-0AB0 Input range: 24 V DC	6ES7650-1AC11-3XX0
MTA AI HART terminal module, 8-channel Terminal module for connection of field devices/sensors to a single or two redundant ET 200M analog input modules 6ES7331-7TF01-0AB0 Input range: 0 ... 20 mA (without use of HART), 4 ... 20 mA (with/without use of HART) Note: 4-wire devices must be supplied separately with current.	6ES7650-1AA61-2XX0	MTA F-DI terminal module, 24-channel Terminal module for connection of field devices/sensors to a single or two redundant safety-related ET 200M digital input modules 6ES7326-1BK00-0AB0, 6ES7326-1BK01-0AB0 or 6ES7326-1BK02-0AB0 Input range: 24 V DC	6ES7650-1AK11-7XX0
MTA AO HART terminal module, 8-channel Terminal module for connection of field devices/actuators to a single or two redundant ET 200M analog output modules 6ES7332-8TF01-0AB0 Output range: 0 to 20 mA (with/without use of HART), 4 ... 20 mA (with/without use of HART)	6ES7650-1AB61-2XX0	MTA F-DO terminal module, 10-channel Terminal module for connection of field devices/actuators to a single or two redundant safety-related ET 200M digital output modules 6ES7326-2BF01-0AB0 or 6ES7326-2BF10-0AB0 Output range: 24 V DC, 2A	6ES7650-1AL11-6XX0
MTA AI TC terminal module, 8-channel Terminal module for connection of field devices/sensors to a single ET 200M analog input module 6ES7331-7PF10-0AB0 or 6ES7331-7PF11-0AB0 Input range: Thermocouple types B, C, N, E, R, S, J, L, T, K, U	6ES7650-1AF51-2XX0	MTA DO Relay terminal module, 16-channel Terminal module for connection of field devices/actuators to a single or two redundant ET 200M digital output modules 6ES7322-8BH01-0AB0 or 6ES7322-8BH10-0AB0 Output range: 120 to 230 V AC, 5 A; 24 V DC, 5 A	6ES7650-1AM30-3XX0
MTA AI RTD terminal module, 8-channel Terminal module for connection of field devices/sensors to a single ET 200M analog input module 6ES7331-7PF00-0AB0 or 6ES7331-7PF01-0AB0 Measuring range: Resistance thermometers Pt100, Pt200, Pt500, Pt1000, Ni100, Ni120, Ni200, Ni500, Ni1000, Cu10	6ES7650-1AG51-2XX0	MTA F-DO Relay terminal module, 10-channel Terminal module for connection of field devices/actuators to a single or two redundant safety-related ET 200M digital output modules 6ES7326-2BF01-0AB0 or 6ES7326-2BF10-0AB0 Output range: 120 to 230 V AC, 5 A; 24 V DC, 5 A	6ES7650-1AM31-6XX0
MTA DO terminal module, 16-channel Terminal module for connection of field devices/actuators to a single or two redundant ET 200M digital output modules 6ES7322-8BH10-0AB0 Output range: 24 V DC, 0.5 A	6ES7650-1AD11-2XX0		

Ordering data	Article No.	Ordering data	Article No.
Separate power supply for field devices, for example 4-wire transmitter		Connecting cable with 40-pin front connector for ET 200M and 25-pin Sub-D plug for MTA Lengths: • 3 m • 8 m	6ES7922-3BD00-0AT0 6ES7922-3BJ00-0AT0
MTA terminal module 24 V DC power supply, 16-channel Terminal module for the redundant power supply of field devices separated from the signal transmission Output range: 24 V DC, 0.5 A	6ES7650-1BE10-3XX0	Connecting cable with 40-pin front connector for ET 200M and 25-pin Sub-D socket for MTA Lengths: • 3 m • 8 m	6ES7922-3BD00-0AN0 6ES7922-3BJ00-0AN0
Pre-assembled cable for connection of ET 200 module and MTA terminal module		Connecting cable with 20-pin front connector for ET 200M and 25-pin Sub-D socket for MTA Lengths: • 3 m • 8 m	6ES7922-3BD01-0AM0 6ES7922-3BJ01-0AM0
Connecting cable with 40-pin front connector for ET 200M and 50-pin Sub-D socket for MTA Lengths: • 3 m • 8 m	6ES7922-3BD00-0AS0 6ES7922-3BJ00-0AS0	Connecting cable with 20-pin front connector for ET 200M and 50-pin Sub-D socket for MTA Lengths: • 3 m • 8 m	6ES7922-3BD00-0AU0 6ES7922-3BJ00-0AU0
Connecting cable with 40-pin front connector for ET 200M and 25-pin Sub-D socket for MTA Lengths: • 3 m • 8 m	6ES7922-3BD00-0BA0 6ES7922-3BJ00-0BA0	Accessories	
Connecting cable with 40-pin front connector for ET 200M and 25-pin Sub-D socket for MTA Lengths: • 3 m • 8 m	6ES7922-3BD00-0BB0 6ES7922-3BJ00-0BB0	Power monitor board (PMB) for display of status of redundant MTA power supply	6ES7650-1BA02-0XX0

More information

Detailed information on the MTA terminal modules can be found in the manual "ET 200M Marshallled Termination Assemblies Remote I/O Modules".

SIMATIC PCS 7 system hardware

Process I/O

SIMATIC ET 200SP for SIMATIC PCS 7

Overview



SIMATIC ET 200SP is a highly flexible and scalable I/O system with IP20 protection which can communicate with SIMATIC PCS 7 automation systems (controllers) via PROFINET IO or PROFIBUS DP. Designed for installation in enclosures or control cabinets, it convinces with a particularly compact design, exceptional usability, and impressive performance.

The comprehensive, channel-specific and easy-to-program diagnostics with plain text messages means that faults can be located and eliminated in an extremely short time.

Summary of main features

- Remote I/O stations with IP20 protection, can be networked via PROFINET IO and PROFIBUS DP
- Free selection of PROFINET connection system and hardware using BusAdapter (BA 2xRJ45, BA 2xFC, BA 2xSCRJ, BA 2xLC, BA LC/FC, BA LC/RJ45, BA SCRJ/RJ45 or BA SCRJ/FC)
- System redundancy S2: ET 200SP station can establish communication to each of the two CPUs of an AS redundancy station via an interface module
- >Up to 64 I/O modules (digital/analog); full data volume up to 1 440 bytes (with S2 system redundancy to 1 000 bytes)
- Compact, rugged, and easy-to-service design with permanent wiring:
 - Shielded backplane bus, designed as module rack using BaseUnits
 - Push-in terminals for quick, one-handed wiring without the use of tools
 - Excellent accessibility of terminals arranged in rows
 - I/O module and terminal box can be replaced during operation (hot swapping)
 - Automatic coding of the I/O modules prevents destruction of the electronics due to faulty equipping
 - Simple retrofitting of modules at the station end without reconfiguration
 - Unambiguous inscription and color concept helps avoid faults
 - Consistent shielding of conductor via terminal box and backplane bus to the PROFINET cable
 - Low space requirement allows high packing density in the control cabinet
- Significant system functions
 - Self-assembling potential groups without external wiring or jumpers
 - Individual load groups can be formed without extra power modules
 - Partial commissioning: Tolerating of gaps in the design through reservation of slots for further configuration
 - Electronic rating plate (I&M data 0...3)
 - Extensive diagnostics, channel-specific

Design

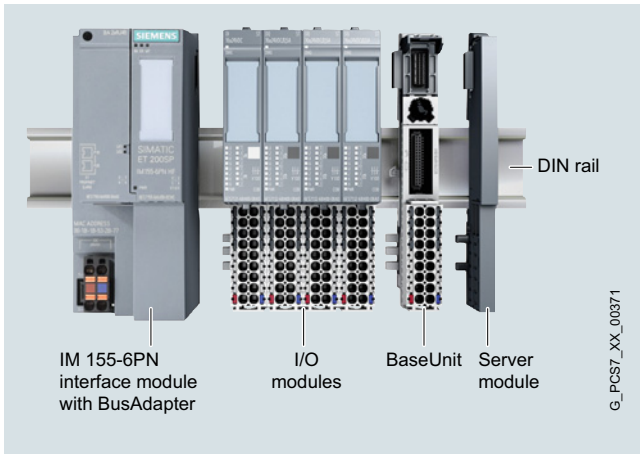

ET 200SP for SIMATIC PCS 7, design

Main components of the SIMATIC ET 200SP distributed I/O system

- PROFINET IM 155-6PN/2 High Feature interface module with BusAdapter (separate component for establishing the connection system) for communication with the SIMATIC PCS 7 automation system (controller) via PROFINET IO
- PROFIBUS IM 155-6DP High Feature interface module is used as DP slave on PROFIBUS DP and connects the ET 200SP with the DP master
- I/O modules
4, 8 or 16 digital channels (DI, DQ, RQ) and 2, 4 or 8 analog channels (AI, AQ); up to 64 I/O modules can be plugged into passive BaseUnits in any combination
- BaseUnits
Supports for the plug-in I/O modules and the terminal box; for construction of the backplane bus and for the mechanical/electrical connections
- Server module
for connection of ET 200SP station
- DIN rail
for latching-in of interface module, BaseUnits and server module; for installation of ET 200SP station in control cabinet

The extremely compact design allows a high packing density. With a depth of approx. 75 mm, the overall height is e.g.:

- 117 mm with 16 channels and 1-wire connection (without AUX terminals)
- 141 mm with 8 channels and 3-wire connection and AUX terminals

Replaceable BusAdapters enable free selection of the PROFINET connection system.

The BaseUnits mounted on a DIN rail can already be wired and tested prior to connection of the I/O modules (permanent wiring).

Hot swapping of the I/O modules and terminal boxes plugged onto the BaseUnits is possible. Mechanical coding prevents the use of an incorrect slot and the resulting destruction of the module electronics.

A BU cover is available for reserved, unequipped slots (BaseUnit without I/O module) as protection for the BaseUnit connectors. It can be provided with a reference ID label.

For connection of cable shields that is both space-saving and optimized in terms of EMC, a shield connection is available that is quick and easy to mount. This consists of a shield connection element that can be plugged onto the BaseUnit and a shield terminal.

An inscription and color identification system with the following components facilitates orientation:

- Labeling strips for insertion in interface and I/O modules (foil on rolls for thermal transfer printers or pre-perforated A4 size paper for laser printers)
- Color-coded labels for cable assignment and identification of I/O module potentials
- Equipment labeling plates for interface module, BusAdapter, BaseUnits and I/O modules for identifying system components

Installation

Installation of an ET 200SP station is quick and easy:

- Latching-in of interface module, BaseUnits and server module on a DIN rail (35 x 15 x 7.5 mm or 35 x 15 x 15 mm)
- Connection of the cables for the 24 V DC power supply on the interface module
- Plugging on and screwing tight the BusAdapter
- Prewiring of the 24 V DC power supply and process signal cables on the BaseUnits
- Plugging on the I/O modules

The ET 200SP station can be installed in any orientation in an enclosure or control cabinet. The preferred position is horizontal.

Configuration limits and guidelines

- PROFINET IO: up to 64 I/O modules (digital/analog); full data volume up to 1 440 bytes (with S2 system redundancy up to 1 000 bytes)
- PROFIBUS DP: up to 32 I/O modules; up to 244 bytes of user data
- The thermal continuous current for the load or encoder supply can be a maximum of 10 A per potential group.

SIMATIC PCS 7 system hardware

Process I/O

SIMATIC ET 200SP for SIMATIC PCS 7

Technical specifications

Selected technical specifications of the ET 200SP in the context of SIMATIC PCS 7:

Design	
Degree of protection	IP20
Design	Discretely scalable
Installation	DIN rail (standard mounting rail)
Connection system for sensors/actuators	Single-conductor or multi-conductor connection; push-in terminals
Power supply	
Rated voltage	24 V DC; tolerance range: 19.2 ... 28.8 V DC (static); 18.5 ... 30.2 V DC (dynamic)
Relevant properties	
Safety engineering	No
For use in hazardous areas	Zones 2, 22
Increased availability	No (can be operated on the redundant automation system using system redundancy S2)
Temperature range	
• Horizontal installation	0 ... +60 °C ¹⁾
• Vertical installation	0 ... +50 °C ¹⁾
Resistance to vibration	Up to 1 g with BA 2xRJ45; up to 5 g with BA 2xFC
System functions	
Permanent wiring	Yes
Hot swapping	Yes
Expansion/configuration during ongoing operation	No
Diagnostics (module-dependent)	Channel-discrete
Functions	
Digital channels	Yes
Analog channels	Yes
HART	Yes
Motor starters	No
Pneumatic connection	No
Technological functions	No

Approvals, standards

- CE for industrial applications
 - Interference emission
 - Noise immunity
 - ATEX in accordance with EN 60079-15 and EN 60079-0
 - IECEx in accordance with EN 60079-15 and EN 60079-0
 - AS/NZS for Australia and New Zealand
 - cULus in accordance with UL 508, CSA C22.2 No. 142 and No. 213, ANSI/ISA 12.12.01
 - PROFIBUS
 - IEC
 - CE
 - CCC
 - KCC
 - Shipbuilding approval
- According to 94/9/EC, 2004/108/EC and 2006/95/EC
EN 61000-6-4:2007
EN 61000-6-2:2005
II 3 G Ex nA IIC Tx Gc DEKRA 12ATEX0038X
Ex nA IIC Tx Gc IECEx DEK 13.0011X
AS/NZS CISPR 16
Class I, Division 2, Groups A, B, C, D, Tx
Class I, Zone 2, Group IIC Tx
IEC 61784-1:2010 Ed3 CP 3/1
IEC 61131-2
According to 94/9/EC, 2004/108/EC and 2006/95/EC
Certificate for China Compulsory Product Certification
Korean Certification
KCC-REM-S49-ET200SP
Classification companies
• ABS (American Bureau of Shipping)
• BV (Bureau Veritas)
• DNV (Det Norske Veritas)
• GL (Germanischer Lloyd)
• LRS (Lloyds Register of Shipping)
• Class NK (Nippon Kaiji Kyokai)

¹⁾ Also available in a SIPLUS version for extended temperature range (up to -40 ... +70 °C) and aggressive atmosphere/condensation (for details, see <http://www.siemens.com/siplus> and catalog ST 70).

For a large number of components of the ET 200SP distributed system, the ambient temperature range during operation is extended to -30 °C (without condensation or icing) in all mounting positions. The permissible installation elevation for some modules has also been extended to installation altitudes up to 5,000 m. For details, see <https://support.industry.siemens.com/cs/ww/en/view/109767369>

For detailed technical specifications, especially on individual components such as interface modules, BaseUnits or I/O modules, see:

- Catalog ST 70, section "IO Systems"
- Industry Mall under "Automation technology - Automation systems - SIMATIC industrial automation systems - IO systems - SIMATIC ET 200 systems for control cabinets - SIMATIC ET 200SP"
- SIMATIC ET 200SP Manual Collection:
<https://support.industry.siemens.com/cs/ww/en/view/84133942>

More information

General information

<http://www.siemens.com/et200sp>

TIA Selection Tool

Note:

When working with the TIA Selection Tool in the context of SIMATIC PCS 7, please note the specified limitations for the ET 200SP in the "SIMATIC ET 200SP for SIMATIC PCS 7" section with regard to area of application and product range.

<http://www.siemens.com/tia-selection-tool>

Overview



PROFINET IM 155-6PN High Feature interface module, with reference ID label

PROFINET Interface Module IM 155-6PN/2 High Feature

- Interface module for connecting the ET 200SP station to PROFINET IO
- 24 V DC supply for interface module and backplane bus
- Integrated 2-port switch for line configuration
- Handling of complete data transfer with the controller
- Data exchange with the I/O modules via the backplane bus
- Support of identification data I&M0 to I&M3
- Delivery including server module
- BusAdapter with integrated 2-port switch for individual selection of the PROFINET IO connection system can be ordered separately

PROFIBUS IM 155-6DP High Feature interface module

- Max. 32 I/O modules, also PROFI-safe modules with complete diagnostic support
- Max. 244 bytes in each case for input and output data per module and per station
- Data update time: Typ. 5 ms
- PROFIBUS connection via 9-pin sub-D socket
- Bundle including server module and PROFIBUS plug



BusAdapter BA 2xRJ45

BusAdapter (BA)

A BusAdapter can be used to adapt the universal PROFINET IO interface of the interface module to the specific requirements of the environment of use. If a connection socket is faulty or when changing the connection system at a later stage, it is only necessary to replace the BusAdapter.

The following BusAdapters are available:

- **BA 2xRJ45**
With two sockets for commercially available RJ45 plugs; suitable for standard applications with moderate mechanical strength and EMI resistance
- **BA 2xFC**
With two FastConnect terminals for direct connection of the bus cables; suitable for applications with higher mechanical strength and/or EMI resistance (5x higher resistance against vibrations and EMI)
- **BA 2xSCRJ**
With two optical PROFINET interfaces for connection of optical-fiber cables via SC RJ plug-in connectors (5x higher resistance against vibrations and EMI; PROFINET cable lengths between two stations up to 300 m)
- **BA 2xLC**
With two optical PROFINET interfaces for connecting fiber-optic cables LC multimode glass-fiber
- **BA LC/RJ45**
With two PROFINET interfaces:
 - 1 x optical, for connection of fiber-optic cables via LC multimode fiber-optic cable (port 1)
 - 1 x electrical, for connection of bus cable with standard RJ45 plug (port 2)
- **BA LC/FC**
With two PROFINET interfaces:
 - 1 x optical, for connection of fiber-optic cables via LC multimode fiber-optic cable (port 1)
 - 1 x electrical, for direct connection of FastConnect bus cable (port 2)
- **BA SCRJ/RJ45**
With two PROFINET interfaces:
 - 1 x optical, for connection of fiber-optic cables via SC RJ connectors (port 1)
 - 1 x electrical, for connection of bus cable with standard RJ45 plug (port 2)
- **BA SCRJ/FC**
With two PROFINET interfaces (5x higher resistance against vibrations and EMI):
 - 1 x optical, for connection of fiber-optic cables via SC RJ connectors (port 1)
 - 1 x electrical, for direct connection of FastConnect bus cable (port 2)

SIMATIC PCS 7 system hardware

Process I/O

SIMATIC ET 200SP for SIMATIC PCS 7

Interface modules and BusAdapter**Design**

The IM 155-6PN/2 High Feature interface module is snapped directly onto the DIN rail.

Device features:

- Diagnostics displays for errors (ERROR), Maintenance (MAINT), operation (RUN) and power supply (PWR) as well as one link LED per port
- Optional inscription with labeling strips (light gray), available as:
 - Roll for thermal transfer continuous feed printer with 500 strips each
 - Paper sheets for laser printer, A4 format, with 100 strips each
- Optional equipping with a reference ID label

The selected BusAdapter is simply plugged onto the interface module and secured with a screw. It can be equipped with a reference ID label.

Ordering data**Article No.**

PROFINET IM 155-6PN/2 High Feature interface module Including server module, without BusAdapter	6ES7155-6AU01-0CN0
PROFIBUS IM 155-6DP High Feature interface module Bundle comprising interface module, server module and PROFIBUS plug	6ES7155-6BA01-0CN0
Accessories	
BusAdapter BA 2xRJ45 2 x RJ45 connection for PROFINET	6ES7193-6AR00-0AA0
BusAdapter BA 2xFC 2 x FastConnect (FC) connection for PROFINET	6ES7193-6AF00-0AA0
BusAdapter BA 2xSCRJ 2 x SCRJ FO connection for PROFINET	6ES7193-6AP00-0AA0
BusAdapter BA 2XLC 2 x glass fiber-optic cable connection for PROFINET	6ES7193-6AG00-0AA0
BusAdapter BA LC/RJ45 With media converter glass FOC - Cu; 1 x LC connection and 1 x RJ45 connection for PROFINET	6ES7193-6AG20-0AA0
BusAdapter BA LC/FC With media converter glass FOC - Cu; 1 x LC connection and 1 x FastConnect connection for PROFINET	6ES7193-6AG40-0AA0
BusAdapter BA SCRJ/RJ45 With media converter FOC-Cu; 1 x SCRJ FO and 1 x RJ45 connection for PROFINET	6ES7193-6AP20-0AA0
BusAdapter BA SCRJ/FC With media converter FOC-Cu; 1 x SCRJ FO and 1 x FastConnect connection for PROFINET	6ES7193-6AP40-0AA0

Article No.

Equipment labeling plates 10 sheets of 16 labels	6ES7193-6LF30-0AW0
Labeling strips • 500 labeling strips on roll, light gray • 1 000 labeling strips, A4 format, light gray	6ES7193-6LR10-0AA0 6ES7193-6LA10-0AA0
DIN rail 35 mm • Length: 483 mm for 19" cabinets • Length: 530 mm for 600 mm cabinets • Length: 830 mm for 900 mm cabinets • Length 2 m	6ES5710-8MA11 6ES5710-8MA21 6ES5710-8MA31 6ES5710-8MA41
Spare parts	
Server module (spare part)	6ES7193-6PA00-0AA0
Power supply connector interface module (spare part) For 24 V DC supply • With push-in terminals (10 units) • With screw-type terminals (10 units)	6ES7193-4JB00-0AA0 6ES7193-4JB50-0AA0

Overview**BaseUnits**

- Type A0 BaseUnits with 16 process terminals
 - Terminal box light
 - Terminal box light, with 10 additional AUX terminals (internally jumpered)
 - Terminal box dark
 - Terminal box dark, with 10 additional AUX terminals (internally jumpered)
- Type A1 BaseUnits for analog modules for temperature detection with 16 process terminals
 - Terminal box light
 - Terminal box light, with 2 × 5 internally jumpered add-on terminals
 - Terminal box dark
 - Terminal box dark, with 2 × 5 internally jumpered add-on terminals
- BaseUnit type B1 for digital input module, terminal box dark; 12 process terminals
- Type B0 BaseUnit for digital output module with relays, terminal box dark; 12 process terminals and 4 internally jumpered AUX terminals

I/O modules

- Digital I/O modules
 - Digital input modules, 4, 8 or 16 channels
 - Digital output modules, 4, 8 or 16 channels, including relay module
- Analog I/O modules
 - Analog input modules, 2, 4 or 8 channels
 - Analog output modules, 2 or 4-channel

Supplementary material

- BU cover
- Labeling strips
- Equipment labeling plates
- Color-coded labels
- Shield connection

SIMATIC PCS 7 system hardware

Process I/O

SIMATIC ET 200SP for SIMATIC PCS 7

BaseUnits and I/O modules

Design



ET 200SP BaseUnit

BaseUnits

The I/O modules are plugged into BaseUnits (BU). Suitable BaseUnit versions include all those which correspond to the BU type (A0/A1/B0/B1/D0) of the selected I/O module.

The BaseUnits provide electrical and mechanical connections between the I/O modules. To this end, the BaseUnits are mounted on a standard rail and latched into each other from the side.

The module slot also has a position for a coding element. This automatically codes the I/O module type when it is inserted for the first time, and prevents any different type of module from being inserted.

Each BaseUnit has a replaceable terminal box. In addition to the process terminals, this has two terminals (L+ and M) for the 24 V DC supply for the I/O modules and sensors. The plug-in terminals are designed to be space-saving and easy to fit.

BaseUnits are available with light or dark terminal boxes. BaseUnits with a light terminal block (light BUs) separate the self-assembling voltage buses (P1, P2, and AUX) from the adjacent module on the left and thus open up a new load group. The 24 V DC supply for the I/O modules and sensors of this load group (max. thermal continuous load 10 A) is connected to P1 (+) and P2 (-) via the terminals at the bottom with red and blue spring NC contacts.

BaseUnits with dark terminal box (dark BUs) are connected onto the right of a light BU. Contrary to the light BUs, they link the voltage buses P1, P2 and AUX to the adjacent module on the left and thus extend the voltage group. A new power supply is therefore only necessary at the next light BU.

Certain BaseUnits additionally have internally jumpered AUX terminals. Potentials of up to 24 V DC or protective earth (PE) conductors can be connected to the AUX rails.

The BaseUnits of type A1 which can be connected to analog modules for temperature detection enable recording of the terminal temperature using an integrated sensor for automatic temperature compensation for thermocouples. These BaseUnits are also available with 2 × 5 add-on terminals (internally jumpered).

Supplementary material for I/O modules and BaseUnits

BU cover

Unequipped BaseUnit slots reserved for later use can be protected by a BU cover. A 15 or 20 mm wide BU cover must be selected depending on the type of BaseUnit. It can be provided with a reference ID label.

Labeling strips

Appropriate light gray labeling strips for insertion in I/O modules are available in two different materials:

- Roll for thermal transfer roll printer with 500 labeling strips each
- Paper sheets for laser printer, A4 format, with 100 labeling strips each

Equipment labeling plates

The reference ID labels delivered as a package comprising 10 sheets with 16 strips each are used to identify bus adapters and BaseUnits as well as interface and I/O modules. The labels suitable for printing with commercially available thermal transfer printers are easy to insert into the corresponding module.

Color-coded labels

To prevent wiring errors, the potentials at the terminals of the BaseUnits can be coded using color-coded labels. The color-coded labels are simply attached to the terminal box. The following versions are available:

- Module-specific color-coded labels for process terminals. Selection is made depending on the color code (CCxx) printed on the front of the I/O module. The color code CC00 means that a color-coded label is not available for the process terminals of this I/O module.
- Color-coded labels for the 10 AUX terminals of BaseUnit type A0 in red, blue, and yellow/green.
- Color-coded labels for the 2 × 5 add-on terminals of the BaseUnit type A1 in red/blue.
- Color-coded labels for the 4 AUX terminals of BaseUnits type B0 in red, blue, and yellow/green.

Shield connection

A shield connection that is quick and easy to mount, comprising a shield connection element (can be plugged into the BaseUnit) and a shield terminal, permit the connection of cable shields that is both space-saving as well as optimized in terms of EMC. The shielded cable is fixed to the shield connecting element by means of the shield terminal. The low-impedance connection to the functional ground (standard mounting rail) does not require any additional wiring by the user.

The shield connection is supplied as a package containing 5 shield connection elements and 5 shield terminals.

Ordering data

Refer to the I/O modules for ordering data of the BaseUnits

Overview



ET 200SP I/O module

- Can be plugged into type A0 and B1 BaseUnits (BU) with automatic coding
- LED display for error, operation, power, and status
- Clear labeling on front of module
 - Plain text identification of the module type and function class
 - 2D matrix code (article and serial number)
 - Connection diagram
 - Hardware and firmware version
 - Color code CC for module-specific color coding of the potentials at the BU terminals
 - Complete Article No.
- Optional labeling accessories
 - Labeling strips
 - Equipment labeling plate
- Optional module-specific color identification of the terminals according to the color code CC

Design

Digital input modules

- 4, 8 or 16 channels
- Color coding of the module type DI: White
- Usable types:
 - DI 8x24VDC Standard for BU type A0, color code CC01
 - DI 8x24VDC High Feature for BU type A0, color code CC01
 - DI 16x24VDC Standard for BU type A0, color code CC00
 - DI 8x24VDC NAMUR High Feature for BU type A0, color code CC01
 - DI 4x 120...230VAC Standard for BU type B1, color code CC41

Digital output modules

- 4, 8 or 16 channels
- Color coding of module types DQ and RQ: Black
- Usable types:
 - DQ 4x24VDC/2A Standard for BU type A0, color code CC02
 - DQ 8x24VDC/0.5A Standard for BU type A0, color code CC02
 - DQ 8x24VDC/0.5A High Feature for BU type A0, color code CC02
 - DQ 16x24VDC/0.5A Standard for BU type A0, color code CC00
 - DQ 4x24...230VAC/2A Standard for BU type B0, B1, color code CC41
 - RQ NO 4x120VDC-230VAC/5A Standard, BU type B0, color code CC00

Ordering data

Article No.

Digital input modules

Digital input modules

- | | |
|--|--------------------|
| • DI 8x24VDC Standard, BU type A0, color code CC01 | 6ES7131-6BF01-0BA0 |
| • DI 16x24VDC Standard, BU type A0, color code CC00 | 6ES7131-6BH01-0BA0 |
| • DI 8x24VDC High Feature, BU type A0, color code CC01 | 6ES7131-6BF00-0CA0 |
| • DI 8x24VDC High Speed, BU type A0, color code CC01 | 6ES7131-6BF00-0DA0 |
| • DI 8x24VDC NAMUR High Feature, for BU type A0, color code CC01 | 6ES7131-6TF00-0CA0 |
| • DI 4x120...230VAC Standard, for BU type B1, color code CC41 | 6ES7131-6FD01-0BB1 |

Usable BaseUnits

- | | |
|---|--------------------|
| BU15-P16+A0+2D
BU type A0; BaseUnit (light), 15 mm wide, with 16 process terminals to the module; for starting a new load group (max. 10 A) | 6ES7193-6BP00-0DA0 |
|---|--------------------|

- | | |
|--|--------------------|
| BU15-P16+A0+2B
BU type A0; BaseUnit (dark), 15 mm wide, with 16 process terminals to the module; for continuing the load group | 6ES7193-6BP00-0BA0 |
|--|--------------------|

- | | |
|---|--------------------|
| BU15-P16+A10+2D
BU type A0; BaseUnit (light), 15 mm wide, with 16 process terminals (1...16) to the module and an additional 10 internally jumpered AUX terminals (1A to 10 A); for starting a new load group (max. 10 A) | 6ES7193-6BP20-0DA0 |
|---|--------------------|

- | | |
|--|--------------------|
| BU15-P16+A10+2B
BU type A0; BaseUnit (dark), 15 mm wide, with 16 process terminals (1...16) to the module and an additional 10 internally jumpered AUX terminals (1A to 10 A); for continuing the load group | 6ES7193-6BP20-0BA0 |
|--|--------------------|

- | | |
|--|--------------------|
| BU20-P12+A0+4B
BU type B1; BaseUnit (dark), 20 mm wide, with 12 process terminals to the module; for continuing the load group | 6ES7193-6BP20-0BB1 |
|--|--------------------|

Accessories

- | | |
|---|--------------------|
| Equipment labeling plates
10 sheets with 16 labels each | 6ES7193-6LF30-0AW0 |
|---|--------------------|

- | | |
|---|--------------------|
| Labeling strips | |
| • 500 labeling strips on roll, light gray | 6ES7193-6LR10-0AA0 |
| • 1 000 labeling strips on paper sheet in A4 format, light gray | 6ES7193-6LA10-0AA0 |

- | | |
|---|--------------------|
| BU cover
For covering empty slots (gaps), 5 units | |
| • 15 mm wide | 6ES7133-6CV15-1AM0 |
| • 20 mm wide | 6ES7133-6CV20-1AM0 |

- | | |
|--|--------------------|
| Shield connection
Pack with 5 shield supports and 5 shield terminals | 6ES7193-6SC00-1AM0 |
|--|--------------------|

SIMATIC PCS 7 system hardware

Process I/O

SIMATIC ET 200SP for SIMATIC PCS 7

Digital I/O modules**Ordering data****Color-coded labels**

- 15 mm wide
 - Color code CC01, module-specific, for 16 push-in terminals; for BaseUnit type A0, A1; terminals 1 to 8 gray, terminals 9 to 16 red; 10 units
 - Color code CC71, for 10 AUX terminals 1A to 10A, yellow/green; for BU type A0 with push-in terminals; 10 units
 - Color code CC72, for 10 AUX terminals 1A to 10A, red; for BU type A0 with push-in terminals; 10 units
 - Color code CC73, for 10 AUX terminals 1A to 10A, blue; for BU type A0 with push-in terminals; 10 units
- 20 mm wide
 - Color code CC41, for 16 process terminals, BU type B1, terminals 1 to 4 gray, terminals 5 to 8 rot, terminals 9 to 12 blue; 10 units

Article No.**6ES7193-6CP01-2MA0****6ES7193-6CP71-2AA0****6ES7193-6CP72-2AA0****6ES7193-6CP73-2AA0****6ES7193-6CP41-2MB0****Digital output modules****Digital output modules**

- DQ 4x24VDC/2A Standard, BU type A0, color code CC02
- DQ 8x24VDC/0.5A Standard, BU type A0, color code CC02
- DQ 8x24VDC/0.5A High Feature, BU type A0, color code CC02
- DQ 16x24VDC/0.5A Standard, BU type A0, color code CC00
- DQ 4x24...230VAC/2A Standard, BU type B0, B1, color code CC41
- RQ NO 4x 120V DC...230VAC/5A Standard, normally open contact, for BU type B0 or B1, module diagnostics, color code CC00

6ES7132-6BD20-0BA0**6ES7132-6BF01-0BA0****6ES7132-6BF00-0CA0****6ES7132-6BH01-0BA0****6ES7132-6FD00-0BB1****6ES7132-6HD01-0BB1****Usable BaseUnits****BU15-P16+A0+2D**

BU type A0; BaseUnit (light), 15 mm wide, with 16 process terminals to the module; for starting a new load group (max. 10 A)

6ES7193-6BP00-0DA0**BU15-P16+A0+2B**

BU type A0; BaseUnit (dark), 15 mm wide, with 16 process terminals to the module; for continuing the load group

6ES7193-6BP00-0BA0**BU15-P16+A10+2D**

BU type A0; BaseUnit (light), 15 mm wide, with 16 process terminals (1...16) to the module and an additional 10 internally jumpered AUX terminals (1A to 10 A); for starting a new load group (max. 10 A)

6ES7193-6BP20-0DA0**BU15-P16+A10+2B**

BU type A0; BaseUnit (dark), 15 mm wide, with 16 process terminals (1...16) to the module and an additional 10 internally jumpered AUX terminals (1A to 10 A); for continuing the load group

6ES7193-6BP20-0BA0**Article No.****BU20-P12+A4+0B**

BU type B0; BaseUnit (dark), 20 mm wide, with 12 process terminals (1...12) to the module and an additional 4 internally jumpered AUX terminals (1A to 4A); for continuing the load group

6ES7193-6BP20-0BB0**BU20-P12+A0+4B**

BU type B1; BaseUnit (dark), 20 mm wide, with 12 process terminals to the module; for continuing the load group

6ES7193-6BP20-0BB1**Accessories**

Equipment labeling plates
10 sheets with 16 labels each

6ES7193-6LF30-0AW0**Labeling strips**

- 500 labeling strips on roll, light gray
- 1 000 labeling strips on paper sheet in A4 format, light gray

6ES7193-6LR10-0AA0**6ES7193-6LA10-0AA0****BU cover**

For covering empty slots (gaps); 5 units

- 15 mm wide
- 20 mm wide

6ES7133-6CV15-1AM0**6ES7133-6CV20-1AM0****Shield connection**

Pack with 5 shield supports and 5 shield terminals

6ES7193-6SC00-1AM0**Color-coded labels**

- 15 mm wide
 - Color code CC02, for 16 push-in terminals; for BU type A0, A1; terminals 1 to 8 gray, terminals 9 to 16 blue, 10 units
 - Color code CC71, for 10 AUX terminals 1A to 10A, yellow/green; for BU type A0 with push-in terminals; 10 units
 - Color code CC72, for 10 AUX terminals 1A to 10A, red; for BU type A0 with push-in terminals; 10 units
 - Color code CC73, for 10 AUX terminals 1A to 10A, blue; for BU type A0 with push-in terminals; 10 units
- 20 mm wide
 - Color code CC41, for 16 process terminals, BU type B1, gray (terminals 1 to 4), red (terminals 5 to 8), blue (terminals 9 to 12); 10 units
 - Color code CC81, for 4 AUX terminals 1A to 4A, yellow/green, for BU type B0; 10 units
 - Color code CC82, for 4 AUX terminals 1A to 4A, red, for BU type B0; 10 units
 - Color code CC83, for 4 AUX terminals 1A to 4A, blue, for BU type B0; 10 units

6ES7193-6CP02-2MA0**6ES7193-6CP71-2AA0****6ES7193-6CP72-2AA0****6ES7193-6CP73-2AA0****6ES7193-6CP41-2MB0****6ES7193-6CP81-2AB0****6ES7193-6CP82-2AB0****6ES7193-6CP83-2AB0**

Overview



ET 200SP I/O module

- Can be plugged into type A0, D0 or A1 BaseUnits (BU) with automatic coding
- LED display for error, operation, power, and status
- Clear labeling on front of module
 - Plain text identification of the module type and function class
 - 2D matrix code (article and serial number)
 - Connection diagram
 - Hardware and firmware version
 - Color code CC for module-specific color coding of the potentials at the terminals of the BU
 - Complete Article No.
- Optional labeling accessories
 - Labeling strips
 - Equipment labeling plate
- Optional module-specific color identification of the terminals according to the color code CC

Design

Analog input modules

- 2, 4 or 8-channels
- Color coding of the module type AI: Light blue
- Usable types:
 - AI 4xU/I 2-wire Standard for BU type A0 or A1, color code CC03
 - AI 4xI 2/4-wire Standard for BU type A0 or A1, color code CC03
 - AI 2xU/I 2/4-wire High Feature for BU type A0 or A1, color code CC05
 - AI 4xI 2-wire HART High Feature for BU type A0 or A1, color code CC03
 - AI 4xRTD/TC 2-, 3-, 4-wire High Feature for BU type A0 or A1, color code CC00
 - AI 8xRTD/TC 2-wire High Feature for BU type A0 or A1, color code CC00
 - AI Energy Meter Standard for BU type D0

Analog output modules

- 2 or 4 channels
- Color coding of the module type AQ: Dark blue
- Usable types:
 - AQ 4xU/I Standard for BU type A0 or A1, color code CC00
 - AQ 2xU/I High Feature for BU type A0 or A1, color code CC00
 - AQ 4xI HART High Feature for BU type A0 or A1, color code CC00

SIMATIC PCS 7 system hardware

Process I/O

SIMATIC ET 200SP for SIMATIC PCS 7

Analog I/O modules**Ordering data****Article No.****Article No.****Analog input modules****Analog input modules**

- AI 2xU/I 2/4-wire High Feature, BU type A0 or A1, color code CC05, 16-bit, ± 0.1 %
- AI 4xI 2-wire HART High Feature, BU type A0 or A1, color code CC03, 16-bit, ± 0.3 %
- AI 4xRTD/TC 2-, 3-, 4-wire High Feature BU type A0 or A1, color code CC00, 16-bit, ± 0.1 %
- AI 8xRTD/TC 2-wire High Feature BU type A0 or A1, color code CC00, 16-bit, ± 0.1 %
- AI 4 × I 2-/4-wire Standard, BU type A0 or A1, color code CC03, 16-bit, ± 0.3%
- AI 4XU/I 2-wire Standard, BU type A0 or A1, color code CC03, 16-bit, ± 0.3%
- AI Energy Meter Standard 480 V AC, BU type D0

Usable type A0 BaseUnits

BU15-P16+A0+2D
BU type A0; BaseUnit (light), 15 mm wide, with 16 process terminals to the module; for starting a new load group (max. 10 A)

BU15-P16+A0+2B
BU type A0; BaseUnit (dark), 15 mm wide, with 16 process terminals to the module; for continuing the load group

BU15-P16+A10+2D
BU type A0; BaseUnit (light), 15 mm wide, with 16 process terminals (1...16) to the module and an additional 10 internally jumpered AUX terminals (1A to 10 A); for starting a new load group (max. 10 A)

BU15-P16+A10+2B
BU type A0; BaseUnit (dark), 15 mm wide, with 16 process terminals (1...16) to the module and an additional 10 internally jumpered AUX terminals (1A to 10 A); for continuing the load group

Usable type A1 BaseUnits (temperature detection)

BU15-P16+A0+2D/T
BU type A1; BaseUnit (light), 15 mm wide, with 16 process terminals to the module; for starting a new load group (max. 10 A)

BU15-P16+A0+2B/T
BU type A1; BaseUnit (dark), 15 mm wide, with 16 process terminals to the module; for continuing the load group

BU15-P16+A0+12D/T
BU type A1; BaseUnit (light), 15 mm wide, with 16 process terminals (1...16) to the module and an additional 2 × 5 internally jumpered add-on terminals (1B to 5B and 1C to 5C); for starting a new load group (max. 10 A)

6ES7134-6HB00-0CA1**6ES7134-6TD00-0CA1****6ES7134-6JD00-0CA1****6ES7134-6JF00-0CA1****6ES7134-6GD01-0BA1****6ES7134-6HD01-0BA1****6ES7134-6PA20-0BD0****6ES7193-6BP00-0DA0****6ES7193-6BP00-0BA0****6ES7193-6BP20-0DA0****6ES7193-6BP20-0BA0****6ES7193-6BP00-0DA1****6ES7193-6BP00-0BA1****6ES7193-6BP40-0DA1****BU15-P16+A0+12B/T**

BU type A1; BaseUnit (dark), 15 mm wide, with 16 process terminals (1...16) to the module and an additional 2 × 5 internally jumpered add-on terminals (1B to 5B and 1C to 5C); for continuing the load group

Usable type D0 BaseUnits

BU20-P12+A0+0B
BU type D0; BaseUnit with 12 push-in terminals, without AUX terminals, bridged to the left

Accessories

Equipment labeling plates
10 sheets with 16 labels each

Labeling strips

- 500 labeling strips on roll, light gray
- 1 000 labeling strips on paper sheet in A4 format, light gray

BU cover

For covering empty slots (gaps); 5 units

- 15 mm wide
- 20 mm wide

Shield connection
Pack with 5 shield supports and 5 shield terminals

Color-coded labels, 15 mm wide

- Color code CC00, for 16 push-in terminals; for BU type A0, A1; terminals 1 to 8 gray, terminals 9 to 16 red; 10 units
- Color code CC03, module-specific, for 16 push-in terminals; for BU type A0, A1; terminals 1 to 8 gray, terminals 9 to 12 red; terminals 13 to 16 gray; 10 units
- Color code CC05, module-specific, for 16 push-in terminals; for BU type A0, A1; terminals 1 to 12 gray, terminals 13 to 14 red, terminals 15 to 16 blue; 10 units
- Color code CC71, for 10 AUX terminals 1A to 10A, yellow/green; for BU-type A0 with push-in terminals; 10 units
- Color code CC72, for 10 AUX terminals 1A to 10A, red; for BU-type A0 with push-in terminals; 10 units
- Color code CC73, for 10 AUX terminals 1A to 10A, blue; for BU type A0 with push-in terminals; 10 units
- Color code CC74, for 2 × 5 add-on terminals, 5 × red, 5 × blue, for BU type A1, with push-in terminals; 10 units

6ES7193-6BP40-0BA1**6ES7193-6BP00-0BD0****6ES7193-6LF30-0AW0****6ES7193-6LR10-0AA0****6ES7193-6LA10-0AA0****6ES7133-6CV15-1AM0****6ES7133-6CV20-1AM0****6ES7193-6SC00-1AM0****6ES7193-6CP00-2MA0****6ES7193-6CP03-2MA0****6ES7193-6CP05-2MA0****6ES7193-6CP71-2AA0****6ES7193-6CP72-2AA0****6ES7193-6CP73-2AA0****6ES7193-6CP74-2AA0**

Ordering data	Article No.	Article No.
Analog output modules		
Analog output modules		Accessories
<ul style="list-style-type: none"> AQ 4xU/I Standard, BU type A0 or A1, color code CC00, 16-bit, $\pm 0.3\%$ AQ 2xU/I High Feature, BU type A0 or A1, color code CC00, 16-bit, $\pm 0.1\%$ AQ 4xI HART High Feature, BU type A0 or A1, color code CC00, 16-bit, $\pm 0.3\%$ 	6ES7135-6HD00-0BA1 6ES7135-6HB00-0CA1 6ES7135-6TD00-0CA1	Equipment labeling plates 10 sheets with 16 labels each Labeling strips <ul style="list-style-type: none"> 500 labeling strips on roll, light gray 1 000 labeling strips on paper sheet in A4 format, light gray
Usable type A0 BaseUnits		BU cover For covering empty slots (gaps), 15 mm wide; 5 units
BU15-P16+A0+2D BU type A0; BaseUnit (light), 15 mm wide, with 16 process terminals to the module; for starting a new load group (max. 10 A)	6ES7193-6BP00-0DA0	Shield connection Pack with 5 shield supports and 5 shield terminals
BU15-P16+A0+2B BU type A0; BaseUnit (dark), 15 mm wide, with 16 process terminals to the module; for continuing the load group	6ES7193-6BP00-0BA0	Color-coded labels, 15 mm wide <ul style="list-style-type: none"> Color code CC00, for 16 push-in terminals; for BU type A0, A1; terminals 1 to 8 gray, terminals 9 to 16 red; 10 units Color code CC71, for 10 AUX terminals 1A to 10A, yellow/green; for BU-type A0 with push-in terminals; 10 units Color code CC72, for 10 AUX terminals 1A to 10A, red; for BU-type A0 with push-in terminals; 10 units Color code CC73, for 10 AUX terminals 1A to 10A, blue; for BU-type A0 with push-in terminals; 10 units Color code CC74, for 2 × 5 add-on terminals, 5 × red, 5 × blue; for BU-type A1, with push-in terminals; 10 units
BU15-P16+A10+2D BU type A0; BaseUnit (light), 15 mm wide, with 16 process terminals (1...16) to the module and an additional 10 internally jumpered AUX terminals (1A to 10 A); for starting a new load group (max. 10 A)	6ES7193-6BP20-0DA0	
BU15-P16+A10+2B BU type A0; BaseUnit (dark), 15 mm wide, with 16 process terminals (1...16) to the module and an additional 10 internally jumpered AUX terminals (1A to 10 A); for continuing the load group	6ES7193-6BP20-0BA0	
Usable type A1 BaseUnits (temperature detection)		
BU15-P16+A0+2D/T BU type A1; BaseUnit (light), 15 mm wide, with 16 process terminals to the module; for starting a new load group (max. 10 A)	6ES7193-6BP00-0DA1	
BU15-P16+A0+2B/T BU type A1; BaseUnit (dark), 15 mm wide, with 16 process terminals to the module; for continuing the load group	6ES7193-6BP00-0BA1	
BU15-P16+A0+12D/T BU type A1; BaseUnit (light), 15 mm wide, with 16 process terminals (1...16) to the module and an additional 2 × 5 internally jumpered add-on terminals (1B to 5B and 1C to 5C); for starting a new load group (max. 10 A)	6ES7193-6BP40-0DA1	
BU15-P16+A0+12B/T BU type A1; BaseUnit (dark), 15 mm wide, with 16 process terminals (1...16) to the module and an additional 2 × 5 internally jumpered add-on terminals (1B to 5B and 1C to 5C); for continuing the load group	6ES7193-6BP40-0BA1	

SIMATIC PCS 7 system hardware

Process I/O

SIMATIC ET 200pro for SIMATIC PCS 7

Overview

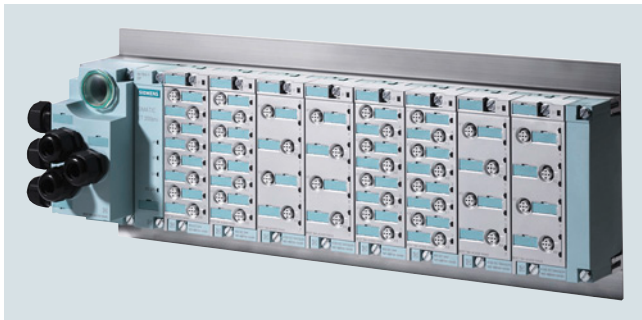

SIMATIC ET 200pro is a modular I/O system with high IP65/66/67 degree of protection suitable for use at machine level outside the control cabinet. As a result of the innovative design, the ET 200pro has a relatively small size and can be flexibly adapted to the requirements of the respective automation task with regard to the connection system and I/Os. Summary of the most important features of the SIMATIC ET 200pro:

- Distributed I/O system with IP65/67 degree of protection for cabinet-free use at machine level
- Small, multi-functional complete solution: analog and digital I/O modules as well as safety-related digital I/O modules
- Communication over PROFIBUS DP, transmission rate up to 12 Mbps
- Mixed arrangement of safety-oriented and standard modules in the same station possible
- Free selection of connection system: direct, ECOFAST or M12 7/8"
- Power module for simple implementation of load groups
- Hot swapping of modules
- Simple assembly and independent wiring
- Comprehensive diagnostics: exact to the module or channel

Design

The architecture of the ET 200pro is based on the proven separation of modules from the bus/power supply connection system. This permits the T functionality for bus and 24 V DC power supply for the interface module, and prewiring of sensor/actuator connections for the electronics modules (independent wiring). When servicing, the independent wiring permits hot swapping of an electronics module without having to switch off the remaining station. This can continue without interruption during the replacement. When replacing an electronics module, the complete I/O wiring remains on the connection module, and need be neither labeled nor removed.

Up to 16 electronics modules can be arranged in any order between the interface module (left) and the terminating module (right limit).

Modules of an ET 200pro remote I/O station

The ET 200pro modules are usually designed in two or three parts. Interface and power modules as well as digital and analog electronics modules comprise:

- Bus module as mechanical and electrical connection element of the individual ET 200pro modules (they form the backplane bus of the system)
- Electronics or interface module
- Connection module

The ET 200pro modules are fitted when delivered on the associated bus module.

A ET 200pro remote I/O station consists of:

- Module support
- Interface module for PROFIBUS DP
- Connection module for the PROFIBUS DP interface module
 - CM IM DP direct with up to 6 M20 cable glands
 - CM IM DP ECOFAST Cu
 - CM IM DP M12 7/8"
- Max. 16 electronics modules with associated connection modules which may be assembled up to a station width of 1 m
- Terminating module (included in scope of delivery of interface module)

Expansion modules

The following expansion modules are available:

- Digital electronics modules
- Analog electronic modules
- Safety-related electronic modules
- I/O connection modules
 - CM IO 4 × M12 for digital or analog electronics modules
 - CM IO 8 × M12 for digital electronics modules
 - CM IO 12 × M12 for 4/8 F-DI/4 F-DO
 - CM IO 16 × M12 for 8/16 F-DI
- Power module electronics PM-E
 - CM PM-E direct with up to 2 M20 cable glands
 - CM PM-E ECOFAST Cu
 - CM PM-E 7/8"

Design (continued)

Module support

Various module supports are available for mounting the ET 200pro:

- **Narrow module support**
With two mounting flanges, the ET 200pro remote I/O station can be completely pre-installed on this module support on the workbench.



- **Compact-narrow module support**
The compact-narrow module support permits the most space-saving design.



Expansion limits

- Number of electronics modules per station (between interface module and terminating module): up to 16
- Max. width (without module support): 1 m
- Electronics/sensor supply 1L+ max. 5 A per station
- Load voltage supply 2L+ max. 10 A per potential group
- Maximum address range of a station: 244 bytes for inputs and 244 bytes for outputs

ET 200pro configuration

The TIA Selection Tool can be used to assemble an ET 200pro remote I/O station quickly and easily. The tool is familiar with the configuration rules and supports users in the selection of all components and associated accessories in interactive mode.

<http://www.siemens.com/tia-selection-tool>

Note:

Please note when working with the TIA Selection Tool that the applications and product range of ET 200pro are limited in the context of SIMATIC PCS 7!

Integration

The distributed ET 200pro remote I/O stations are connected to SIMATIC PCS 7 automation systems (controllers) via PROFIBUS DP. Data transfer rates of up to 12 Mbit/s are possible.

The SIMATIC ET 200pro is integrated into SIMATIC PCS 7 using standard driver blocks. You can therefore configure and parameterize the ET 200pro remote I/O stations in the SIMATIC Manager of the engineering system very simply using HW Config.

Technical specifications

Technical specifications - General	
Electronics modules	<ul style="list-style-type: none"> • Digital inputs/outputs • Analog inputs/outputs • Safety-related digital inputs/outputs
Connection system for actuator/sensor	M12 round plug connection with standard assignments for actuator/sensor
Data transfer rate, max.	12 Mbit/s (PROFIBUS DP)
Supply voltage	24 V DC
Current consumption of an ET 200pro (internal and sensor supply, non-switched voltage), up to 55 °C, max.	≤ 5 A
Load current for ET 200pro per incoming supply (IM, PM, switched voltage), up to 55 °C, max.	10 A
For total configuration with looping through (several ET 200pro), up to 55 °C, max.	16 A (with direct connection module)
Degree of protection	IP65/66/IP67 for interface, digital and analog modules
Material	Thermoplast (glass-fiber reinforced)
Ambient conditions	
Temperature	0 ... 55 °C (-25 °C on request)
Relative humidity	5 ... 100 %
Atmospheric pressure	795 ... 1 080 hPa
Mechanical stress	
Vibrations	Vibration test in accordance with IEC 60068 Part 2-6 (sine) <ul style="list-style-type: none"> • Constant acceleration 5 g, occasionally 10 g, for interface, digital and analog modules • 2 g for motor starters
Shock	<ul style="list-style-type: none"> • Shock test according to IEC 680068 Part 2-27, half-sine, 30 g, 18 ms duration for interface, digital and analog modules • 15 g, 11 ms duration for motor starters
Approvals	UL, CSA and cULus

For detailed technical specifications, especially for individual components such as interface modules, power modules and electronic modules, see Catalog ST 70, Chapter "IO systems" or Industry Mall under "Automation technology - Automation systems - SIMATIC industrial automation systems - IO systems - SIMATIC ET 200 systems without control cabinets" – SIMATIC ET 200pro".

SIMATIC PCS 7 system hardware

Process I/O

SIMATIC ET 200pro for SIMATIC PCS 7

Interface modul IM 154-2 DP High Feature

Overview



The IM 154-2 DP High Feature interface module is responsible for PROFIBUS communication between the ET 200pro station and the host automation system (controller) as PROFIBUS DP master. The scope of delivery of the interface module also includes a terminating module which is plugged in following the last electronics module of the station.

Function

Features of the IM 154-2 DP High Feature interface module

- Mounted on delivery on the bus module
- Connects the ET 200pro station to the PROFIBUS DP via the connection module
- Prepares the data for the connected electronics modules
- Max. 16 electronics modules can be operated on an interface module - also safety-related
- PROFIBUS DP address of the ET 200pro station can be set on the connection module
- Terminating resistor of the PROFIBUS DP can be switched on and off on the connection module
- Maximum address range: 244 bytes for inputs and 244 bytes for outputs
- Powers the ET 200pro station via the connection module with the sensor/electronics supply 1L+ and the load power supply 2L+
- Integral power module for the load power supply 2L+
- Can be operated as DP-V1 slave on Y link

Ordering data

Article No.

IM154-2 High Feature interface module **6ES7154-2AA01-0AB0**

for ET 200pro; for communication between ET 200pro and host masters over PROFIBUS DP; supports PROFI-safe

Connection modules for IM154-2 High Feature interface module

• CM IM DP ECOFAST connection module for connection of PROFIBUS DP and 24 V DC power supply to PROFIBUS interface modules, 2 ECOFAST Cu connectors **6ES7194-4AA00-0AA0**

• CM IM DP direct connection module for direct connection of PROFIBUS DP and 24 V DC power supply to PROFIBUS interface modules, up to six M20 cable glands **6ES7194-4AC00-0AA0**

• CM IM DP M12 7/8" connection module for connection of PROFIBUS DP and 24 V DC power supply to PROFIBUS interface modules, 2 × M12 and 2 × 7/8" **6ES7194-4AD00-0AA0**

Cables and further accessories

For cables and further accessories for CM IM DP ECOFAST, CM IM DP direct and CM IM DP M12 7/8" connection modules, see Catalog ST 70, Chapter "IO systems" or Industry Mall under "Automation technology – Automation systems – SIMATIC industrial automation systems – IO systems – SIMATIC ET 200 systems without control cabinets – SIMATIC ET 200pro"

General accessories

ET 200pro module support

- Narrow, for interface, electronics and power modules
 - 500 mm **6ES7194-4GA00-0AA0**
 - 1 000 mm **6ES7194-4GA60-0AA0**
 - 2 000 mm, can be cut to length **6ES7194-4GA20-0AA0**
- Compact-narrow, for interface, electronics and power modules
 - 500 mm **6ES7194-4GC70-0AA0**
 - 1 000 mm **6ES7194-4GC60-0AA0**
 - 2 000 mm, can be cut to length **6ES7194-4GC20-0AA0**

Spare fuse **6ES7194-4HB00-0AA0**

12.5 A fast-blow, for interface and power modules, 10 units per pack

Accessories

Connection modules

The connection module for the IM 154-2 DP High Feature interface module (to be ordered separately) is available in three different connection versions:

- CM IM DP direct
- CM IM DP ECOFAST Cu
- CM IM DP M12 7/8"

The PROFIBUS address can be set on the connection module per DIL switch. The segmenting terminating resistor can be connected using a further DIL switch.

Overview



The following digital electronics modules can be used for connecting actuators/sensors in the context of SIMATIC PCS 7:

Digital input modules

- EM 8 DI DC 24 V High Feature
 - Digital electronics module with eight inputs
 - Suitable for standard switches and proximity switches (BEROs)
 - Rated input voltage 24 V DC
 - Diagnostics "Short-circuit of sensor supply to ground" per channel
 - Diagnostics "Open-circuit" per channel
 - Process alarm
 - Configurable input delay

Digital output modules

- EM 4 DO, 24 V DC; 2 A High Feature
 - Digital electronics module with four outputs
 - Suitable for solenoid valves, DC contactors and indicator lights
 - Output current 2 A per output
 - Rated load voltage 24 V DC
 - Diagnostics "Short-circuit of outputs to ground" per channel
 - Diagnostics "Short-circuit of outputs to P" per channel
 - Diagnostics "Open-circuit in outputs" per channel
 - Diagnostics "Load voltage missing" per module
 - Configurable substitute value

Ordering data

Article No.

Digital electronic modules

Digital input modules

Digital input module 8 DI High Feature 24 V DC, with channel diagnostics, including bus module. Connection module must be ordered separately	6ES7141-4BF00-0AB0
--	---------------------------

Digital output modules

Digital output module 4 DO High Feature 24 V DC, 2 A, with channel diagnostics, including bus module. Connection module must be ordered separately	6ES7142-4BD00-0AB0
--	---------------------------

Accessories

Connection module CM IO 4 x M12 4 M12 sockets for connecting digital or analog sensors/actuators to ET 200pro	6ES7194-4CA00-0AA0
---	---------------------------

Connection module CM IO 8 x M12 8 M12 sockets for connecting digital sensors/actuators to ET 200pro	6ES7194-4CB00-0AA0
---	---------------------------

Module labels for color-coded identification of the CM IOs in white, red, blue and green; pack with 100 units of each color	6ES7194-4HA00-0AA0
---	---------------------------

Further accessories

Connectors, cables and further accessories, see Catalog ST 70, section "IO systems" or Industry Mall under "Automation engineering – Automation systems – SIMATIC industrial automation systems – IO systems – SIMATIC ET 200 systems without control cabinets – SIMATIC ET 200pro"

Accessories

Connection modules

Actuators and sensors are connected using commercially-available 5-contact M12 plugs on the connection module. The connection module is plugged onto the electronics module, and screwed to the latter. The following connection modules (to be ordered separately) are available for the above-mentioned electronics modules:

- CM IO 4x M12 (for EM DI and EM DO)
- CM IO 8x M12 (for EM DI)

Depending on the selected connection module, each plug for the 8-channel digital input module has one or two channels:

- 4 x M12 round plug connections with 2 channels per plug (double assignment)
- 8 x M12 round plug connections with 1 channel per plug (single assignment)

SIMATIC PCS 7 system hardware

Process I/O

SIMATIC ET 200pro for SIMATIC PCS 7

Analog electronic modules EM 144, EM 145**Overview**

The following analog electronics modules can be used for connecting actuators/sensors in the context of SIMATIC PCS 7:

Analog input modulesEM 4 AI U High Feature

- 4 inputs for voltage measurements
- Input ranges:
 - ± 10 V, resolution 15 bits + sign
 - ± 5 V, resolution 15 bits + sign
 - 0 to 10 V, resolution 15 bit
 - 1 to 5 V, resolution 15 bit
- Electrically isolated from load voltage 2L+
- Diagnostics Short-circuit of sensor supply to ground per module
- Diagnostics Short-circuit, open-circuit per channel (depending on measuring range)
- Process interrupt with limit violation on channel 0
- Permissible common mode voltage 5 V AC pp

EM 4 AI I High Feature

- 4 inputs for current measurements
- Input ranges:
 - ± 20 mA, resolution 15 bits + sign
 - 0 to 20 mA, resolution 15 bit
 - 4 to 20 mA, resolution 15 bit
- Two-wire and four-wire transmitters can be connected
- Electrically isolated from load voltage 2L+
- Diagnostics Short-circuit of sensor supply to ground per module
- Diagnostics Short-circuit, open-circuit per channel (depending on measuring range)
- Process interrupt with limit violation on channel 0
- Permissible common mode voltage 5 V AC pp

EM 4 AI RTD High Feature

- 4 inputs for isolated (floating) resistance measurement or resistance thermometers with 2-, 3- and 4-wire connection systems
- Input ranges:
 - Resistance measurement: 150 Ω ; 300 Ω ; 600 Ω ; 3000 Ω ; resolution 15 bit
 - Resistance thermometer: Pt100; Ni100; Ni120; Pt200; Ni200; Pt500; Ni500; Pt1000; Ni1000; resolution 15 bit + sign
- Automatic compensation of line resistances with 3-wire and 4-wire connection systems
- Parameterizable temperature coefficient with resistance-type sensors
- Electrically isolated from load voltage supply 1L+ and 2L+
- Linearization of sensor characteristics
- Diagnostics Open-circuit per channel (terminals 1 and 3 are monitored for open-circuit)
- Permissible common mode voltage 10 V AC pp

EM 4 AI TC High Feature

- 4 inputs for isolated/non-isolated thermocouples or voltage measurement; resolution 15 bits + sign
- Input ranges:
 - Voltage measurement: ± 80 mV
 - Thermocouples: Type B, E, J, K, L, N, R, S, T
- Inputs are isolated from the encoder voltage supply 1L+ and load voltage supply 2L+
- Linearization of the voltage characteristic (conversion of the thermoelectric voltage to a temperature value)
- Smoothing
- Interference frequency suppression
- Various options to compensate for the reference temperature
- Overflow and underflow diagnostics

Analog output modulesEM 4 AO U High Feature

- 4 outputs for voltage output
- Output ranges:
 - ± 10 V, resolution 15 bits + sign
 - 1 to 5 V, resolution 14 bit
 - 0 to 10 V, resolution 15 bit
- Electrically isolated from sensor supply voltage 1L+
- Diagnostics Short-circuit of sensor supply to ground per module
- Diagnostics Short-circuit in outputs per channel
- Substitute value output

EM 4 AO I High Feature

- 4 outputs for current output
- Output ranges:
 - ± 20 mA, resolution 15 bits + sign
 - 4 to 20 mA, resolution 14 bit
 - 0 to 20 mA, resolution 15 bit
- Electrically isolated from sensor supply voltage 1L+
- Diagnostics Short-circuit of sensor supply to ground per module
- Diagnostics Open-circuit per channel
- Substitute value output

Ordering data	Article No.	Accessories	
Analog electronic modules			
<u>Analog input modules</u>			
Analog input module 4 AI U High Feature, ± 10 V; ± 5 V; 0 ... 10 V; 1 ... 5 V, channel diagnostics, including bus module. The terminal module must be ordered separately. Note: Only in spare part-compatible operation to 6ES7144-4FF00-0AB0!	6ES7144-4FF01-0AB0	Connection modules Actuators and sensors are connected using commercially- available 5-contact M12 plugs on the connection module. The connection module is plugged onto the electronics module, and screwed to the latter. The connection module CM IO 4 x M12 (to be ordered separately) is available for the electronics modules.	
Analog input module 4 AI I High Feature, ± 20 mA; 0 ... 20 mA; 4 ... 20 mA, channel diagnostics, including bus module. The terminal module must be ordered separately. Note: Only in spare part-compatible operation to 6ES7144-4GF00-0AB0!	6ES7144-4GF01-0AB0		
Analog input module 4 AI RTD High Feature; resistances: 150, 300, 600 and 3 000 Ohm; resistance thermometers: Pt100, 200, 500, 1000, Ni100, 120, 200, 500 and 1000; channel diagnostics, including bus module. The terminal module must be ordered separately.	6ES7144-4JF00-0AB0		
Analog input module 4 AI TC High Feature; thermocouples: Type B, E, J, K, L, N, R, S, T; voltage measurement ± 80 mV; channel diagnostics, including bus module. The terminal module must be ordered separately.	6ES7144-4PF00-0AB0		
<u>Analog output modules</u>			
Analog output module 4 AO U High Feature, ± 10 V; 0 ... 10 V; 1 ... 5 V, channel diagnostics, including bus module. The terminal module must be ordered separately.	6ES7145-4FF00-0AB0		
Analog output module 4 AO I High Feature, ± 20 mA; 0 ... 20 mA; 4 ... 20 mA, channel diagnostics, including bus module. The terminal module must be ordered separately.	6ES7145-4GF00-0AB0		
Accessories			
Connection module CM IO 4 x M12 4 M12 sockets for connecting digital or analog sensors/actuators to ET 200pro	6ES7194-4CA00-0AA0		
Module labels for color-coded identification of the CM IOs (white, red, blue, green); pack with 100 units of each color	6ES7194-4HA00-0AA0		
Further accessories			
For plugs, cables and further accessories, see Catalog ST 70, section "IO systems" or Industry Mall under "Automation engineering – Automation systems – SIMATIC industrial automation systems – IO systems – SIMATIC ET 200 systems without control cabinets – SIMATIC ET 200pro"			

SIMATIC PCS 7 system hardware

Process I/O

SIMATIC ET 200pro for SIMATIC PCS 7

Safety-related electronic modules

Overview

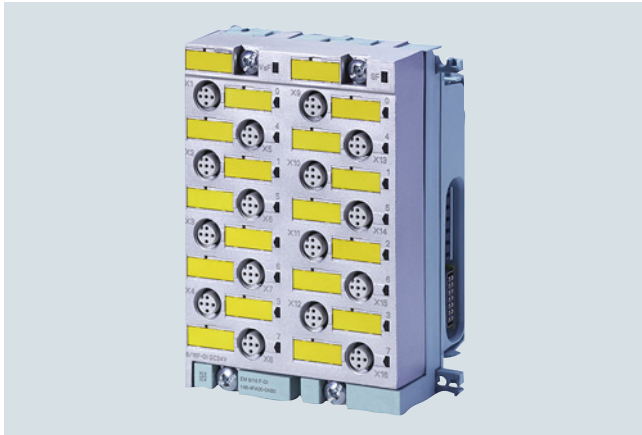

In combination with the safety-related automation systems of the SIMATIC PCS 7 process control system, the safety-related electronics modules of SIMATIC ET 200pro can be used to implement safety applications. The safety-related digital inputs record the signal statuses from safety-related sensors, and generate corresponding safety message frames for the automation system. Depending on the safety message frames of the automation system, the safety-related digital outputs trigger safe shut-down procedures. They are also responsible for monitoring short-circuits and cross-circuits up to the actuator. The safe communication with the automation systems is carried out over PROFIBUS with PROFIsafe.

All modules are certified up to SIL 3 (IEC 61508) and Cat. 4 (EN954-1).

Design

The following modules are available:

Safety-related digital input module EM 8/16 F-DI PROFIsafe

- 16 inputs (SIL2/Cat.3) or 8 inputs (SIL3/Cat.3 or Cat.4)
- Suitable for standard switches and 3/4-wire proximity switches (BEROs)
- Rated input voltage 24 V DC
- 4 short-circuit-proof sensor supplies for 4 inputs each
- External sensor power supply possible
- Group fault display (SF; red LED)
- Fault display for each sensor power supply (Vs1F to Vs4F) is output on the VsF LED and the associated channels
- Status and fault displays per input (dual-color green/red LED)
- Identification data
- Configurable diagnostics
- Can only be operated in safety mode

Safety-related digital input/output module EM 4/8 F-DI, 4 F-DO 2 A

- Inputs
 - 8 inputs (SIL 2/Cat. 3) or 4 inputs (SIL 3/Cat. 3 or Cat. 4)
 - Suitable for standard switches and 3/4-wire proximity switches (BEROs)
 - Rated input voltage 24 V DC
 - 2 short-circuit-proof sensor supplies for 4 inputs each
 - External sensor power supply possible

- Outputs
 - 4 outputs, current sourcing/sinking
 - Output current 2 A
 - Rated load voltage 24 V DC
 - Suitable for solenoid valves, DC contactors and indicator lights
- Group fault display (SF; red LED)
- Fault display for each sensor power supply (Vs1F to Vs2F) is output on the VsF LED and the associated channels
- Status and fault displays per input/output (dual-color green/red LED)
- Identification data
- Configurable diagnostics
- Achievable safety class SIL 3
- Can only be operated in safety mode

Ordering data

Article No.

Safety-related electronics modules

Safety-related digital input module

Safety-related digital input module 8/16 F-DI PROFIsafe
24 V DC, including bus module.
Connection module must be ordered separately

6ES7148-4FA00-0AB0

Safety-related digital input/output module

Safety-related digital input/output module 4/8 F-DI, 4 F-DO 2 A
24 V DC, including bus module.
Connection module must be ordered separately

6ES7148-4FC00-0AB0

Accessories

Connection module

- CM IO 16 x M12 for the electronics module 8/16 F-DI, 24 V DC/2 A
- CM IO 12 x M12 for the electronics module 4/8 F-DI/4 F-DO, 24 V DC/2 A

6ES7194-4DD00-0AA0

6ES7194-4DC00-0AA0

Further accessories

Connectors, cables and further accessories, see Catalog ST 70, section "IO systems" or Industry Mall under "Automation engineering – Automation systems – SIMATIC industrial automation systems – IO systems – SIMATIC ET 200 systems without control cabinets – SIMATIC ET 200pro"

Accessories

Connection modules

Actuators and sensors are connected using commercially available 5-pin M12 plugs on the connection module. The connection module is plugged onto the electronics module, and screwed to the latter. One of the following connection modules (to be ordered separately) is required for each of the above-mentioned electronics modules:

- Connection module CM IO 16 x M12 for the electronics module 8/16 F-DI, 24 V DC/2 A
- Connection module CM IO 12 x M12 for the electronics module 4/8 F-DI/4 F-DO, 24 V DC/2 A

Overview



The power module PM-E DC 24 V is used within an ET 200pro station when generating 24 V DC load voltage groups for electronics modules.

You can position power modules in an ET 200pro station anywhere to the right of the interface module. The first power module is already integrated in the interface module.

Each power module installed in the ET 200pro remote I/O station interrupts the load voltage busbar and opens a new potential group (common potential) for the 2L+ load voltage supply. All subsequent load voltages of the electronics modules are fed from this power module. Each power module has a replaceable fuse for protecting the device. Only line protection according to DIN VDE 0100 need be provided externally in addition.

The electronics/sensor supply 1L+ is not interrupted by the power module, it is looped through.

The power module is fitted on the associated bus module when delivered.

Ordering data

Article No.

Power module

Power module PM-E DC 24 V

For generating 24 V DC load voltage groups for electronic modules within an ET 200pro station

6ES7148-4CA00-0AA0

Accessories

Connection modules for power module

- Connection module CM PM-E ECOFAST for supply of 24 V DC load voltage, 1 ECOFAST Cu connector
- Connection module CM PM-E direct for supply of 24 V DC load voltage, one or two M20 cable glands
- Connection module CM PM-E 7/8" for supply of 24 V DC load voltage, 1 x 7/8"

6ES7194-4BA00-0AA0

6ES7194-4BC00-0AA0

6ES7194-4BD00-0AA0

Spare fuse

12.5 A fast-blow, for interface and power modules, 10 units per pack

6ES7194-4HB00-0AA0

Further accessories

For connectors, cables and further accessories, see Catalog ST 70 or Industry Mall under "Automation systems – SIMATIC industrial automation systems – I/O systems – SIMATIC ET 200 systems without control cabinet – SIMATIC ET 200pro".

Accessories

Connection module

The connection module for the power module PM-E is used to connect the load voltage 2L+. It is fitted on the power module.

The module must be ordered separately, and is available with the following types of connection:

- CM PM-E direct
- CM PM-E ECOFAST
- CM PM-E 7/8"

SIMATIC PCS 7 system hardware

Process I/O

SIMATIC ET 200pro for SIMATIC PCS 7

Power supply for ET 200pro**Overview**

SIMATIC ET 200pro PS, 24 V, 8 A

The SIMATIC ET 200pro PS is a power supply with IP67 degree of protection which features the same technology and design as the ET 200pro distributed I/O system.

It is suitable for single-line installation on the ET 200pro module rack, but can also be mounted directly on a mounting plate.

Locating the power supply away from the electronics cabinet/enclosure reduces the thermal load and the required size for the cabinet/enclosure.

The power is supplied at connector X1. The X2 connector allows the mains voltage to be looped to other modules.

The cable for the 24 V DC supply of the ET 200pro is connected via ECOFAST standard connectors to the SIMATIC ET 200pro PS. The other cable end is left open, enabling it to be fitted with an ECOFAST connector, 7/8" round connector or a programming device screw connector and individually adapted to the various connection systems of power module terminal modules of the ET 200pro.

SIMATIC ET 200pro PS reports its status via signaling contacts for "24 V DC OK" and "Overtemperature".

Ordering data**Article No.****SIMATIC ET 200pro PS, 8 A**

Stabilized power supply in the technology and design of the ET 200pro distributed I/O system, permitting the loop-through of energy to further modules; with degree of protection IP67

Input: 3 400 ... 480 V AC

Output: 24 V DC, 8 A

6ES7148-4PC00-0HA0**Accessories****Cable connectors for power connection**

- For X1 (power input); Socket insert HAN Q4/2, angled, with screw; 5 contact sockets 6 mm², 2 auxiliary contacts 0.5 mm²
- For X2 (looping mains voltage) Pin insert HAN Q4/2, angled, with screw; 4 contact pins 4 mm²

3RK1911-2BE30**3RK1911-2BF10****Sealing cap**

For 9-pole power sockets

- X2 (1 unit)
- X2 (10 units)

3RK1902-0CJ00**3RK1902-0CK00****More information**

For more information and technical specifications of the SIMATIC ET 200pro PS power supply, see "SITOP Power Supplies in SIMATIC Design" in the Catalog KT 10.1.

Additional information is available via the Internet at:

- SITOP power supplies:
<http://www.siemens.com/sitop>
- CAx data (2D, 3D, circuit diagram macros):
<http://www.siemens.com/sitop-cax>
- Operating instructions:
<http://www.siemens.com/sitop/manuals>
- SITOP Selection Tool for selecting power supplies:
<http://www.siemens.com/tst>

Update/upgrade packages



16/2	Upgrades from SIMATIC PCS 7 V8.x/V9.0 to V9.1
16/2	Upgrades for Engineering system
16/4	Upgrades for Operator System incl. OpenPCS 7 as well as Web Option for OS
16/7	Upgrades for Maintenance Station
16/8	Upgrades for SIMATIC BATCH
16/9	Upgrades for SIMATIC Route Control
16/10	Operating System Packages for SIMATIC Process Control System IPC
16/12	Upgrades for SIMATIC PCS 7 V8.x to V9.0
16/12	Upgrades for Engineering System and Management Console
16/13	Upgrades for Operator System incl. OpenPCS 7 and Web Option for OS
16/15	Upgrades for Process Historian and Information Server
16/16	Upgrades for Maintenance Station
16/17	Upgrades for SIMATIC BATCH
16/18	Upgrades for SIMATIC Route Control
16/19	Updates/Upgrades Asynchronous to the PCS 7 Version
16/19	Upgrades for SIMATIC Logon
16/20	Upgrades for SIMATIC PDM
16/22	Upgrades for Safety Integrated for Process Automation
16/24	Upgrades for S7-PLCSIM Simulation Software
16/25	System Communication via Industrial Ethernet

Update/upgrade packages

Upgrades from SIMATIC PCS 7 V8.x/V9.0 to V9.1

Upgrades for Engineering system

Overview

Engineering Upgrade Package AS/OS V9.0 to V9.1

The SIMATIC PCS 7 Engineering System with Engineering Software V9.0 can be upgraded to Version 9.1 using the SIMATIC PCS 7 Engineering Upgrade Package AS/OS.

The licenses included in the Engineering Upgrade Package AS/OS V9.0 to V9.1 apply to the following SIMATIC PCS 7 software products:

- PCS 7 ES Single Station, PCS 7 AS Engineering Software, PCS 7 AS/OS Engineering Software
- PCS 7 Import/Export Assistant
- SIMATIC Version Cross Manager
- SIMATIC Version Trail
- PCS 7 SFC Visualization
- PCS 7 BCE
- Industrial Ethernet communication software for CP

SIMATIC PCS 7 ES Single Station SN ASIA Upgrade Package V9.0 to V9.1

The ASIA regional product variants "SIMATIC PCS 7 ES Single Station SN ASIA" that comes with communication software SOFTNET-REDCONNECT can be upgraded to V9.1 with the SIMATIC PCS 7 ES Single Station SN ASIA upgrade package specifically designed for this purpose.

SIMATIC PCS 7 Logic Matrix Upgrade

A separate upgrade is available for upgrading the SIMATIC PCS 7 Logic Matrix Viewer to V9.1.

SIMATIC Version Cross Manager Upgrade

The further developed SIMATIC Version Cross Manager V9.1 is available for use in SIMATIC PCS 7 V9.1. The upgrade to SIMATIC Version Cross Manager V9.1 is part of the Engineering Upgrade Package AS/OS V8.x to V9.1.

Advanced Engineering System Upgrade

The SIMATIC PCS 7 Advanced Engineering System V8.0 (incl. SP) can be used in SIMATIC PCS 7 V8.0, V8.1, V8.2, V9.0 and V9.1. Consequently, there is no need to offer a SIMATIC PCS 7 Advanced Engineering System upgrade package for upgrading to V9.1.

Ordering data

Article No.

Engineering software

Engineering software upgrade from V9.0 to V9.1, based on existing PO number

SIMATIC PCS 7 Engineering Upgrade Package AS/OS V9.0 to V9.1

Software class A, runs with Windows 10 Enterprise 2019 LTSC and Windows Server 2019 Standard Edition 64-bit (see SIMATIC PCS 7 V9.1 Readme for the latest information), floating license for 1 user

5 languages (English, German, French, Italian, Spanish)

With SIMATIC PCS 7 Software Media Package

- Goods delivery
License key on USB flash drive, Certificate of License, bundled with 1 x SIMATIC PCS 7 Software Media Package per order item

6ES7651-8AX68-0YE5

- Online delivery
License key download, online Certificate of License, combined with SIMATIC PCS 7 Software Media Package (software download and online Certificate of License)
Note:
Email address required!

6ES7651-8AX68-0YK5

ASIA, 2 languages (English, Chinese)

With SIMATIC PCS 7 Software Media Package ASIA

- Goods delivery
ASIA license key on USB hardlock, Certificate of License, bundled with 1 x SIMATIC PCS 7 Software Media Package ASIA per order item

6ES7651-8AX68-0CE5

SIMATIC PCS 7 ES Single Station SN ASIA Upgrade Package V9.0 to V9.1 (incl. SOFTNET REDCONNECT)

2 languages (English, Chinese), software class A, runs with Windows 10 Enterprise 2019 LTSC and Windows Server 2019 Standard Edition 64-bit (see SIMATIC PCS 7 V9.1 Readme for the latest information), single license for 1 installation

Without SIMATIC PCS 7 Software Media Package ASIA

- Goods delivery
ASIA license key on USB hardlock, Certificate of License

6ES7651-8AA68-6CE0

Update/upgrade packages

Upgrades from SIMATIC PCS 7 V8.x/V9.0 to V9.1

Upgrades for Engineering system

Ordering data	Article No.	Ordering data	Article No.
SIMATIC PCS 7 Logic Matrix Upgrade from V9.0 to V9.1		Engineering software upgrade from V8.x to V9.1, based on the existing number of POs	
SIMATIC PCS 7 Logic Matrix Viewer Upgrade from V9.0 to V9.1 Runtime software, 2 languages (English, German), software class A, runs with Windows 10 Enterprise 2019 LTSC and Windows Server 2019 Standard Edition 64-bit (see SIMATIC PCS 7 V9.1 Readme for the latest information), single license for 1 installation Without SIMATIC PCS 7 Software Media Package Goods delivery License key on USB flash drive and Certificate of License	6ES7658-1JB68-2YE0	SIMATIC PCS 7 Engineering Upgrade Package AS/OS V8.x to V9.1 Software class A, runs with Windows 10 Enterprise 2019 LTSC and Windows Server 2019 Standard Edition 64-bit (see SIMATIC PCS 7 V9.1 Readme for the latest information), floating license for 1 user <u>5 languages (English, German, French, Italian, Spanish)</u> With SIMATIC PCS 7 Software Media Package • Goods delivery License key on USB flash drive, Certificate of License, bundled with 1 × SIMATIC PCS 7 Software Media Package per order item • Online delivery License key download, online Certificate of License, combined with SIMATIC PCS 7 Software Media Package (software download and online Certificate of License) Note: Email address required! <u>ASIA, 2 languages (English, Chinese)</u> With SIMATIC PCS 7 Software Media Package ASIA • Goods delivery ASIA license key on USB hardlock, Certificate of License, bundled with 1 × SIMATIC PCS 7 Software Media Package ASIA per order item	6ES7651-5AX68-0YE5 6ES7651-5AX68-0YK5 6ES7651-5AX68-0CE5
		SIMATIC PCS 7 ES Single Station SN ASIA Upgrade Package V8.x to V9.1 (incl. SOFTNET REDCONNECT) 2 languages (English, Chinese), software class A, runs with Windows 10 Enterprise 2019 LTSC and Windows Server 2019 Standard Edition 64-bit (see SIMATIC PCS 7 V9.1 Readme for the latest information), single license for 1 installation Without SIMATIC PCS 7 Software Media Package ASIA • Goods delivery ASIA license key on USB hardlock, Certificate of License	6ES7651-5AA68-6CE0

Update/upgrade packages

Upgrades from SIMATIC PCS 7 V8.x/V9.0 to V9.1

Upgrades for Operator System incl. OpenPCS 7 as well as Web Option for OS

Overview

Upgrades combined in packages allow existing operator systems to be upgraded from V8.x/V9.0 to V9.1 in line with the number of existing process objects and archive tags.

OS Software Upgrades V8.x/V9.0 to V9.1

The following upgrade packages for upgrading to V9.1 will be offered for SIMATIC PCS 7 Operator Stations with OS software V8.x/V9.0:

- SIMATIC PCS 7 OS Single Station upgrade package
- SIMATIC PCS 7 OS Server upgrade package
- SIMATIC PCS 7 OS Client/SFC Visualization upgrade package

The ASIA product variants "SIMATIC PCS 7 OS Single Station SN ASIA" and "SIMATIC PCS 7 OS Server SN ASIA" that come with SOFTNET-REDCONNECT communication software can be upgraded to V9.1 with specific upgrade packages:

- SIMATIC PCS 7 OS Single Station SN ASIA upgrade package
- SIMATIC PCS 7 OS Server SN ASIA upgrade package

Two upgrade packages of type OS Single Station or OS Server are required in each case for redundant SIMATIC PCS 7 Operator Stations.

In addition to the licenses for the PCS 7 OS Software Single Station or Server, the upgrade packages for OS Single Station and OS Server include upgrade licenses for:

- SIMATIC PCS 7 SFC Visualization
- SIMATIC PCS 7 BCE
- Industrial Ethernet communication software for CP

The upgrade license for SIMATIC PCS 7 SFC Visualization is also part of the upgrade package SIMATIC PCS 7 OS Client/SFC Visualization.

With a SIMATIC PCS 7 OS Server upgrade package, only one SIMATIC PCS 7 OS Server can be upgraded.

Upgrade of the Web Option for OS V8.x/V9.0 to V9.1

Using the SIMATIC PCS 7 OS Web Server upgrade package, you can upgrade the SIMATIC PCS 7 Web Server, SIMATIC PCS 7 Web Diagnostics Server and SIMATIC PCS 7 Web Diagnostics Clients from V8.x/V9.0 to V9.1.

Ordering data

Article No.

OS software

OS software upgrade from V9.0 to V9.1, based on existing PO number

SIMATIC PCS 7 OS Single Station Upgrade Package V9.0 to V9.1

For OS Single Station, software class A, runs with Windows 10 Enterprise 2019 LTSC (see SIMATIC PCS 7 V9.1 Readme for the latest information), single license for 1 installation

5 languages (English, German, French, Italian, Spanish)

With SIMATIC PCS 7 Software Media Package

- Goods delivery
License key on USB flash drive, Certificate of License, bundled with 1 × SIMATIC PCS 7 Software Media Package per order item

6ES7652-8AX68-0YE0

- Online delivery
License key download, online Certificate of License, combined with SIMATIC PCS 7 Software Media Package (software download and online Certificate of License)

Note:
Email address required!

6ES7652-8AX68-0YK0

ASIA, 2 languages (English, Chinese)

With SIMATIC PCS 7 Software Media Package ASIA

- Goods delivery
ASIA license key on USB hardlock, Certificate of License, bundled with 1 × SIMATIC PCS 7 Software Media Package ASIA per order item

6ES7652-8AX68-0CE0

SIMATIC PCS 7 OS Single Station SN ASIA Upgrade Package V9.0 to V9.1 (incl. SOFTNET REDCONNECT)

For OS Single Station

2 languages (English, Chinese), software class A, runs with Windows 10 Enterprise 2019 LTSC (see SIMATIC PCS 7 V9.1 Readme for the latest information), single license for 1 installation

Without SIMATIC PCS 7 Software Media Package ASIA

- Goods delivery
ASIA license key on USB hardlock, Certificate of License

6ES7658-8AA68-6CE0

SIMATIC PCS 7 OS Server Upgrade Package V9.0 to V9.1

For OS Server

Software class A, runs with Windows Server 2019 Standard Edition 64-bit (see SIMATIC PCS 7 V9.1 Readme for the latest information), single license for 1 installation

With SIMATIC PCS 7 Software Media Package

Update/upgrade packages

Upgrades from SIMATIC PCS 7 V8.x/V9.0 to V9.1

Upgrades for Operator System incl. OpenPCS 7 as well as Web Option for OS

Ordering data	Article No.	Article No.
<p>5 languages (English, German, French, Italian, Spanish)</p> <p>With SIMATIC PCS 7 Software Media Package</p> <ul style="list-style-type: none"> • Goods delivery License key on USB flash drive, Certificate of License, bundled with 1 x SIMATIC PCS 7 Software Media Package per order item • Online delivery License key download, online Certificate of License, combined with SIMATIC PCS 7 Software Media Package (software download and online Certificate of License) Note: Email address required! <p>ASIA, 2 languages (English, Chinese)</p> <p>With SIMATIC PCS 7 Software Media Package ASIA</p> <ul style="list-style-type: none"> • Goods delivery ASIA license key on USB hardlock, Certificate of License, bundled with 1 x SIMATIC PCS 7 Software Media Package ASIA per order item 	<p>6ES7652-8BX68-0YE0</p> <p>6ES7652-8BX68-0YK0</p> <p>6ES7652-8BX68-0CE0</p>	<p>OS software upgrade from V8.x to V9.1, based on the existing number of POs</p> <p>SIMATIC PCS 7 OS Single Station Upgrade Package V8.x to V9.1 For OS Single Station, software class A, runs with Windows 10 Enterprise 2019 LTSC (see SIMATIC PCS 7 V9.1 Readme for the latest information), single license for 1 installation</p> <p>5 languages (English, German, French, Italian, Spanish)</p> <p>With SIMATIC PCS 7 Software Media Package</p> <ul style="list-style-type: none"> • Goods delivery License key on USB flash drive, Certificate of License, bundled with 1 x SIMATIC PCS 7 Software Media Package per order item • Online delivery License key download, online Certificate of License, combined with SIMATIC PCS 7 Software Media Package (software download and online Certificate of License) Note: Email address required! <p>ASIA, 2 languages (English, Chinese)</p> <p>With SIMATIC PCS 7 Software Media Package ASIA</p> <ul style="list-style-type: none"> • Goods delivery ASIA license key on USB hardlock, Certificate of License, bundled with 1 x SIMATIC PCS 7 Software Media Package ASIA per order item
<p>SIMATIC PCS 7 OS Server SN ASIA Upgrade Package V9.0 to V9.1 For OS Server</p> <p>2 languages (English, Chinese), software class A, runs with Windows Server 2019 Standard Edition 64-bit (see SIMATIC PCS 7 V9.1 Readme for the latest information), single license for 1 installation</p> <p>Without SIMATIC PCS 7 Software Media Package ASIA</p> <ul style="list-style-type: none"> • Goods delivery ASIA license key on USB hardlock, Certificate of License 	<p>6ES7658-8BA68-6CE0</p>	<p>6ES7652-5AX68-0YE0</p> <p>6ES7652-5AX68-0YK0</p> <p>6ES7652-5AX68-0CE0</p>
<p>SIMATIC PCS 7 OS Client/SFC Visualization Upgrade Package V9.0 to V9.1 Software class A, runs with Windows 10 Enterprise 2019 LTSC (see SIMATIC PCS 7 V9.1 Readme for the latest information), floating license for 1 user</p> <p>5 languages (English, German, French, Italian, Spanish)</p> <p>Without SIMATIC PCS 7 Software Media Package</p> <ul style="list-style-type: none"> • Goods delivery License key on USB flash drive, Certificate of License • Online delivery License key download, online Certificate of License Note: Email address required! <p>ASIA, 2 languages (English, Chinese)</p> <p>Without SIMATIC PCS 7 Software Media Package ASIA</p> <ul style="list-style-type: none"> • Goods delivery ASIA license key on USB hardlock, Certificate of License 	<p>6ES7652-8CX68-0YF5</p> <p>6ES7652-8CX68-0YK5</p> <p>6ES7652-8CX68-0CF5</p>	<p>SIMATIC PCS 7 OS Single Station SN ASIA Upgrade Package V8.x to V9.1 (incl. SOFTNET REDCONNECT) For OS Single Station</p> <p>2 languages (English, Chinese), software class A, runs with Windows 10 Enterprise 2019 LTSC (see SIMATIC PCS 7 V9.1 Readme for the latest information), single license for 1 installation</p> <p>Without SIMATIC PCS 7 Software Media Package ASIA</p> <ul style="list-style-type: none"> • Goods delivery ASIA license key on USB hardlock, Certificate of License

Update/upgrade packages

Upgrades from SIMATIC PCS 7 V8.x/V9.0 to V9.1

Upgrades for Operator System incl. OpenPCS 7 as well as Web Option for OS

Ordering data

SIMATIC PCS 7 OS Server Upgrade Package V8.x to V9.1 For OS Server

Software class A, runs with Windows Server 2019 Standard Edition 64-bit (see SIMATIC PCS 7 V9.1 Readme for the latest information), single license for 1 installation

With SIMATIC PCS 7 Software Media Package

5 languages (English, German, French, Italian, Spanish)

With SIMATIC PCS 7 Software Media Package

- Goods delivery
License key on USB flash drive, Certificate of License, bundled with 1 × SIMATIC PCS 7 Software Media Package per order item
- Online delivery
License key download, online Certificate of License, combined with SIMATIC PCS 7 Software Media Package (software download and online Certificate of License)
Note:
Email address required!

ASIA, 2 languages (English, Chinese)

With SIMATIC PCS 7 Software Media Package ASIA

- Goods delivery
ASIA license key on USB hardlock, Certificate of License, bundled with 1 × SIMATIC PCS 7 Software Media Package ASIA per order item

SIMATIC PCS 7 OS Server SN ASIA Upgrade Package V8.x to V9.1 For OS Server

2 languages (English, Chinese), software class A, runs with Windows Server 2019 Standard Edition 64-bit (see SIMATIC PCS 7 V9.1 Readme for the latest information), single license for 1 installation

Without SIMATIC PCS 7 Software Media Package ASIA

- Goods delivery
ASIA license key on USB hardlock, Certificate of License

SIMATIC PCS 7 OS Client/SFC Visualization Upgrade Package V8.x to V9.1

Software class A, runs with Windows 10 Enterprise 2019 LTSC (see SIMATIC PCS 7 V9.1 Readme for the latest information), floating license for 1 user

5 languages (English, German, French, Italian, Spanish)

Without SIMATIC PCS 7 Software Media Package

- Goods delivery
License key on USB flash drive, Certificate of License
- Online delivery
License key download, online Certificate of License
Note:
Email address required!

Article No.

6ES7652-5BX68-0YE0

6ES7652-5BX68-0YK0

6ES7652-5BX68-0CE0

6ES7658-2BA68-6CE0

6ES7652-5CX68-0YF5

6ES7652-5CX68-0YK5

Article No.

ASIA, 2 languages (English, Chinese)

Without SIMATIC PCS 7 Software Media Package ASIA

- Goods delivery
ASIA license key on USB hardlock, Certificate of License

6ES7652-5CX68-0CF5

Web Option for OS

PCS 7 Web Server Upgrade from V9.0 to V9.1

SIMATIC PCS 7 Web Server Upgrade Package V9.0 to V9.1

For SIMATIC PCS 7 Web Server, SIMATIC PCS 7 Web Diagnostics Server, SIMATIC PCS 7 Web Diagnostics Client

6 languages (English, German, French, Italian, Spanish, Chinese), software class A

Runs with the following operating systems (see SIMATIC PCS 7 V9.1 Readme for the latest information):

- Windows Server 2019 Standard Edition 64-bit (Web Server/Web Diagnostics Server)
- Windows 10 Enterprise 2019 LTSC 64-bit (Web Diagnostics Client)

Single license for 1 installation, without SIMATIC PCS 7 Software Media Package

- Goods delivery
License key on USB flash drive, Certificate of License
- Online delivery
License key download, online Certificate of License
Note:
Email address required!

6ES7652-8DX68-0YF0

6ES7652-8DX68-0YK0

PCS 7 Web Server Upgrade from V8.x to V9.1

SIMATIC PCS 7 Web Server Upgrade Package V8.x to V9.1

For SIMATIC PCS 7 Web Server, SIMATIC PCS 7 Web Diagnostics Server, SIMATIC PCS 7 Web Diagnostics Client

6 languages (English, German, French, Italian, Spanish, Chinese), software class A

Runs with the following operating systems (see SIMATIC PCS 7 V9.1 Readme for the latest information):

- Windows Server 2019 Standard Edition 64-bit (Web Server/Web Diagnostics Server)
- Windows 10 Enterprise 2019 LTSC 64-bit (Web Diagnostics Client)

Single license for 1 installation, without SIMATIC PCS 7 Software Media Package

- Goods delivery
License key on USB flash drive, Certificate of License
- Online delivery
License key download, online Certificate of License
Note:
Email address required!

6ES7652-5DX68-0YF0

6ES7652-5DX68-0YK0

Overview**Maintenance Station Upgrade Package**

Using the SIMATIC PCS 7 Maintenance Station Upgrade Package, you can upgrade the SIMATIC PCS 7 Maintenance Station Runtime Basic Package and the SIMATIC PCS 7 Maintenance Station Engineering from V8.x to V9.1 and from V9.0 to V9.1. The SNMP OPC server license is also taken into account for the upgrade.

The cumulative SIMATIC PCS 7 Maintenance Station Runtime licenses are independent of the version. Existing asset TAGs of these licenses are therefore completely available following the upgrade.

Ordering data**Article No.****PCS 7 Maintenance Station Upgrade from V8.x to V9.1****SIMATIC PCS 7 Maintenance Station Upgrade Package V8.x to V9.1**

SIMATIC PCS 7 Maintenance Station Upgrade Package V8.x to V9.1 for installation on SIMATIC PCS 7 BOX, Single Station or Server

6 languages (English, German, French, Italian, Spanish, Chinese), software class A, runs with Windows 10 Enterprise 2019 LTSC and Windows Server 2019 Standard Edition 64-bit (see SIMATIC PCS 7 V9.1 Readme for the latest information), single license for 1 installation

Without SIMATIC PCS 7 Software Media Package

- Goods delivery
License key on USB flash drive, Certificate of License

6ES7652-5FX68-0YFO

- Online delivery
License key download, online Certificate of License

6ES7652-5FX68-0YKO

Note:

Email address required!

PCS 7 Maintenance Station Upgrade from V9.0 to V9.1

SIMATIC PCS 7 Maintenance Station Upgrade Package V9.0 to V9.1 for installation on SIMATIC PCS 7 BOX, Single Station or Server

6 languages (English, German, French, Italian, Spanish, Chinese), software class A, runs with Windows 10 Enterprise 2019 LTSC and Windows Server 2019 Standard Edition 64-bit (see SIMATIC PCS 7 V9.1 Readme for the latest information), single license for 1 installation

Without SIMATIC PCS 7 Software Media Package

- Goods delivery
License key on USB flash drive, Certificate of License

6ES7652-8FX68-0YFO

- Online delivery
License key download, online Certificate of License

6ES7652-8FX68-0YKO

Note:

Email address required!

Update/upgrade packages

Upgrades from SIMATIC PCS 7 V8.x/V9.0 to V9.1

Upgrades for SIMATIC BATCH

Overview

SIMATIC BATCH Upgrade Packages

Upgrades combined in packages allow you to upgrade existing SIMATIC BATCH systems from V8.x or V9.0 to V9.1:

SIMATIC BATCH Server Upgrade Package

With upgrade licenses for:

- SIMATIC BATCH Server
- SIMATIC BATCH Basic
- SIMATIC BATCH single station user
- SIMATIC BATCH single station system
- SIMATIC BATCH API
- PCS 7 BCE
- Industrial Ethernet communication software for CP

SIMATIC BATCH Client Upgrade Package

With upgrade licenses for:

- SIMATIC BATCH Client
- SIMATIC BATCH Recipe System

The cumulative SIMATIC BATCH UNITS are independent of the version. Existing UNITS are completely available following the upgrade.

Ordering data

SIMATIC BATCH Upgrade from V9.0 to V9.1

SIMATIC BATCH Server Upgrade Package V9.0 to V9.1

6 languages (English, German, French, Italian, Spanish, Chinese), software class A, runs with Windows 10 Enterprise 2019 LTSC or Windows Server 2019 Standard Edition 64-bit (see SIMATIC PCS 7 V9.1 Readme for the latest information), single license for 1 installation

Without SIMATIC PCS 7 Software Media Package

- Goods delivery
License key on USB flash drive, Certificate of License
- Online delivery
License key download, online Certificate of License
Note:
Email address required!

6ES7657-8XX68-0YF0

6ES7657-8XX68-0YK0

SIMATIC BATCH Client Upgrade Package V9.0 to V9.1

6 languages (English, German, French, Italian, Spanish, Chinese), software class A, runs with Windows 10 Enterprise 2019 LTSC or Windows Server 2019 Standard Edition 64-bit (see SIMATIC PCS 7 V9.1 Readme for the latest information), floating license for 1 user

Without SIMATIC PCS 7 Software Media Package

- Goods delivery
License key on USB flash drive, Certificate of License
- Online delivery
License key download, online Certificate of License
Note:
Email address required!

6ES7657-8XX68-0YF5

6ES7657-8XX68-0YK5

SIMATIC BATCH Upgrade from V8.x to V9.1

SIMATIC BATCH Server Upgrade Package V8.x to V9.1

6 languages (English, German, French, Italian, Spanish, Chinese), software class A, runs with Windows 10 Enterprise 2019 LTSC or Windows Server 2019 Standard Edition 64-bit (see SIMATIC PCS 7 V9.1 Readme for the latest information), single license for 1 installation

Without SIMATIC PCS 7 Software Media Package

- Goods delivery
License key on USB flash drive, Certificate of License
- Online delivery
License key download, online Certificate of License
Note:
Email address required!

6ES7657-5XX68-0YF0

6ES7657-5XX68-0YK0

SIMATIC BATCH Client Upgrade Package V8.x to V9.1

6 languages (English, German, French, Italian, Spanish, Chinese), software class A, runs with Windows 10 Enterprise 2019 LTSC or Windows Server 2019 Standard Edition 64-bit (see SIMATIC PCS 7 V9.1 Readme for the latest information), floating license for 1 user

Without SIMATIC PCS 7 Software Media Package

- Goods delivery
License key on USB flash drive, Certificate of License
- Online delivery
License key download, online Certificate of License
Note:
Email address required!

6ES7657-5XX68-0YF5

6ES7657-5XX68-0YK5

Overview

SIMATIC Route Control upgrade packages

With SIMATIC Route Control upgrade packages, you can upgrade Route Control Engineering, Route Control Server and Route Control Center from V8.x to V9.1 and from V9.0 to V9.1. The number of existing "Routes" (quantity option for number of simultaneous material transports) is fully available again after the upgrade.

SIMATIC Route Control Center upgrades, which are only available for online delivery, allow you to upgrade the Route Control Center software separately from V8.x to V9.1 and from v9.0 to V9.1.

Ordering data	Article No.	Ordering data	Article No.
SIMATIC Route Control Upgrade from V8.x to V9.1		SIMATIC Route Control Upgrade from V9.0 to V9.1	
SIMATIC Route Control Upgrade Package V8.x to V9.1 6 languages (English, German, French, Italian, Spanish, Chinese), software class A, runs with Windows 10 Enterprise 2019 LTSC or Windows Server 2019 Standard Edition 64-bit (see SIMATIC PCS 7 V9.1 Readme for the latest information), single license for 1 installation Without SIMATIC PCS 7 Software Media Package <ul style="list-style-type: none"> • Goods delivery License key on USB flash drive, Certificate of License • Online delivery License key download, online Certificate of License <u>Note:</u> Email address required! 	6ES7652-5XX68-0YFO 6ES7652-5XX68-0YKO	SIMATIC Route Control Upgrade Package V9.0 to V9.1 6 languages (English, German, French, Italian, Spanish, Chinese), software class A, runs with Windows 10 Enterprise 2019 LTSC or Windows Server 2019 Standard Edition 64-bit (see SIMATIC PCS 7 V9.1 Readme for the latest information), single license for 1 installation Without SIMATIC PCS 7 Software Media Package <ul style="list-style-type: none"> • Goods delivery License key on USB flash drive, Certificate of License • Online delivery License key download, online Certificate of License <u>Note:</u> Email address required! 	6ES7652-8XX68-0YFO 6ES7652-8XX68-0YKO
SIMATIC Route Control Center Upgrade V8.x to V9.1 6 languages (English, German, French, Italian, Spanish, Chinese), software class A, runs with Windows 10 Enterprise 2019 LTSC or Windows Server 2019 Standard Edition 64-bit (see SIMATIC PCS 7 V9.1 Readme for the latest information), floating license for 1 user Without SIMATIC PCS 7 Software Media Package <ul style="list-style-type: none"> • Online delivery License key download, online Certificate of License <u>Note:</u> Email address required! 	6ES7658-7EX68-0YKO	SIMATIC Route Control Center Upgrade V9.0 to V9.1 6 languages (English, German, French, Italian, Spanish, Chinese), software class A, runs with Windows 10 Enterprise 2019 LTSC or Windows Server 2019 Standard Edition 64-bit (see SIMATIC PCS 7 V9.1 Readme for the latest information), floating license for 1 user Without SIMATIC PCS 7 Software Media Package <ul style="list-style-type: none"> • Online delivery License key download, online Certificate of License <u>Note:</u> Email address required! 	6ES7658-8EX68-0YKO

Update/upgrade packages

Upgrades from SIMATIC PCS 7 V8.x/V9.0 to V9.1

Operating System Packages for SIMATIC Process Control System IPC

Overview

Operating System Packages for SIMATIC Process Control System IPC

For the SIMATIC Process Control System IPCs listed below, different Operating System Packages are offered to upgrade existing SIMATIC Process Control System IPCs to Microsoft Windows 10 Enterprise 2019 LTSC and Microsoft Windows Server 2019 Standard.

- Operating System Package with Restore USB flash drive: Contains the license label (COA) and the Restore data storage medium for the respective SIMATIC Process Control System IPC
- Operating System Package without Restore USB flash drive: Contains only a license label (COA) for the SIMATIC Process Control System IPC

Upgrading of only one SIMATIC Process Control System IPC requires the package with the Restore USB flash drive.

If multiple SIMATIC Process Control System IPCs are to be upgraded, the costs can be reduced by purchasing the Operating System Packages without Restore USB flash drive.

This means that the package with the Restore USB flash drive is needed at least once. This Restore USB flash drive can then also be used for other SIMATIC Process Control System IPCs of the same type.

Licensing of the other SIMATIC Process Control System IPCs (of the same type) is by acquiring the packages, which contain only the license label (COA).

Of course, the package with the Restore USB flash drive can also be procured for each of the SIMATIC Process Control System IPCs.

Components of packages with Restore USB Flash Drive:

- Restore data storage medium corresponding to the respective IPC
- License label (COA)
- Certificate of License (COL)

Components of packages without Restore USB Flash Drive:

- License label (COA)
- Certificate of License (COL)

With the Restore USB flash drive, the operating system is transferred to the SIMATIC Process Control System IPC through the familiar restore process. You can find more information in the supplied documentation and on the Restore USB flash drive.

The SIMATIC Process Control System IPC Operating System Packages require activation (online or by telephone) with Microsoft.

Delivered in a foil envelope. This reduces packaging material and the size of shipping packaging, especially when ordering multiple Operating System Packages.

Ordering data	Article No.	Article No.
SIMATIC Process Control System IPC – Operating System Packages		
SIMATIC Process Control System IPC – Operating System Packages		
SIMATIC Process Control System IPC547G - Operating System Package Software class B, single license for 1 installation COA sticker and USB flash drive with Restore Image A1 (operating system only) Reference HW: IPC547G - 6ES7660-7*	6ES7650-4MB00-0UA0	
<ul style="list-style-type: none"> • Microsoft® Windows® 10 IoT Enterprise 2019 LTSC, 64-bit 	6ES7650-4MB00-0UB0	
<ul style="list-style-type: none"> • Microsoft® Windows® Server IoT 2019 Standard, 16-core, 5 clt, 64-bit 		
SIMATIC Process Control System IPC647D / IPC847D - Operating System Package Software class B, single license for 1 installation COA sticker and USB flash drive with Restore Image A1 (operating system only) Reference HW: IPC647D - 6ES7660-5* IPC847D - 6ES7660-6*	6ES7650-4MB00-1UA0	
<ul style="list-style-type: none"> • Microsoft® Windows® 10 IoT Enterprise 2019 LTSC, 64-bit 	6ES7650-4MB00-1UB0	
<ul style="list-style-type: none"> • Microsoft® Windows® Server IoT 2019 Standard, 16-core, 5 clt, 64-bit 		
SIMATIC Process Control System IPC647E / IPC847E - Operating System Package Software class B, single license for 1 installation COA sticker and USB flash drive with Restore Image A1 / A2 (operating system + SIMATIC PCS 7 V9.1) Reference HW: IPC647E - 6ES7661-0*, 6ES7650-0XH03-*YA0; IPC847E - 6ES7661-1*, 6ES7650-0XH03-*YB0	6ES7650-4MB00-3UA0	
<ul style="list-style-type: none"> • Microsoft® Windows® 10 IoT Enterprise 2019 LTSC, 64-bit 	6ES7650-4MB00-3UB0	
<ul style="list-style-type: none"> • Microsoft® Windows® Server IoT 2019 Standard, 16-core, 5 clt, 64-bit 		
SIMATIC Process Control System IPC627D / IPC677D - Operating System Package Software class B, single license for 1 installation COA sticker and USB flash drive with Restore Image A1 (operating system only) Reference HW: IPC627D / IPC677D - 6ES7650-4B*	6ES7650-4MB00-2UA0	
<ul style="list-style-type: none"> • Microsoft® Windows® 10 IoT Enterprise 2019 LTSC, 64-bit 		
SIMATIC Process Control System IPC427E / IPC477E - Operating System Package Software class B, single license for 1 installation COA sticker and USB flash drive with Restore Image A1 / A2 (operating system + SIMATIC PCS 7 V9.1) Reference HW: IPC427E / IPC477E - 6ES7650-0VG*	6ES7650-4MB00-4UA0	
<ul style="list-style-type: none"> • Microsoft® Windows® 10 IoT Enterprise 2019 LTSC, 64-bit 		
SIMATIC Process Control System IPC - Operating System Packages Software class B, single license for 1 installation COA sticker only (without Restore USB flash drive)	6ES7650-4MB00-8XA0	
<ul style="list-style-type: none"> • Microsoft® Windows® 10 IoT Enterprise 2019 LTSC, 64-bit Reference HW: IPC547G - 6ES7660-7* IPC647D - 6ES7660-5* IPC847D - 6ES7660-6* IPC647E - 6ES7661-0*, 6ES7650-0XH03-.YA0 IPC847E - 6ES7661-1*, 6ES7650-0XH03-.YB0 IPC627D / IPC677D - 6ES7650-4B* IPC427E / IPC477E - 6ES7650-0VG*	6ES7650-4MB00-8XB0	
<ul style="list-style-type: none"> • Microsoft® Windows® Server IoT 2019 Standard, 16-core, 5 clt, 64-bit Reference HW: IPC547G - 6ES7660-7* IPC647D - 6ES7660-5* IPC847D - 6ES7660-6* IPC647E - 6ES7661-0*, 6ES7650-0XH03-.YA0 IPC847E - 6ES7661-1*, 6ES7650-0XH03-.YB0		

Update/upgrade packages

Upgrades for SIMATIC PCS 7 V8.x to V9.0

Upgrades for Engineering System and Management Console

Overview

Engineering upgrade package AS/OS V8.x to V9.0

The SIMATIC PCS 7 Engineering System with Engineering Software V8.x and Management Console V8.x can be upgraded to Version 9.0 using the SIMATIC PCS 7 Engineering upgrade package AS/OS.

The licenses included in the Engineering upgrade package AS/OS V8.x to V9.0 apply to the following SIMATIC PCS 7 software products:

- PCS 7 ES Single Station, PCS 7 AS Engineering Software, PCS 7 AS/OS Engineering Software
- PCS 7 Import-Export Assistant
- SIMATIC Version Cross Manager
- SIMATIC Version Trail
- PCS 7 SFC Visualization
- PCS 7 BCE
- PCS 7 Management Console
- Industrial Ethernet communication software for CP

SIMATIC PCS 7 ES Single Station SN ASIA upgrade package V8.x to V9.0

The ASIA regional product version "SIMATIC PCS 7 ES Single Station SN ASIA" that comes with communication software SOFTNET-REDCONNECT can be upgraded to V9.0 with the SIMATIC PCS 7 ES single station SN ASIA upgrade package specifically designed for this purpose.

SIMATIC PCS 7 Logic Matrix Upgrade

A separate upgrade is available for upgrading the SIMATIC PCS 7 Logic Matrix Viewer to V9.0.

SIMATIC Version Cross Manager Upgrade

The further developed SIMATIC Version Cross Manager V9.0 is available for use in SIMATIC PCS 7 V9.0. The upgrade to SIMATIC Version Cross Manager V9.0 is part of the Engineering upgrade package AS/OS V8.x to V9.0.

Advanced Engineering System Upgrade

The SIMATIC PCS 7 Advanced Engineering System V8.0 (incl. SP) can be used in SIMATIC PCS 7 V8.0, V8.1, V8.2 and V9.0. Consequently, there is no need to offer a SIMATIC PCS 7 Advanced Engineering System upgrade package for upgrading to V9.0.

Ordering data

Article No.

Article No.

Engineering software

Engineering Software Upgrade from V8.x to V9.0, based on the existing number of POs

SIMATIC PCS 7 Engineering upgrade package AS/OS V8.x to V9.0

Software class A, runs with Windows 7 Ultimate 64-bit, Windows 10 Enterprise 2015 LTSC 64-bit or Windows Server 2012 R2 Standard 64-bit (see SIMATIC PCS 7 V9.0 Readme for the latest information), floating license for 1 user

5 languages (English, German, French, Italian, Spanish)

With SIMATIC PCS 7 Software Media Package

- Goods delivery
License key on USB flash drive, certificate of license, bundled with 1 × SIMATIC PCS 7 Software Media Package per order item

6ES7651-5AX58-0YE5

- Online delivery
License key download, online certificate of license, combined with SIMATIC PCS 7 Software Media Package (software download and online certificate of license)

6ES7651-5AX58-0YK5

Note:
Email address required!

ASIA, 2 languages (English, Chinese)

With SIMATIC PCS 7 Software Media Package ASIA

- Goods delivery
ASIA license key on USB hardlock, certificate of license, bundled with 1 × SIMATIC PCS 7 Software Media Package ASIA per order item

6ES7651-5AX58-0CE5

SIMATIC PCS 7 ES Single Station SN ASIA upgrade package V8.x to V9.0 (including SOFTNET REDCONNECT)

2 languages (English, Chinese), software class A, runs with Windows 7 Ultimate 64-bit, Windows 10 Enterprise 2015 LTSC 64-bit or Windows Server 2012 R2 Standard 64-bit (see SIMATIC PCS 7 V9.0 Readme for the latest information), single license for 1 installation

Without SIMATIC PCS 7 Software Media Package ASIA

- Goods delivery
ASIA license key on USB hardlock, certificate of license

6ES7651-5AA58-6CE0

SIMATIC PCS 7 Logic Matrix Upgrade from V8.2 to V9.0

SIMATIC PCS 7 Logic Matrix Viewer Upgrade from V8.2 to V9.0

Runtime software, 2 languages (English, German), software class A, runs with Windows 7 Ultimate 64-bit, Windows 10 Enterprise 2015 LTSC 64-bit or Windows Server 2012 R2 Standard 64-bit (see SIMATIC PCS 7 V9.0 Readme for the latest information), single license for 1 installation

Without SIMATIC PCS 7 Software Media Package

- Goods delivery
License key on USB flash drive and certificate of license

6ES7658-1JB58-2YE0

Update/upgrade packages

Upgrades for SIMATIC PCS 7 V8.x to V9.0

Upgrades for Operator System incl. OpenPCS 7 and Web Option for OS

Overview

Upgrades combined in packages allow existing Operator Systems to be upgraded from V8.x to V9.0 in line with the number of existing process objects and archive tags.

OS software upgrades from V8.x to V9.0

The following upgrade packages for upgrading to V9.0 will be offered for SIMATIC PCS 7 operator stations with OS software V8.x:

- SIMATIC PCS 7 OS Single Station upgrade package
- SIMATIC PCS 7 OS Server upgrade package
- SIMATIC PCS 7 OS Client/SFC Visualization upgrade package

The ASIA product versions "SIMATIC PCS 7 OS Single Station SN ASIA" and "SIMATIC PCS 7 OS Server SN ASIA" that come with communication software SOFTNET-REDCONNECT can be upgraded to V9.0 with specific upgrade packages:

- SIMATIC PCS 7 OS Single Station SN ASIA upgrade package
- SIMATIC PCS 7 OS Server SN ASIA upgrade package

Two upgrade packages of type OS Single Station or OS Server are required in each case for redundant SIMATIC PCS 7 Operator Stations.

In addition to the licenses for the PCS 7 OS Software Single Station or Server, the upgrade packages for OS Single Station and OS Server include upgrade licenses for:

- SIMATIC PCS 7 SFC Visualization
- SIMATIC PCS 7 BCE
- Industrial Ethernet communication software for CP
- SIMATIC PCS 7 OpenPCS 7 and SIMATIC PCS 7 OpenPCS 7/OS Client

The upgrade license for SIMATIC PCS 7 SFC Visualization is also part of the upgrade package SIMATIC PCS 7 OS Client/SFC Visualization.

With a SIMATIC PCS 7 OS Server upgrade package, only one SIMATIC PCS 7 OS Server can be upgraded.

Upgrade of the Web Option for OS

Using the SIMATIC PCS 7 OS Web Server upgrade package, you can upgrade the SIMATIC PCS 7 Web server, SIMATIC PCS 7 Web diagnostics server and SIMATIC PCS 7 Web diagnostics clients from V8.x to V9.0.

Ordering data

Article No.

Article No.

OS software

OS software upgrade from V8.x to V9.0, based on the existing number of POs

SIMATIC PCS 7 OS single station upgrade package V8.x to V9.0

For OS single station, software class A, runs with Windows 7 Ultimate 64-bit or Windows 10 Enterprise 2015 LTSC 64-bit (see SIMATIC PCS 7 V9.0 Readme for the latest information), single license for 1 installation

5 languages (English, German, French, Italian, Spanish)

With SIMATIC PCS 7 Software Media Package

- Goods delivery
License key on USB flash drive, certificate of license, bundled with 1 × SIMATIC PCS 7 Software Media Package per order item
- Online delivery
License key download, online certificate of license, combined with SIMATIC PCS 7 Software Media Package (software download and online certificate of license)
Note:
Email address required!

ASIA, 2 languages (English, Chinese)

With SIMATIC PCS 7 Software Media Package ASIA

- Goods delivery
ASIA license key on USB hardlock, certificate of license, bundled with 1 × SIMATIC PCS 7 Software Media Package ASIA per order item

6ES7652-5AX58-0YE0

6ES7652-5AX58-0YK0

6ES7652-5AX58-0CE0

SIMATIC PCS 7 OS Single Station SN ASIA upgrade package V8.x to V9.0 (including SOFTNET REDCONNECT)

For OS Single Station

2 languages (English, Chinese), software class A, runs with Windows 7 Ultimate 64-bit or Windows 10 Enterprise 2015 LTSC 64-bit (see SIMATIC PCS 7 V9.0 Readme for the latest information), single license for 1 installation

Without SIMATIC PCS 7 Software Media Package ASIA

- Goods delivery
ASIA license key on USB hardlock, certificate of license

6ES7658-2AA58-6CE0

Update/upgrade packages

Upgrades for SIMATIC PCS 7 V8.x to V9.0

Upgrades for Operator System incl. OpenPCS 7 and Web Option for OS

Ordering data

Article No.

Article No.

SIMATIC PCS 7 OS Server upgrade package V8.x to V9.0

For OS Server

Software class A, runs with Windows Server 2012 R2 Standard 64-bit (see SIMATIC PCS 7 V9.0 Readme for the latest information), single license for 1 installation

With SIMATIC PCS 7 Software Media Package

5 languages (English, German, French, Italian, Spanish)

With SIMATIC PCS 7 Software Media Package

- Goods delivery
License key on USB flash drive, certificate of license, bundled with 1 × SIMATIC PCS 7 Software Media Package per order item
- Online delivery
License key download, online certificate of license, combined with SIMATIC PCS 7 Software Media Package (software download and online certificate of license)
Note:
Email address required!

ASIA, 2 languages (English, Chinese)

With SIMATIC PCS 7 Software Media Package ASIA

- Goods delivery
ASIA license key on USB hardlock, certificate of license, bundled with 1 × SIMATIC PCS 7 Software Media Package ASIA per order item

6ES7652-5BX58-0YE0

6ES7652-5BX58-0YK0

6ES7652-5BX58-0CE0

SIMATIC PCS 7 OS Server SN ASIA upgrade package V8.x to V9.0

For OS Server

2 languages (English, Chinese), software class A, runs with Windows Server 2012 R2 Standard 64-bit (see SIMATIC PCS 7 V9.0 Readme for the latest information), single license for 1 installation

Without SIMATIC PCS 7 Software Media Package ASIA

- Goods delivery
ASIA license key on USB hardlock, certificate of license

6ES7658-2BA58-6CE0

SIMATIC PCS 7 OS Client/SFC Visualization upgrade package V8.x to V9.0

Software class A, runs with Windows 7 Ultimate 64-bit, Windows 10 Enterprise 2015 LTSC 64-bit or Windows Server 2012 R2 Standard 64-bit (see SIMATIC PCS 7 V9.0 Readme for the latest information), floating license for 1 user

5 languages (English, German, French, Italian, Spanish)

Without SIMATIC PCS 7 Software Media Package

- Goods delivery
License key on USB flash drive, certificate of license
- Online delivery
License key download, online certificate of license
Note:
Email address required!

ASIA, 2 languages (English, Chinese)

Without SIMATIC PCS 7 Software Media Package ASIA

- Goods delivery
ASIA license key on USB hardlock, certificate of license

6ES7652-5CX58-0YF5

6ES7652-5CX58-0YK5

6ES7652-5CX58-0CF5

Web Option for OS

PCS 7 Web Server Upgrade from V8.x to V9.0

SIMATIC PCS 7 Web Server upgrade package V8.x to V9.0

For SIMATIC PCS 7 Web Server, SIMATIC PCS 7 Web Diagnostics Server, SIMATIC PCS 7 Web Diagnostics client

6 languages (English, German, French, Italian, Spanish, Chinese), software class A

Runs with the following operating systems (see SIMATIC PCS 7 V9.0 Readme for latest information):

- Windows Server 2012 R2 Standard 64-bit (Web server/Web diagnostics server)
- Windows 7 Ultimate 64-bit, Windows 10 Enterprise 2015 LTSC 64-bit (Web diagnostics client)

Single license for 1 installation, without SIMATIC PCS 7 Software Media Package

- Goods delivery
License key on USB flash drive, certificate of license
- Online delivery
License key download, online certificate of license
Note:
Email address required!

6ES7652-5DX58-0YF0

6ES7652-5DX58-0YK0

Update/upgrade packages

Upgrades for SIMATIC PCS 7 V8.x to V9.0

Upgrades for Process Historian and Information Server

Overview

You can upgrade the following products from V8.x to version V9.0 with the SIMATIC PCS 7 PH/IS Upgrade Package:

- Process Historian and Information Server V8.0/V8.1/V8.2 (bundle license)
- Process Historian Archive - BATCH V8.0/V8.1/V8.2
- Process Historian Server Redundancy V8.0/V8.1/V8.2 (bundle license, upgrade package is required 2x)
- Information Server V8.0
- Process Historian Server V8.0

Ordering data

Article No.

PCS 7 Process Historian and Information Server upgrade from V8.x to V9.0

SIMATIC PCS 7 PH/IS Upgrade Package V8.x to V9.0

5 languages (English, German, French, Italian, Spanish), software class A, runs with Windows Server 2012 R2 Standard 64-bit (see SIMATIC PCS 7 V9.0 Readme for latest information), single license for 1 installation

Without SIMATIC PCS 7 Software Media Package

- Goods delivery
License key on USB flash drive, certificate of license
- Online delivery
License key download, online certificate of license

Note:

Email address required!

6ES7652-7AX58-2YE0

6ES7652-7AX58-2YK0

Update/upgrade packages

Upgrades for SIMATIC PCS 7 V8.x to V9.0

Upgrades for Maintenance Station

Overview

Maintenance Station Upgrade Package

Using the SIMATIC PCS 7 Maintenance Station Upgrade Package, you can upgrade the SIMATIC PCS 7 Maintenance Station Runtime Basic Package and the SIMATIC PCS 7 Maintenance Station Engineering from V8.x to V9.0. The SNMP OPC server license is also taken into account for the upgrade.

The cumulative SIMATIC PCS 7 Maintenance Station Runtime licenses are independent of the version. Existing asset TAGs of these licenses are therefore completely available following the upgrade.

Ordering data

Article No.

PCS 7 Maintenance Station upgrade from V8.x to V9.0

SIMATIC PCS 7 Maintenance Station Upgrade Package V8.x to V9.0

For installation on SIMATIC PCS 7 BOX, single station or server

6 languages (English, German, French, Italian, Spanish, Chinese), software class A, runs with Windows 7 Ultimate 64-bit, Windows 10 Enterprise 2015 LTSB 64-bit or Windows Server 2012 R2 Standard 64-bit, single license for 1 installation

Without SIMATIC PCS 7 Software Media Package

- Goods delivery
License key on USB flash drive, certificate of license

6ES7652-5FX58-0YF0

- Online delivery
License key download, online certificate of license

6ES7652-5FX58-0YK0

Note:
Email address required!

Overview

SIMATIC BATCH Upgrade Packages

Upgrades combined in packages allow you to upgrade existing SIMATIC BATCH systems from V8.x to V9.0:

SIMATIC BATCH Server Upgrade Package

With upgrade licenses for:

- SIMATIC BATCH Server
- SIMATIC BATCH Basic
- SIMATIC BATCH Single Station User
- SIMATIC BATCH Single Station System
- SIMATIC BATCH API
- PCS 7 BCE
- Industrial Ethernet communication software for CP

SIMATIC BATCH Client upgrade package

With upgrade licenses for:

- SIMATIC BATCH Client
- SIMATIC BATCH Recipe System

The cumulative SIMATIC BATCH UNITS are independent of the version. Existing UNITS are completely available following the upgrade.

Ordering data

Article No.

SIMATIC BATCH upgrade from V8.x to V9.0

SIMATIC BATCH Server Upgrade Package V8.x to V9.0

6 languages (English, German, French, Italian, Spanish, Chinese), software class A, runs with Windows 7 Ultimate 64-bit, Windows 10 Enterprise 2015 LTSB 64 Bit or Windows Server 2012 R2 Standard 64-bit (see SIMATIC PCS 7 V9.0 Readme for the latest information), single license for 1 installation
Without SIMATIC PCS 7 Software Media Package

- Goods delivery
License key on USB flash drive, certificate of license
- Online delivery
License key download, online certificate of license
Note:
Email address required!

6ES7657-5XX58-0YF0

6ES7657-5XX58-0YK0

SIMATIC BATCH Client Upgrade Package V8.x to V9.0

6 languages (English, German, French, Italian, Spanish, Chinese), software class A, runs with Windows 7 Ultimate 64-bit, Windows 10 Enterprise 2015 LTSB 64 Bit or Windows Server 2012 R2 Standard 64-bit (see SIMATIC PCS 7 V9.0 Readme for the latest information), floating license for 1 user
Without SIMATIC PCS 7 Software Media Package

- Goods delivery
License key on USB flash drive, certificate of license
- Online delivery
License key download, online certificate of license
Note:
Email address required!

6ES7657-5XX58-0YF5

6ES7657-5XX58-0YK5

Update/upgrade packages

Upgrades for SIMATIC PCS 7 V8.x to V9.0

Upgrades for SIMATIC Route Control

Overview

SIMATIC Route Control upgrade packages

With SIMATIC Route Control upgrade packages, you can upgrade Route Control Engineering, Route Control Server and Route Control Center from V8.x to V9.0. The number of existing "Routes" (quantity option for number of simultaneous material transports) is fully available again after the upgrade.

SIMATIC Route Control Center upgrades, which are only available for online delivery, allow you to upgrade the Route Control Center software separately from V8.x to V9.0.

Ordering data

Article No.

SIMATIC Route Control upgrade from V8.x to V9.0

SIMATIC Route Control Upgrade Package V8.x to V9.0

6 languages (English, German, French, Italian, Spanish, Chinese), software class A, runs with Windows 7 Ultimate 64-bit, Windows 10 Enterprise 2015 LTSB 64 Bit or Windows Server 2012 R2 Standard 64-bit (see SIMATIC PCS 7 V9.0 Readme for the latest information), single license for 1 installation

Without SIMATIC PCS 7 Software Media Package

- Goods delivery
License key on USB flash drive, certificate of license
- Online delivery
License key download, online certificate of license
Note:
Email address required!

6ES7652-5XX58-0YFO

6ES7652-5XX58-0YKO

SIMATIC Route Control Center upgrade V8.x to V9.0

6 languages (English, German, French, Italian, Spanish, Chinese), software class A, runs with Windows 7 Ultimate 64-bit, Windows 10 Enterprise 2015 LTSB 64 Bit or Windows Server 2012 R2 Standard 64-bit (see SIMATIC PCS 7 V9.0 Readme for the latest information), floating license for 1 user

Without SIMATIC PCS 7 Software Media Package

- Online delivery
License key download, online certificate of license
Note:
Email address required!

6ES7658-7EX58-0YKO

Overview

SIMATIC Logon is a central user administration system with access control which was introduced into the process control system as of SIMATIC PCS 7 V6.0. Up to and including V6.1, SIMATIC Logon was offered in the form of separate products whose version cycle was asynchronous to the version cycle of SIMATIC PCS 7.

As of SIMATIC PCS 7 V7.0, the SIMATIC Logon software and licenses are fully integrated in the process control system. Since then, updating is carried out synchronous with SIMATIC PCS 7.

With the online compatibility tool, you can determine the SIMATIC Logon versions that are suitable for the various SIMATIC PCS 7 versions:

<https://support.industry.siemens.com/cs/ww/en/view/64847781>

Ordering data**SIMATIC Logon Upgrade to V1.6**

7 languages (English, German, French, Italian, Spanish, Chinese and Japanese), software class A

Runs with the following operating systems

- Windows Vista (Business/Enterprise/Ultimate) up to SP2 32/64-bit
- Windows 7 (Professional/Enterprise/Ultimate) up to SP1 32/64-bit
- Windows 8.0 (Standard/Pro/Enterprise) 32/64-bit
- Windows 8.1 (Standard/Pro/Enterprise) 32/64-bit
- Windows 10 Enterprise 2015 LTSB 64-bit
- Windows Server 2003 SP1/SP2 32-bit
- Windows Server 2003 R2/2003 R2 SP2 32-bit
- Windows Server 2008 (Standard/Enterprise/Datacenter) up to SP2 32/64-bit
- Windows Server 2008 R2 (Standard/Enterprise/Datacenter) up to SP1 64-bit
- Windows Server 2012 (Foundation/Essentials/Standard/Datacenter) 64-bit
- Windows Server 2012 R2 (Essentials/Standard/Datacenter) 64-bit

Single license for 1 installation

Goods delivery package: License key on USB flash drive, certificate of license, software and electronic documentation on CD

Article No.

6ES7658-7BX61-0YE0

Update/upgrade packages

Updates/Upgrades Asynchronous to the PCS 7 Version

Upgrades for SIMATIC PDM

Overview

SIMATIC PDM can be integrated in the engineering system, i.e. in the configuration environment of SIMATIC PCS 7, or operated in stand-alone mode. The version cycle of SIMATIC PDM is asynchronous to the version cycle of SIMATIC PCS 7:

The following overview shows some of the SIMATIC PDM versions and the compatible SIMATIC PCS 7 versions:

SIMATIC PDM version	Compatible SIMATIC PCS 7 version
V9.2	V8x, V9x
V9.1	V9.0
V9.0	V8.2 V8.1, V8.1+SP1 V8.0+SP2 (without Communication FOUNDATION Fieldbus)
V8.2	V8.0+SP2, V8.1, V8.1+SP1
V8.1	V8.0, V8.0+SP1/SP2
V6.1	V6.1, V7.1 and V8.0

The compatibility tool on the Internet provides detailed information on how the various SIMATIC PCS 7 versions correlate with the versions of SIMATIC PDM:

<https://support.industry.siemens.com/cs/ww/en/view/64847781>

Existing installations with SIMATIC PDM V7.0 can only be upgraded to version 9.2 by first upgrading to version 8.0. Projects based on SIMATIC PDM V8.x/9.0 (including SP in each case) can be upgraded directly to V9.2 with upgrade packages. Alternatively, an upgrade is also possible via the Software Update Service (for details, see "Software Media and Logistics" chapter, "Software Update Service" section).

Two upgrade packages are offered for SIMATIC PDM V8.x/V9.0:

- SIMATIC PDM Upgrade Package Basic¹⁾ (with/without SIMATIC PDM HART Server option) for configurations based on:
 - SIMATIC PDM Basic
 - SIMATIC PDM Service
 - SIMATIC PDM S7
 - SIMATIC PDM PCS 7
- SIMATIC PDM Upgrade Package Complete¹⁾ for configurations based on:
 - SIMATIC PDM PCS 7 Server
 - SIMATIC PDM PCS 7-FF

¹⁾ Optional product components for SIMATIC PDM such as PDM Extended, PDM Integration in STEP 7/PCS 7, PDM Routing, PDM Server and PDM Communication FOUNDATION Fieldbus are each included in a product package listed in the SIMATIC PDM Upgrade Package Basic or SIMATIC PDM Upgrade Package Complete and are implicitly authorized to be updated via the corresponding license. The SIMATIC PDM Upgrade Package Complete is required for use of the product components PDM Server or PDM Communication FOUNDATION Fieldbus.

Ordering data

Article No.

SIMATIC PDM upgrade/update service

SIMATIC PDM Upgrade Package V6.x to V9.1

For product packages and optional product components of SIMATIC PDM V6.0/V6.1

6 languages (English, German, French, Italian, Spanish, Chinese), software class A, runs with Windows 7 Ultimate 64-bit, Windows 10 Enterprise 2015 LTSB 64-bit, Windows Server 2008 R2 Standard 64-bit or Windows Server 2012 R2 Standard 64-bit (see SIMATIC PDM V9.1 Readme for latest information), floating license for 1 user

Without SIMATIC PCS 7 Software Media Package

- Goods delivery
License key on USB flash drive and certificate of license, bundled with 1 x SIMATIC PDM Software Media Package per order item
- Online delivery
License key download and online certificate of license combined with SIMATIC PDM Software Media Package (SIMATIC PDM and device library software download)

Note:

Email address required!

6ES7651-5CX68-0YE5

6ES7651-5CX68-0YK5

SIMATIC PDM Upgrade Package Basic from V8.x/V9.0 to V9.2

For configurations based on SIMATIC PDM Basic, Service, S7, PCS 7 (with/without SIMATIC PDM HART Server)

6 languages (English, German, French, Italian, Spanish, Chinese), software class A, runs with Windows 10 Enterprise 2019 LTSB 64 Bit or Windows Server 2019 Standard Edition 64 Bit (see SIMATIC PDM V9.1 Readme for latest information), floating license for 1 user

Without SIMATIC PCS 7 Software Media Package

- Goods delivery
License key on USB flash drive and certificate of license, bundled with 1 x SIMATIC PDM Software Media Package per order item

6ES7651-5EX78-0YE5

Ordering data	Article No.	Article No.	
<p>SIMATIC PDM Upgrade Package Basic from V8.x/V9.0 to V9.1 For configurations based on SIMATIC PDM Basic, Service, S7, PCS 7 (with/without SIMATIC PDM HART Server)</p> <p>6 languages (English, German, French, Italian, Spanish, Chinese), software class A, runs with Windows 7 Ultimate 64-bit, Windows 10 Enterprise 2015 LTSC 64-bit, Windows Server 2008 R2 Standard 64-bit or Windows Server 2012 R2 Standard 64-bit (see SIMATIC PDM V9.1 Readme for latest information), floating license for 1 user</p> <p>Without SIMATIC PCS 7 Software Media Package</p> <ul style="list-style-type: none"> • Goods delivery License key on USB flash drive and certificate of license, bundled with 1 × SIMATIC PDM Software Media Package per order item • Online delivery License key download and online certificate of license combined with SIMATIC PDM Software Media Package (SIMATIC PDM and device library software download) Note: Email address required! 	<p>6ES7651-5EX68-0YE5</p> <p>6ES7651-5EX68-0YK5</p>	<p>SIMATIC PDM Upgrade Package Complete from V8.x/V9.0 to V9.1 For configurations based on SIMATIC PDM PCS 7 Server, PCS 7-FF</p> <p>6 languages (English, German, French, Italian, Spanish, Chinese), software class A, runs with Windows 7 Ultimate 64-bit, Windows 10 Enterprise 2015 LTSC 64-bit, Windows Server 2008 R2 Standard 64-bit or Windows Server 2012 R2 Standard 64-bit (see SIMATIC PDM V9.1 Readme for latest information), single license for 1 installation</p> <p>Without SIMATIC PCS 7 Software Media Package</p> <ul style="list-style-type: none"> • Goods delivery License key on USB flash drive and certificate of license, bundled with 1 × SIMATIC PDM Software Media Package per order item • Online delivery License key download and online certificate of license combined with SIMATIC PDM Software Media Package (SIMATIC PDM and device library software download) Note: Email address required! 	<p>6ES7651-5FX68-0YE5</p> <p>6ES7651-5FX68-0YK5</p>
<p>SIMATIC PDM Upgrade Package Complete from V8.x/V9.0 to V9.2 For configurations based on SIMATIC PDM PCS 7 Server, PCS 7-FF</p> <p>6 languages (English, German, French, Italian, Spanish, Chinese), software class A, runs with Windows 10 Enterprise 2019 LTSC 64 Bit or Windows Server 2019 Standard Edition 64 Bit (see SIMATIC PDM V9.1 Readme for latest information), single license for 1 installation</p> <p>Without SIMATIC PCS 7 Software Media Package</p> <ul style="list-style-type: none"> • Goods delivery License key on USB flash drive and certificate of license, bundled with 1 × SIMATIC PDM Software Media Package per order item 	<p>6ES7651-5FX78-0YE5</p>	<p>SIMATIC PDM Upgrade from V7.0 to V8.0 For product configurations based on SIMATIC PDM PCS 7, SIMATIC PDM PCS 7-FF or SIMATIC PDM S7</p> <p>6 languages (English, German, French, Italian, Spanish, Chinese), software class A, runs with Windows 7 Ultimate 32/64-bit, Windows Server 2003 R2 Standard 32-bit or Windows Server 2008 R2 Standard 64-bit, floating license for 1 user</p> <p>Without SIMATIC PCS 7 Software Media Package</p> <ul style="list-style-type: none"> • Goods delivery SIMATIC PDM V8.0 software and device library on DVD, license key on USB flash drive, certificate of license • Online delivery Software image download (SIMATIC PDM and device library), license key download, online certificate of license Note: Email address required! 	<p>6ES7651-5DX08-0YE5</p> <p>6ES7651-5DX08-0YK5</p>

Update/upgrade packages

Updates/Upgrades Asynchronous to the PCS 7 Version

Upgrades for Safety Integrated for Process Automation

Overview

SIMATIC S7 F Systems and SIMATIC S7 Safety Matrix software products can be optionally integrated in the process control system for the implementation and operation of safety applications.

The version cycle of these software components is not synchronous with that of SIMATIC PCS 7, however.

SIMATIC PCS 7 version	Compatible versions	
	SIMATIC S7 F Systems	SIMATIC S7 Safety Matrix Tool, SIMATIC Safety Matrix Viewer
V8.1, V8.2, V9.0	V6.1 SP2 or higher V6.2 V6.3	V6.2 SP2 or higher

Compatibility tool

With the compatibility tool on the Internet you can determine which SIMATIC S7 F Systems and SIMATIC S7 Safety Matrix versions are currently suitable for the various SIMATIC PCS 7 versions:

<https://support.industry.siemens.com/cs/ww/en/view/64847781>

Ordering data

Article No.

SIMATIC S7 F Systems

SIMATIC S7 F Systems V6.3 Upgrade Package

For SIMATIC S7 F Systems upgrade from V6.2 to V6.3

2 languages (English, German), software class A, runs on the following operating systems: MS Windows 10 Enterprise 2015 LTSC 64-bit, MS Windows 10 Enterprise 2019 LTSC 64-bit, MS Windows Server 2012 R2 Update Standard Edition 64-bit, MS Windows Server 2016 Standard Edition 64-bit, MS Windows Server 2016 Datacenter Edition 64-bit, Floating License for 1 user

Without SIMATIC PCS 7 Software Media Package

- Goods delivery
License key on USB flash drive and Certificate of License, bundled with 1 x SIMATIC S7 F Systems Software Media Package per order item
- Online delivery
License key download and online Certificate of License combined with SIMATIC S7 F Systems Software Media Package (software download and online Certificate of License)
Note:
Email address required!

6ES7833-1CC36-0YE5

6ES7833-1CC36-0YK5

SIMATIC S7 F Systems V6.2 Upgrade Package

For SIMATIC S7 F Systems upgrade from V6.0/V6.1 to V6.2

2 languages (English, German), software class A, runs on the engineering station under Windows 7 SP1 64-bit (Professional, Enterprise, Ultimate) or Windows Server 2008 R2 SP1 Standard 64-bit; on the operator station additionally under Windows 7 SP1 32-bit (Enterprise, Ultimate), Windows 10 Enterprise 2015 LTSC 64-bit or Windows Server 2012 R2 Standard 64-bit (see SIMATIC S7 F Systems V6.2 Readme for latest information), Floating License for 1 user

Without SIMATIC PCS 7 Software Media Package

- Goods delivery
License key on USB flash drive and Certificate of License, bundled with 1 x SIMATIC S7 F Systems Software Media Package per order item
- Online delivery
License key download and online Certificate of License combined with SIMATIC S7 F Systems Software Media Package (software download and online Certificate of License)
Note:
Email address required!

6ES7833-1CC26-0YE5

6ES7833-1CC26-0YK5

Update/upgrade packages

Updates/Upgrades Asynchronous to the PCS 7 Version

Upgrades for Safety Integrated for Process Automation

Ordering data	Article No.	Ordering data	Article No.
<p>SIMATIC S7 Safety Matrix Tool</p> <p>SIMATIC S7 Safety Matrix Tool V6.3 Upgrade Package V6.x -> V6.3</p> <p>2 languages (English, German), software class A, runs on Windows 7 SP1 (Enterprise/Ultimate), Windows 10 Enterprise LTSB 2015, Windows Server 2008 R2 SP1, Windows Server 2012 R2, Windows Server 2016</p> <p>Floating License for 1 user</p> <p>Without SIMATIC PCS 7 Software Media Package</p> <ul style="list-style-type: none"> • Goods delivery License key on USB flash drive and Certificate of License, bundled with 1 x SIMATIC S7 Safety Matrix Software Media Package per order item • Online delivery License key download and online Certificate of License, combined with SIMATIC S7 Safety Matrix Software Media Package (software download and online Certificate of License) <p><u>Note:</u> Email address required!</p>	<p>6ES7833-1SM03-0YE5</p> <p>6ES7833-1SM03-0YK5</p>	<p>SIMATIC S7 Safety Matrix Viewer</p> <p>SIMATIC S7 Safety Matrix Viewer V6.3 Upgrade Package V6.x -> V6.3</p> <p>2 languages (English, German), software class A, Runs on Windows 7 SP1 (Enterprise/Ultimate), Windows 10 Enterprise LTSB 2015, Windows Server 2008 R2 SP1, Windows Server 2012 R2, Windows Server 2016</p> <p>Floating License for 1 user</p> <p>Without SIMATIC PCS 7 Software Media Package</p> <ul style="list-style-type: none"> • Goods delivery License key on USB flash drive and Certificate of License, bundled with 1 x SIMATIC S7 Safety Matrix Software Media Package per order item • Online delivery License key download and online Certificate of License, combined with SIMATIC S7 Safety Matrix Software Media Package (software download and online Certificate of License) <p><u>Note:</u> Email address required!</p>	<p>6ES7833-1SM63-0YE5</p> <p>6ES7833-1SM63-0YK5</p>

Update/upgrade packages

Updates/Upgrades Asynchronous to the PCS 7 Version

Upgrades for S7-PLCSIM Simulation Software

Overview

The S7-PLCSIM software used for simulation of SIMATIC PCS 7 automation systems when debugging CFC/SFC user programs can be integrated into the Engineering System, i.e. into the configuration environment of SIMATIC PCS 7. The version cycle of S7-PLCSIM is asynchronous to the version cycle of SIMATIC PCS 7.

S7-PLCSIM as of V5.4 SP8 Upd1 is compatible with SIMATIC PCS 7 V9.1

With the compatibility tool on the Internet you can determine which S7-PLCSIM versions are suitable for the various SIMATIC PCS 7 versions:

<https://support.industry.siemens.com/cs/ww/en/view/64847781>

Ordering data

S7-PLCSIM Upgrade from V3.x, V4.x, V5.0, V5.2 or V5.3 to V5.4 (incl. SP)

5 languages (English, German, French, Italian, Spanish), software class A, runs with Windows 7 Ultimate 32/64-bit, Windows Server 2003/2003 R2 Standard 32-bit or Windows Server 2008 R2 Standard 64-bit, floating license for 1 user

Without SIMATIC PCS 7 Software Media Package

Goods delivery
License key on USB flash drive, certificate of license, software and electronic documentation on CD

Article No.

6ES7841-0CC05-0YE5

Overview

With SIMATIC PCS 7, communications software and licenses of SIMATIC NET are used for the system communication via Industrial Ethernet. Their version cycle is not usually synchronous with that of SIMATIC PCS 7.

The SIMATIC PCS 7 versions correspond to the SIMATIC NET products as follows:

- SIMATIC PCS 7 V9.1 with SIMATIC NET products V16
- SIMATIC PCS 7 V9.0 with SIMATIC NET products V14
- SIMATIC PCS 7 V8.2 with SIMATIC NET products V13

When upgrading SIMATIC PCS 7, the BCE and Hardnet-IE bundle licenses are included with the PCS 7 upgrade packages (for ES and OS). REDCONNECT and SOFTNET licenses must be purchased separately.

Ordering data**Article No.****Article No.****Communication products for SIMATIC PCS 7 V9.1****SIMATIC NET HARDNET-IE S7 V16**

Software for S7, open communication, OPC, PG/OP communication, configuration software, up to 120 connections, floating license

Runtime software, software and electronic manual on DVD, license key on USB stick, Class A, 2 languages (English, German) for

64 Bit: Windows 7 SP1 Professional/Enterprise/Ultimate, Windows 10 Professional/Enterprise Version 1809, 1903

Windows Server 2012 R2 Update (Standard Edition), Windows Server 2016 (Standard Edition, Datacenter), Windows Server 2019 (Standard Edition, Enterprise)

- Goods delivery
Software and electronic manual on CD, license key on USB flash drive
- Online delivery
Software and license key download
Note:
Email address required!

6GK1716-1CB16-0AA0**6GK1716-1CB16-0AK0****SIMATIC NET HARDNET-IE S7-REDCONNECT V16**

incl. OPC Server and HARDNET IE-S7

Software for fail-safe S7 communication, floating license

Runtime software, software and electronic manual on DVD, License key on USB stick, Class A, 2 languages (English, German) for

64 Bit: Windows 7 SP1 Professional/Enterprise/Ultimate, Windows 10 Professional/Enterprise Version 1809, 1903

Windows Server 2012 R2 Update (Standard Edition), Windows Server 2016 (Standard Edition, Datacenter), Windows Server 2019 (Standard Edition, Enterprise)

- Goods delivery
Software and electronic manual on CD, license key on USB flash drive
- Online delivery
Software and license key download
Note:
Email address required!

6GK1716-0HB16-0AA0**6GK1716-0HB16-0AK0****SIMATIC NET HARDNET-IE S7-REDCONNECT PowerPack V16**

For expansion of HARDNET-IE S7 V15 communication software to HARDNET-IE S7-REDCONNECT, floating license

License key on USB stick, Class A, 2 languages (English, German) for

64 Bit: Windows 7 SP1 Professional/Enterprise/Ultimate, Windows 10 Professional/Enterprise Version 1809, 1903

Windows Server 2012 R2 Update (Standard Edition), Windows Server 2016 (Standard Edition, Datacenter), Windows Server 2019 (Standard Edition, Enterprise)

- Goods delivery
Software and electronic manual on CD, license key on USB flash drive
- Online delivery
Software and license key download
Note:
Email address required!

6GK1716-0HB16-0AC0**6GK1716-0HB16-0AK1****SIMATIC NET SOFTNET-IE RNA V16**

Redundant network access, network access software for PRP network structures with integrated SNMP, floating license

Runtime software, software and electronic manual on DVD, License key on USB stick, Class A, 2 languages (English, German) for

64 Bit: Windows 7 SP1 Professional/Enterprise/Ultimate, Windows 10 Professional/Enterprise Version 1809, 1903

Windows Server 2012 R2 Update (Standard Edition), Windows Server 2016 (Standard Edition, Datacenter), Windows Server 2019 (Standard Edition, Enterprise)

6GK1711-1EW16-0AA0

Update/upgrade packages

Notes



- 17/2 Lifecycle Services**
- 17/3 Lifecycle Management Suite
- 17/4 Managed System Services
- 17/5 Preventive System Analysis
- 17/6 Remote Services for Process Instrumentation
- 17/7 Inventory Baseline Services
- 17/8 SIMATIC System Audit
- 17/9 Lifecycle Information Services
- 17/10 Asset Optimization Services
- 17/11 Legacy System Services
- 17/12 DCS Application Services
- 17/13 Lifecycle Service Contracts

- 17/15 Technology Services**
- 17/15 SIMATIC Virtualization as a service
- 17/17 SIMATIC DCS / SCADA infrastructure
- 17/19 SIMATIC Software Platform as a Service
- 17/20 Power Control Integration Services

Services for SIMATIC PCS 7

Lifecycle Services

Overview

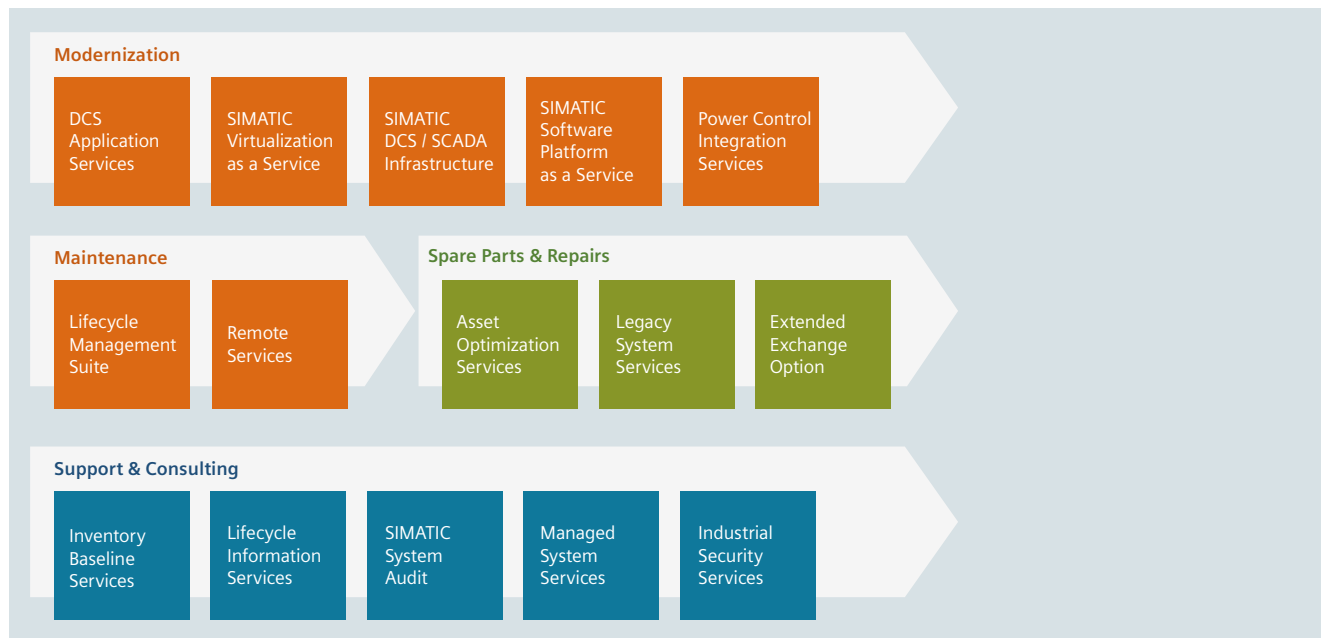

The service capability of your process control system is the key success criterion when it comes to making operating costs predictable and optimizing them continuously, to protect investments and thus ensure plant availability.

Reactive, proactive and preventive lifecycle services therefore ensure the service capability of the process control system in modern plants at optimized costs throughout the entire lifecycle.

The high pressure for innovation, especially through the use of IT systems that are constantly being upgraded, requires regular modernizations - even in automation. Only process control systems that can be updated/upgraded throughout their entire lifecycle can keep pace with the ongoing development of system technology at reasonable costs.

The requirements and specifications for operation of a plant are very specific, especially with a service life of 15 years and more. The service requirements are just as diverse. The SIMATIC PCS 7 Lifecycle Services provide an efficient service program for everything to do with the SIMATIC PCS 7 control system. These services can be easily integrated into individual service contracts that are customized to meet your specific requirements.

The standardized yet still flexible structure of the SIMATIC PCS 7 Lifecycle Services offers a future-proof basis for:

- Protection of your investments
- Securing plant availability
- Ability to calculate long-term maintenance costs
- Cost-optimized modernizations

More information

More information is available on the Internet at:

<http://www.siemens.com/PCS7LCS>

<http://www.siemens.com/pils>

Overview

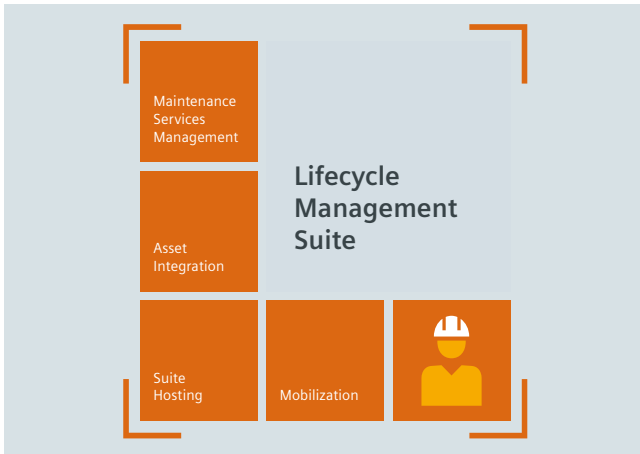

The Lifecycle Management Suite optimizes plant maintenance with regard to the planning, execution and documentation of all service activities. The pre-configured, COMOS MRO-based system provides standard operating procedures (SOP) which are assigned to the SIMATIC PCS 7 system components already entered.

"Mobilization" module – Initial setup is performed in the Mobilization module to precisely determine

- the products and systems used and their lifecycle status
- the existing maintenance processes and plant documentation

The execution of this module is a prerequisite and therefore an integral component for all further configuration modules.

"Suite Hosting" module – This module contains the COMOS MRO hosting – cloud-based or on-premises – with support and Software Update Service.

Option: Integration of the SIPIX Service Tablet

"Asset Integration" module – In addition to the "Suite Hosting" module, this module contains

- the integration of the installed base (iBase)
- the product master data entered
- the availability of obsolescence information

Option: Analyzer integration (automatic checkpoints) Reports: Lifecycle Information Services | Trends

"Maintenance Services Management" module – In addition to the "Asset Integration" module, this module contains the integration of standard operation procedures for lifecycle services, for instance, service checkpoints that have to be performed regularly. Together with the imported project data and parts lists from SIMATIC PCS 7 installations, service work schedules can be automatically generated on this basis.

Reports: Service SOP Reports | Trends

Benefits

- Pre-configured CMMS system with assets and service checkpoints entered
- Consistent data maintenance through integration in a data platform creates transparency and traceability
- Mobile data access on site with maintenance information and documentation in real time

Ordering data

Article No.

Modules	
Suite Hosting	9LA1110-5CA00-0AA0
Asset Integration	9LA1110-5CA00-0BA0
• Maintenance Services Management	9LA1110-5CA00-0CA0
• Product Data Integration	9LA1110-5CA00-1AA0
• Installed Base Integration	9LA1110-5CA00-1AB0
• Service Standards Integration	9LA1110-5CA00-1AC0
• Obsolescence Check	9LA1110-5CA00-1AD0
System Status Integration	9LA1110-5CA00-1AE0
Mobilization – Suite Hosting	9LA1110-5CA00-1CA0
Mobilization – Asset Integration	9LA1110-5CA00-1CB0
Mobilization – Maintenance Services Management	9LA1110-5CA00-1CC0
Additional COMOS MRO floating license	9LA1110-5CA00-1BA0
Additional COMOS MRO named user	9LA1110-5CA00-1BB0
Additional 10-hour technical support / subscription cycle	9LA1110-5CA00-1CD0
Mobile Integration	9LA1110-5CA00-1MA0

More information

More information is available online at:

www.siemens.com/lms

Services for SIMATIC PCS 7

Lifecycle Services

Managed System Services

Overview

MSS is a modular lifecycle service for end customers in the manufacturing and process industry as well as for machine builders and system integrators.

The core of this offering is a comprehensive system inventory, the central coordination of all service activities by an exclusive support manager, as well as regular reporting.

The Managed System Services are available in the following three options, which are based on the size of the system and are subject to a time limit:

MSS for Automation

- <https://mall.industry.siemens.com/mall/en/en/Catalog/Product/9LA1110-1BA00> – for max. 5 PLC/HMI systems
- <https://mall.industry.siemens.com/mall/en/en/Catalog/Product/9LA1110-1BB00> – for max. 20 PLC/HMI systems
- <https://mall.industry.siemens.com/mall/en/en/Catalog/Product/9LA1110-1BC00> – for max. 50 PLC/HMI systems

MSS for DCS

- <https://mall.industry.siemens.com/mall/en/en/Catalog/Product/9LA1110-1BG00> – for max. 20 AS/OS systems with a shortened contract period of only 6 months
- <https://mall.industry.siemens.com/mall/en/en/Catalog/Product/9LA1110-1BH00> – for max. 5 AS/OS systems
- <https://mall.industry.siemens.com/mall/en/en/Catalog/Product/9LA1110-1BJ00> – for max. 20 AS/OS systems
- <https://mall.industry.siemens.com/mall/en/en/Catalog/Product/9LA1110-1BK00> – for max. 50 AS/OS systems

MSS for Instrumentation

- <https://mall.industry.siemens.com/mall/en/en/Catalog/Product/9LA1110-1BD00> – for max. 100 field devices of the process instrumentation
- <https://mall.industry.siemens.com/mall/en/en/Catalog/Product/9LA1110-1BE00> – for max. 500 field devices of the process instrumentation
- <https://mall.industry.siemens.com/mall/en/en/Catalog/Product/9LA1110-1BF00> – for max. 1000 field devices of the process instrumentation

In addition, you can extend the MSS support by 25 hours - click <https://mall.industry.siemens.com/mall/en/en/Catalog/Product/9LA1110-1BL00> to go directly to the extension option.

More information

For more information about the service, please visit the following web page:

<https://support.industry.siemens.com/cs/ww/en/sc/4872>

Overview



Preventive System Analysis identifies potential system risks and displays the plant situation transparently. Special software tools record extensive diagnostic data and system information which are in turn analyzed using algorithms. Professional evaluation of the results by our experts round off your SIMATIC PCS 7 system assessment.

Regular evaluation of the system state, data-based inspections and automated weak-point analysis ensure optimal maintenance and avoid unplanned plant downtimes.

Benefits

- Fast data acquisition
- Intensive data analysis
- Transparent reporting

Selection and ordering data

This service includes:

- Summary, analysis and reporting of system-relevant SIMATIC diagnostic data
- Evaluation by a Siemens expert with preventive recommendations for action
- Reporting with representation of current state and recommendations

	Article No.
Preventive System Analysis	
• Single system report for a maximum of 10 systems	9LA1110-1CD00
• PSA 5 – for a maximum of 5 systems	9LA1110-1CA00
• PSA 20 – for a maximum of 20 systems	9LA1110-1CB00
• PSA 50 – for a maximum of 50 systems	9LA1110-1CC00
• PSA 75 – for a maximum of 75 systems	9LA1110-1CE00
• PSA 100 – for a maximum of 100 systems	9LA1110-1CF00

More information

Further information is available online at:
<http://www.siemens.com/psa>

Services for SIMATIC PCS 7

Lifecycle Services

Remote Services for Process Instrumentation

Overview

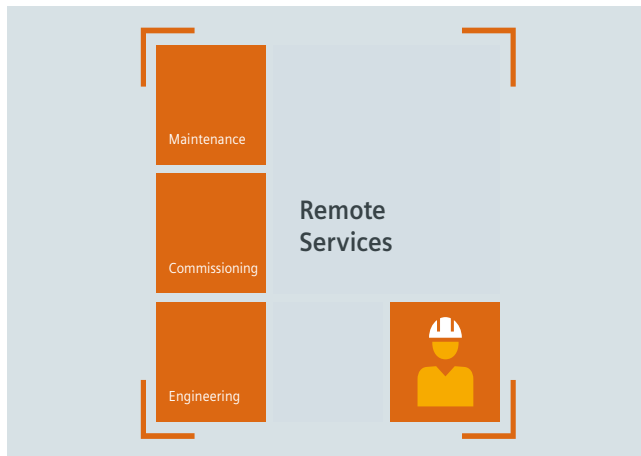

The engineering, commissioning and maintenance of automation systems involves significant amounts of both time and personnel resources, regardless of whether in a hazardous area or not. It is precisely these service tasks which can be optimally supported and even carried out remotely using powerful, modern communication media. It is imperative here that the growing IT safety requirements are met and that remote activities can be accounted for.

With our offering of platform-based remote services, our customers around the world can access centrally available expert knowledge of product manufacturers 24/7.

The 'Remote Access Services' (so-called 'connectivity packages') are required once per installation and enable communication between the customer system and Siemens IT infrastructure (cRSP = common Remote Service Platform); they consist of different hardware and software components. You can obtain detailed information from the Siemens representative in your region.

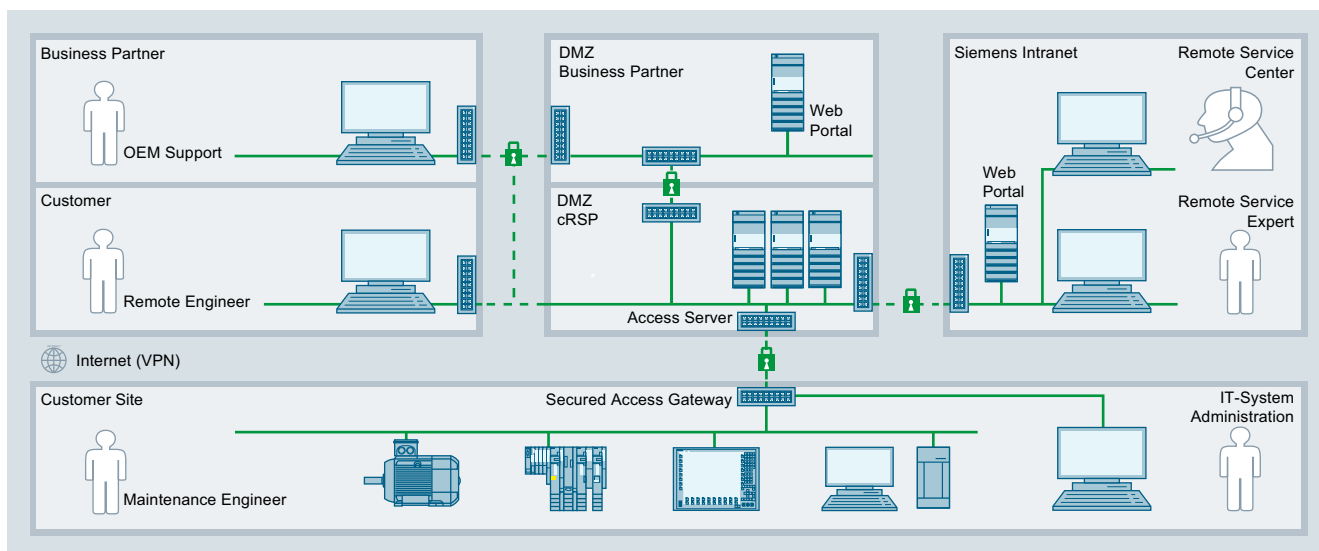

Siemens Remote Service platform

Benefits

- Secure remote connection of your automation system to the SIMATIC TechSupport IT infrastructure
- Global, direct connection to the network of the Siemens system experts
- Provision of the remote infrastructure including support and maintenance
- Complete transparency due to central administration of all system accesses
- Compatible with generally valid Industrial Security concepts
- TÜV/CERT certification of the Siemens cRSP infrastructure

Ordering data

Article No.

Modules

Reactive services over cRSP, with max. 5 solved service requests

9LA1110-1AA00

Remote services for field devices – Reactive Services 1

9LA1110-1PB00-0AA0

Remote services for field devices – Reactive Services 5

9LA1110-1PC00-0AA0

More information

More information is available online at:

<http://www.siemens.com/siremote>

Overview



The correct decisions have to be made when planning modernization measures or when budgeting necessary maintenance measures. The basis for such decisions is an in-depth knowledge of the installed system base. The requirements in this context are:

- Uniform and complete inclusion of all installed automation components
- Implement inclusion in a relatively short time and at low costs
- Make the result available through standardized reports

With its Inventory Baseline Services, Siemens offers modern data-driven services that use new methods and tools to help you plan the maintenance of machines and plants even more efficiently.

Performing an inventory provides an overview of the currently installed plant equipment and the spare parts inventory. The result of the inventory is used as a decision-making tool when planning future measures for maintenance and modernization.

Inventory Baseline Services offer transparency with regard to the installed automation components of machines and plants and provide the data for additional lifecycle services such as SIMATIC System Audit, Lifecycle Information Services and Asset Optimization Services.

Benefits

- Cost-efficient and standardized inventory of all of the installed automation components
- Valid decision aid for planned plant expansions, modernizations as well as preparation for updates/upgrades
- Solid basis for planning and implementation of additional lifecycle services

Ordering data

Article No.

Complete order processing	9LA1110-8AJ00-1AA0
Partial processing evaluation of SDT data	9LA1110-8AJ00-2AA0
Expanded data volume for large plants	9LA1110-8AJ00-4AA0

More information

More information is available online at:

<http://www.siemens.com/sibs>

Services for SIMATIC PCS 7

Lifecycle Services

SIMATIC System Audit

Overview



SIMATIC System Audit is used to analyze and evaluate the system status of SIMATIC PCS 7 systems or SIMATIC WinCC-based SCADA systems with lower SIMATIC S7 levels with regard to service capability, upgrade capability or lifecycle service contract compliance.

The modular structure allows for selective evaluation of the system status (assessment) as well as a detailed, comprehensive system analysis with fundamental statements on the current plant status and recommendations for restoration of the service and upgrade capability (audit).

Benefits

SIMATIC System Audit not only provides you with a comprehensive overview of the status of your automation system and the utilized components, it also offers a number of additional benefits:

- Competent analysis of weak points and risks with recommendations
- Avoidance or minimization of system risks for service and upgrade capability
- Reduction of standstill and downtimes by ensuring service capability
- Valid basis for the preparation of long-term lifecycle service contracts

SIMATIC System Audit is available for physical as well as virtual system configurations.

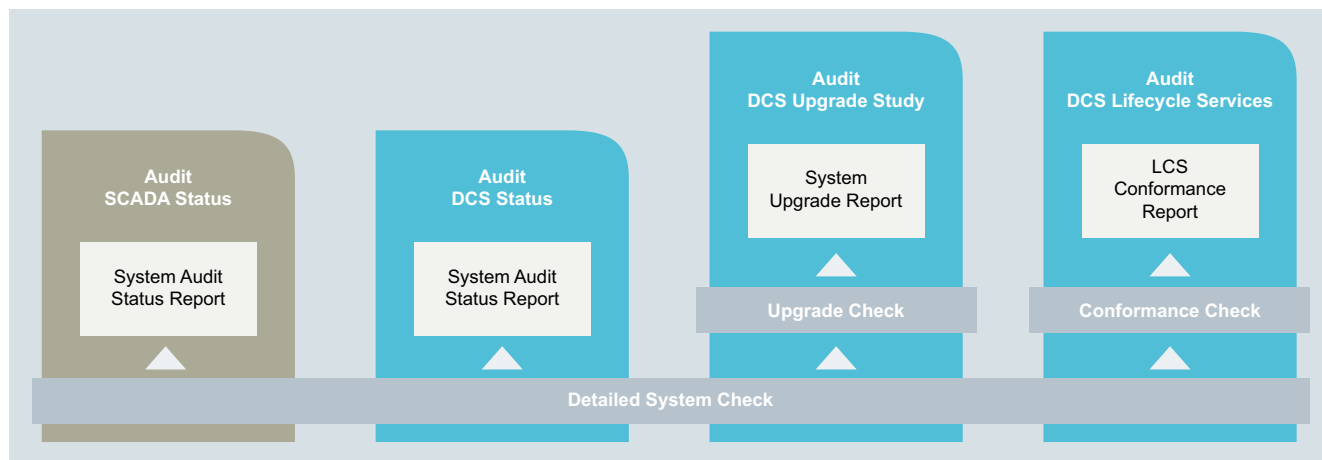

Ordering data

Article No.

SIMATIC System - Assessment DCS	9LA1110-8AC10-0AA1
SIMATIC System Audit - DCS Status	9LA1110-8AC10-4AA1
SIMATIC System DCS - Upgrade Study	9LA1110-8AC10-4AA2
SIMATIC System Audit - DCS Lifecycle Services	9LA1110-8AC10-4AA3
SIMATIC System Audit DCS - Special Configurations	9LA1110-8AC10-3AA1
SIMATIC System - Assessment SCADA	9LA1110-8AD10-0AA1
SIMATIC System Audit - SCADA Status	9LA1110-8AD10-1AA1

More information

More information is available online at:

<http://www.siemens.com/ssaa>

Overview

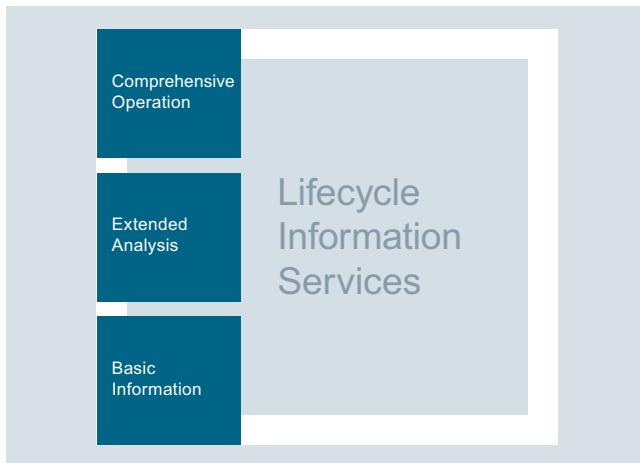

To plan your maintenance strategy, Lifecycle Information Services provide you regularly with detailed information on the product lifecycle of the utilized components.

The Lifecycle Information Services have a modular structure so that you need only request information that you actually require. Each of the following three methods returns a plant-specific report as result. You can decide for yourself how comprehensive you want this report to be.

- **Basic Information**
Product Lifecycle Status focusing on analysis of functional obsolescence
- **Extended Analysis**
"Basic Information" module and analysis of product-related statistical mean time between failures (MTBF)
- **Comprehensive Operation**
"Extended" module supplemented with plant-specific information on updates/upgrades and general recommendations

Benefits

- Proactive, regular service information on the reduction of obsolescence risks
- Securing plant availability by means of specific service recommendations
- Prevention of unscheduled downtimes or cost-intensive supply bottlenecks
- Evaluation of new technological innovations

Ordering data

Article No.

Basic Information

- Up to 50 article numbers
 - One-time service
 - Cyclically 1 × per year
 - Cyclically 2 × per year
 - Cyclically 4 × per year
- 50 to 150 article numbers
 - One-time service
 - Cyclically 1 × per year
 - Cyclically 2 × per year
 - Cyclically 4 × per year
- 150 to 300 article numbers
 - One-time service
 - Cyclically 1 × per year
 - Cyclically 2 × per year
 - Cyclically 4 × per year

9LA1110-8AG10-1AA0
9LA1110-8AG10-1AB0
9LA1110-8AG10-1AC0
9LA1110-8AG10-1AD0

9LA1110-8AG10-1BA0
9LA1110-8AG10-1BB0
9LA1110-8AG10-1BC0
9LA1110-8AG10-1BD0

9LA1110-8AG10-1CA0
9LA1110-8AG10-1CB0
9LA1110-8AG10-1CC0
9LA1110-8AG10-1CD0

Extended Analysis

- Up to 50 article numbers
 - One-time service
 - Cyclically 1 × per year
 - Cyclically 2 × per year
 - Cyclically 4 × per year
- 50 to 150 article numbers
 - One-time service
 - Cyclically 1 × per year
 - Cyclically 2 × per year
 - Cyclically 4 × per year
- 150 to 300 article numbers
 - One-time service
 - Cyclically 1 × per year
 - Cyclically 2 × per year
 - Cyclically 4 × per year

9LA1110-8AG10-2AA0
9LA1110-8AG10-2AB0
9LA1110-8AG10-2AC0
9LA1110-8AG10-2AD0

9LA1110-8AG10-2BA0
9LA1110-8AG10-2BB0
9LA1110-8AG10-2BC0
9LA1110-8AG10-2BD0

9LA1110-8AG10-2CA0
9LA1110-8AG10-2CB0
9LA1110-8AG10-2CC0
9LA1110-8AG10-2CD0

Comprehensive Operation

- Up to 50 article numbers
 - One-time service
 - Cyclically 1 × per year
 - Cyclically 2 × per year
 - Cyclically 4 × per year
- 50 to 150 article numbers
 - One-time service
 - Cyclically 1 × per year
 - Cyclically 2 × per year
 - Cyclically 4 × per year
- 150 to 300 article numbers
 - One-time service
 - Cyclically 1 × per year
 - Cyclically 2 × per year
 - Cyclically 4 × per year

9LA1110-8AG10-3AA0
9LA1110-8AG10-3AB0
9LA1110-8AG10-3AC0
9LA1110-8AG10-3AD0

9LA1110-8AG10-3BA0
9LA1110-8AG10-3BB0
9LA1110-8AG10-3BC0
9LA1110-8AG10-3BD0

9LA1110-8AG10-3CA0
9LA1110-8AG10-3CB0
9LA1110-8AG10-3CC0
9LA1110-8AG10-3CD0

More information

More information is available online at:

<http://www.siemens.com/lis>

Services for SIMATIC PCS 7

Lifecycle Services

Asset Optimization Services

Overview

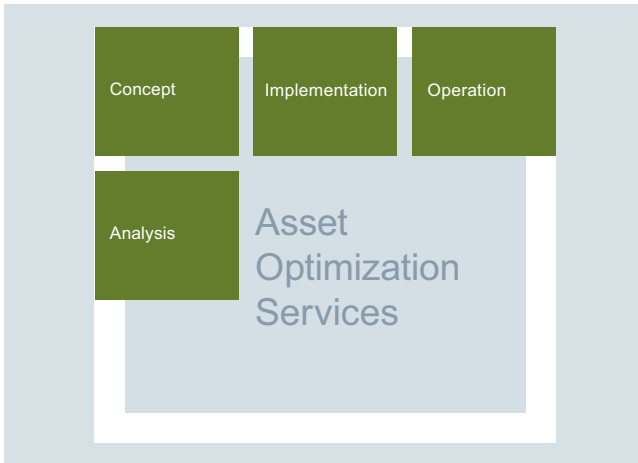

High plant availability with optimal spare part supply - Asset Optimization Services provide a structured and systematic procedure for the holistic optimization of the supply of spare parts.

The four phases of Asset Optimization Services are coordinated with each other but can also be used independently:

- Phase I: **Analysis**
Determine the current spare part situation on site: Availability, product lifecycle, spare part delivery times
- Phase II: **Concept**
The concept phase consists of an analysis of the actual requirements and the development of a spare part concept.
- Phase III: **Implementation**
Based on the results of the concept phase, necessary inventory structures and inventory locations are established and spare parts procured.
- Phase IV: **Operation**
The optimized and continuous supply of spare parts is an essential contribution to high plant availability. Depending on the specific contractual agreements, cyclic inventory analysis and a regular exchange of information also take place.

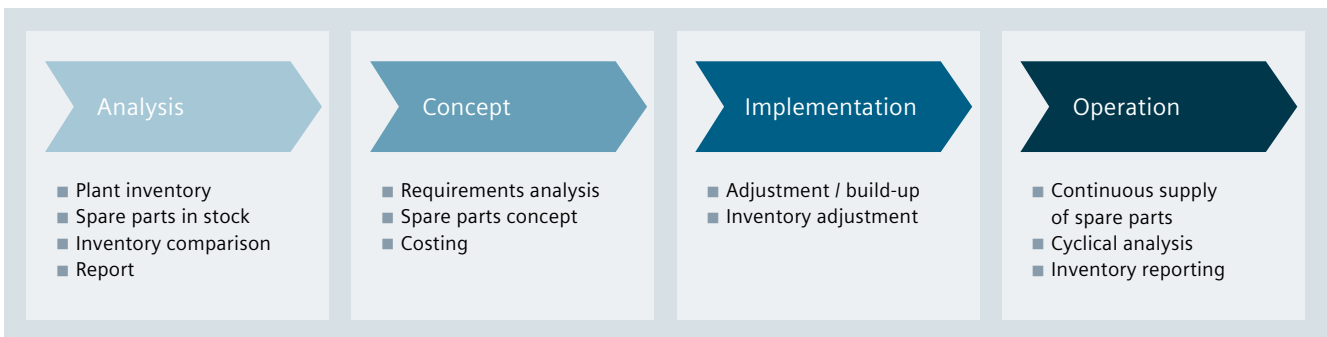

Benefits

- Creates transparency about the actual spare part requirements
- Ensures spare part availability across the entire lifecycle of the machine or plant and therefore fulfills an important prerequisite for improved service capability
- Shift to external inventory keeping and continuous supply with necessary spare parts

Ordering data

Article No.

Analysis	9LA1110-8AE10-1AA0
Concept	9LA1110-8AE10-2AA0
Implementation	9LA1110-8AE10-3AA0
Operation - Spare Parts Supply	9LA1110-8AE10-4AA0
Operation - Spare Part Management	9LA1110-8AE10-4BA0
Additional options	
Product Extension Including 500 additional article numbers in the analysis phase	9LA1110-8AE10-8AA0
Time Extension 1 additional day for analysis and concept phase	9LA1110-8AE10-8BA0

More information

More information is available online at:

<http://www.siemens.com/aos>

Overview



Legacy System Services bridge the time until a planned plant modernisation of instrumentation and control based on SIMATIC PCS 7. Selected component from the product range of obsolete SIMATIC PCS 7 versions together with technical support ensure the continued operation of an existing plant for the agreed time.

System Support module

- Contractually guaranteed access to technical support for obsolete SIMATIC PCS 7 V(n-2) components
- Specialists with the relevant technological expertise who coordinate all queries.
- System support as a necessary option for the purchase of selected discontinued system components

Product Delivery module

- Guaranteed access to components of product version SIMATIC PCS 7 V(n-2)
- Purchase using standard ordering processes and regular article numbers
- This module is only available in combination with the "System Support" module

Benefits

- **Proactive support**
Contractually guaranteed support for obsolete SIMATIC PCS 7 components – for operators and maintenance engineers – ensures continued plant operation.
- **Investment protection**
Legacy System Services give you the necessary time and financial leeway until you can implement plant modernisation.
- **Cost transparency**
Far more reliable maintenance cost planning ensures the cost-effective operation of the plant.

Ordering data

Article No.

LSS V1.0 for SIMATIC PCS 7 V6.x

System Support 5 (S)	9LA1110-8LA10-1AA0
System Support 20 (M)	9LA1110-8LA10-1AB0
System Support 50 (L)	9LA1110-8LA10-1AC0

LSS V1.1 / V1.2 for SIMATIC PCS 7 V7.x

System Support Starter	9LA1110-8LA11-1AS0
System Support S	9LA1110-8LA11-1AA0
System Support M	9LA1110-8LA11-1AB0
System Support L	9LA1110-8LA11-1AC0
Extension	9LA1110-8LA11-1AX0

LSS V1.3 for SIMATIC PCS 7 V8.0 and V8.1

System Support Starter	9LA1110-8LA13-1AS0
System Support S	9LA1110-8LA13-1AA0
System Support M	9LA1110-8LA13-1AB0
System Support L	9LA1110-8LA13-1AC0
Extension (25 hours of support)	9LA1110-8LA13-1AX0

More information

More information is available online at:

<http://www.siemens.com/lss>

Services for SIMATIC PCS 7

Lifecycle Services

DCS Application Services

Overview



Holistic DCS system modernization not only requires updating the system software, but also modernizing and standardizing the individual applications. "DCS Library Services" offers you the ideal solution for library exchange to APL:

- Standardized library exchange at a fixed price and project-specific implementation of AS and OS components
- AS/OS analysis creates transparency
- More flexible blocks and higher-level control algorithms
- Swift and secure implementation with short test phase

Benefits

Innovative – The modernization of libraries enables participation in current and future DCS innovations.

Cost-efficient – The use of a standardized library leads to reduced maintenance costs and thereby avoids unplanned service costs.

Effective – System-oriented, customized processing in accordance with a standardized procedure results in efficient solutions, even for complex tasks.

Ordering data

Article No.

Block Exchange AS Basic Package/MP	9LA1110-8DA00-3AA0
Block Exchange AS per AS 417	9LA1110-8DA00-3AD0
Block Exchange AS per AS 416	9LA1110-8DA00-3AC0
Block Exchange AS per AS 414	9LA1110-8DA00-3AB0
AS Option – Reposition CFC Blocks	9LA1110-8DA00-8AA0
AS Option – SFC Plan Parameter Exchange	9LA1110-8DA00-8AB0
AS Option – Dissolve Chart-in-Chart	9LA1110-8DA00-8AC0
Block Exchange AS Analysis 5AS	9LA1110-8DA00-1AA0
Block Exchange AS Analysis 10AS	9LA1110-8DA00-1AB0
Block Exchange AS Analysis 20AS	9LA1110-8DA00-1AC0
Block Exchange AS Analysis 30AS	9LA1110-8DA00-1AD0
Block Exchange AS Analysis 50AS	9LA1110-8DA00-1AE0
Block Exchange OS Analysis	9LA1110-8DA00-1BA0
Block Exchange OS Analysis Option Detail	9LA1110-8DA00-6BA0
DCS Modernization Flexible Use	9LA1110-8DA00-0CA0
DCS Modernization Travel Costs	9LA1110-8DA00-0CB0

More information

More information is available online at:

<http://www.siemens.com/das>

Overview



The service elements introduced in the preceding sections form the basis for customized SIMATIC PCS 7 Lifecycle Service Contracts. Additional specific contract parameters, so-called service KPIs (e.g. terms of payment) can be agreed upon individually.

A prerequisite for entering into a Lifecycle Service Contract is an in-depth knowledge of the installed system base.

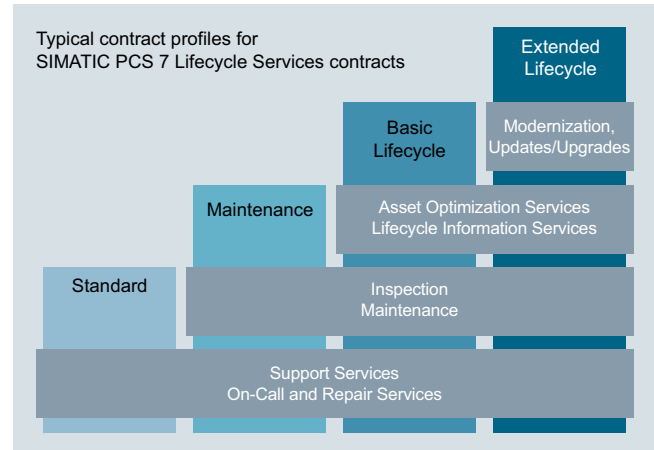

Typical variants of a Lifecycle Service contract are:

- **Standard**
mainly contains reactive service elements, such as Technical Support, on-call or even repair services
- **Maintenance**
includes the "Standard" profile with added services such as preventive inspection and maintenance
- **Basic Lifecycle**
includes the "Maintenance" profile with added Lifecycle Information Services and Asset Optimization Services
- **Extended Lifecycle**
includes the "Basic Lifecycle" profile with added comprehensive modernizations as well as updates and upgrades

Services for SIMATIC PCS 7

Lifecycle Services

Lifecycle Service Contracts

Overview (continued)

Long-term investment protection with predictable costs

A **reactive service concept** increases the risk of obsolescence – operating expenses and unplanned standstills can fluctuate and are hard to predict. The investment pressure increases until an upgrade becomes necessary. Long-term maintenance planning is extremely difficult, the risks are difficult to assess and the overall costs cannot be clearly calculated.

With a **proactive service concept**, however, the management of obsolescence risks and modernizations can be planned consistently. The continuous maintenance of the plant keeps the obsolescence risk low; the optimized costs for maintenance and modernization (OPEX) are mostly consistent and therefore predictable.

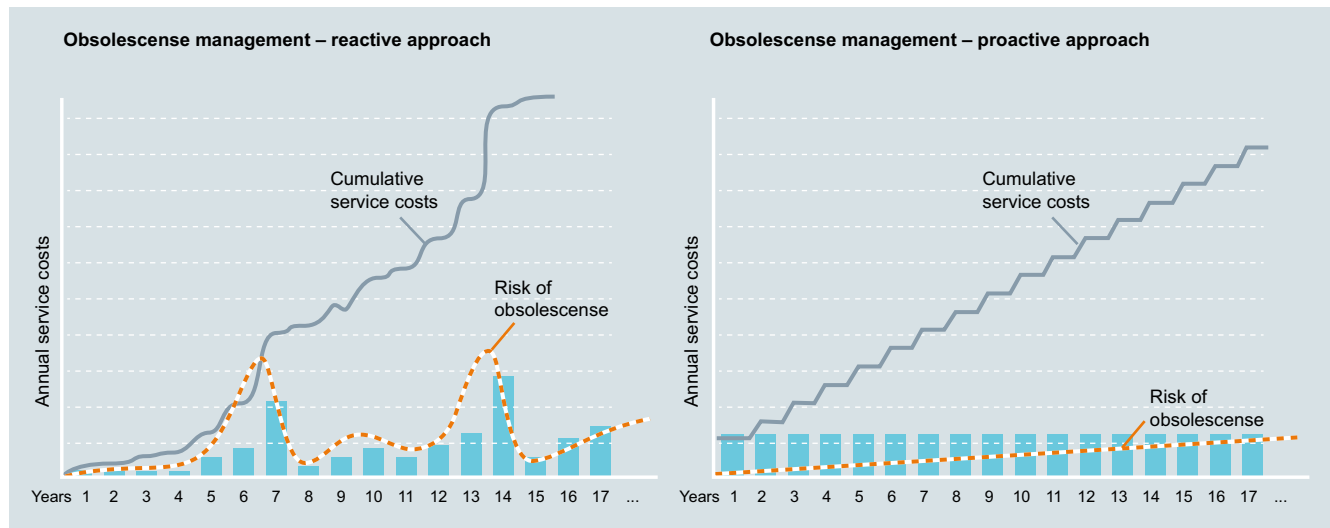

Benefits

- Long-term investment protection
- Planning capability for modernization and maintenance costs at the time of the investment across the entire lifetime of up to 15 years (TCO)
- Increased plant availability, for example, through guaranteed arrival times for service, secured spare part supply and preventive maintenance measures
- Ensure service capability through active obsolescence management for hardware and software components
- Securing system manufacturer know-how
- Professional project management from a single source for the entire duration of the contract

More information

More information is available online at:

<http://www.siemens.com/pcs7lcs>

Overview

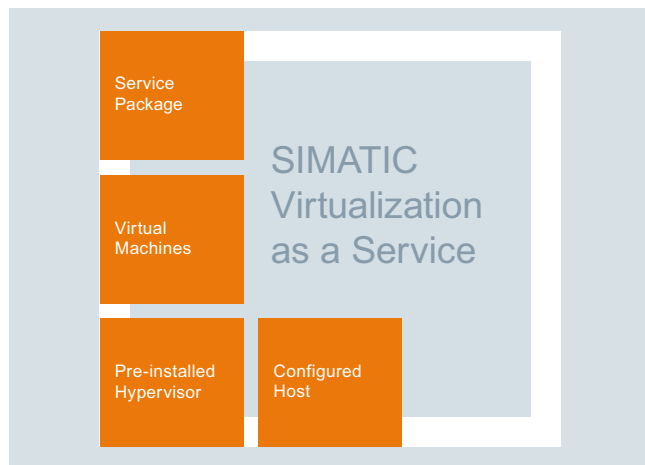

In addition to maintenance of the hardware platform, service and maintenance of the installed software components is decisive for the lifecycle costs of a PC-based control system. Together with IT technologies, innovative concepts, such as virtualization, have been introduced to the industrial environment.

A virtual system needs less hardware, space and energy. It can also be serviced and maintained from a central location. The advantages are clear: greater flexibility at lower costs.

With SIMATIC Virtualization as a Service, you receive the lifecycle service for the virtual system including the matching hardware and software components directly from a single source and perfectly coordinated with each other.

SIMATIC Virtualization as a Service includes:

- Setup of a complete virtualization host
- Configuration of the virtual machines
- Installation and configuration of the operating systems
- Installation of the SIMATIC software
- Comprehensive service package

You have the option to supplement this offer with Managed Support Services and SIMATIC Remote Services.

Benefits

- Comprehensive lifecycle services for the virtual system including hardware and software – all from a single source
- Preconfigured, ready-to-use operator and engineering stations
- Optimal use of existing hardware resources
- Simple and cost-effective system expansions and updates

Selection and ordering data

The offer comprises:

- Basic system (host hardware and installed Hypervisor software)
- Thin Client for system management
- Service package
- Range of different virtual machines (virtual machines can only be ordered in combination with a host)

You also have the option of ordering additional hardware and software components such as the VM vCenter server, the SIMATIC Batch SSD kit, additional thin clients as well as supplementary lifecycle services.

Virtual machines are subject to sliding-scale pricing.

	Article No.
Basic system for virtual machines with Windows Server 2012	
HP ProLiant DL380 GEN10 with VMware Hypervisor	
• 12Cx1P HP Host System	9LA1110-6SV00-1HB3
• 16Cx1P HP Host System	9LA1110-6SV00-1HC3
• 12Cx2P HP Host System	9LA1110-6SV00-1HE3
• 16Cx2P HP Host System	9LA1110-6SV00-1HF3
Basic system for virtual machines with Windows Server 2016	
HP ProLiant DL380 GEN10 with VMware Hypervisor + 10x Microsoft Windows Server 2016 standard licenses	9LA1110-6SV00-1HB4
12Cx1P HP Host System	
HP ProLiant DL380 GEN10 with VMware Hypervisor + Microsoft Windows Server 2016 Datacenter license	
• 16Cx1P HP Host System	9LA1110-6SV00-1HC4
• 12Cx2P HP Host System	9LA1110-6SV00-1HE4
• 16Cx2P HP Host System	9LA1110-6SV00-1HF4
Management Console	
HP T630 Flexible Thin Client dual screen – international	9LA1110-6SV00-1TA5
Win10 Emb operating system, international localization	
HP T630 Flexible Thin Client dual screen – German	9LA1110-6SV00-1TD5
Win10 Emb operating system, German localization	
vSAN system for virtual machines with Windows Server 2016	
16Cx1P HP vSAN system	9LA1110-6SV00-1HL4
HP ProLiant DL380 GEN10 with VMware Hypervisor + vSAN software + Microsoft Windows Server 2016 Datacenter license	
12Cx2P HP vSAN system	9LA1110-6SV00-1HM4
HP ProLiant DL380 GEN10 with VMware Hypervisor + vSAN software + Microsoft Windows Server 2016 Datacenter license	

Services for SIMATIC PCS 7

Technology Services

SIMATIC Virtualization as a service

Ordering data	Article No.	Ordering data	Article No.
vSAN switches		VMware software	
HPE 5130 24G switch 24x1Gbit + 6x10Gbit network switch + 1x HPE242 10Gbit DAC cable 7m	9LA1110-6SV00-1SW0	VMware vCenter Server Foundation Appliance with license	9LA1110-6SV05-0VF0
Thin Clients		VMware vCenter Server Standard Appliance with license	9LA1110-6SV05-0VS0
Win10 Emb operating system, international localization		VMware software service contract	
• HP T730 Flexible Thin Client quad screen	9LA1110-6SV00-1TB0	2 year service contract	
• HP T630 Flexible Thin Client dual screen	9LA1110-6SV00-1TA2	• For vCenter Server Foundation	9LA1 110-6SV00-1VF0
Win10 Emb operating system, German localization		• For vCenter Server Standard	9LA1 110-6SV00-1VS0
• HP T730 Flexible Thin Client quad screen	9LA1110-6SV00-1TD0	5 year service contract	
• HP T630 Flexible Thin Client dual screen	9LA1110-6SV00-1TD1	• For vCenter Server Foundation	9LA1110-6SV00-1VF1
Options		• For vCenter Server Standard	9LA1110-6SV00-1VS1
SSD Batch kit For SIMATIC PCS 7 Batch server database	9LA1110-6SV00-1BA0	Virtual machines	
DIGI Anywhere USB 19" (for SIMIT dongles)	9LA1110-6SV00-0SM0	VM with W2012 Server R2, 64-bit	9LA1110-6SV05-0AA2
Extension Service for additional virtual machines For maximum 10 VMs	9LA1110-6SV06-0AA0	VM with PCS 7 V8.2 SP1 W2012 Server R2 operating system, 64-bit	
Service contract for Basic SIVaaS System		• OS server	9LA1110-6SV05-1AB2
2 year service contract		• ES/OS client	9LA1110-6SV05-1GB3
• For 12Cx1P host	9LA1110-6SV00-1AB4	• OS client	9LA1110-6SV05-1HB2
• For 16Cx1P host	9LA1110-6SV00-1AC4	• BATCH server	9LA1110-6SV05-1LB2
• For 12Cx2P host	9LA1110-6SV00-1AE4	• BATCH client and OS client	9LA1110-6SV05-1JB2
• For 16Cx2P host	9LA1110-6SV00-1AF4	VM with WinCC V7.5 W2016 Server operating system, 64-bit	
5 year service contract		• Server	9LA1110-6SV05-2AA3
• For 12Cx1P host	9LA1110-6SV00-1AB5	• Client	9LA1110-6SV05-2BA4
• For 16Cx1P host	9LA1110-6SV00-1AC5	VM with W2016 Server, 64-bit	9LA1110-6SV05-0AA3
• For 12Cx2P host	9LA1110-6SV00-1AE5	VM with W2016 Server, 64-bit	9LA1110-6SV05-0AA4
• For 16Cx2P host	9LA1110-6SV00-1AF5	Integrate Windows license For 12Cx1P and 16Cx1P	
3 year service contract extension¹⁾		VM with PCS 7 V9.0 SP2 W2016 Server operating system, 64-bit	
• For 8Cx1P, 10Cx1P host	9LA1110-6SV00-1EB3	• OS server	9LA1110-6SV05-1AB5
• For 12Cx1P, 14Cx1P host	9LA1110-6SV00-1EC3	• ES/OS client	9LA1110-6SV05-1GB7
• For 8Cx2P, 10Cx2P, 16Cx1P host	9LA1110-6SV00-1EE3	• ES/OS client + SIPaaS account	9LA1110-6SV05-1GC0
• For 12Cx2P, 14Cx2P, 16Cx2P host	9LA1110-6SV00-1EF3	• OS client	9LA1110-6SV05-1HB5
Service contracts for vSAN system		• BATCH server	9LA1110-6SV05-1LB5
2 year service contract		• BATCH client and OS client	9LA1110-6SV05-1JB5
• For 16Cx1P vSAN host	9LA1110-6SV00-1AL4	• Route control server	9LA1110-6SV05-1MB5
• For 12Cx2P vSAN host	9LA1110-6SV00-1AM4	• Route control client	9LA1110-6SV05-1NB5
• For HPE 5130 24G switch	9LA1110-6SV00-1SW1	VM with SIMIT V10 W2016 Server operating system, 64-bit	
5 year service contract		• Simulation software	9LA1110-6SV05-0SM4
• For 12Cx2P vSAN host	9LA1110-6SV00-1AM5	• Virtual controller	9LA1110-6SV05-0SM5
• For 16Cx1P vSAN host	9LA1110-6SV00-1AL5		
• For HPE 5130 24G switch	9LA1110-6SV00-1SW3		

¹⁾ Extension of an existing 2-year service contract

More information

More information is available online at:

<http://www.siemens.com/sivaas>

Overview

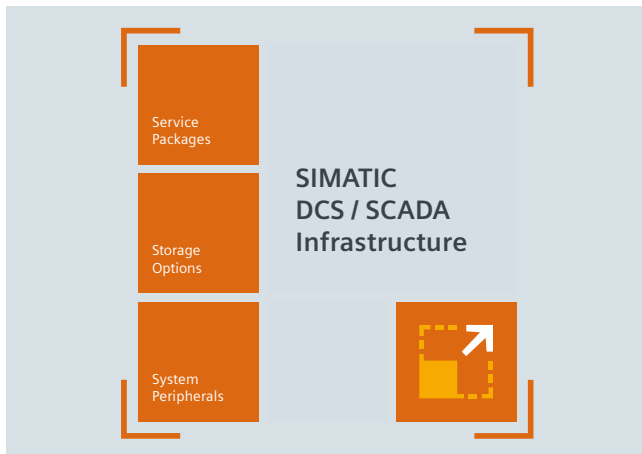

Historical data from the plant provides a central key to increased productivity. Tapping into the considerable volume of data for plant optimization requires a powerful archiving and reporting system. Siemens Industry Services supplies a comprehensive solution: an archiving system comprising server hardware and software, and process control keyboard, together with the necessary services – all from a single source.

SIMATIC DCS/SCADA infrastructure is a powerful, preconfigured IT infrastructure with preinstalled SIMATIC automation software. The hardware system is preconfigured in line with the specific requirements of the given application. The fully integrated archiving system comprises:

- A high-performance hardware platform
- Microsoft Windows Server installations and licenses
- Installation and configuration of Process Historian/Information Server software
- Optional: individual configuration for process control keyboard

This offer includes a 5-year comprehensive service package. A dedicated service contact person will provide you with professional assistance throughout the term of the contract and coordinate all support activities.

Benefits

- System configuration as required and preinstallation of software (Siemens and third-party software)
- Fully integrated long-term archiving solution for large volumes of data without additional engineering
- Plant expansion without disruption to operation
- Fast and easy access to historical plant data from an Office environment and rapid reporting
- Technical support for all components installed and for the complete system

Services for SIMATIC PCS 7

Technology Services

SIMATIC DCS / SCADA infrastructure

Selection and ordering data

The offer comprises:

- Basic server hardware, pre-installed and pre-configured
- Service package

	Article No.
System peripherals	
Process control keyboard for SIMATIC PCS 7	9AE4270-1AA00
SIDSI Process Historian	
SIDSI PH Size XS HPE Host System ProLiant DL380 Gen 10 with Windows Server Standard 2016	9LA1110-6PH13-0EA0
SIDSI PH Size S HPE Host System ProLiant DL380 Gen 10 with Windows Server Standard 2016	9LA1110-6PH13-0EB1
SIDSI PH Size M HPE Host System ProLiant DL380 Gen 10 with Windows Server Standard 2016	9LA1110-6PH13-0DB4
SIDSI PH Size L HPE Host System ProLiant DL380 Gen 10 with Windows Server Standard 2016	9LA1110-6PH13-0CA8
SIDSI PH Size BTO HPE "build to order" Host for Process Historian Configuration	On request
SIDSI Backup & Restore Servers	
SIDSI Backup & Restore - Basic - Server	9LA1110-6SP10-0AA0
SIDSI Backup & Restore - Professional - Server	9LA1110-6SP20-0AA0
SIDSI Backup & Restore - Professional - Socket - License	9LA1110-6SP20-0AB1
SIDSI Backup & Restore - Professional - Instance - License	9LA1110-6SP20-0AB2

	Article No.
Service package	
5 Year Service Agreement for SIDSI Standalone PH Hosts	9LA1110-6PH13-1SV5
5 Year Service Agreement for SIDSI Redundant PH Hosts	9LA1110-6PH13-2SV5
5 Year Service Agreement for SIDSI Backup & Restore Basic	9LA1110-6SP10-0SV5
5 Year Service Agreement for SIDSI Backup & Restore Professional	9LA1110-6SP20-1SV5
Display stands and mounts	
SIDSI Workstation Monitor 24	9LA1110-6SP10-1AA0
SIDSI Dual-Monitor Desktop Stand	9LA1110-6SP10-2AA1
SIDSI Dual-Monitor Desktop Mount	9LA1110-6SP10-2AA2
SIDSI Quad-Monitor Desktop Stand	9LA1110-6SP10-2AB1
SIDSI Quad-Monitor Desktop Mount	9LA1110-6SP10-2AB2
SIDSI Quad-Monitor Desktop Mount Horizontal	9LA1110-6SP10-2BB2
USB Connection	
SIDSI USB Connect 2 Port	9LA1110-6SP10-6AA1
SIDSI USB Connect 8 Port	9LA1110-6SP10-6AB1
SIDSI USB Connect 24 Port	9LA1110-6SP10-6AC1
Thin Client	
HPE Thin Client Dual Screen (Germany)	9LA1110-6SP10-7EA0
HPE Thin Client Dual Screen (international)	9LA1110-6SP10-7GA0
HPE Thin Client Quad Screen (Germany)	9LA1110-6SP10-7FA0
HPE Thin Client Quad Screen INT (international)	9LA1110-6SP10-7HA0

More information

More information is available online at:

<http://www.siemens.com/sidsi>

<http://www.siemens.com/sidsi-sios>

Overview

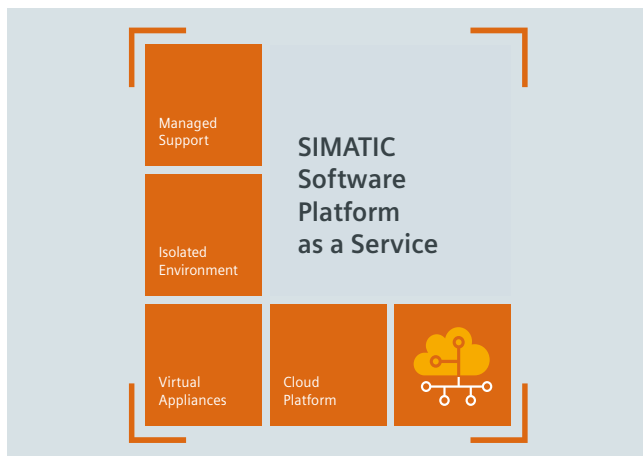

SIMATIC Software Platform as a Service provides a cloud-based IT infrastructure with preinstalled and preconfigured SIMATIC software. This engineering environment for the SIMATIC PCS 7 process control system allows short-term and flexible use for a limited period.

The virtual IT infrastructure in the data center of the cloud service provider provides all necessary resources such as computing power, memory, networks, etc. Fully configured and preinstalled virtual machines are provided in the cloud. These can also be adapted to individual need during use, for example by installing additional software.

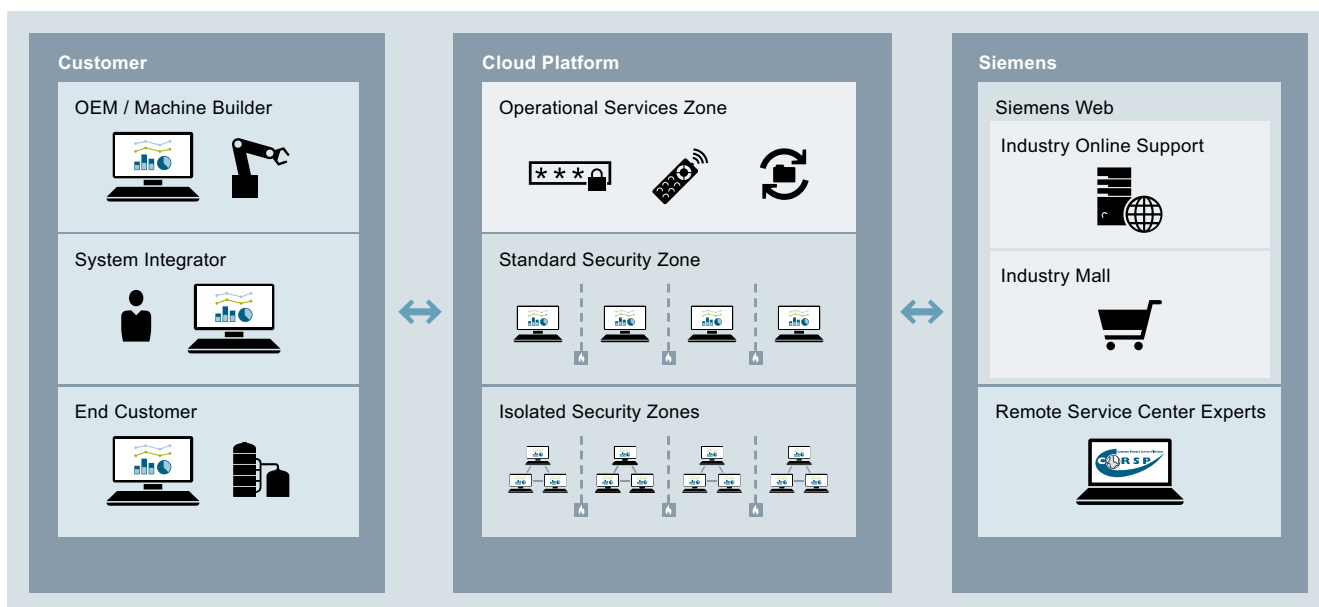

Benefits

- Thanks to the standardized testing and development environment, there are no costs for infrastructure design or configuration
- Location-independent multi-project/multi-user engineering allows the flexible use of distributed engineering resources
- A needs-based pricing model allows investment costs to be tailored to actual use

Ordering data

SIMATIC PCS 7 Virtual Appliance

- V8.1 SP1 ES / 30 days
- V8.2 ES / 30 days
- V9.0 ES / 30 days
- V9.0 SP1 ES / 30 days

Isolated security zone

Virtual Appliance – Suspend and Resume option

After 30 days, the virtual appliance can be suspended for a defined period.

Article No.

9LA1110-5SP10-1BA0
9LA1110-5SP10-1BB0
9LA1110-5SP10-1BC0
9LA1110-5SP11-1DA0

9LA1110-5SP10-1XA0

9LA1110-5SP11-1XB0

More information

More information is available online at:

www.siemens.com/sicbs

Services for SIMATIC PCS 7

Technology Services

Power Control Integration Services

Overview

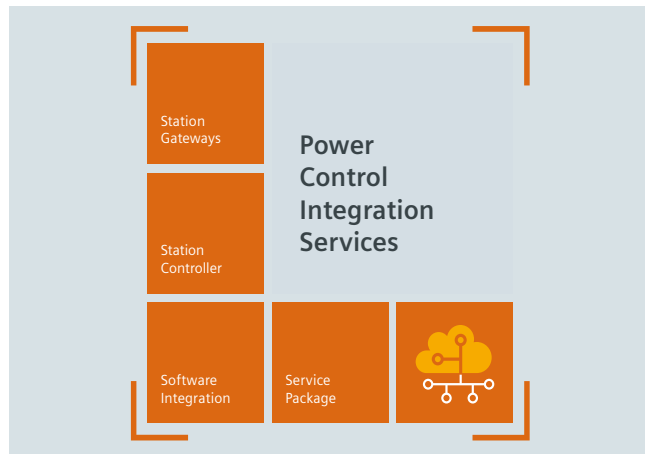

In many process plants, large electrical loads with high levels of energy consumption are in use, e.g. large drives, heavy blowers, pumps, etc. They are integrated via medium-voltage switchgear which controls, switches and automates the individual loads via devices for protection and control functions (IEDs) on the basis of the IEC 61850 standard.

SIMATIC PCS 7 PowerControl allows the homogeneous integration of switchgear in the SIMATIC PCS 7 process control system, thus creating a uniform system platform for process and energy. This platform is freely scalable – from simple visualization of the protection devices in small plants to high-availability integration of electrical loads in large plants.

Benefits

- Efficient – Cost-effective solution based on standard components (Industrial Ethernet)
- Flexible – Scalable and flexible from just a few to several hundred devices
- Lifecycle-oriented – Long-term preservation of service capability through assured spare parts availability and technical support

Ordering data

Article No.

IEC61850 Station Gateway Hardware/Software Package for 64 IEDs	9LA1110-6BC10-0AA0
IEC61850 Station Gateway Hardware/Software Package for 128 IEDs	9LA1110-6BC10-0AA1
5 year service contract Technical support, hardware replacement parts, software updates	9LA1110-6BC10-0AX0
IEC61850 Station Gateway Single Upgrade 128 IEDs	9LA1110-6BC10-0AU0
IEC61850 Station Gateway Extension Package	9LA1110-6BC10-0AE0
System architecture, feasibility study	9LA1110-6BC10-0AS0
Headquarters project support 4-hour extended support when 2-hour standard support limit exceeded	9LA1110-6BC10-0AS1

More information

More information is available online at:

<http://www.siemens.com/pcis>

Appendix



18/2	SITRAIN – Digital Industry Academy
18/3	Partners
18/3	Partners
18/4	Partners at Siemens
18/4	Siemens Partner Program
18/5	Industry Services
18/6	Industry Services – Portfolio
18/7	Online Support
18/8	Software licenses
18/10	Conditions of sale and delivery

Appendix

SITRAIN – Digital Industry Academy



Time for learning

Today's demands on our knowledge are every bit as diverse and dynamic as our profession itself. We keep learning more and longer – for our work, for our career and for ourselves. Advancing digitalization entails new topics and is also changing the way we absorb and process knowledge. SITRAIN – Digital Industry Academy offers the right source of knowledge here, which we can use anytime in just the way we need it. The time for learning is now.

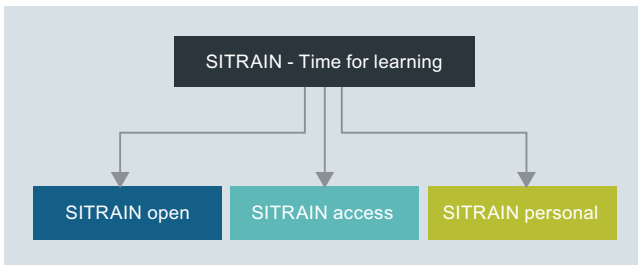

Knowledge for every need

With its three areas – SITRAIN open, SITRAIN access and SITRAIN personal – SITRAIN offers you an all-encompassing range of options for an ongoing expansion of your knowledge and skills, suited for every type of learner. And SITRAIN uses advancing digitalization to continuously expand content and offer new training methods.

Knowledge you can always find

SITRAIN open bundles useful information, worthwhile data and up-to-date expert knowledge about Siemens products for industry. Search it anytime, find anything – and always the right stuff.

Knowledge that gets you ahead

SITRAIN access is learning in the digital age. It offers you individualized ways to build your knowledge and access to exclusive digital training courses. Take advantage of sustainable learning success with a wide range of learning methods. Improve your skills – whether working in groups with others, or by yourself. Whenever, wherever and however you need to.

Knowledge you can experience

We all want to learn from the best. And SITRAIN personal's training courses let you benefit from our well-practiced trainers' expert knowledge, along with direct access to our training equipment. That's the best way to convey knowledge – whether at your company or in our training classrooms.

Find
your local
offer here



SITRAIN – Digital Industry Academy Customer Support Germany

Tel.: +49 911 895-7575

Email: sitrain.digital.industry.academy.de@siemens.com

SITRAIN – Digital Industry Academy

www.siemens.com/sitrain

- SITRAIN open:
www.siemens.com/sitrain-open
- SITRAIN access:
www.siemens.com/sitrain-access
- SITRAIN personal:
www.siemens.com/sitrain-personal

Partners at Siemens

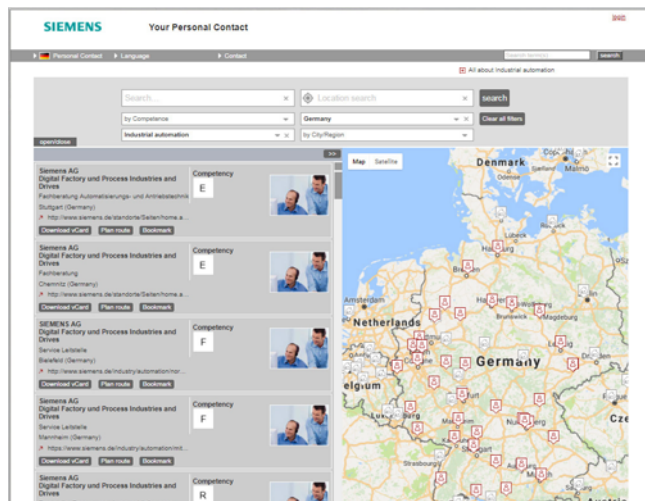

At your service locally, around the globe for consulting, sales, training, service, support, spare parts on the entire portfolio of Digital Industries.

Your partner can be found in our Personal Contacts Database at: www.siemens.com/automation-contact

You start by selecting

- the required competence,
- products and branches,
- a country and a city

or by a

- location search or free text search.

Appendix

Partners at Siemens

Siemens Partner Program

Overview

Siemens Solution and Approved Partner – Partners for your success

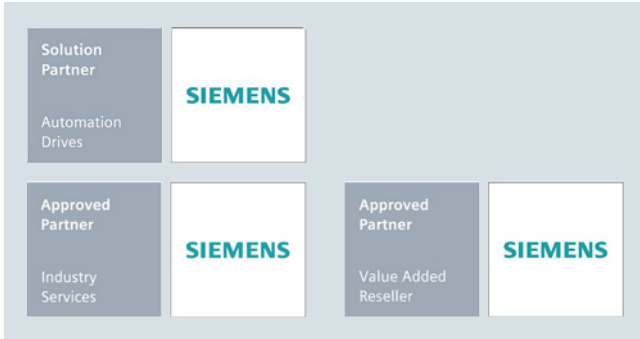

Highest competence in automation and drive technology

Siemens works closely together with selected partner companies around the world in order to ensure that customer requirements for all aspects of automation and drives are fulfilled as best as possible – wherever you are, and whatever the time.

We place great value on our customers acting in accordance with the same ideals which characterize Siemens as a whole: Competence, professionalism and quality. That is why continuous development through qualification and certification measures in line with global standards is a central aspect of our Partner Program. This means that with our partners, you benefit from the same high quality standards all over the world. The partner emblem is the symbol for tried and tested quality.

The partner network for industry

The Siemens Partner Program offers you expertise and experience close at hand.

Within our global network, we distinguish between Solution Partners and Approved Partners. We currently work with more than 1,500 Solution Partners around the world. Our network of over 150 Approved Partners continues to grow. In more than 80 countries worldwide

Siemens Solution Partner – Automation Drives



At present we are working with more than 1,500 **Solution Partners** worldwide. They are characterized by extensive application, system and sector knowledge, as well as proven project experience, and are able to implement future-proof tailored solutions of the highest quality, based on our product and system portfolio.

Siemens Approved Partner – Value Added Reseller



With their detailed technical knowledge, **Siemens Approved Partners – Value Added Resellers** offer a combination of products and services that range from specialist technologies and customized modifications to the provision of high-quality system and product packages. They also provide qualified technical support and assistance.

Siemens Approved Partner – Industry Services



Siemens Approved Partner – Industry Services put their unique expertise entirely at the service of enhancing your productivity and can be instrumental in ensuring the availability of your plants.

Partner Finder

The ideal partner for your task is just a mouse click away!

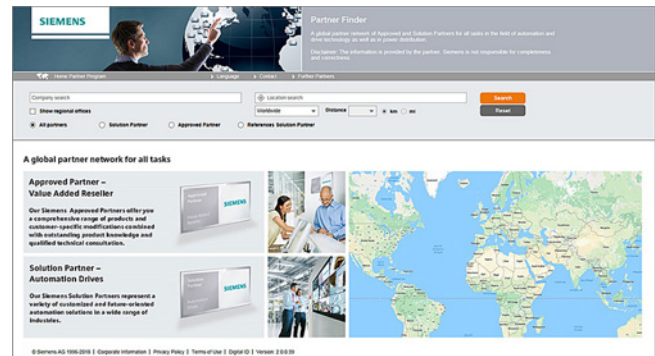

In the Siemens global Solution Partner program, customers are certain to find the optimum partner for their specific requirements – with no great effort. The Partner Finder is basically a comprehensive database that showcases the profiles of all our partners.

Easy selection:

Set filters in the search screen form according to the criteria that are relevant to you. You can also directly enter the name of an existing partner.

Skills at a glance:

Gain a quick insight into the specific competencies of any particular partner with the reference reports.

Direct contact option:

Use our electronic query form:

www.siemens.com/partnerfinder

Additional information of the Siemens Partners for industry is available online at:

www.siemens.com/partnerprogram

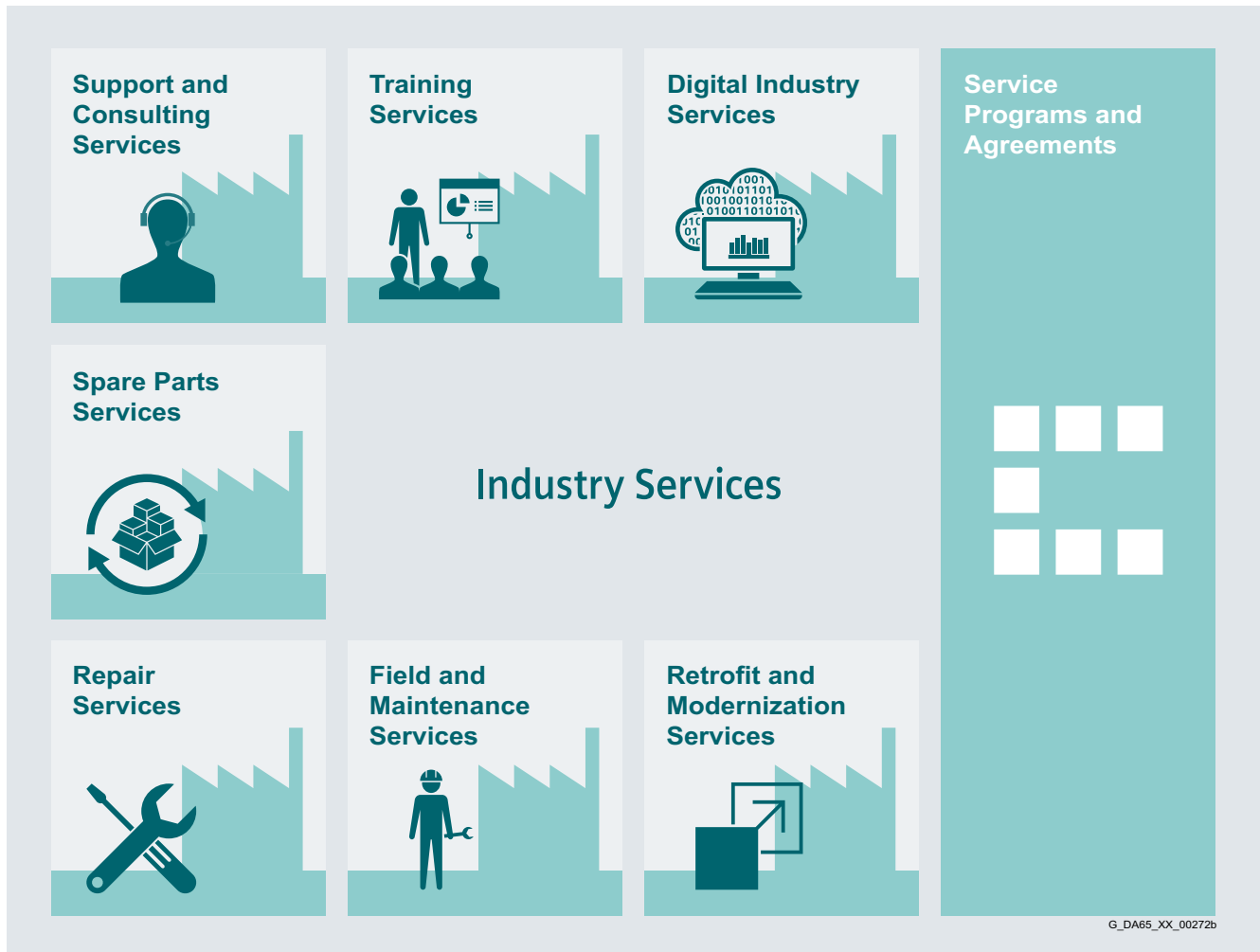
Overview

Keep your business running and shaping your digital future – with Industry Services

Optimizing the productivity of your equipment and operations can be a challenge, especially with constantly changing market conditions. Working with our service experts makes it easier. We understand your industry's unique processes and provide the services needed so that you can better achieve your business goals.

You can count on us to maximize your uptime and minimize your downtime, increasing your operations' productivity and reliability. When your operations have to be changed quickly to meet a new demand or business opportunity, our services give you the flexibility to adapt. Of course, we take care that your production is protected against cyber threats. We assist in keeping your operations as energy and resource efficient as possible and reducing your total cost of ownership. As a trendsetter, we ensure that you can capitalize on the opportunities of digitalization and by applying data analytics to enhance decision making: You can be sure that your plant reaches its full potential and retains this over the longer lifespan.

You can rely on our highly dedicated team of engineers, technicians and specialists to deliver the services you need – safely, professionally and in compliance with all regulations. We are there for you, where you need us, when you need us.

www.siemens.com/industryservices

Appendix

Industry Services

Industry Services – Portfolio overview

Overview



Digital Industry Services

Digital Industry Services make your industrial processes transparent to gain improvements in productivity, asset availability, and energy efficiency.

Production data is generated, filtered and translated with intelligent analytics to enhance decision-making.

This is done whilst taking data security into consideration and with continuous protection against cyber-attack threats.

www.siemens.com/global/en/products/services/industry/digital-industry-services.html



Training Services

From the basics and advanced to specialist skills, SITRAIN courses provide expertise right from the manufacturer – and encompass the entire spectrum of Siemens products and systems for the industry.

Worldwide, SITRAIN courses are available wherever you need a training course in more than 170 locations in over 60 countries.

<https://support.industry.siemens.com/cs/ww/en/sc/2226>



Support and Consulting Services

Industry Online Support site for comprehensive information, application examples, FAQs and support requests.

Technical and Engineering Support for advice and answers for all inquiries about functionality, handling, and fault clearance. The Service Card as prepaid support for value added services such as Priority Call Back or Extended Support offers the clear advantage of quick and easy purchasing.

Information & Consulting Services, e.g. SIMATIC System Audit; clarity about the state and service capability of your automation system or Lifecycle Information Services; transparency on the lifecycle of the products in your plants.

<https://support.industry.siemens.com/cs/ww/en/sc/2235>



Spare Parts

Spare Parts Services are available worldwide for smooth and fast supply of spare parts – and thus optimal plant availability. Genuine spare parts are available for up to ten years. Logistic experts take care of procurement, transport, custom clearance, storage and order management.

Reliable logistics processes ensure that components reach their destination as needed.

Since not all spare parts can be kept in stock at all times, Siemens offers a preventive measure for spare parts provisioning on the customer's premises with optimized **Spare Parts Packages** for individual products, custom-assembled drive components and entire integrated drive trains – including risk consulting.

Asset Optimization Services help you design a strategy for parts supply where your investment and carrying costs are reduced and the risk of obsolescence is avoided.

<https://support.industry.siemens.com/cs/ww/en/sc/2110>



Repair Services

Repair Services are offered on-site and in regional repair centers for fast restoration of faulty devices' functionality.

Also available are extended repair services, which include additional diagnostic and repair measures, as well as emergency services.

<https://support.industry.siemens.com/cs/ww/en/sc/2154>



Field and Maintenance Services

Siemens specialists are available globally to provide expert field and maintenance services, including commissioning, functional testing, preventive maintenance and fault clearance.

All services can be included in customized service agreements with defined reaction times or fixed maintenance intervals.

<https://support.industry.siemens.com/cs/ww/en/sc/2265>



Retrofit and Modernization Services

Provide a cost-effective solution for the expansion of entire plants, optimization of systems or upgrading existing products to the latest technology and software, e.g. migration services for automation systems.

Service experts support projects from planning through commissioning and, if desired over the entire extended lifespan, e.g. Retrofit for Integrated Drive Systems for an extended lifetime of your machines and plants.

<https://support.industry.siemens.com/cs/ww/en/sc/2286>



Service Programs and Agreements

A technical Service Program or Agreement enables you to easily bundle a wide range of services into a single annual or multi-year agreement.

You pick the services you need to match your unique requirements or fill gaps in your organization's maintenance capabilities.

Programs and agreements can be customized as KPI-based and/or performance-based contracts.

<https://support.industry.siemens.com/cs/ww/en/sc/2275>

Overview

Online Support – fast, intuitive, whenever you want, wherever you need



Web
www.siemens.com/online-support

App





Scan the QR code for information on our Online Support app.



- 
FAQ / Application examples
 Information about industrial products, programming and configuration as well as application examples
- 
Technical information
 Videos, documentation, manuals, updates, product notes, compatibility tool, certificates, planning data such as dimensional drawings, product data, 3D models
- 
Forum
 Exchange information and experience with other users and experts

Online Support for Siemens Industry Products

Siemens Industry and Online Support with some 1.7 million visitors per month is one of the most popular web services provided by Siemens. It is the central access point for comprehensive technical know-how about products, systems and services for automation and drives applications as well as for process industries.

In connection with the challenges and opportunities related to digitalization you can look forward to continued support with innovative offerings.

Appendix

Software licenses

Overview

Software types

Software requiring a license is categorized into types. The following software types have been defined:

- Engineering software
- Runtime software

Engineering software

This includes all software products for creating (engineering) user software, e.g. for configuring, programming, parameterizing, testing, commissioning or servicing.

Data generated with engineering software and executable programs can be duplicated for your own use or for use by third-parties free-of-charge.

Runtime software

This includes all software products required for plant/machine operation, e.g. operating system, basic system, system expansions, drivers, etc.

The duplication of the runtime software and executable programs created with the runtime software for your own use or for use by third-parties is subject to a charge.

You can find information about license fees according to use in the ordering data (e.g. in the catalog). Examples of categories of use include per CPU, per installation, per channel, per instance, per axis, per control loop, per variable, etc.

Information about extended rights of use for parameterization/configuration tools supplied as integral components of the scope of supply can be found in the readme file supplied with the relevant product(s).

License types

Siemens Industry Automation & Drive Technologies offers various types of software license:

- Floating license
- Single license
- Rental license
- Rental floating license
- Trial license
- Demo license
- Demo floating license

Floating license

The software may be installed for internal use on any number of devices by the licensee. Only the concurrent user is licensed. The concurrent user is the person using the program. Use begins when the software is started. A license is required for each concurrent user.

Single license

Unlike the floating license, a single license permits only one installation of the software per license.

The type of use licensed is specified in the ordering data and in the Certificate of License (CoL). Types of use include for example per instance, per axis, per channel, etc.

One single license is required for each type of use defined.

Rental license

A rental license supports the "sporadic use" of engineering software. Once the license key has been installed, the software can be used for a specific period of time (the operating hours do not have to be consecutive).

One license is required for each installation of the software.

Rental floating license

The rental floating license corresponds to the rental license, except that a license is not required for each installation of the software. Rather, one license is required per object (for example, user or device).

Trial license

A trial license supports "short-term use" of the software in a non-productive context, e.g. for testing and evaluation purposes. It can be transferred to another license.

Demo license

The demo license support the "sporadic use" of engineering software in a non-productive context, for example, use for testing and evaluation purposes. It can be transferred to another license. After the installation of the license key, the software can be operated for a specific period of time, whereby usage can be interrupted as often as required.

One license is required per installation of the software.

Demo floating license

The demo floating license corresponds to the demo license, except that a license is not required for each installation of the software. Rather, one license is required per object (for example, user or device).

Certificate of License (CoL)

The CoL is the licensee's proof that the use of the software has been licensed by Siemens. A CoL is required for every type of use and must be kept in a safe place.

Downgrading

The licensee is permitted to use the software or an earlier version/release of the software, provided that the licensee owns such a version/release and its use is technically feasible.

Delivery versions

Software is constantly being updated. The following delivery versions

- PowerPack
- Upgrade

can be used to access updates.

Existing bug fixes are supplied with the ServicePack version.

PowerPack

PowerPacks can be used to upgrade to more powerful software. The licensee receives a new license agreement and CoL (Certificate of License) with the PowerPack. This CoL, together with the CoL for the original product, proves that the new software is licensed.

A separate PowerPack must be purchased for each original license of the software to be replaced.

Upgrade

An upgrade permits the use of a new version of the software on the condition that a license for a previous version of the product is already held.

The licensee receives a new license agreement and CoL with the upgrade. This CoL, together with the CoL for the previous product, proves that the new version is licensed.

A separate upgrade must be purchased for each original license of the software to be upgraded.

Overview**ServicePack**

ServicePacks are used to debug existing products. ServicePacks may be duplicated for use as prescribed according to the number of existing original licenses.

License key

Siemens Industry Automation & Drive Technologies supplies software products with and without license keys.

The license key serves as an electronic license stamp and is also the "switch" for activating the software (floating license, rental license, etc.).

The complete installation of software products requiring license keys includes the program to be licensed (the software) and the license key (which represents the license).

Software Update Service (SUS)

As part of the SUS contract, all software updates for the respective product are made available to you free of charge for a period of one year from the invoice date. The contract will automatically be extended for one year if it is not canceled three months before it expires.

The possession of the current version of the respective software is a basic condition for entering into an SUS contract.

You can download explanations concerning license conditions from https://mall.industry.siemens.com/legal/ww/en/terms_of_trade_en.pdf

Appendix

Conditions of sale and delivery

1. General Provisions

By using this catalog you can purchase products (hardware, software and services) described therein from Siemens Aktiengesellschaft subject to the following Terms and Conditions of Sale and Delivery (hereinafter referred to as "T&C"). Please note that the scope, the quality and the conditions for supplies and services, including software products, by any Siemens entity having a registered office outside Germany, shall be subject exclusively to the General Terms and Conditions of the respective Siemens entity. The following T&C apply exclusively for orders placed with Siemens Aktiengesellschaft, Germany.

1.1 For customers with a seat or registered office in European Union

For customers with a seat or registered office in European Union, the following terms and conditions apply subordinate to T&C:

- for products, which include specific terms and conditions in the description text, these specific terms and conditions shall apply and subordinate thereto,
- for stand-alone software products and software products forming a part of a product or project, the "General License Conditions for Software Products for Automation and Drives for Customers with a Seat or registered Office in Germany"¹⁾ and/or
- for consulting services the "Allgemeine Geschäftsbedingungen für Beratungsleistungen der Division DF – Deutschland" (available only in German) and/or
- for other services, the „Supplementary Terms and Conditions for Services ("BL")"¹⁾ and/or
- for other supplies the "General Conditions for the Supply of Products and Services of the Electrical and Electronics Industry"¹⁾.

In case such supplies should contain Open Source Software, the conditions of which shall prevail over the "General Conditions for the Supply of Products and Services of the Electrical and Electronics Industry"¹⁾, a notice will be contained in the scope of delivery in which the applicable conditions for Open Source Software are specified. This shall apply mutatis mutandis for notices referring to other third party software components.

1.2 For customers with a seat or registered office outside European Union

For customers with a seat or registered office outside European Union, the following terms and conditions apply subordinate to T&C:

- for products, which include specific terms and conditions in the description text, these specific terms and conditions shall apply and subordinate thereto,
- for consulting services the "Standard Terms and Conditions for Consulting Services of the Division DF for Customers with a Seat or Registered Office Outside of Germany"¹⁾ and/or
- for other services the "International Terms & Conditions for Services"¹⁾ supplemented by "Software Licensing Conditions"¹⁾ and/or
- for other supplies of hard- and software the "International Terms & Conditions for Products"¹⁾ supplemented by "Software Licensing Conditions"¹⁾

1.3 For customers with master or framework agreement

To the extent our supplies and/or services offered are covered by an existing master or framework agreement, the terms and conditions of that agreement shall apply instead of T&C.

2. Prices

The prices are in € (Euro) ex point of delivery, exclusive of packaging.

The sales tax (value added tax) is not included in the prices. It shall be charged separately at the respective rate according to the applicable statutory legal regulations.

Prices are subject to change without prior notice. We will charge the prices valid at the time of delivery.

To compensate for variations in the price of raw materials (e.g. silver, copper, aluminum, lead, gold, dysprosium and neodym), surcharges are calculated on a daily basis using the so-called metal factor for products containing these raw materials.

A surcharge for the respective raw material is calculated as a supplement to the price of a product if the basic official price of the raw material in question is exceeded.

The metal factor of a product indicates the basic official price (for those raw materials concerned) as of which the surcharges on the price of the product are applied, and with what method of calculation.

An exact explanation of the metal factor can be downloaded at:

https://mall.industry.siemens.com/legal/ww/en/terms_of_trade_en.pdf

To calculate the surcharge (except in the cases of dysprosium and neodym), the official price from the day prior to that on which the order was received or the release order was effected is used.

To calculate the surcharge applicable to dysprosium and neodym ("rare earths"), the corresponding three-month basic average price in the quarter prior to that in which the order was received or the release order was effected is used with a one-month buffer (details on the calculation can be found in the explanation of the metal factor).

3. Additional Terms and Conditions

The dimensions are in mm. In Germany, according to the German law on units in measuring technology, data in inches apply only to devices for export.

Illustrations are not binding.

Insofar as there are no remarks on the individual pages of this catalog – especially with regard to data, dimensions and weights given – these are subject to change without prior notice.

¹⁾ The text of the Terms and Conditions of Siemens AG can be downloaded at
https://mall.industry.siemens.com/legal/ww/en/terms_of_trade_en.pdf

4. Export Regulations

We shall not be obligated to fulfill any agreement if such fulfillment is prevented by any impediments arising out of national or international foreign trade or customs requirements or any embargoes and/or other sanctions.

Export may be subject to license. We shall indicate in the delivery details whether licenses are required under German, European and US export lists.

Our products are controlled by the U.S. Government (when labeled with "ECCN" unequal "N") and authorized for export only to the country of ultimate destination for use by the ultimate consignee or end-user(s) herein identified. They may not be resold, transferred, or otherwise disposed of, to any other country or to any person other than the authorized ultimate consignee or end-user(s), either in their original form or after being incorporated into other items, without first obtaining approval from the U.S. Government or as otherwise authorized by U.S. law and regulations. Products labeled with "AL" unequal "N" are subject to European / national export authorization.

The export indications can be viewed in advance in the description of the respective goods on the Industry Mall, our online catalog system. Only the export labels "AL" and "ECCN" indicated on order confirmations, delivery notes and invoices are authoritative.

Products without label, with label "AL:N" / "ECCN:N", or label "AL:9X9999" / "ECCN: 9X9999" may require authorization from responsible authorities depending on the final end-use, or the destination.

If you transfer goods (hardware and/or software and/or technology as well as corresponding documentation, regardless of the mode of provision) delivered by us or works and services (including all kinds of technical support) performed by us to a third party worldwide, you shall comply with all applicable national and international (re-)export control regulations. In any event of such transfer of goods, works and services you shall comply with the (re-) export control regulations of the Federal Republic of Germany, of the European Union and of the United States of America.

Prior to any transfer of goods, works and services provided by us to a third party you shall in particular check and guarantee by appropriate measures that

- there will be no infringement of an embargo imposed by the European Union, by the United States of America and/ or by the United Nations by such transfer, by brokering of contracts concerning those goods, works and services or by provision of other economic resources in connection with those goods, works and services, also considering the limitations of domestic business and prohibitions of by-passing those embargoes;
- such goods, works and services are not intended for use in connection with armaments, nuclear technology or weapons, if and to the extent such use is subject to prohibition or authorization, unless required authorization is provided;
- the regulations of all applicable Sanctioned Party Lists of the European Union and the United States of America concerning the trading with entities, persons and organizations listed therein are considered.

If required to enable authorities or us to conduct export control checks, you, upon request by us, shall promptly provide us with all information pertaining to the particular end customer, the particular destination and the particular intended use of goods, works and services provided by us, as well as any export control restrictions existing.

You acknowledge that under the EU embargo regulations against Iran, Syria and Russia respectively the sale of certain listed goods and related services is subject to authorization by the competent export control authorities of the European Union. If (i) the goods or services ordered by you are destined for Iran, Syria or Russia, and (ii) the contract for our supplies and/or services is subject to prior authorization of the competent export control authorities of the European Union, the contract between you and us shall come into force in this respect only upon granting of such authorization.

The products listed in this catalog may be subject to European/German and/or US export regulations. Any export requiring approval is therefore subject to authorization by the relevant authorities.

Errors excepted and subject to change without prior notice.

Appendix

Notizen

Selection and ordering at Siemens Industry Mall, downloading and ordering catalogs

Easy product selection and ordering: Industry Mall

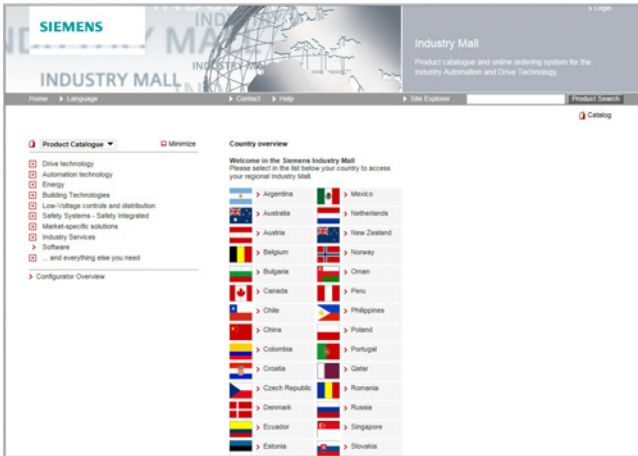

Industry Mall

The Industry Mall is a Siemens AG Internet ordering platform. It provides you with online access to a comprehensive product spectrum that is presented in an informative, well-organized way.

Powerful search functions help you select the required products, while configurators enable you to configure complex product and system components quickly and easily. CAX data are also available for you to use.

Data transfer allows the entire procedure, from selection through ordering to tracking and tracing, to be carried out online. Availability checks, individual customer discounting, and quotation preparation are also possible.

www.siemens.com/industrymall

Downloading catalogs

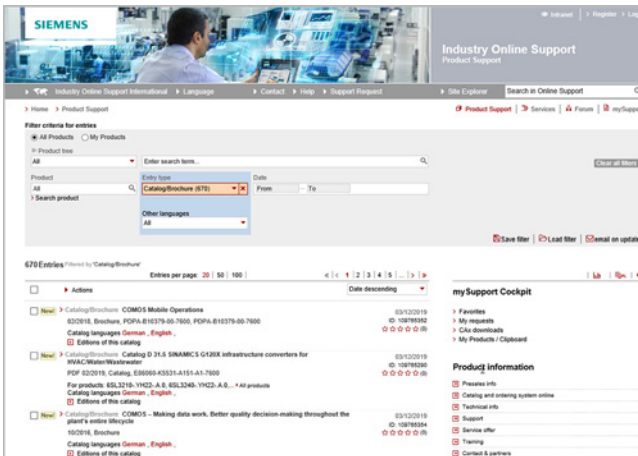

Siemens Industry Online Support

You can download catalogs and brochures in PDF format from Siemens Industry Online Support without having to register.

The filter box makes it possible to perform targeted searches.

www.siemens.com/industry-catalogs

Ordering printed catalogs



Please contact your local Siemens branch if you are interested in ordering printed catalogs.

Addresses can be found at

www.siemens.com/automation-contact

Get more information

Comprehensive information concerning the SIMATIC PCS 7 process control system:
www.siemens.com/simatic-pcs7

Published by
Siemens AG

Digital Industries
Process Automation
Östliche Rheinbrückenstr. 50
76187 Karlsruhe, Germany

PDF (E86060-K4678-A111-C8-7600)
KG 0921 596 En
Produced in Germany
© Siemens 2021

The information provided in this brochure contains merely general descriptions or characteristics of performance which in case of actual use do not always apply as described or which may change as a result of further development of the products. An obligation to provide the respective characteristics shall only exist if expressly agreed in the terms of contract. Availability and technical specifications are subject to change without notice.

All product designations may be trademarks or product names of Siemens AG or supplier companies whose use by third parties for their own purposes could violate the rights of the owners.

Security information

Siemens provides products and solutions with industrial security functions that support the secure operation of plants, systems, machines and networks.

In order to protect plants, systems, machines and networks against cyber threats, it is necessary to implement – and continuously maintain – a holistic, state-of-the-art industrial security concept. Siemens' products and solutions constitute one element of such a concept.

Customers are responsible for preventing unauthorized access to their plants, systems, machines and networks. Such systems, machines and components should only be connected to an enterprise network or the internet if and to the extent such a connection is necessary and only when appropriate security measures (e.g. firewalls and/or network segmentation) are in place.

For additional information on industrial security measures that may be implemented, please visit
<https://www.siemens.com/industrialsecurity>

Siemens' products and solutions undergo continuous development to make them more secure. Siemens strongly recommends that product updates are applied as soon as they are available and that the latest product versions are used. Use of product versions that are no longer supported, and failure to apply the latest updates may increase customer's exposure to cyber threats.

To stay informed about product updates, subscribe to the Siemens Industrial Security RSS Feed under
<https://www.siemens.com/industrialsecurity>